

Critical Release Notice

Publication number: 297-2621-814
Publication release: Standard 14.02

The content of this customer NTP supports the
SN07 (DMS) software release.

Bookmarks used in this NTP highlight the changes between the UCS15 baseline and the current release. The bookmarks provided are color-coded to identify release-specific content changes. NTP volumes that do not contain bookmarks indicate that the UCS15 baseline remains unchanged and is valid for the current release.

Bookmark Color Legend

Black: Applies to new or modified content for UCS15 that is valid through the current release.

Red: Applies to new or modified content for UCS17 that is valid through the current release.

Blue: Applies to new or modified content for UCS18 (SN05 DMS) that is valid through the current release.

Green: Applies to new or modified content for SN06 (DMS) that is valid through the current release.

Purple: Applies to new or modified content for SN07 (DMS) that is valid through the current release.

Attention!

Adobe® Acrobat® Reader™ 5.0 or higher is required to view bookmarks in color.

Publication History

January 2005

Standard release 14.02 for software release SN07 (DMS).

There are no updates for this release.

September 2004

Preliminary release 14.01 for software release SN07 (DMS). Updates made for this release are shown below.

297-2621-814 vol. 1

OM group FCDRALGR

OM group FCDRTMP1

OM group FCDRTMP2

March 2004

Standard release 13.03 for software release SN06 (DMS). Updates made for this release are shown below.

297-2621-814 vol. 1

OM group FCDRALGR

DCA references changed/made obsolete

September 2003

Standard release 13.02 for software release SN06 (DMS). Updates made for this release are shown below.

297-2621-814 vol. 1

OM group BCTPOOL

OM group BCTTANDM

OM group IS4TOPS

297-2621-814 vol. 2

OM group SERVBLK

OM group TRK
OM group UPSNACT

June 2003

Preliminary release 13.01 for software release SN06 (DMS).
New critical release notice added for this release.

This page is intentionally left blank

297-2621-814

Digital Switching Systems

UCS DMS-250

Operational Measurements Reference Manual (Volume 1
of 2)

UCS15 Standard 10.03 May 2001

Digital Switching Systems

UCS DMS-250

Operational Measurements Reference Manual (Volume 1 of 2)

Publication number: 297-2621-814

Product release: UCS15

Document release: Standard 10.03

Date: May 2001

© 1998-2001 Northern Telecom

All rights reserved.

United States of America

NORTHERN TELECOM CONFIDENTIAL: The information contained herein is the property of Nortel Networks and is strictly confidential. Except as expressly authorized in writing by Nortel Networks, the holder shall keep all information contained herein confidential, shall disclose the information only to its employees with a need to know, and shall protect the information, in whole or in part, from disclosure and dissemination to third parties with the same degree of care it uses to protect its own confidential information, but with no less than reasonable care. Except as expressly authorized in writing by Nortel Networks, the holder is granted no rights to use the information contained herein.

Nortel Networks, the Nortel Networks logo, the Globemark, How the World Shares Ideas, and Unified Networks are trademarks of Nortel Networks.

Contents

Publication history	vii
About this document	xiii
1 Operational measurement groups	1-1
OM group AMA	1-4
OM group ANN	1-13
OM group APOCCS	1-21
OM group APSYS	1-27
OM group ASUFBUS	1-40
OM group ASUMEMUT	1-53
OM group BLUEBSTR	1-57
OM group C7GTLNK	1-59
OM group C7GTWSCR	1-65
OM group C7GWSCCP	1-91
OM group C7HSLAL1	1-94
OM group C7HSLAL2	1-102
OM group C7HSLATM	1-116
OM group C7HSLCAR	1-122
OM group C7LINK1	1-135
OM group C7LINK2	1-161
OM group C7LINK3	1-184
OM group C7LINK4	1-200
OM group C7LKSET	1-207
OM group C7LPP	1-212
OM group C7LPP2	1-234
OM group C7MTP	1-242
OM group C7MTPRES	1-251
OM group C7ROUTE	1-256
OM group C7ROUTE2	1-272
OM group C7ROUTER	1-281
OM group C7RTESET	1-289
OM group C7SCCP	1-295
OM group C7SCCPCO	1-315
OM group C7SCCPX	1-327
OM group CAINAGOM	1-334
OM group CAINAGOM2	1-347
OM group CAINIP	1-355
OM group CAINLNP	1-366

OM group CAINMGR2 1-372
OM group CAINMGS2 1-379
OM group CAINMSGR 1-389
OM group CAINMSGS 1-401
OM group CAINNCRS 1-415
OM group CAINOM 1-417
OM group CAINTRI2 1-427
OM group CAINTRIG 1-440
OM group CAINUIF 1-455
OM group CBK 1-461
OM group CDR250 1-468
OM group CF3P 1-470
OM group CF6P 1-486
OM group CM 1-495
OM group CP 1-516
OM group CP2 1-536
OM group CPUSTAT 1-554
OM group CSL 1-567
OM group DAISGEN 1-575

OM group DCM 1-598
OM group DCMEBSS 1-609
OM group DCRDEST 1-613
OM group DCRICTRK 1-621
OM group DCRLINK 1-626
OM group DCRMISC 1-634
OM group DDU 1-644
OM group DRM 1-651
OM group DS1CARR 1-653
OM group DSPRMAN 1-665
OM group DUTLGEN 1-682
OM group EACARR 1-688
OM group EADLD 1-696
OM group EATSMS 1-698
OM group ECANRMAN 1-705
OM group EIUETHER 1-717
OM group ENETMAT 1-723
OM group ENETOCC 1-742
OM group ENETPLNK 1-750
OM group ENETSYS 1-761
OM group ESUP 1-776
OM group EXNDINV 1-783
OM group EXT 1-798
OM group FBTRAFF 1-807
OM group FCDRALGR 1-817
OM group FCDRLOG 1-821
OM group FCDRTMP1 1-824
OM group FCDRTMP2 1-834
OM group FLEXDIAL 1-844

OM group FLEXTYPE	1-846
OM group FPDABM	1-855
OM group FPDEVICE	1-858
OM group FPSCSI	1-869
OM group FTAM	1-877
OM group FTROM	1-884
OM group FTRQ	1-888
OM group HDBOM	1-896
OM group IOC	1-898
OM group IOSYS	1-907
OM group ISDD	1-910
OM group ISUPCGRP	1-923
OM group ISUPCKTA	1-929
OM group ISUPCONG	1-937
OM group ISUPCONN	1-941
OM group ISUPERRS	1-953
OM group ISUPUSAG	1-968
OM group LIDBCCV	1-977
OM group LMD	1-994
OM group LMSCPUST	1-1020
OM group LMSMEM	1-1026
OM group LOGS	1-1032
OM group M20CARR1	1-1038
OM group M20CARR2	1-1046
OM group MACHCONG	1-1066

Publication history

November 2000

Standard release 09.02 for UCS14 software release.

September 2000

Preliminary release 09.01 for UCS14 software release. A60008668 provides the following updates:

- Added register FAMINF2 to OM group CAINMGR2.
- Added register FAMAINFO to OM group CAINMSGR.
- Added registers AINRSVD1, AINRSVD2, AINRSVD3, AINRSVD4, LAMAFAIL, LAMAREXH, AINT1TO, and AINT1ATO to OM group CAINOM.
- Added registers SPAREBLK and SPAREOVFL to OM group TFREE533.

Added the EADLD OM group (A60008434).

Added the SERVACT OM group (A60008542)

July 2000

Standard release 08.02 for UCS13 software release.

March 2000

Preliminary version 08.01 for UCS13 software release. The CAINGOM2, CAINMGR2, CAINMGS2, and CAINTRI2 OMs were added for UCS13 software release based on A60007631. The following OMs were updated for UCS13 software release based on A60007631:

- CAINAGOM
- CAINMSGR
- CAINMSGS

- CAINTRIG
- CAINLNP
- CAINOM
- MULTAUTH
- NPAPEG
- OFF250
- TFREE533
- VAMPACG

February 2000

Standard version 07.02 for UCS12 software release.

August 1999

Preliminary version 07.01 for software release UCS12.

June 1999

Draft version 07.01 for UCS12 software release. The CDR250 OM was updated for UCS12 software release based on A60006696.

May 1999

Standard version 03.02 for UCS11 software release. The issue/version for UCS11 software was released with the 297-2631 documentation suite.

The CDR250, TFREE533, and the CAINNCRS OMs were edited for the UCS11 software release.

About this document

When to use this document

This document describes the Operational Measurements (OMs) for the UCS DMS-250 switch.

Intended audience

This document is intended for use by operating company personnel who need to obtain OMs data for the UCS DMS-250 switch.

What is in this document

This document consists of two volumes and contains the following information:

- Volume 1, OM Groups AMA-MACHONG
- Volume 2, OM Groups MPCBASE-XPMOVL

How to check the version and issue of this document

The version and issue of the document are indicated by numbers, for example, 01.01.

The first two digits indicate the version. The version number increases each time the document is updated to support a new software release. For example, the first release of a document is 01.01. In the next software release cycle, the first release of the same document is 02.01.

The second two digits indicate the issue. The issue number increases each time the document is revised but rereleased in the same software release cycle. For example, the second release of a document in the same software release cycle is 01.02.

To determine which version of this document applies to the software in your office and how documentation for your product is organized, check the release information in *Master Index of Publications*, 297-2621-001.

References in this document

This document refers to *UCS DMS-250 Billing Records Application Guide*, 297-2621-395.

Text for some OM groups within this document refers to specific data schema tables or logs. For additional information about data schema tables, refer to the *UCS DMS-250 Data Schema Reference Manual*, 297-2621-851. For additional information about logs, refer to the *UCS DMS-250 Logs Reference Manual*, 297-2621-840.

What precautionary messages mean

The types of precautionary messages used in NT documents include attention boxes and danger, warning, and caution messages.

An attention box identifies information that is necessary for the proper performance of a procedure or task or the correct interpretation of information or data. Danger, warning, and caution messages indicate possible risks.

Examples of the precautionary messages follow.

ATTENTION - Information needed to perform a task

ATTENTION

If the unused DS-3 ports are not deprovisioned before a DS-1/VT Mapper is installed, the DS-1 traffic will not be carried through the DS-1/VT Mapper, even though the DS-1/VT Mapper is properly provisioned.

DANGER - Possibility of personal injury



DANGER

Risk of electrocution

Do not open the front panel of the inverter unless fuses F1, F2, and F3 have been removed. The inverter contains high-voltage lines. Until the fuses are removed, the high-voltage lines are active, and you risk being electrocuted.

WARNING - Possibility of equipment damage

**WARNING****Damage to the backplane connector pins**

Align the card before seating it, to avoid bending the backplane connector pins. Use light thumb pressure to align the card with the connectors. Next, use the levers on the card to seat the card into the connectors.

CAUTION - Possibility of service interruption or degradation

**CAUTION****Possible loss of service**

Before continuing, confirm that you are removing the card from the inactive unit of the peripheral module. Subscriber service will be lost if you remove a card from the active unit.

How commands, parameters, and responses are represented

Commands, parameters, and responses in this document conform to the following conventions.

Input prompt (>)

An input prompt (>) indicates that the information that follows is a command:

```
>BSY
```

Commands and fixed parameters

Commands and fixed parameters that are entered at a MAP terminal are shown in uppercase letters:

```
>BSY CTRL
```

Variables

Variables are shown in lowercase letters:

```
>BSY CTRL ctrl_no
```

The letters or numbers that the variable represents must be entered. Each variable is explained in a list that follows the command string.

Responses

Responses correspond to the MAP display and are shown in a different type:

FP 3 Busy CTRL 0: Command request has been submitted.

FP 3 Busy CTRL 0: Command passed.

1 Operational measurement groups

OM group descriptions

OM group descriptions are arranged alphabetically according to group name. Each group description includes one or more flow charts and a description of each register in the group. Each volume begin with this introductory chapter and restarts with page 1.

This manual uses the following standard headings to describe OM groups:

- OM description
- Release history
- Registers
- Group structure
- Associated OM groups
- Associated functional groups
- Associated functionality codes

OM description

This section provides an expanded acronym followed by a description of what the group counts and how you can use this data.

Release history

This section shows the software release in which the group was created and lists the releases in which it subsequently changed.

Registers

This section shows the registers in the group as they appear on a MAP display.

Group structure

This section describes the number of OM tuples, key fields, information fields, office parameters, tables, and other datafill information that pertains to the group.

Associated OM groups

This section lists related OM groups and describes the relationship.

Associated functional groups

This section lists the DMS products in which the OM group applies.

Associated functionality codes

This section lists related Nortel Networks feature package numbers and their titles.

Flow charts

A flow chart shows the sequence of events that causes the registers to be incremented and the relationship between the registers within the group. Usage registers are shown in separate flow charts. Flow charts always begin on the second page of the group description.

The following symbols are used in the flow charts:

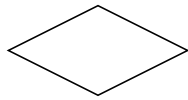

indicates a yes/no decision



indicates an activity

Register descriptions

Register descriptions are arranged alphabetically within each group. Registers are of three kinds:

- *Peg* registers are incremented when an event occurs.
- *Usage* registers record activities or states at time intervals of 10 or 100 seconds.
- *High-water* registers reflect the maximum number of items in simultaneous use during the current transfer period.

Each register is described using the following standard headings:

- Register name
- Register name release history
- Associated registers

- Associated logs
- Extension register

Register name

This section provides an expanded acronym followed by a description of what the register counts.

If the description includes reference to registers from a different group, these are identified by the group name followed by an underscore and the register name. For example, OFZ_ORGFSET refers to register ORGFSET in the group OFZ.

Register name release history

This section shows the software release in which the register was created and lists the releases in which it subsequently changed.

Associated registers

This section lists related registers and describes their relationship. This section can include formulas or useful equations. Registers from a different group are identified by a combination of the group name and register name, separated by an underscore: for example, OFZ_ORGFSET.

Associated logs

This section lists log reports that the switch generates with the events that are counted or that are otherwise related to the interpretation of the OM data.

Extension register

This section provides the name of the register that holds OM data when the original register is full. To get an accurate total count, multiply the value in the extension register by 65536 and add the original register value.

OM group AMA

OM description

Automatic message accounting summary (AMA)

The OM group AMA records:

- the total number of AMA record entries that the system generates for downstream processing
- the number of occurrences of emergency transfer between AMA tape units
- the number of times the system routes an AMA call to a Traffic Operator Position System (TOPS)

The AMA subsystem collects call data and automatically records it on a data storage device. During a call, most call processing agencies store call data in a call condense block (CCB). At call disconnect, the CCB sends the data to a buffer. The method the AMA subsystem uses to record call data is the Device-Independent Recording Package (DIRP) feature. The DIRP feature automatically assigns the AMA records to selected recording devices like disk or tape. The stored data transmits to the operating company downstream data processing center. The AMA data can be retrieved automatically as required for correct customer billing and call analysis.

Release history

The OM group AMA was created before BCS20.

Registers

The OM group AMA registers appear on the MAP terminal as follows:

AMAENT	AMAENT2	AMAEMTR	AMAFREE
AMAROUTE	AMASCRN		

Group structure

The OM group AMA provides one tuple for each office.

Key field:

There is no Key field.

Info field:

There is no Info field.

OM group AMA (continued)

Associated OM groups

The OM group EXT_EXTOVFL increases when a type of extension block is not available.

Associated functional groups

The functional group DIRP Device Independent Recording Package TOPS Traffic Operator Position System is an associated functional group of OM group AMA.

Associated functionality codes

The associated functionality codes for OM group AMA appear in the following table.

Functionality	Code
TOPS Call Processing Features	NTX030CC
Local Automatic Message Accounting (LAMA)	NTX042AA
Central Automatic Message Accounting (CAMA)	NTX044AA
IBN-Station Message Detail Recording	NTX102AA
DMS-250 Call Detail Recording Type II	NTX221AA

OM group AMA (continued)

OM group AMA registers

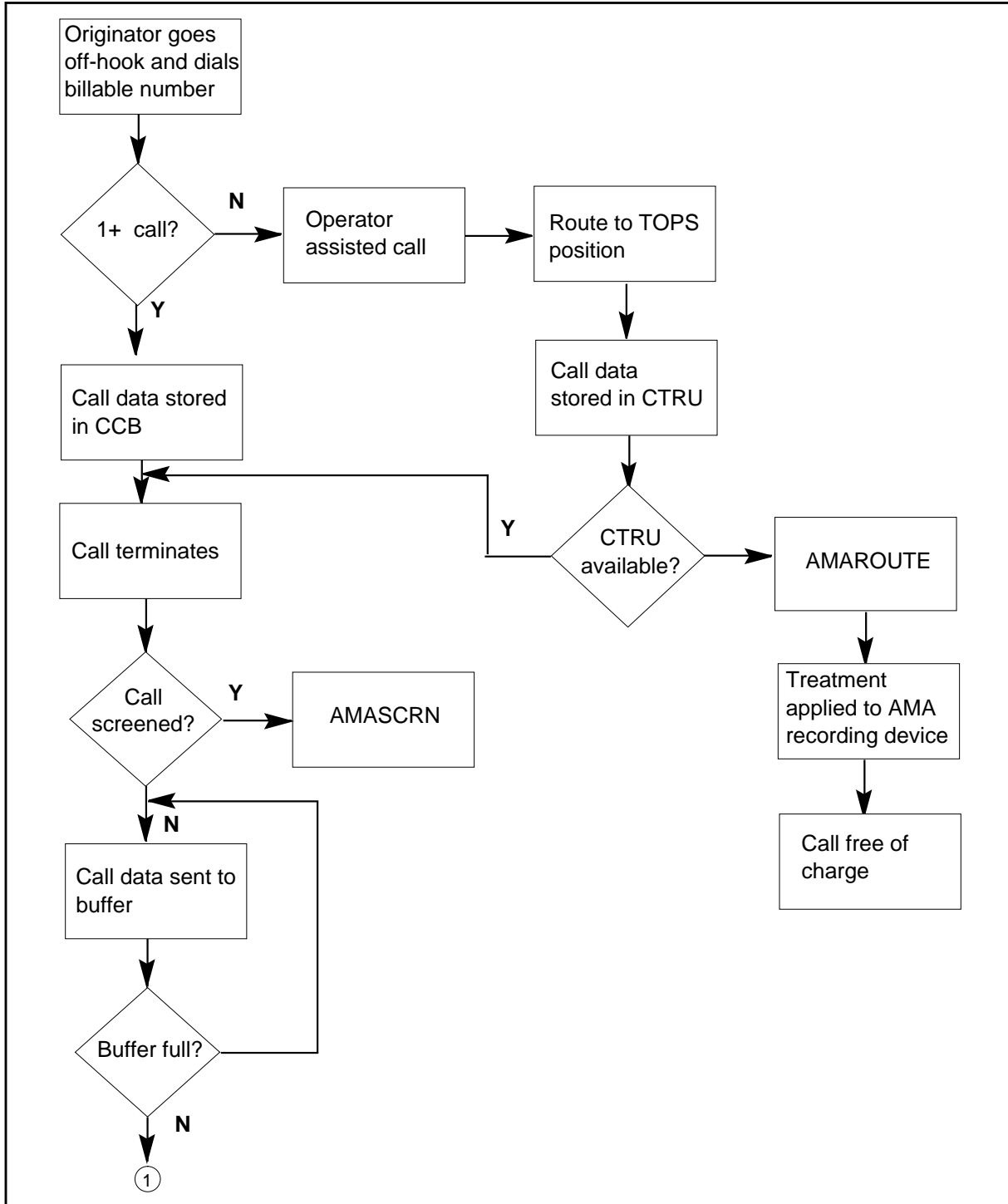

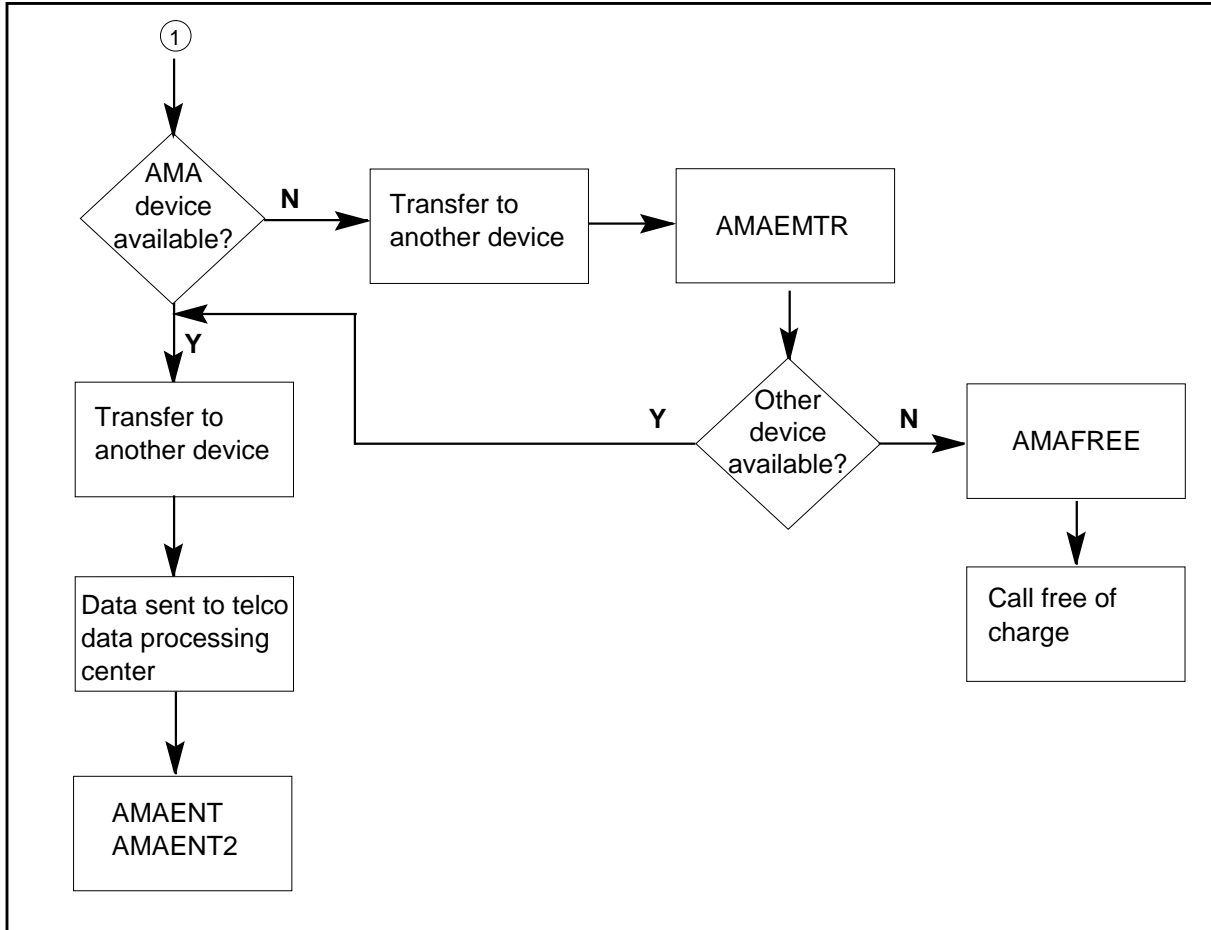
OM group AMA (continued)**OM group AMA registers (continued)****Register AMAEMTR**

AMA emergency transfer (AMAEMTR)

Register AMAEMTR counts emergency transfers between AMA tape units.

An emergency transfer occurs when an active tape unit is not present. An emergency transfer also occurs when the system cannot write a correct end-of-tape transfer record. An emergency transfer does not imply a loss of data unless the "from" or "to" tape drive number in the AMA117 log with the transfer is -1. A-1 signifies no active drive assigned before or after the transfer. In this case, the current software tape buffer, which possibly contains call data, is overwritten.

This register does not apply to DMS-250. The values are set to zero.

OM group AMA (continued)

Register AMAEMTR release history

Register AMAEMTR was introduced in BCS20

Associated registers

There are no associated registers.

Associated logs

The AMA subsystem generates AMA117. Log AMA117 contains the AMA options and the current status of the AMA options in accordance with the data in table AMAOPTS.

The DIRP subsystem generates DIRP101. Log DIRP101 indicates conditions that prevent the normal operation of DIRP and reports major DIRP events.

Extension registers

There are no extension registers.

Register AMAENT

AMA record entries (AMAENT)

Register AMAENT counts AMA record entries the system generates for downstream processing. You can identify these records as X`fx' records (x=0-6). One call generates one initial AMA record entry. TOPS calls that involve a billing number on a "hot" list or charge adjustments can generate additional initial record entries. The system generates the complete set of initial record entries (with possible intervening extension entries) for a call consecutively on a last-in, first-out basis.

This register increases when the system formats call record entries, after the call ends.

The total number of calls that are put on AMA tape or disk can be not equal to AMAENT if the AMA fails because of no devices (files).

In DMS-250 applications, this register increases when a call detail record (CDR) is made for AMA.

Register AMAENT release history

Register AMAENT was introduced in BCS20.

Associated registers

There are no associated registers.

OM group AMA (continued)

Associated logs

The AMA buffer subsystem generates AMAB100 when the system makes an AMA call entry. This subsystem generates the log only if the office parameter SPECIAL_AMA_REPORT is set to ON in office parameter tables.

The AMA buffer subsystem generates AMAB101 when the system makes a LAMA call entry. This subsystem generates the log only if parameter SPECIAL_AMA_REPORT is set to ON in office parameter tables.

The AMA buffer subsystem generates AMAB102 when the system makes an AMA call entry. This subsystem generates the log only if the office parameter SPECIAL_AMA_REPORT is set to ON in office parameter tables. This report contains TOPS entry call data.

The AMA buffer subsystem generates AMAB103 when the system makes an AMA call entry. This subsystem generates the log only if the office parameter SPECIAL_AMA_REPORT is set to ON in office parameter tables. This report contains data associated with TOPS extension record code E0 (special billing).

The AMA buffer subsystem generates AMAB104 when the system makes an AMA call entry. This subsystem generates the log only if the office parameter SPECIAL_AMA_REPORT is set to ON in office parameter tables. This report contains data associated with TOPS extension record E1 (hotel).

The AMA buffer subsystem generates AMAB105 when the system makes an AMA call entry. This subsystem generates the log only if the office parameter SPECIAL_AMA_REPORT is set to ON in office parameter tables. This report contains data associated with TOPS extension record E2 (charge).

The AMA buffer subsystem generates AMAB106 when the system makes an AMA call entry. This subsystem generates the log only if the office parameter SPECIAL_AMA_REPORT is set to ON in office parameter tables. This report contains data associated with TOPS extension record E4 (charge adjustment).

The AMA buffer subsystem generates AMAB108 when the system makes an AMA call entry. This subsystem generates the log only if the office parameter SPECIAL_AMA_REPORT is set to ON in office parameter tables. This report contains data associated with the Auxiliary Operator Services System (AOSS).

The AMA buffer subsystem generates AMAB109 when the system makes an AMA call entry. This subsystem generates the log only if the office parameter

OM group AMA (continued)

SPECIAL_AMA_REPORT is set to ON in office parameter tables. This report contains data associated with overseas calls placed through an operator.

The AMA buffer subsystem generates AMAB110 when the system makes an AMA call entry. This subsystem generates the log only if the office parameter SPECIAL_AMA_REPORT is set to ON in office parameter tables. This report contains data associated with TOPS extension record E5 (charge adjustments for calls on The AMA buffer subsystem generates 109).

The AMA buffer subsystem generates AMAB111 when the system makes an AMA call entry. This subsystem generates the log only if the office parameter SPECIAL_AMA_REPORT is set to ON in office parameter tables. This report contains data associated with domestic (B6) and international (B7) enhanced 800 service AMAB.

The DIRP subsystem generates DIRP101. Log DIRP indicates conditions that prevent normal operation of DIRP and reports major DIRP events.

Extension registers

AMAENT2

Register AMAFREE

AMA free of charge (AMA FREE)

Register AMAFREE counts AMA calls that the system routes free of charge. A call can be free of charge because recording devices or units are not available, or because of a dead process.

This register does not apply to DMS-250. All values will be set to zero.

Office parameter, AMA_FAILURE_FREE_CALL in table OFCENG is set to Y.

Register AMAFREE release history

Register AMAFREE was introduced in BCS20.

Associated registers

There are no associated registers.

Associated logs

The DIRP subsystem generates DIRP101. Log DIRP101 indicates conditions that prevent the normal operation of DIRP and reports major DIRP events.

OM group AMA (continued)

Extension registers

There are no extension registers.

Register AMAROUTE

AMA calls route to TOPS (AMAROUTE)

Register AMAROUTE increases for TOPS offices when no CAMA TOPS recording units (CTRU) are available to store call details. The AMA recording device receives an EM3 treatment application.

This register does not apply to DMS-250. Values will be set to zero.

Register AMAROUTE release history

Register AMAROUTE was introduced in BCS20.

Associated registers

Register EXT_EXTOVFL increases when a type of extension block is not available.

Associated logs

There are no associated logs.

Extension registers

There are no extension registers.

Register AMASCRN

AMA screen (AMASCRN)

Register AMASCRN pegs the number of AMA records screened.

Operating company personnel could screen an AMA record for the following reasons:

- A call disconnects before a minimum billing interval expires.
- The switch only tandems a call from an incoming to an outgoing trunk.

Register AMASCRN release history

Feature AF7556 introduced register AMASCRN in release TL010 for the DMS-100 Wireless switch.

Associated registers

There are no associated registers.

OM group AMA (end)

Associated logs

There are no associated logs.

Extension registers

There are no extension registers.

OM group ANN

OM description

Announcements (ANN)

The OM group ANN provides information on traffic for recorded announcement machines. The OM group ANN contains two peg registers (ANNATT and ANNOVFL) and three-usage registers (ANNTRU, ANNSBU, and ANNMBU). Scan rate for the usage register is 100.

All types of DMS office have ANN

Release history

The OM group ANN was introduced in BCS20

BCS33

The OMSHOW command on the ACTIVE class can convert registers ANNTRU and ANNSBU from CCS to deci-erlangs before the display of the registers.

BCS21

Software change to correct usage counts in deci-erlangs. The number of scans for each collection interval (15 min or 30 min) divides usage counts. The number of scans for each collection interval does not divide not the number of scans in 60 min.

BCS20

Software change to provide usage counts in CCS or in deci-erlangs.

Registers

The OM group ANN registers appear on the MAP terminal as follows:

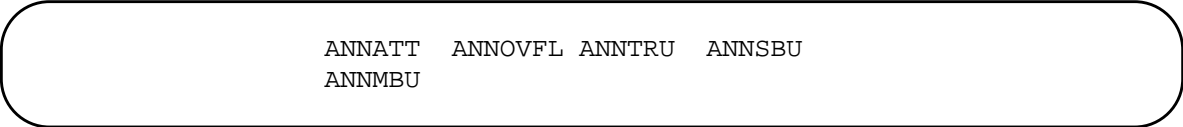

```
ANNATT  ANNOVFL  ANNTRU  ANNSBU
ANNMBU
```

Group structure

The OM group ANN provides one tuple for each announcement. A tuple consists of the five registers contained in group ANN.

Key field:

COMMON_LANGUAGE_NAME CLLI is the common-language location identifier for the announcement.

OM group ANN (continued)

Info field:

ANN_OMINFO is the maximum number of calls to be simultaneously attached to the announcement.

The fixed CLLI for ANN are as follows:

ACTSTOPS Automatic-Coin Toll Service
AOSSANN Auxiliary Operator Services System Announcement

Three tables must be entered with data: ANNS, ANNMEMS, and CNALDSPK.

Table ANNS contains the data for each announcement assigned in the switch.

The subscriber defines other CLLI.

Table ANNMEMS assigns tracks to announcements.

Table CNALDSPK identifies the trunk over which the announcement plays. The Calling Number Announcement (CNA) feature is optional. CNA can replace existing automatic number announcer circuits (ANAC).

Associated OM groups

The OM group OFZ provides information on office traffic by the intended call destination.

The OM group OTS provides information on office traffic by the accurate call destination.

Associated functional groups

There are no associated functional groups.

Associated functionality codes

The associated functionality codes for OM group ANN appear in the following table.

Functionality	Code
Common Basic	NTX001AA
OMs in Erlangs	NTX664AA

OM group ANN (continued)

OM group ANN registers

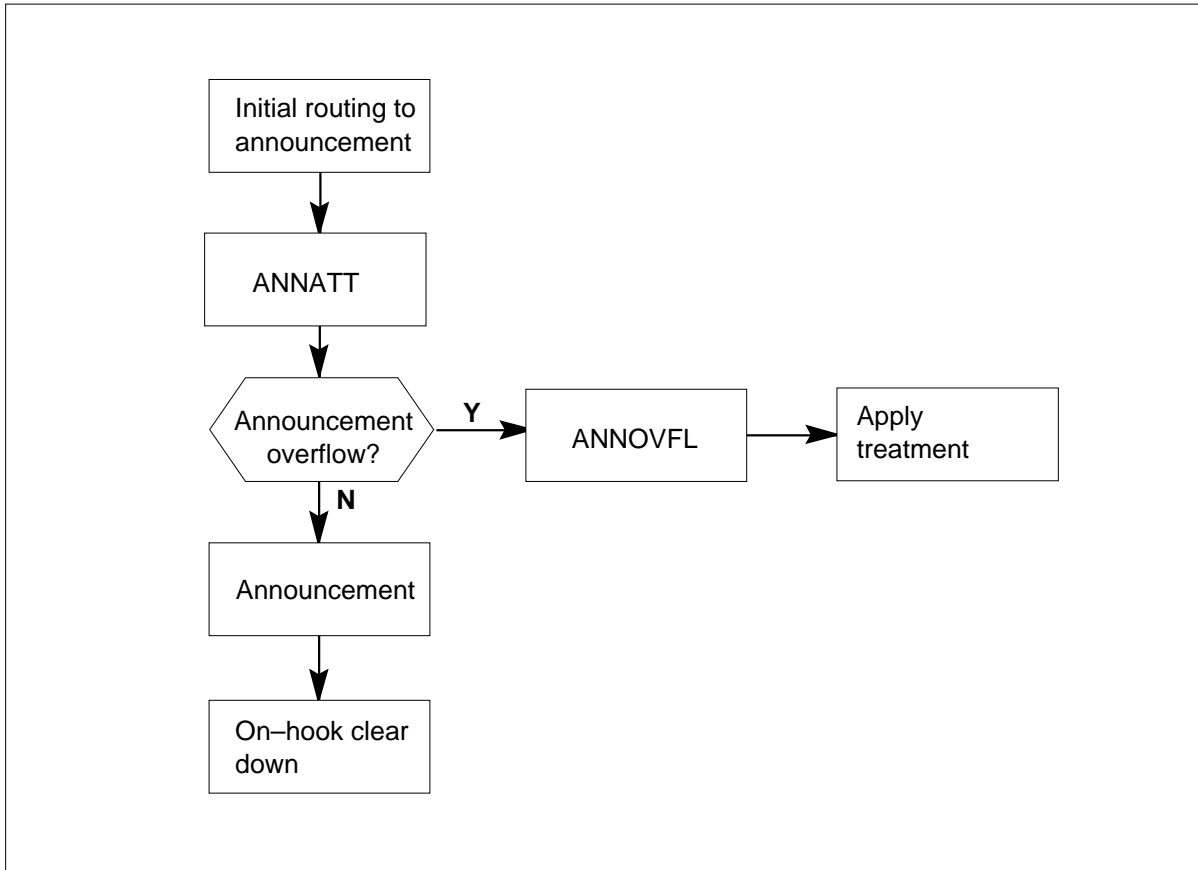

OM group ANN (continued)

OM group ANN usage registers

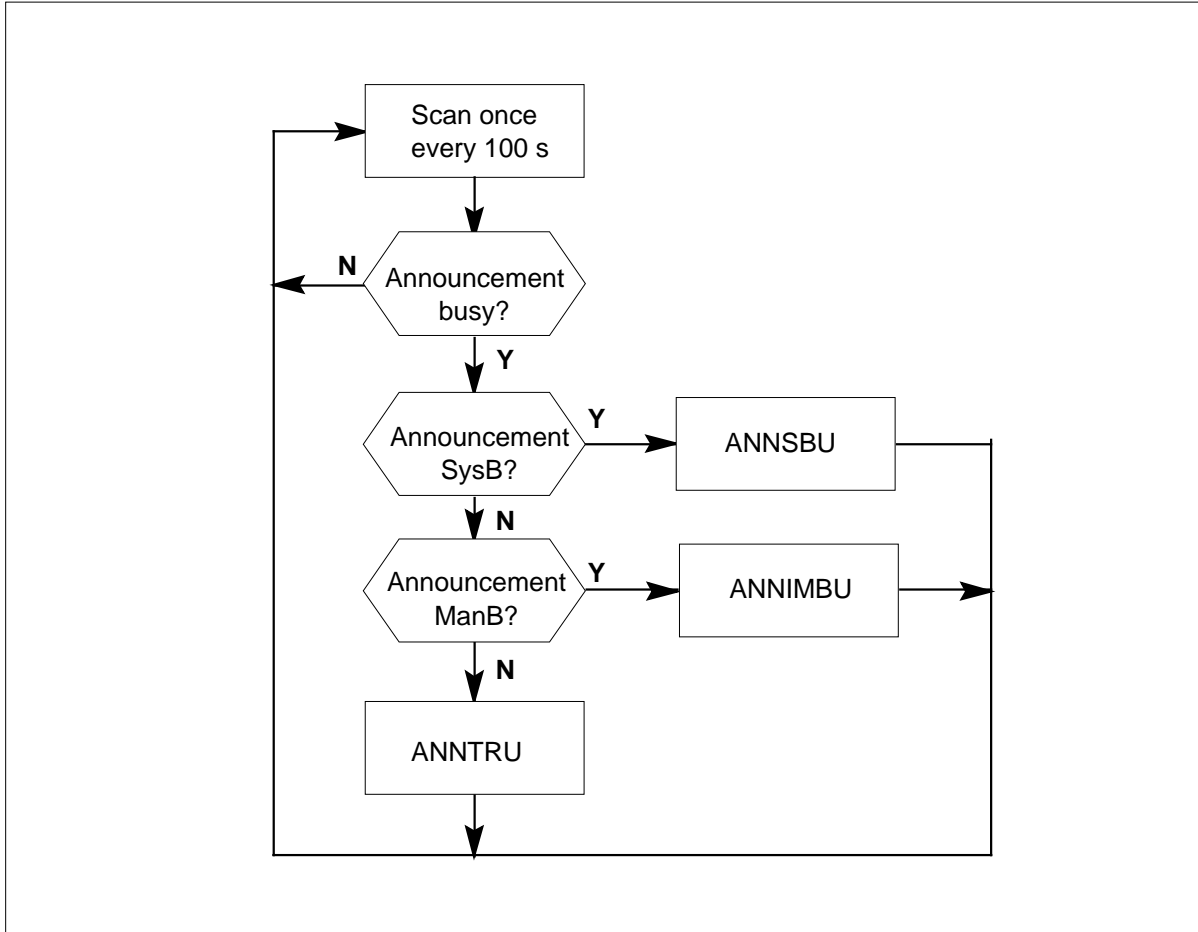

Register ANNATT

Announcement attempts (ANNATT)

Register ANNATT counts calls that route to an announcement.

Register ANNATT release history

Register ANNATT was introduced in BCS20

Associated registers

Register OFZ_INANN counts calls that originate on a trunk and the system first routes to an announcement.

Register OFZ_ORIGANN counts calls that originate on a line and the system first routes to an announcement.

OM group ANN (continued)

Registers OFZ_INANN and OFZ_ORIGANN do not count calls that the system routes to an announcement after the system first routes the calls somewhere else.

The relationship between these registers is:

$$\Sigma (\text{ANN_ANNATT}) \quad \text{OFZ_INANN} + \text{OFZ_ORIGANN}$$

ANN

Register OTS_ORGTRMT counts calls that originate on a line and the system connects to a tone or an announcement.

Register OTS_INCTRMT counts calls that originate on a trunk and the system connects to a tone or an announcement.

Register TONES_TONEATT counts attempts to connect to a tone generator.

The relationship between these registers is:

$$\Sigma (\text{ANN_ANNATT}) + \Sigma (\text{TONES_TONEATT})$$

TONES

TONES

$$\text{OTS_ORGTRMT} + \text{OTS_INCTRMT}$$

Associated logs

The line maintenance subsystem generates LINE 138 if the system routes a call to a treatment after the call is call processing busy.

The trunk maintenance subsystem generates TRK 138 if the system routes a call routes to a treatment after the call is call processing busy.

Register ANNMBU

Announcement manual busy usage (ANNMBU)

Register ANNMBU is a usage register. The scan rate is 100 s. Register ANNMBU records when an announcement is manual busy.

Each announcement consists of a minimum of one track. The system assigns each track one trunk circuit or channel. The system associates one announcement and one ANN tuple to each track. Table ANNMEMS defines

OM group ANN (continued)

the connections between tracks and announcements. Register ANNMBU measures the following busy states:

- track manual busy
- track network management (NWM) busy

Register ANNMBU release history

ANNMBU was introduced in BCS20.

BCS21

Software change to correct usage counts in deci-erlangs.

BCS20

Software change to provide usage counts in CCS or deci-erlangs.

Associated registers

Register ANNTRU records if an announcement is traffic busy.

Register ANNSBU records if an announcement is system busy.

The relationship between these registers, for each tuple, is as follows:

$$\text{TOTAL BUSY USE} = \text{ANNTRU} + \text{ANNSBU} + \text{ANNMBU}$$

Associated logs

There are no associated logs.

Register ANNOVFL

Announcement overflow (ANNOVFL)

Register ANNOVFL counts calls that the system routes to a recorded announcement, but that fail to connect to the announcement for two reasons. The maximum number of calls are connected to the announcement or the announcement is maintenance-busy. Register ANNOVFL does not count the number of calls that overflow because of network blockage.

Register ANNOVFL release history

Register ANNOVFL was introduced in BCS20.

Associated registers

There are no associated registers.

Associated logs

There are no associated logs.

OM group ANN (continued)

Register ANNSBU

Announcement system-busy use (ANNSBU)

Register ANNSBU is a usage register. The scan rate is 100 s. Register ANNSBU records when an announcement is system busy.

Each announcement uses one or more tracks. Table ANNMEMS defines the connections between tracks and announcements. The busy states that ANNSBU measures are as follows:

- track system busy
- track peripheral module busy
- queued to be manual busy

Register ANNSBU release history

Register ANNSBU was introduced in BCS20.

BCS33

When office parameter OMINERLANGS is set to Y, the usage count converts from CCS to deci-erlangs before the usage count displays. The OMSHOW command on the ACTIVE class displays usage counts. The value held in the active registers does not alter and remains in CCS.

BCS21

Software change to correct usage counts in deci-erlangs.

BCS20

Software change to provide usage counts in CCS or deci-erlangs.

Associated registers

Register ANNTRU records if an announcement is traffic busy.

Register ANNMBU records if an announcement is manual busy.

The relationship between these registers, for each tuple, is as follows:

TOTAL BUSY USAGE = ANNTRU + ANNSBU + ANNMBU

Associated logs

The system generates TRK106 if a test on trunk equipment fails.

Register ANNTRU

Announcement traffic use (ANNTRU)

OM group ANN (end)

Register ANNTRU is a use register. The scan rate is 100 s. Register ANNTRU records when an announcement is traffic busy.

Register ANNTRU release history

Register ANNTRU was introduced in BCS20.

BCS33

When office parameter OMINERLANGS is set to Y, the system converts the usage count from CCS to deci-erlangs before the display of the usage count. The OMSHOW command on the ACTIVE class displays the usage count. The value held in the active registers does not alter and remains in CCS.

BCS21

Software change to correct usage counts in deci-erlangs.

BCS20

Software change to provide usage counts in CCS or deci-erlangs.

Associated registers

Register ANNMBU records if an announcement is manual busy.

Register ANNSBU records if an announcement is system busy.

The relationship between these registers, in each tuple, is as follows:

TOTAL BUSY USE = ANNTRU + ANNSBU + ANNMBU

Associated logs

There are no associated logs.

OM group APOCCS

OM description

Application processor node system counts (APOCCS)

The OM group APOCCS measures the scheduler class on the application processor (AP) node.

Release history

The OM group APOCCS was introduced to BCS33.

Registers

The OM group APOCCS register appears on the MAP terminal as follows:

APCPOCC	APSCHEM	APFORE	APMAINT
APBKG	APIDLE	APIO	

Group structure

The OM group APOCCS provides one tuple for each sync-matched node.

Key field:

SMN_SYMB_NUM

Info field:

There is no info field

Associated OM groups

There are no associated OM groups.

Associated functional groups

The following are associated functional groups of OM group APOCCS:

- File Processor
- Line Trunk Server

OM group APOCCS (continued)

Associated functionality codes

The associated functionality code of OM group APOCCS appears in the following table.

Functionality	Code
Application Processor Base	NTXF06AA

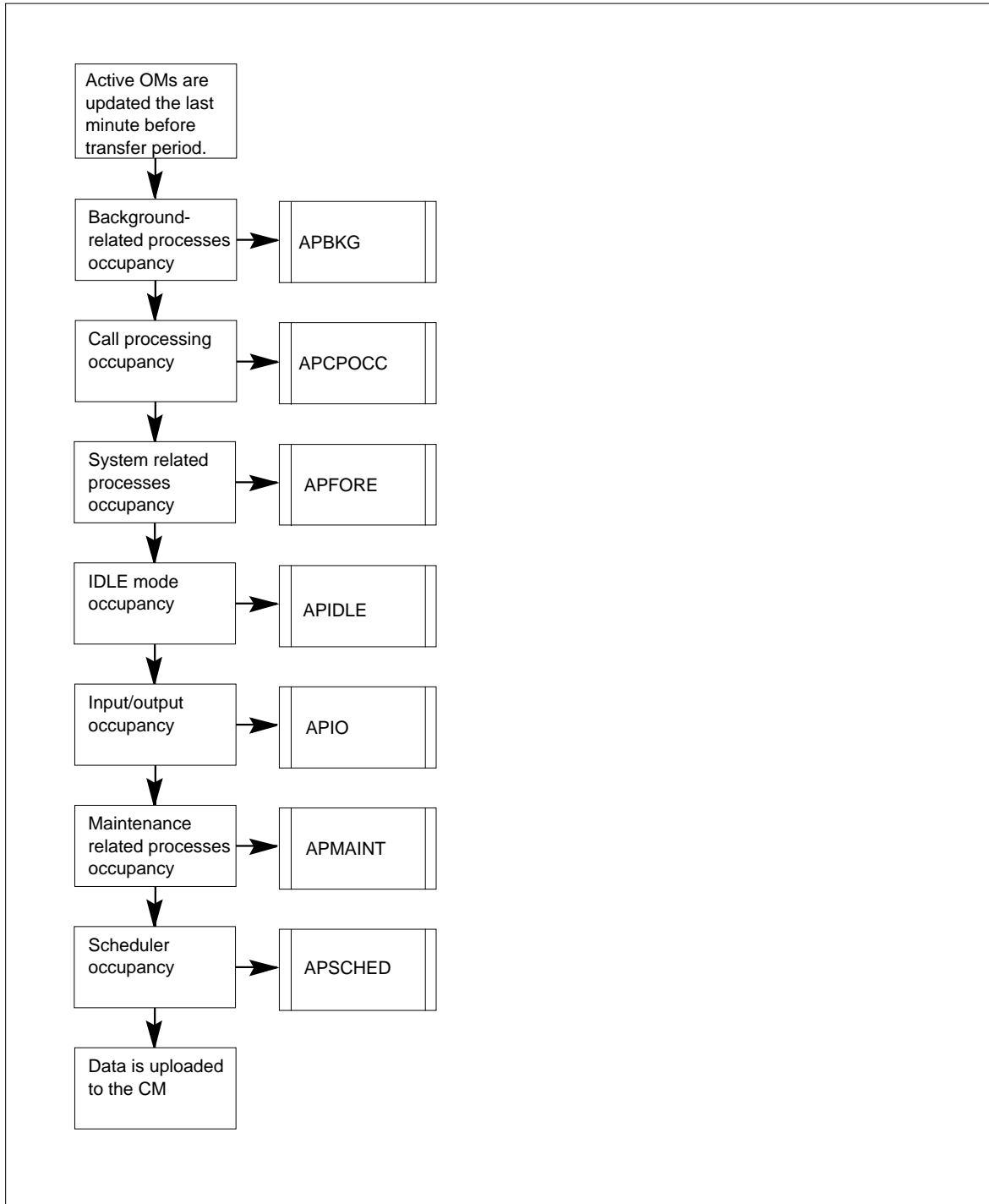
OM group APOCCS (continued)**OM group APOCCS registers**

OM group APOCCS (continued)

Register APBKG

AP node background process occupancy (APBKG)

Register APBKG increases the CPXFR process and measures the background-related processes occupancy.

Register APBKG release history

Register APBKG was introduced in BCS33.

Associated registers

There are no associated registers.

Associated logs

There are no associated logs.

Register APCPOCC

AP node call-processing occupancy (APCPOCC)

The CPXFR process increases register APCPOCC. This register measures call-processing occupancy.

Register APCPOCC release history

Register APCPOCC was introduced in BCS33.

Associated registers

There are no associated registers.

Associated logs

There are no associated logs.

Register APFORE

AP node system-related occupancy (APFORE)

The CPXFR process increases register APFORE. This register measures the system-related processes occupancy.

Register APFORE release history

Register APFORE was introduced in BCS33.

Associated registers

There are no associated registers.

OM group APOCCS (continued)

Associated logs

There are no associated logs.

Register APIDLE

AP node idle occupancy (APIDLE)

The CPXFR process increases register APIDLE. This register measures the time the CPU spends in the IDLE state.

Register APIDLE release history

Register APIDLE was introduced in BCS33.

Associated registers

There are no associated registers.

Associated logs

There are no associated logs.

Register APIO

AP node I/O occupancy (APIO)

The CPXFR process increases register APIO. This register measures the time the CPU spends performing input/output (I/O) functions.

Register APIO release history

Register APIO was introduced in BCS33.

Associated registers

There are no associated registers.

Associated logs

There are no associated logs.

Register APMaint

AP node maintenance occupancy (APMAINT)

The CPXFR process increases register APMaint. This register measures the maintenance-related processes occupancy.

Register APMaint release history

Register APMaint was introduced in BCS33.

OM group APOCCS (end)

Associated registers

There are no associated registers.

Associated logs

There are no associated logs.

Register APSCHED

AP node scheduler occupancy (APSCHED)

The CPXFR process increases register APSCHED. This register measures the scheduler occupancy.

Register APSCHED release history

Register APSCHED was introduced in BCS33.

Associated registers

There are no associated registers.

Associated logs

There are no associated logs.

OM group APSYS

OM description

Application processor node system counts (APSYS)

The OM group APSYS counts basic hardware components of the application processor (AP), including:

- the processor base maintenance
- port maintenance
- as state changes in the duplex operation of the node

The APs are sync-matched nodes, and assume it to operate in synchronous mode. Although the AP remains in use while not in sync, the AP considers the simplex mode of operation an in-service trouble state. The amount of time the node spends in the simplex mode increases in the registers in this group. These registers measure the accuracy of the software that runs on the node and record details from the routine exercise (REX) tests.

Release history

The OM group APSYS was introduced in BCS33.

Registers

The OM group APSYS registers appear on the MAP terminal as follows:

APSSYNC	APSDROP	APSSWACT	APMSWACT
APRSWACT	APTRMISM	APTRAP	APCPUFLT
APMEMFLT	APPRTFLT	APCPUERR	APMEMERR
APPRTERR	APSWERR	APREXFLT	APRCPUFL
APRMEMFL	APRPRTFL	APSSMPXU	APMSMPXU
APRSMPXU			

Group structure

The OM group APSYS provides one tuple for each sync-matched node.

Key field:

SMN_SYMB_NUM

Info field:

There is no info field.

Associated OM groups

There are no associated OM groups.

OM group APSYS (continued)

Associated operating groups

The following operating groups associate with OM group APSYS:

- File Processor
- Line Trunk Server

Associated functionality codes

The associated functionality codes for OM group APSYS appear in the following table.

Functionality	Code
Application Processor Base	NTXF06AA

OM group APSYS (continued)

OM group APSYS registers

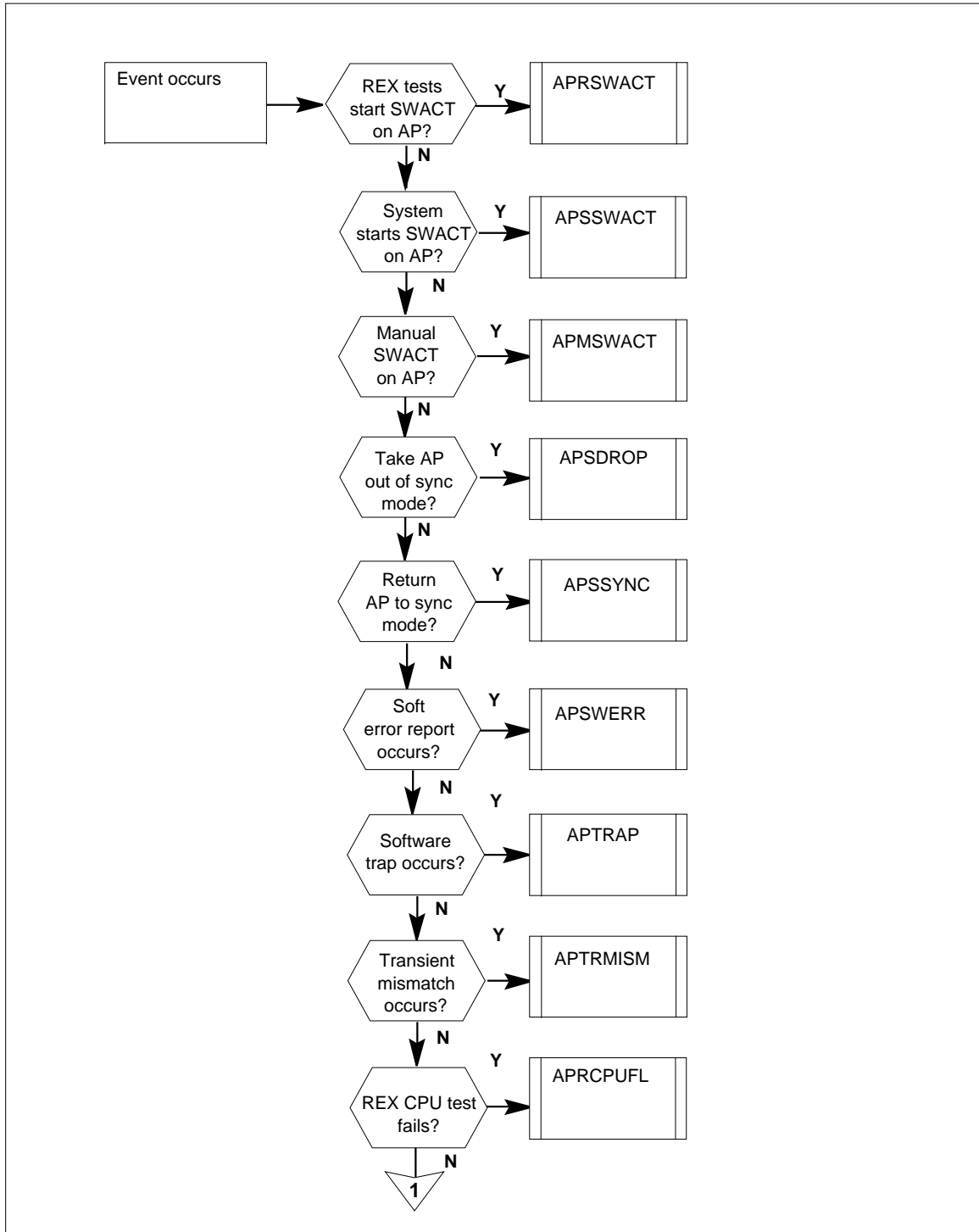

OM group APSYS (continued)

OM group APSYS registers

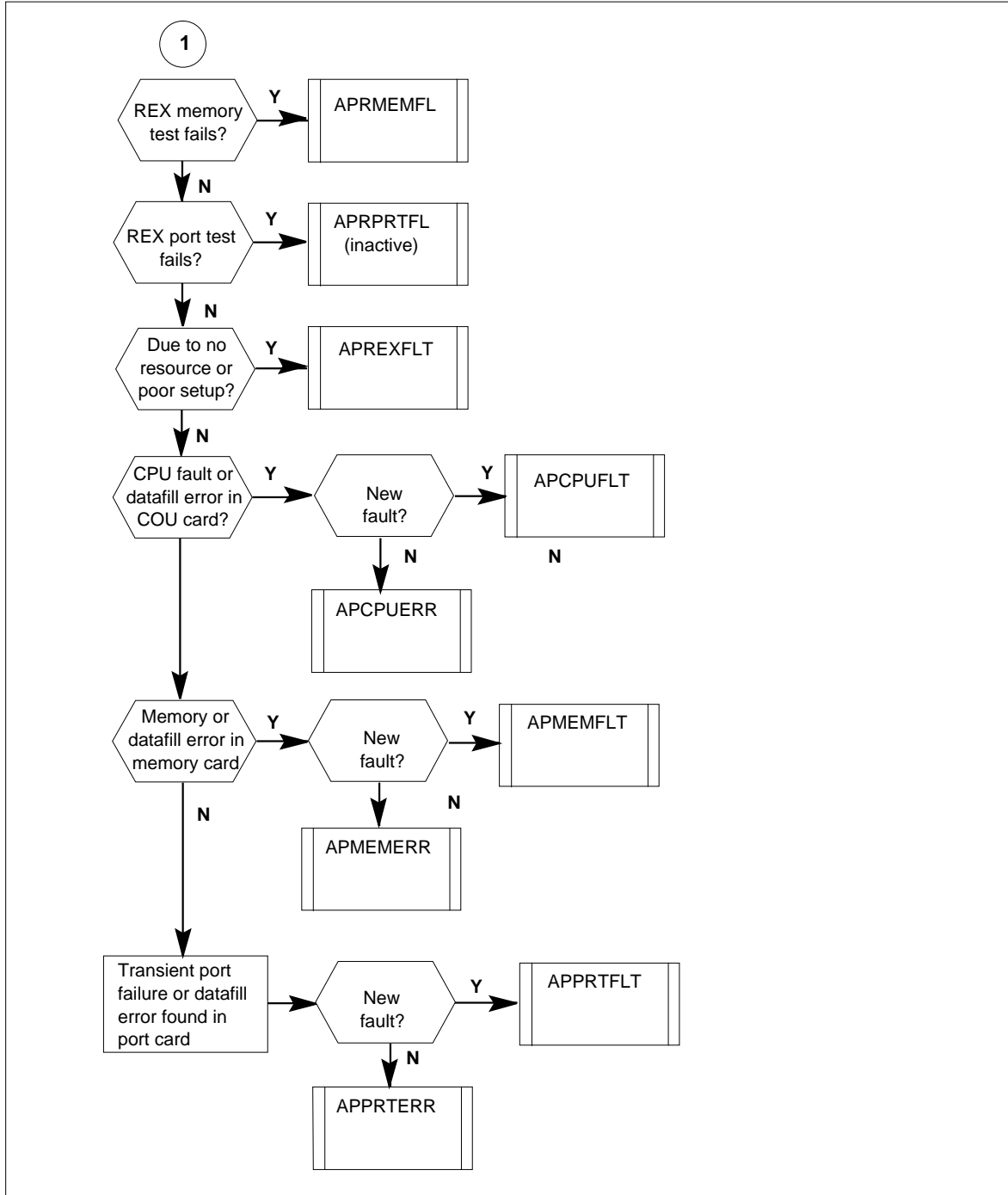

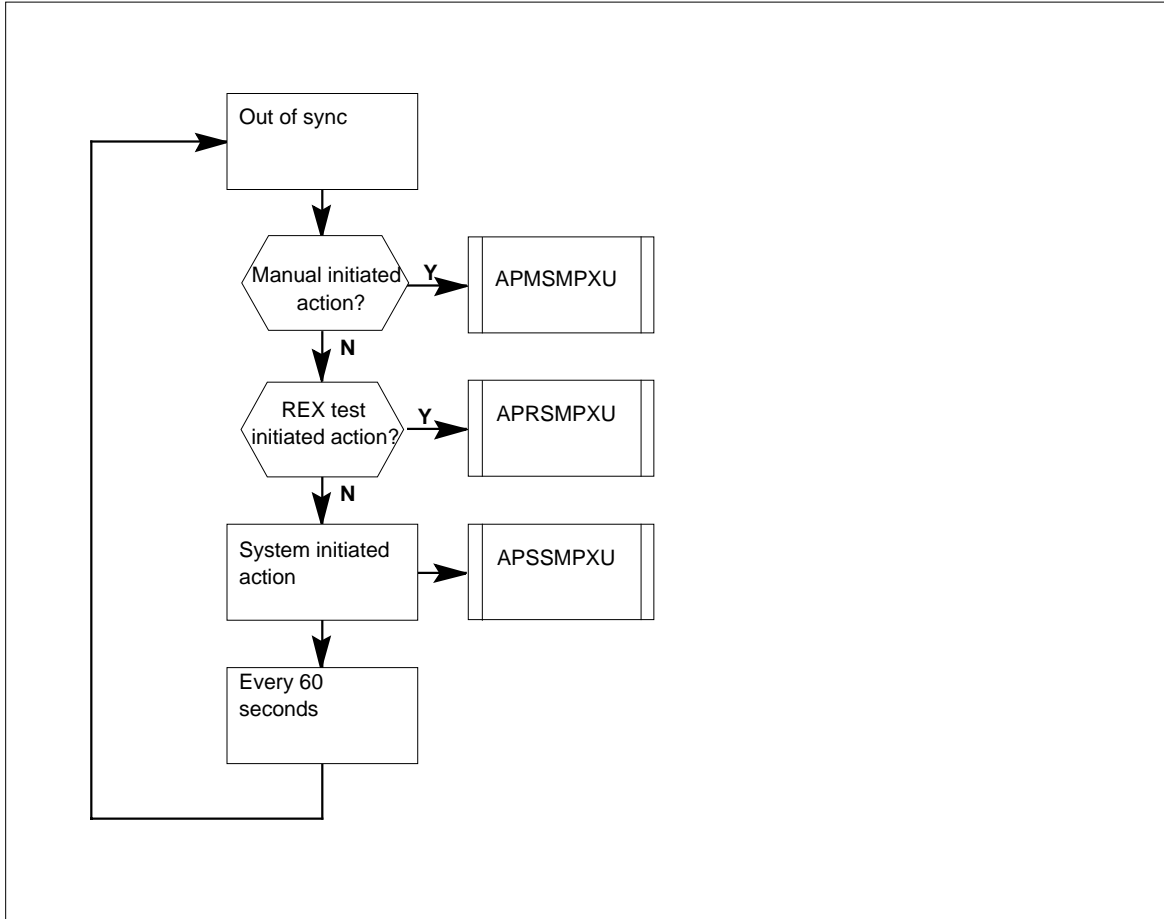
OM group APSYS (continued)**OM group APSYS use registers****Register APCPUERR**

AP node CPU soft error (APCPUERR)

Register APCPUERR increases when the system finds a transient CPU fault or an entry error related to the CPU card.

Register APCPUERR release history

Register APCPUERR was introduced in BCS33.

Associated registers

There are no associated registers.

Associated logs

PM310

OM group APSYS (continued)

PM319

Register APCPUFLT

AP node CPU test fault (APCPUFLT)

Register APCPUFLT increases when a CPU test fails for a new reason.

Register APCPUFLT release history

Register APCPUFLT was introduced in BCS33.

Associated registers

There are no associated registers.

Associated logs

PM310

Register APMEMERR

AP node memory soft error (APMEMERR)

Register APMEMERR increases when the system finds a transient memory fault or an entry error related to a memory card.

Register APMEMERR release history

Register APMEMERR was introduced in BCS33.

Associated registers

There are no associated registers.

Associated logs

PM311

PM319

Register APMEMFLT

AP node memory test fault (APMEMFLT)

Register APMEMFLT increases when a memory test fails for a new reason.

Register APMEMFLT release history

Register APMEMFLT was introduced in BCS33.

Associated registers

There are no associated registers.

OM group APSYS (continued)

Associated logs

PM311

Register APMSMPXU

AP node manual simplex operation (APMSMXPU)

Register APMSMXPU measures the time the AP spends in a simplex mode of operation as a result of a manually initiated action.

Register APMSMPXU release history

Register APMSMPXU was introduced in BCS33.

Associated registers

There are no associated registers.

Associated logs

There are no associated logs.

Register APMSWACT

AP node manual activity change attempt (APMSWACT)

Register APMSWACT increases with every manual attempt to switch processor activity on the AP.

Register APMSWACT release history

Register APMSWACT was introduced in BCS33.

Associated registers

There are no associated registers.

Associated logs

PM501

Register APPRTERR

AP node memory soft error (APPRTERR)

Register APPRTERR increases when the system finds a transient port fault or an entry error related to a port card.

Register APPRTERR release history

Register APPRTERR was introduced in BCS33.

OM group APSYS (continued)

Associated registers

There are no associated registers.

Associated logs

PM312

PM319

Register APPRTFLT

AP node port test fault (APPRTFLT)

Register APPRTFLT increases when a port test fails for a new reason.

Register APPRTFLT release history

Register APPRTFLT was introduced in BCS33.

Associated registers

There are no associated registers.

Associated logs

PM312

Register APRCPUFL

AP node REX CPU class failed (APRCPUFL)

Register APRCPUFL increases when the REX CPU class test fails.

Register APRCPUFL release history

Register APRCPUFL was introduced in BCS33.

Associated registers

There are no associated registers.

Associated logs

PM900

Register APREXFLT

AP node REX test fault (APREXFLT)

Register APREXFLT increases when the system aborts the REX test because of a resource that is not available or because of a lack of proper setup.

OM group APSYS (continued)

Register APREXFLT release history

Register APREXFLT was introduced in BCS33.

Associated registers

There are no associated registers.

Associated logs

IEM900

Register APRMEMFL

AP node REX memory class failed (APRMEMFL)

Register APRMEMFL increases when the REX memory class test fails.

Register APRMEMFL release history

Register APRMEMFL was introduced in BCS33.

Associated registers

There are no associated registers.

Associated logs

IEM900

Register APRPRTFL

AP node REX port class failed (APRPRTFL)

Register APRPRTFL increases when the REX port class test fails.

This register is not activated.

Register APRPRTFL release history

Register APRPRTFL was introduced in BCS33.

Associated registers

There are no associated registers.

Associated logs

IEM900

Register APRSMPXU

AP node REX test simplex operation (APRSMPXU)

OM group APSYS (continued)

Register APRSMPXU measures the amount of time the AP spends in a simplex mode of operation as a result of an action initiated by a REX test.

Register APRSMPXU release history

Register APRSMPXU was introduced in BCS33.

Associated registers

There are no associated registers.

Associated logs

There are no associated logs.

Register APRSWACT

AP node REX test activity change attempt (APRSWACT)

Register APRSWACT increases when the REX test attempts to test switch processor activity on the AP.

Register APRSWACT release history

Register APRSWACT was introduced in BCS33.

Associated registers

There are no associated registers.

Associated logs

PM501

Register APSDROP

AP node system drop-of-sync attempt (APSDROP)

Register APSDROP increases when the system attempts to take the AP out of its synchronous mode of operation.

Register APSDROP release history

Register APSDROP was introduced in BCS33.

Associated registers

There are no associated registers.

OM group APSYS (continued)

Associated logs

These logs associate with register APSDROP:

- PM317
- PM318
- PM503

Register APSSMPXU

AP node manual simplex operation (APSSMPXU)

Register APSSMPXU measures the amount of time the AP spends in simplex mode of operation as a result of a system-initiated action.

Register APSSMPXU release history

Register APSSMPXU was introduced in BCS33.

Associated registers

There are no associated registers.

Associated logs

There are no associated logs.

Register APSSWACT

AP node system activity change attempt (APSSWACT)

Register APSSWACT increases when the system attempts to switch processor activity on the AP.

Register APSSWACT release history

Register APSSWACT was introduced in BCS33.

Associated registers

There are no associated registers.

Associated logs

There are no associated registers.

Register APSSYNC

AP node system sync attempt (APSSYNC)

Register APSSYNC increases when the system attempts to put the AP in synchronous mode of operation.

OM group APSYS (continued)

Register APSSYNC release history

Register APSSYNC was introduced in BCS33.

Associated registers

There are no associated registers.

Associated logs

PM503

Register APSWERR

AP node soft error (APSWERR)

Register APSWERR increases when a soft error report occurs.

Register APSWERR release history

Register APSWERR was introduced in BCS33.

Associated registers

There are no associated registers.

Associated logs

There are no associated logs.

Register APTRAP

AP node trap (APTRAP)

Register APTRAP increases when a software trap occurs.

Register APTRAP release history

Register APTRAP was introduced in BCS33.

Associated registers

There are no associated registers.

Associated logs

PM320

Register APTRMISM

AP node transient mismatch (APTRMISM)

Register APTRMISM increases when a transient mismatch occurs.

OM group APSYS (end)

Register APTRMISM release history

Register APTRMISM was introduced in BCS33.

Associated registers

There are no associated registers.

Associated logs

The following logs associate with register APTRMISM:

- PM317
- PM318
- PM503

OM group ASUFBUS

OM description

Application-specific unit (ASU) frame transport bus (F-bus)(ASUFBUS)

The OM group ASUFBUS monitors transmit and receive activity between the F-buses and the ASU.

The OM group ASUFBUS contains 32 registers that count

- packets transmitted by an ASU on each F-bus
- packets received by an ASU on each F-bus
- transmit errors by an ASU on each F-bus
- receive errors by an ASU on each F-bus
- octets transmitted by an ASU on each F-bus
- octets received by an ASU on each F-bus
- times congestion turned on by an ASU for each F-bus
- high priority messages transmitted by an ASU on each F-bus
- messages that require enqueueing by an ASU on each F-bus

Release history

TL03

The OM group ASUFBUS was introduced in CSP03.

TL07

Ethernet link interface unit (ELIU) was added as a valid entry in the NCMNODE_INFO OM key.

TL11

Updated for high-speed links.

Registers

The following OM group ASUFBUS registers appear on the MAP terminal:

OM group ASUFBUS (continued)

FB0TXPK2	FB0TXPKT	FB0RXP2	FB0RXPKT
FB1TXPK2	FB1TXPKT	FB1RXP2	FB1RXPKT
FB0TXER2	FB0TXERR	FB0RXER2	FB0RXERR
FB1TXER2	FB1TXERR	FB1RXER2	FB1RXERR
FB0TXOC2	FB0TXOCT	FB0RXOC2	FB0RXOCT
FB1TXOC2	FB1TXOCT	FB1RXOC2	FB1RXOCT
FB0TXCON	FB0TXPRI	FB0TXEN2	FB0TXENQ
FB1TXCON	FB1TXPRI	FB1TXEN2	FB1TXENQ

Group structure

The OM group ASUFBUS

Key field:

There is no Key field

Info field:

pm_type is LIU7, HLIU, HSLR, SVR7, EIU, ELIU, FRIU, XLIU, APU,
or VPU pm_number is an integer (0 to 999)

Associated OM groups

There are no associated OM groups.

Associated functional groups

The SuperNode DMS switch associates with OM group ASUFBUS:

Associated functionality codes

The associated functionality codes for OM group ASUFBUS appear in the following table.

Functionality	Code
CM Common	NTX941AA
MS Common	NTX951AA

OM group ASUFBUS (continued)

OM group ASUFBUS transmit registers on F-bus 0

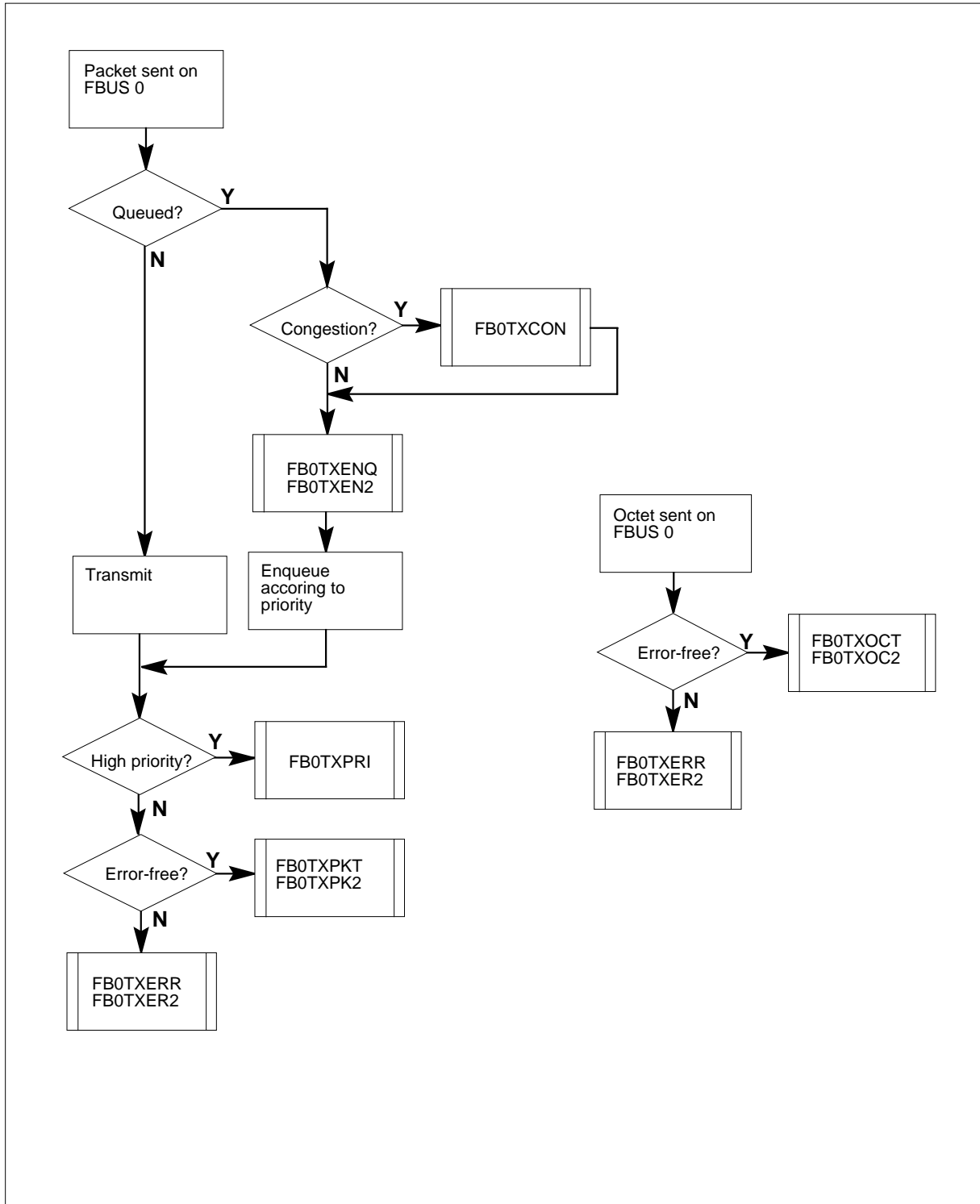

OM group ASUFBUS (continued)

OM group ASUFBUS transmit registers on F-bus 1

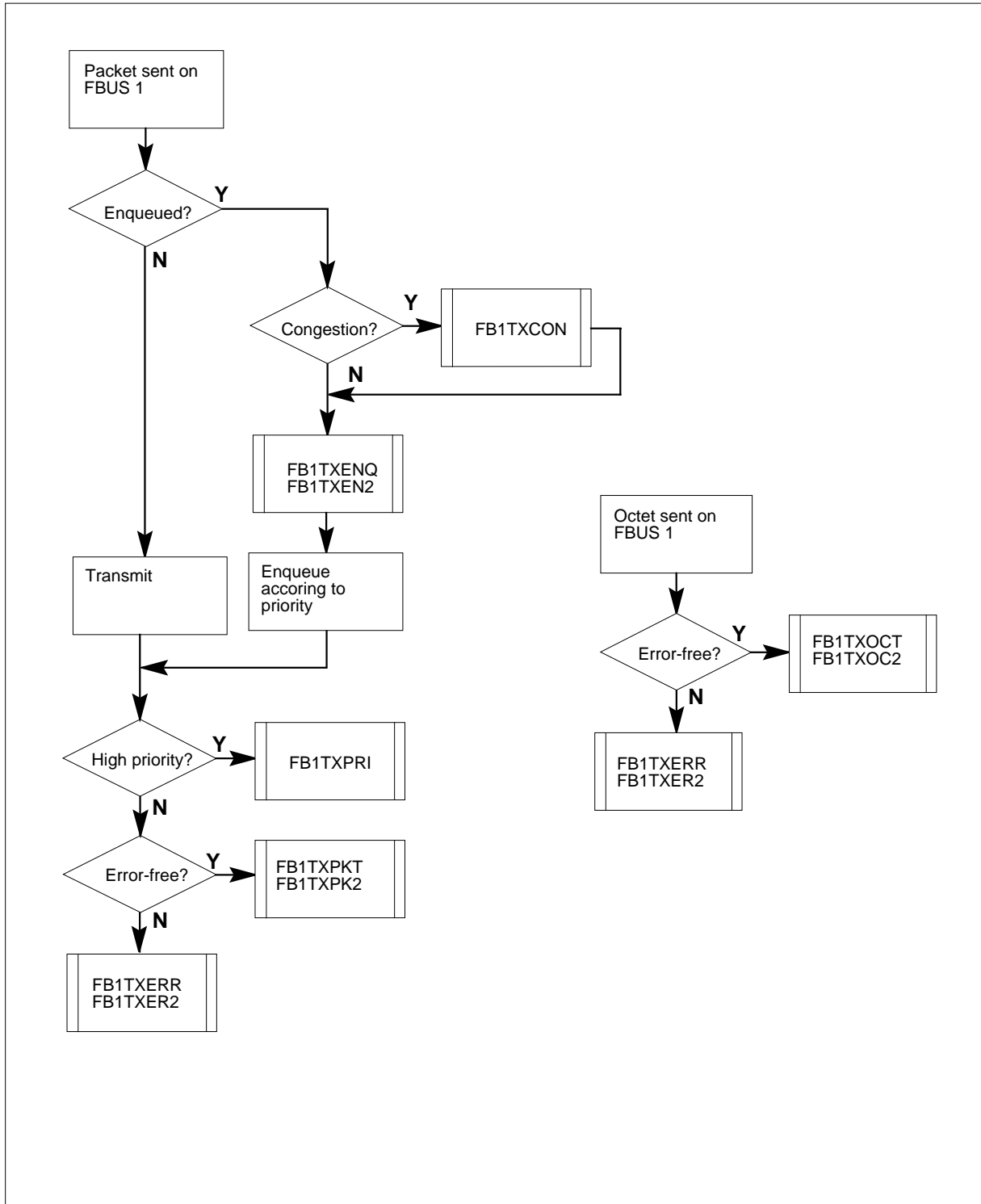

OM group ASUFBUS (continued)

OM group ASUFBUS receive registers

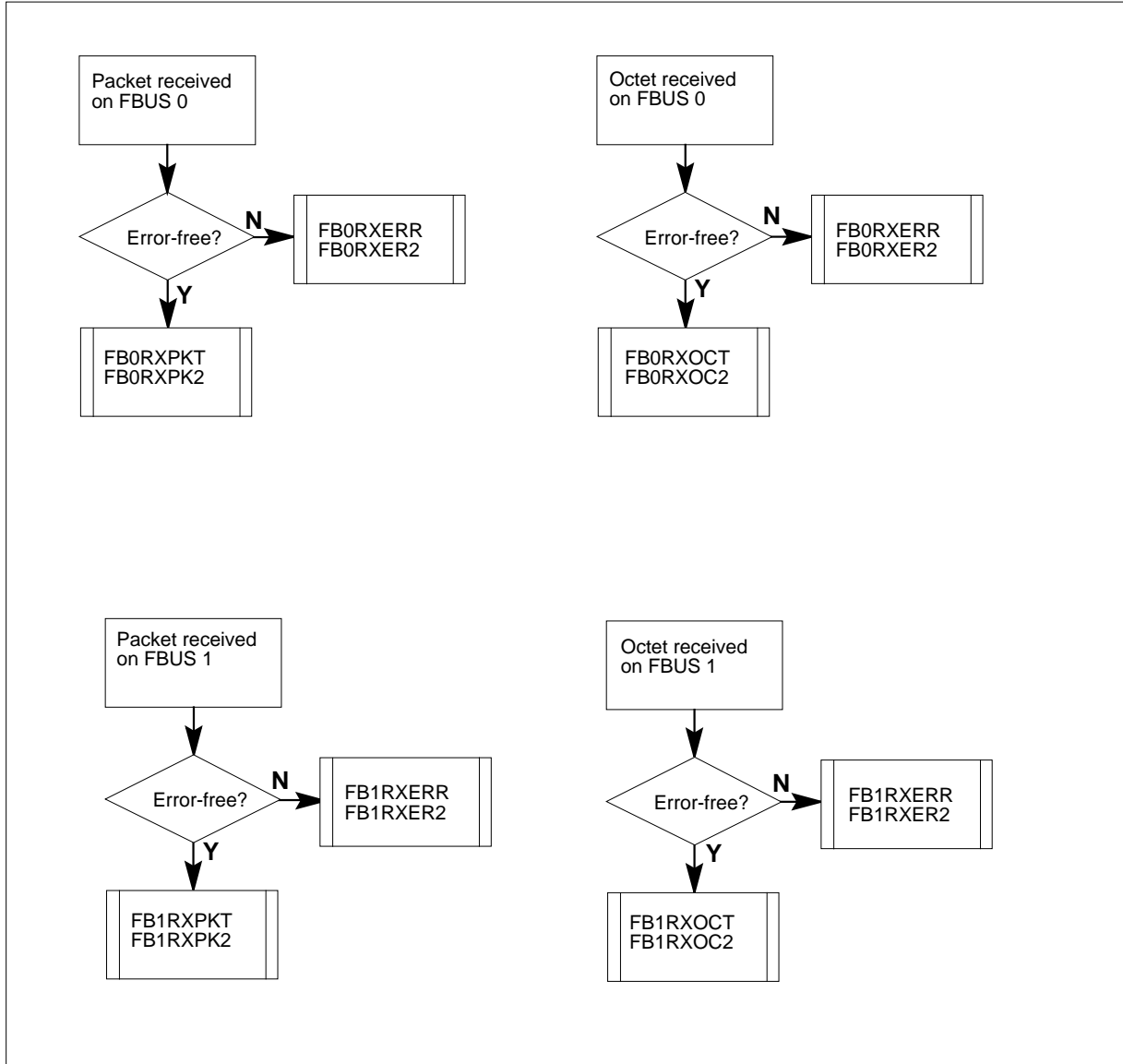

Register FB0RXERR

F-bus 0 receive errors (FB0RXERR)

Register FB0RXERR counts the packets that the ASU was not able to receive from F-bus 0 due to an error.

Register FB0RXERR release history

Register FB0RXERR was introduced in CSP03.

OM group ASUFBUS (continued)

Associated registers

The extension register is FB0RXER2.

Associated logs

There are no associated logs.

Extension registers

FB0RXER2

Register FB0RXOCT

F-bus 0 receive octets (FB0RXOCT)

Register FB0RXOCT counts the octets (bytes) that the ASU receives from F-bus 0.

Register FB0RXOCT release history

Register FB0RXOCT was introduced in CSP03.

Associated registers

The extension register is FB0RXOC2.

Associated logs

There are no associated logs.

Extension registers

FB0RXOC2

Register FB0RXPKT

F-bus 0 receive packets (FB0RXPKT)

Register FB0RXPKT counts the packets that the ASU receives from F-bus 0.

Register FB0RXPKT release history

Register FB0RXPKT was introduced in CSP03.

Associated registers

The extension register is FB0RXP2.

Associated logs

There are no associated logs.

Extension registers

FB0RXP2

OM group ASUFBUS (continued)

Register FB0TXCON

F-bus 0 transmit congestion (FB0TXCON)

Register FB0TXCON counts the times the system turns on congestion for F-bus 0.

Register FB0TXCON release history

Register FB0TXCON was introduced in CSP06.

Associated registers

The congestion register for F-bus 1 is FB1TXCON.

Associated logs

There are no associated logs.

Extension registers

There are no extension registers.

Register FB0TXENQ

F-bus 0 transmit enqueueing (FB0TXENQ)

Register FB0TXENQ counts the messages on F-bus 0 that require enqueueing.

Register FB0TXENQ release history

Register FB0TXENQ was introduced in CSP06.

Associated registers

The queueing register for F-bus 1 is FB1TXENQ.

The extension register is FB0TXEN2.

Associated logs

There are no associated logs.

Extension registers

FB0TXEN2

Register FB0TXERR

F-bus 0 transmit errors (FB0TXERR)

Register FB0TXERR counts the packets that the ASU was not able to transmit to F-bus 0 due to an error.

OM group ASUFBUS (continued)

Register FB0TXERR release history

Register FB0TXERR was introduced in CSP03.

Associated registers

The extension register is FB0TXER2.

Associated logs

There are no associated logs.

Extension registers

FB0TXER2

Register FB0TXOCT

F-bus 0 transmit octets (FB0TXOCT)

Register FB0TXOCT counts the octets (bytes) that the ASU transmits to F-bus 0.

Register FB0TXOCT release history

Register FB0TXOCT was introduced in CSP03.

Associated registers

The extension register is FB0TXOC2.

Associated logs

There are no associated logs.

Extension registers

FB0TXOC2

Register FB0TXPKT

F-bus 0 transmit packets (FB0TXPKT)

Register FB0TXPKT counts the packets that the ASU transmits to F-bus 0.

Register FB0TXPKT release history

Register FB0TXPKT was introduced in CSP03.

Associated registers

The extension register is FB0TXPK2.

Associated logs

There are no associated logs.

OM group ASUFBUS (continued)

Extension registers

FB0TXPK2

Register FB0TXPRI

F-bus 0 transmit priority (FB0TXPRI)

Register FB0TXPRI counts the high priority messages that the ASU transmits on F-bus 0.

Register FB0TXPRI release history

Register FB0TXPRI was introduced in CSP06.

Associated registers

The high priority register for F-bus 1 is FB1TXPRI.

Associated logs

There are no associated logs.

Extension registers

There are no extension registers.

Register FB1RXERR

F-bus 1 receive errors (FB1RXERR)

Register FB1RXERR counts the packets that the ASU was not able to receive from F-bus 1 due to an error.

Register FB1RXERR release history

Register FB1RXERR was introduced in CSP03.

Associated registers

The extension register is FB1RXER2.

Associated logs

There are no associated logs.

Extension registers

FB1RXER2

Register FB1RXOCT

F-bus 1 receive octets (FB1RXOCT)

OM group ASUFBUS (continued)

Register FB1RXOCT counts the octets (bytes) that the ASU received from F-bus 1.

Register FB1RXOCT release history

Register FB1RXOCT was introduced in CSP03.

Associated registers

The extension register is FB1RXOC2.

Associated logs

There are no associated logs.

Extension registers

FB1RXOC2

Register FB1RXPKT

F-bus 1 receive packets (FB1RXPKT)

Register FB1RXPKT counts the packets that the ASU received from F-bus 1.

Register FB1RXPKT release history

Register FB1RXPKT was introduced in CSP03.

Associated registers

The extension register is FB1RXP2.

Associated logs

There are no associated logs.

Extension registers

FB1RXP2

Register FB1TXCON

F-bus 1 transmit congestion (FB1TXCON)

Register FB1TXCON counts the times the system turns on congestion for F-bus 1.

Register FB1TXCON release history

Register FB1TXCON was introduced in CSP06.

Associated registers

The congestion register for F-bus 0 is FB0TXCON.

OM group ASUFBUS (continued)

Associated logs

There are no associated logs.

Extension registers

There are no extension registers.

Register FB1TXENQ

F-bus 1 transmit enqueueing (FB1TXENQ)

Register FB1TXENQ counts the messages on F-bus 1 that require enqueueing.

Register FB1TXENQ release history

Register FB1TXENQ was introduced in CSP06.

Associated registers

The queueing register for F-bus 0 is FB0TXENQ.

The extension register is FB1TXEN2.

Associated logs

There are no associated logs.

Extension registers

FB1TXEN2

Register FB1TXERR

F-bus 1 transmit errors (FB1TXERR)

Register FB1TXERR counts the packets that the ASU was not able to transmit to F-bus 1 due to an error.

Register FB1TXERR release history

Register FB1TXERR was introduced in CSP03.

Associated registers

The extension register is FB1TXER2.

Associated logs

There are no associated logs.

Extension registers

FB1TXER2

OM group ASUFBUS (continued)

Register FB1TXOCT

F-bus 1 transmit octets (FB1TXOCT)

Register FB1TXOCT counts the octets (bytes) that the ASU transmits from the ASU to F-bus 1.

Register FB1TXOCT release history

Register FB1TXOCT was introduced in CSP03.

Associated registers

The extension register is FB1TXOC2.

Associated logs

There are no associated logs.

Extension registers

FB1TXOC2

Register FB1TXPKT

F-bus 1 transmit packets (FB1TXPKT)

Register FB1TXPKT counts the packets that the ASU transmits to F-bus 1.

Register FB1TXPKT release history

Register FB1TXPKT was introduced in CSP03.

Associated registers

The extension register is FB1TXPK2.

Associated logs

There are no associated logs.

Extension registers

FB1TXPK2

Register FB1TXPRI

F-bus 1 transmit priority (FB1TXPRI)

Register FB1TXPRI counts the high priority messages that the ASU transmits on F-bus 1.

Register FB1TXPRI release history

Register FB1TXPRI was introduced in CSP06.

OM group ASUFBUS (end)

Associated registers

The high priority register for F-bus 0 is FB0TXPRI.

Associated logs

There are no associated logs.

Extension registers

There are no extension registers.

OM group ASUMEMUT

OM description

Application specific unit (ASU) memory utilization (ASUMEMUT)

Operational measurement (OM) group ASUMEMUT monitors the use of data store and program store for an ASU.

The ASUMEMUT contains four registers that count:

- total Data Store memory
- free Data Store memory
- total Program Store memory
- free Program Store memory

Note: OM group ASUMEMUT deals with static data (memory use) and must not increase by way of table OMACC. Any accumulation class on this OM group returns invalid values.

Release history

The OM group ASUMEMUT was introduced in CSP03.

TL11

Updated for high-speed links.

Registers

The following OM group ASUMEMUT registers appear on the MAP terminal:

ASUDSTOT	ASUDSAVL	ASUPSTOT	ASUPSAVL
----------	----------	----------	----------

Group structure

The OM group ASUMEMUT

Key field:

There is no Key field.

Info field:

pm_type is LIU7, HLIU, HSLR, SVR7, EIU, XLIU, APU, or VPU
 pm_number is an integer (1-999)

OM group ASUMEMUT (continued)

Associated OM groups

There are no associated OM groups.

Associated functional groups

Functional group SuperNode DMS switch associates with OM group ASUMEMUT:

Associated functionality codes

The associated functionality codes for OM group ASUMEMUT appear in the following table.

Functionality	Code
CM Common	NTX941AA
MS Common	NTX951AA

OM group ASUMEMUT registers

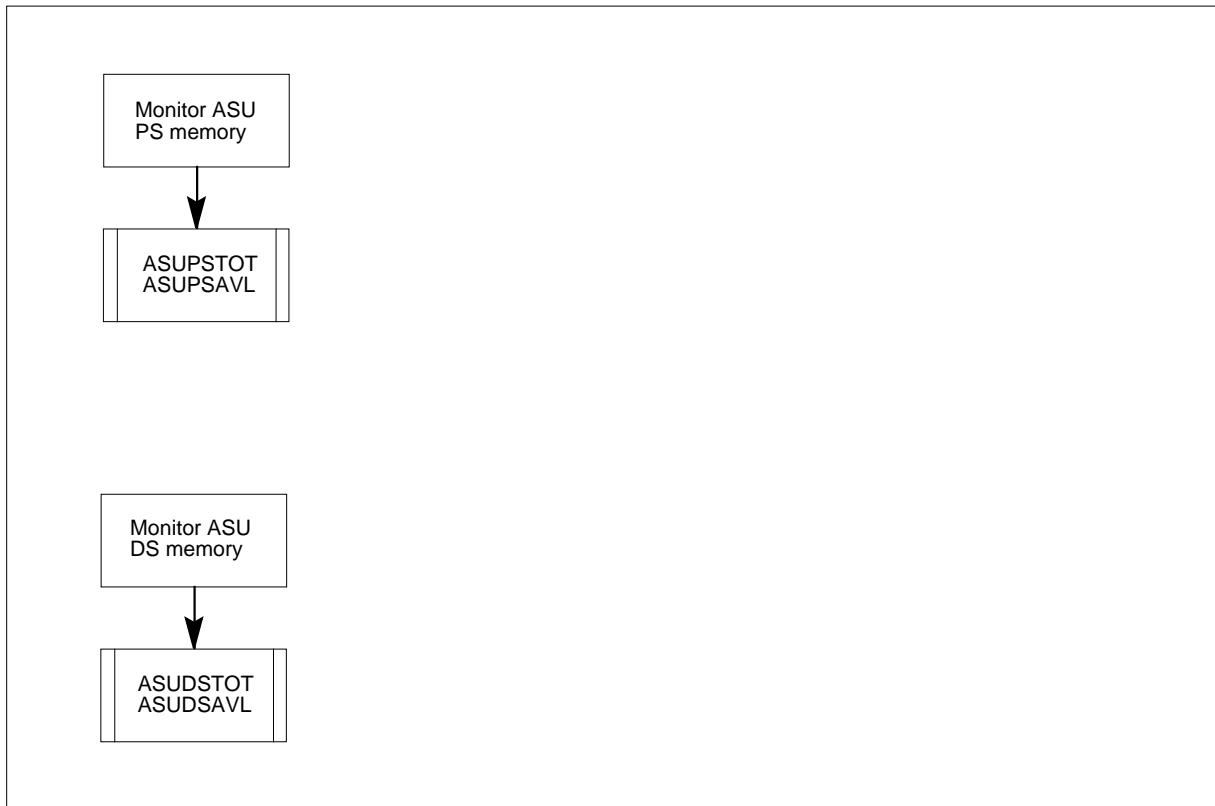

OM group ASUMEMUT (continued)

Register ASUDSTOT

Total Data Store memory (ASUDSTOT)

Register ASUDSTOT contains the number of Kbytes of DS memory.

Register ASUDSTOT release history

Register ASUDSTOT was introduced in CSP03.

Associated registers

There are no associated registers.

Associated logs

There are no associated logs.

Register ASUDSAVL

Free Data Store memory (ASUDSAVL)

Register ASUDSAVL contains the number of Kbytes of DS memory available for use.

Register ASUDSAVL release history

Register ASUDSAVL was introduced in CSP03.

Associated registers

There are no associated registers.

Associated logs

There are no associated logs.

Register ASUPSTOT

Total Program Store memory (ASUPSTOT)

Register ASUPSTOT contains the number of Kbytes of PS memory.

Register ASUPSTOT release history

Register ASUPSTOT was introduced in CSP03.

Associated registers

There are no associated registers.

Associated logs

There are no associated logs.

OM group ASUMEMUT (end)

Register ASUPSAVL

Free Program Store memory (ASUPSAVL)

Register ASUPSAVL contains the number of Kbytes of PS memory available for use.

Register ASUPSAVL release history

Register ASUPSAVL was introduced in CSP03.

Associated registers

There are no associated registers.

Associated logs

There are no associated logs.

OM group BCTPOOL

OM description

Bearer Channel Tandeming Resource Pool

The following peg registers count:

- errors and faults in the IOCs
- device errors the that system detects on P-side links

The following usage registers record:

- system busy links
- manual busy links
- system busy links
- manual busy links

The data that the IOC supplies is used to monitor the performance of the IOCs and the output devices that the IOCs support.

Release history

OM group BCTPOOL was introduced in a previous release, but not documented until SN06 (DMS).

Registers

OM group BCTPOOL registers display on the MAP terminal as follows:

BCTRSRVA	BCTRSRVS	BCTRQSTA	BCTRQSTS
----------	----------	----------	----------

Group structure

OM group BCTPOOL provides one tuple per BCT Resource Pool.

Key field:

XPM_NO, the XPM_NO (0 - 255) of the BCT Resource Pool, used with the BCT PM_TYPE as a key into table SERVSINV.

OM group BCTPOOL (continued)

Info field:

None

Associated OM groups

The OM group BCTTANDM displays information on the attempts and successes of tandeming calls.

Associated functional groups

None

Associated functionality codes

OM group BCTPOOL registers

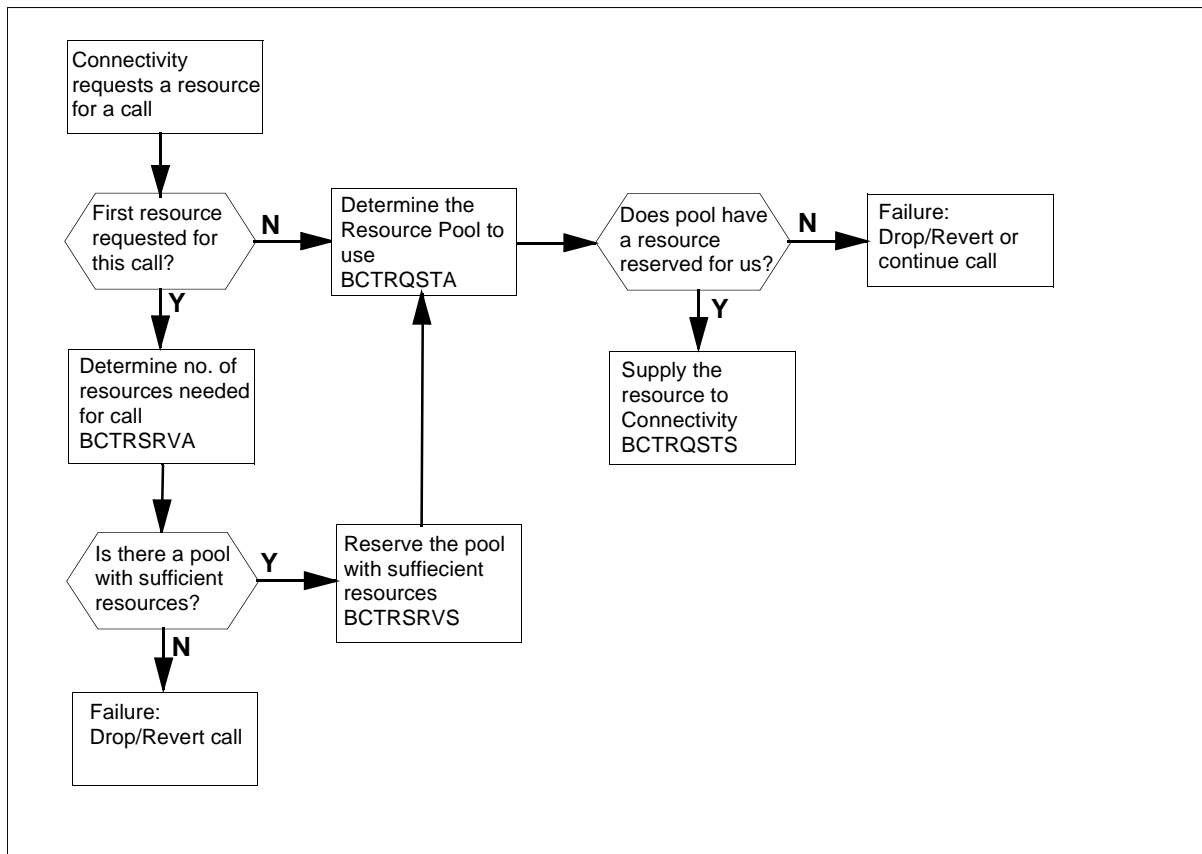

Register BCTRSRVA

BCT Pool Reservation Attempts

OM group BCTPOOL (continued)

BCTRSRVA is a peg register which counts the number of attempts made to reserve resources from a BCT Resource Pool.

Register BCTRSRVA release history

BCTRSRVA was introduced in SN03.

Associated registers

BCTRSRVS: Indicates the number of successful reservations of BCT resources from the pool.

Associated logs

None

Register BCTRSRVS

BCT Pool Reservation Successes

BCTRSRVS is a peg register which counts the number of times that resources were successfully reserved from a BCT Resource Pool.

Register BCTRSRVS release history

BCTRSRVS was introduced in SN03.

Associated registers

BCTRSRVA: Indicates the number of attempts made to reserve resources from a BCT Resource Pool.

Associated logs

None

Register BCTRQSTA

BCT Resource Pool Resource Request Attempts

BCTRQSTA is a peg register which counts the number of attempts made to request a resource from a BCT Resource Pool.

Register BCTRQSTA release history

BCTRQSTA was introduced in SN03.

Associated registers

BCTRQSTS: Indicates the number of times a resource was successfully requested from a BCT Resource Pool.

OM group BCTPOOL (end)

Associated logs

None

Register BCTRQSTS

BCT Resource Pool Resource Request Successes

BCTRQSTS is a peg register which counts the number of times a resource was successfully requested from a Resource Pool.

Register BCTRQSTS release history

BCTRQSTS was introduced in SN03.

Associated registers

BCTRQSTA: Indicates the number of times a resource was requested from a BCT Resource Pool.

Associated logs

None

OM group BCTTANDM

OM description

Bearer Channel Tandeming Tandemed Calls

Release history

OM group BCTTANDM was introduced in a previous release, but not documented until SN06 (DMS).

Registers

OM group BCTTANDM registers display on the MAP terminal as follows:

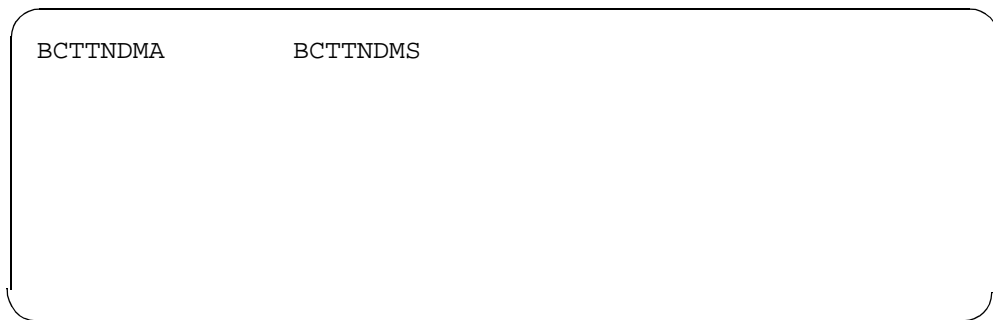

BCTTNDMA	BCTTNDMS
----------	----------

Group structure

OM group BCTTANDM provides one tuple.

Key field:

None

Info field:

None

Associated OM groups

BCTPOOL keeps track of the number of times resources were reserved/requested on a per pool basis.

Associated functional groups

None

Associated functionality codes

OM group BCTTANDM (continued)

OM group BCTTANDM registers

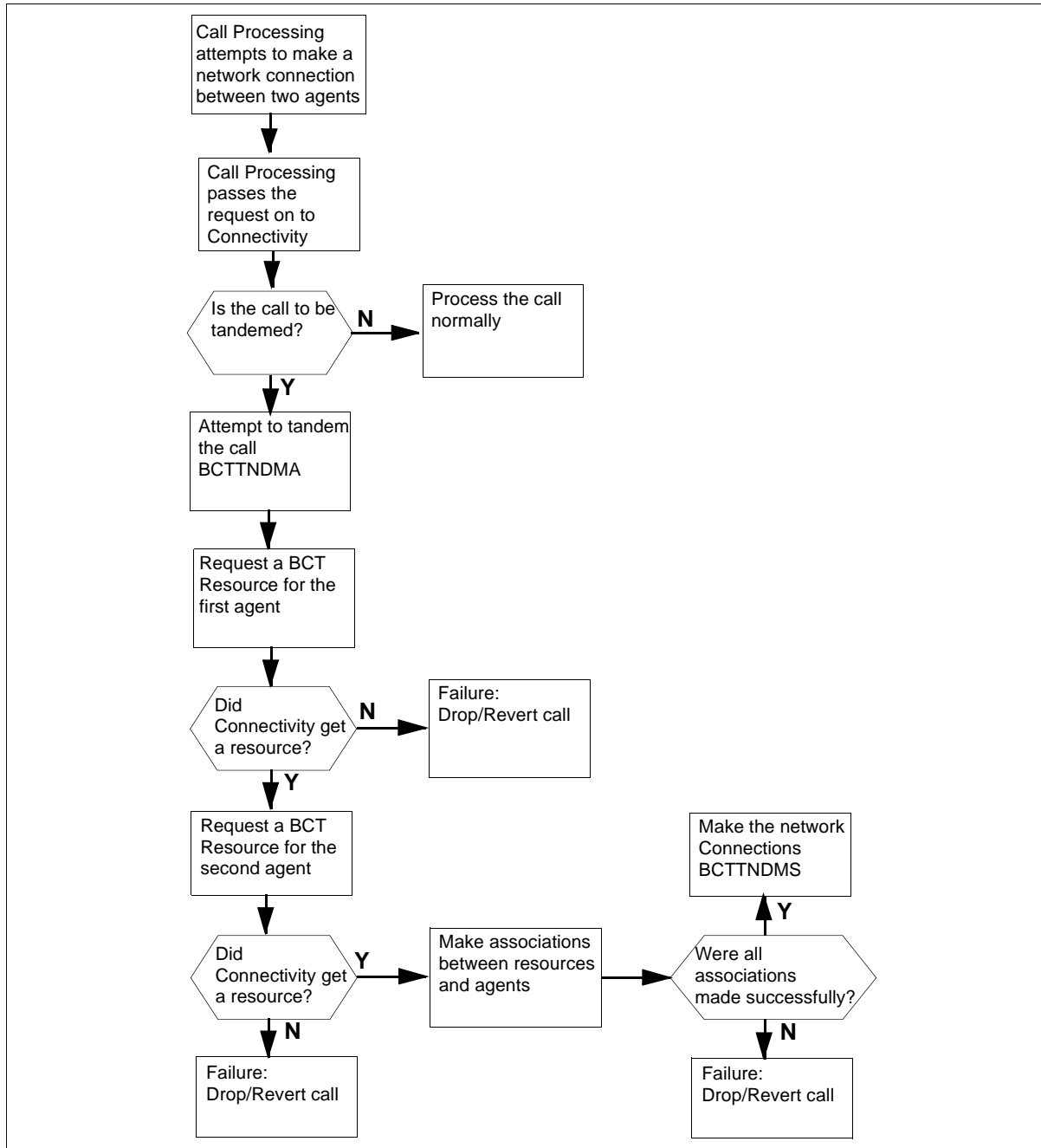

Register BCTTNDMA

BCT Tandeming Attempts

OM group BCTTANDM (end)

BCTTNDMA is a peg register which counts the number of calls that are attempted to be tandemed.

Register BCTTNDMA release history

BCTTNDMA was introduced in SN03.

Associated registers

BCTTNDMS: Indicates the number of calls that are successfully tandemed.

Associated logs

None

Register BCTTNDMS

BCT Tandeming Successes

BCTTNDMS is a peg register which counts the number of calls that are successfully tandemed.

Register BCTTNDMS release history

BCTTNDMS was introduced in SN03.

Associated registers

BCTTNDMA: Indicates the number of calls that were attempted to be tandemed.

Associated logs

None

OM group BLUEBSTR

OM description

Blue Box Fraud Using Specialized Tone Receiver

The BLUEBSTR operational measurement (OM) group provides a quick summary of blue box fraud traffic detected by the specialized tone receiver.

Release history

OM group BLUEBSTR was introduced in BCS26.

Registers

OM group BLUEBSTR registers display as follows:

SFATTEMP	BBFDETEC	BBFRTRMT	BBFNOSTR
----------	----------	----------	----------

Group structure

OM group BLUEBSTR provides one tuple per office.

Key field:

COMMON_LANGUAGE_NAME

Info field:

NIL_TYPE_ID

Associated OM groups

None

Associated products

None

Register SFATTEMP

Single Frequency Detected

Each occurrence of single frequency detection by the specialized tone receiver causes the SFATTEMP peg to increment for the given trunk group.

Register SFATTEMP release history

SFATTEMP was introduced in BCS26.

OM group BLUEBSTR (end)

Register BBFDETEC

Blue Box Fraud Detect

BBFDETEC is the number of occurrences of blue box fraud detected by the specialized tone receiver.

Register BBFDETEC release history

BBFDETEC was introduced in BCS26.

Associated logs

TRK350

Register BBFTRMT

Blue Box Fraud Treatment

BBFTRMT is the total number of blue box fraud calls routed to treatment.

Register BBFTRMT release history

BBFTRMT was introduced in BCS26.

Register BBFNOSTR

Blue Box Fraud Not Specialized Tone Receiver

BBFNOSTR is the number of calls not scanned for blue box fraud because the originating digital trunk controller was not equipped with specialized tone receiver.

Register BBFNOSTR release history

BBFNOSTR was introduced in BCS26.

OM group C7GTLNK

OM description

SCCP global title OMs per link

The operational measurement (OM) group C7GTLNK captures operational information about global title translations (GTT) OMs uploaded from the link. When the GTT OMs are uploaded, C7GTLNK places each OM in its own register corresponding to the correct link.

OM group C7GTLNK consists of seven registers. These registers monitor the following:

- number of GTTs performed
- number of failed GTTs that encountered errors in the called party address (CDPA)
- number of hop counter problems
- number of message signal units (MSU) sampled that experience handling delays more than 95% of the time with and without GTT

Release history

OM group C7GTLNK was introduced in TL10.

Registers

The following OM group C7GTLNK registers display on the MAP terminal as follows:

C7GTT	C7GTT2	C7RFNTN	C7RFNTA
C7HOPERR	C795GTT	C795NGTT	

Group structure

Key field:

C7_LINKSET_NUMBER {0 TO max_c7_linksets +1}

Info field:

C7LINK_OMINFO {0 to 15}

Associated OM groups

C7SCCP

OM group C7GTLNK (continued)

Associated functional groups

None

Associated functionality codes

N/A

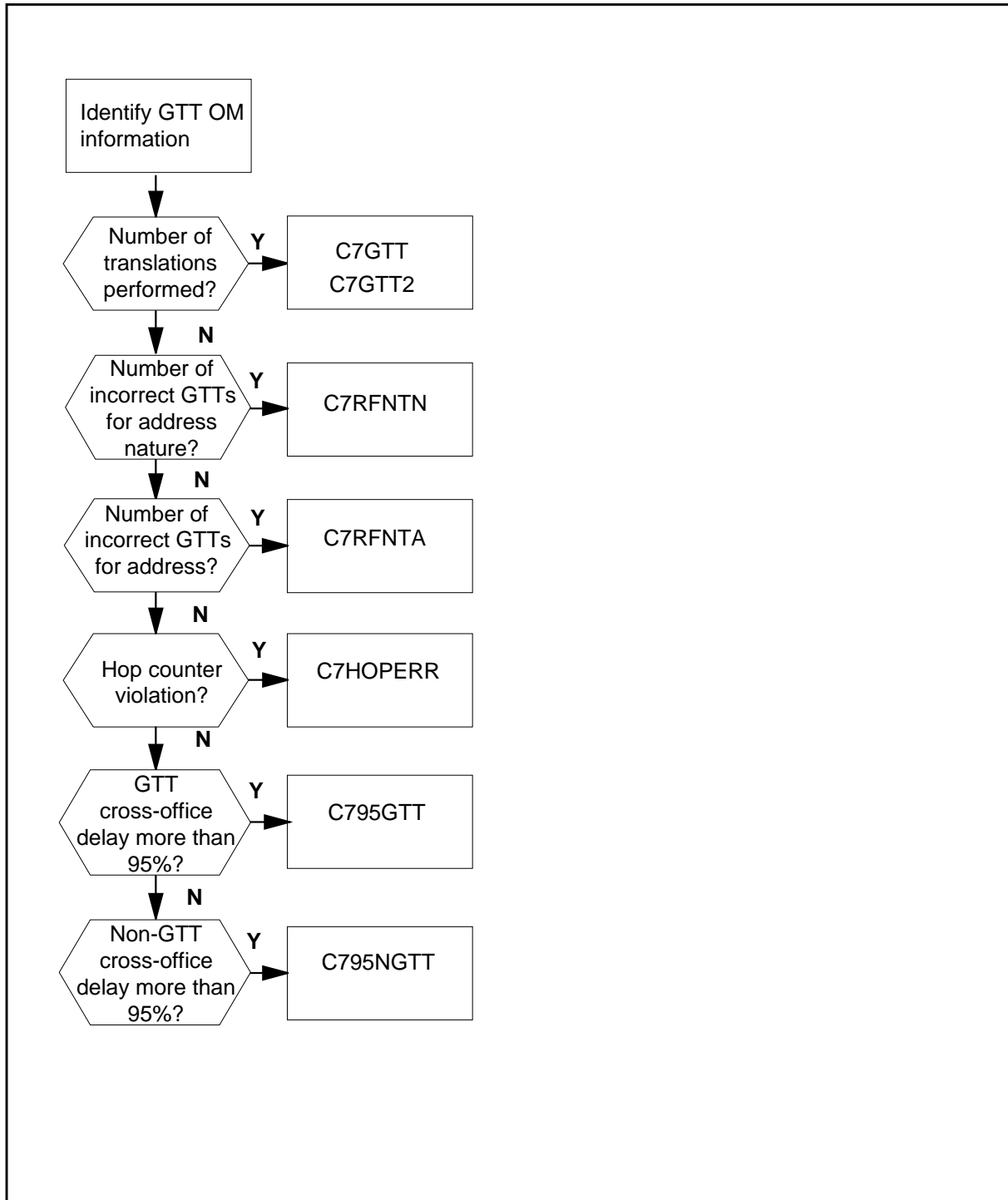
OM group C7GTLNK (continued)**OM group C7GTLNK registers**

OM group C7GTLNK (continued)

Register C7GTT

Register number of translations performed

Register C7GTT counts the number of GTTs performed per link.

Register C7GTT release history

Register C7GTT was introduced in TL10.

Associated registers

None

Associated logs

None

Extension registers

C7GTT2

Register C7RFNTN

Register routing failures for no translation of address nature

Register C7RFNTN counts the number of GTTs per link that resulted in error and could not be routed. The routing failed because an invalid field value in the CDPA exists.

Register C7RFNTN release history

Register C7RFNTN was introduced in TL10.

Associated registers

None

Associated logs

CCS241

Extension registers

None

Register C7RFNTA

Register routing failures for no translation of address

Register C7RFNTA counts the number of GTTs per link that resulted in error and could not be routed. The routing failed because an invalid field value in the called party address (CDPA) exists.

OM group C7GTLNK (continued)

Register C7RFNTA release history

Register C7RFNTA was introduced in TL10.

Associated registers

None

Associated logs

CCS241

Extension registers

None

Register C7HOPERR

Register hop counter violations

Register C7HOPERR counts the number of messages per link that have an signaling connection control part (SCCP) hop counter violation.

Register C7HOPERR release history

Register C7HOPERR was introduced in TL10.

Associated registers

None

Associated logs

CCS241

Extension registers

None

Register C795GTT

Register for MSUs with GTT that have delays greater than 95%

Register C795GTT counts the number of message signal unit (MSU) tests per link that require global title translation (GTT) and experience handling delays more than 95% of the time.

Register C795GTT release history

Register C795GTT was introduced in TL10.

Associated registers

None

OM group C7GTLNK (end)

Associated logs

N/A

Extension registers

None

Register C795NGTT

Register for MSUs without GTT that have delays greater than 95%

Register C795NGTT counts the number of MSU tests per link that do not require global title translation (GTT) and experience handling delays more than 95% of the time.

Register C795NGTT release history

Register C795NGTT was introduced in TL10.

Associated registers

None

Associated logs

N/A

Extension registers

None

OM group C7GTWSCR

OM description

C7 gateway screening (C7GTWSCR)

The C7GTWSCR counts messages discarded at a DMS STP by C7 gateway screening because the messages are written by users that are not authorized. A gateway signaling transfer point (STP) allows one Common Channeling Signaling 7 (CCS7) network access to another network's resources, such as authorized databases. CCS7 gateway screens incoming messages to a CCS7 network. The CCS7 screens based on the message transfer part (MTP) or the signal connection control part (SCCP) portions of a message, or both.

Registers in the OM group C7GTWSCR count the total number of screening failures. Registers in this group make separate counts of discards for each screening function. The registers increase the following causes:

- screening error in a message unit
- disallowed address
- disallowed originating point codes
- disallowed destination point codes
- incorrect service indicator, message priority, calling party address, affected point code, and incorrect subsystem status tests
- incorrect destination field
- incorrect translation type
- disallowed PC/SSN in a called party address
- incorrect called-party address (CDPA) routing indication, SSN, SCCP message type, and incorrect linkset group.

The system temporarily stores Operational measurement (OM) data in CCS7 link interface units (LIU7), high-speed link interface units (HLIU) and high-speed link routers (HSLR). The system sends the OM data to the computing module (CM) one minute before the active-to-holding OM transfer, or when the buffers are full.

Release history

The OM group C7GTWSCR was introduced in BCS27.

BCS30

Registers MSURJH01 and MSURJNIC added.

OM group C7GTWSCR (continued)

STP4.0

Register MSURJMT added.

TL11

Updated for high-speed links.

Registers

The OM group C7GTWSCR registers display on the MAP terminal as follows:

MSUDSCRD	MSUDSCR2	MSUSCRER	MSURJTM
MSURJOPC	MSURJDPC	MSURJSI	MSURJPRI
MSURJCPA	MSURJAPC	MSURJPCS	MSURJDST
MSURJTT	MSURJDSN	MSURJH01	MSURJNIC

Group structure

The OM group C7GTWSCR provides one tuple for each gateway linkset for each originating network, to a maximum of 1000.

Key field:

C7_LINKSET_NUMBER

Info field:

C7GTWSCR_OMINFO

The system reports tuples in the order that the linkset//operator number identification (ONI) pairs are allocated.

Associated OM groups

There are no OM associated groups.

Associated functional groups

The following functional groups associate with OM group C7GTWSCR:

- CCS7
- STP

OM group C7GTWSCR (continued)

Associated functionality codes

The associated functionality codes for OM group C7GTWSCR appear in the following table.

Functionality	Code
STP-Gateway Message Screening	NTX840AA

OM group C7GTWSCR (continued)

OM group C7GTWSCR registers

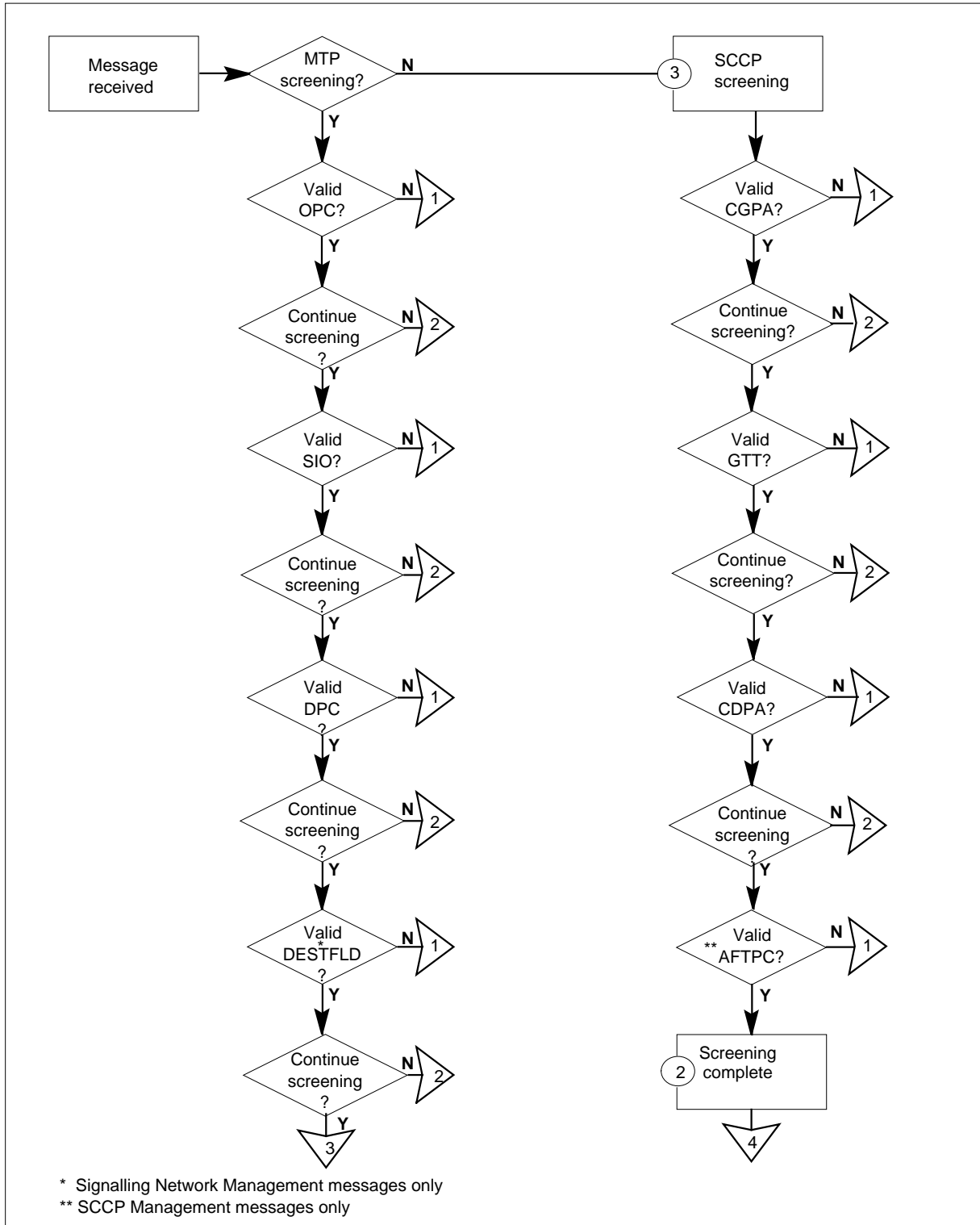

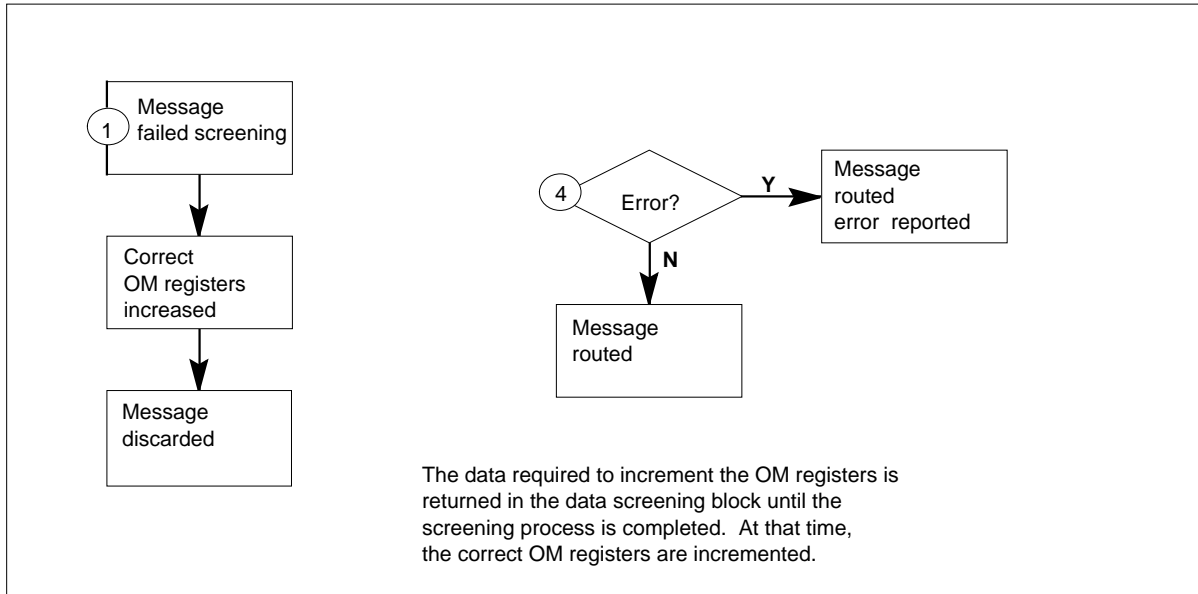
OM group C7GTWSCR (continued)**OM group C7GTWSCR registers (continued)****Register MSUDSCRD**

Message signal units discarded (MSUDSCRD)

Register MSUDSCRD counts message signal units (MSU) that the system discards because of gateway screening failures.

Register MSUDSCRD release history

Register MSUDSCRD was introduced in BCS27.

Associated registers

Register MSURJTM counts testing and maintenance MSUs that are discarded because of a disallowed address.

Register MSUSCRER counts MSUs that cause an error in a screening function.

Register MSURJOPC counts MSUs that are discarded because of a disallowed origination point code.

Register MSURJDPC counts MSUs that are discarded because of a disallowed destination point code.

Register MSURJSI counts MSUs that are discarded because of an invalid service indicator.

OM group C7GTWSCR (continued)

Register MSURJPRI counts MSUs that are discarded because of an invalid message priority.

Register MSURJCPA counts MSUs that are discarded because of an invalid calling party address (CGPA), subsystem number (SSN), CDPA routing indicator or linkset group.

Register MSURJAPC counts MSUs that are discarded because of an invalid affected PC/SSN.

Register MSURJPCS counts subsystem status test (SST) messages that are discarded because of an invalid affected PC/SSN.

Register MSURJDST counts MTP network management (NWM) messages that are discarded because of an invalid destination field.

Register MSURJTT counts SCCP MSUs that are discarded because of an invalid translation type.

Register MSURJDSN counts SCCP MSUs that are discarded because of a disallowed PC/SSN in the called party address.

Register MSURJH01 counts MSUs that are discarded because of an invalid H0 or H1 codes.

Register MSURJNIC counts MSUs that are discarded because of an invalid network indicator field in the service information octet.

$MSUDSCRD + MSUDSCR2 \times 65536 = MSUSCRER + MSURJTM + MSURJOPC + MSURJDPC + MSURJSI + MSURJPRI + MSURJCPA + MSURJAPC + MSURJPCS + MSURJDST + MSURJTT + MSURJDSN + MSURJH01 + MSURJNIC$

Associated logs

The system generates log CCS500 when the MSUs that gateway screening functions discard exceed the threshold value for MSUs. The threshold value for MSUs is entered in table C7GTWLKS.

The system generates log CCS502 each time a gateway screening function discards a message. The log report includes the date, time, and reason for discard.

Extension registers

MSUDSCR2

OM group C7GTWSCR (continued)

Register MSURJAPC

Message signal units rejected, caused by incorrect PC/SSN.

Register MSURJAPC counts MSUs that the system discards because of an affected PC/SSN that are not correct.

Register MSURJAPC release history

Register MSURJAPC was introduced in BCS27.

Associated registers

Register MSUDSCRD counts MSUs that are discarded because of gateway screening failures.

Register MSUSCRER counts MSUs that cause an error in a screening function.

Register MSURJTM counts testing and maintenance MSUs that are discarded because of a disallowed address.

Register MSURJOPC counts MSUs that are discarded because of a disallowed origination point code.

Register MSURJDPC counts MSUs that are discarded because of a disallowed destination point code.

Register MSURJSI counts MSUs that are discarded because of an invalid service indicator.

Register MSURJPRI counts MSUs that are discarded because of an invalid message priority.

Register MSURJCPA counts MSUs that are discarded because of an invalid CGPA, SSN, CDPA routing indicator or linkset group.

Register MSURJPCS counts SST messages that are discarded because of an invalid affected PC/SSN.

Register MSURJDST counts MTP NWM messages that are discarded because of an invalid destination field.

Register MSURJTT counts SCCP MSUs that are discarded because of an invalid translation type.

OM group C7GTWSCR (continued)

Register MSURJDSN counts SCCP MSUs that are discarded because of a disallowed PC/SSN in the called party address.

Register MSURJH01 counts MSUs that are discarded because of an invalid H0 or H1 codes.

Register MSURJNIC counts MSUs that are discarded because of an invalid network indicator field in the service information octet.

$MSUDSCRD + MSUDSCR2 \times 65536 = MSUSCRER + MSURJTM + MSURJOPC + MSURJDPC + MSURJSI + MSURJPRI + MSURJCPA + MSURJAPC + MSURJPCS + MSURJDST + MSURJTT + MSURJDSN + MSURJH01 + MSURJNIC$

Associated logs

The system generates CCS502 each time a gateway screening function discards a message. The log report includes the date, time, and reason for discard.

Register MSURJCPA

Message signal units rejected because of an invalid calling party address (CGPA).

Register MSURJCPA counts MSUs discarded because of an invalid CGPA or an invalid linkset group.

Register MSURJCPA release history

Register MSURJCPA was introduced in BCS27.

Associated registers

Register MSUDSCRD counts MSUs that are discarded because of gateway screening failures.

Register MSUSCRER counts MSUs that cause an error in a screening function.

Register MSURJTM counts testing and maintenance MSUs that are discarded because of a disallowed address.

Register MSURJOPC counts MSUs that are discarded because of a disallowed origination point code.

Register MSURJDPC counts MSUs that are discarded because of a disallowed destination point code.

OM group C7GTWSCR (continued)

Register MSURJSI counts MSUs that are discarded because of an invalid service indicator.

Register MSURJPRI counts MSUs that are discarded because of an invalid message priority.

Register MSURJAPC counts MSUs that are discarded because of an invalid affected PC/SSN.

Register MSURJPCS counts SST messages that are discarded because of an invalid affected PC/SSN.

Register MSURJDST counts MTP NWM messages that are discarded because of an invalid destination field.

Register MSURJTT counts SCCP MSUs that are discarded because of an invalid translation type.

Register MSURJDSN counts SCCP MSUs that are discarded because of a disallowed PC/SSN in the called party address.

Register MSURJH01 counts MSUs that are discarded because of an invalid H0 or H1 codes.

Register MSURJNIC counts MSUs that are discarded because of an invalid network indicator field in the service information octet.

$MSUDSCRD + MSUDSCR2 \times 65536 = MSUSCRER + MSURJTM + MSURJOPC + MSURJDPC + MSURJSI + MSURJPRI + MSURJCPA + MSURJAPC + MSURJPCS + MSURJDST + MSURJTT + MSURJDSN + MSURJH01 + MSURJNIC$

Associated logs

The system generates CCS502 each time a gateway screening function discards a message. The log report includes the date, time, and reason for discard.

Register MSURJDPC

Message signal units rejected, caused by a disallowed destination point code (MSURJDPC)

MSURJDPC counts MSUs that are discarded because of a disallowed destination point code.

OM group C7GTWSCR (continued)

Register MSURJDPC release history

Register MSURJDPC was introduced in BCS27.

Associated registers

Register MSUDSCRD counts MSUs that are discarded because of gateway screening failures.

Register MSUSCRER counts MSUs that cause an error in a screening function.

Register MSURJTM counts testing and maintenance MSUs that are discarded because of a disallowed address.

Register MSURJOPC counts MSUs that are discarded because of a disallowed origination point code.

Register MSURJSI counts MSUs that are discarded because of an invalid service indicator.

Register MSURJPRI counts MSUs that are discarded because of an invalid message priority.

Register MSURJCPA counts MSUs that are discarded because of an invalid CGPA, SSN, CDPA routing indicator or linkset group.

Register MSURJAPC counts MSUs that are discarded because of an invalid affected PC/SSN.

Register MSURJPCS counts SST messages that are discarded because of an invalid affected PC/SSN.

Register MSURJDST counts MTP NWM messages that are discarded because of an invalid destination field.

Register MSURJTT counts SCCP MSUs that are discarded because of an invalid translation type.

Register MSURJDSN counts SCCP MSUs that are discarded because of a disallowed PC/SSN in the called party address.

Register MSURJH01 counts MSUs that are discarded because of an invalid H0 or H1 codes.

Register MSURJNIC counts MSUs that are discarded because of an invalid network indicator field in the service information octet.

OM group C7GTWSCR (continued)

MSUDSCRD + MSUDSCR2 x 65536 = MSUSCRER + MSURJTM +
MSURJOPC + MSURJDPC + MSURJSI + MSURJPRI + MSURJCPA +
MSURJAPC + MSURJPCS + MSURJDST + MSURJTT + MSURJDSN +
MSURJH01 + MSURJNIC

Associated logs

The system generates CCS502 each time a gateway screening function discards a message. The log includes the date, time, and reason for discard.

Register MSURJDSN

SCCP MSUs rejected, caused by a disallowed point code and subsystem in the called party address (MSURJDSN)

Register MSURJDSN counts SCCP MSUs that the system discards because of a point code and subsystem (PC/SSN) in the called party address that are not allowed.

Register MSURJDSN release history

Register MSURJDSN was introduced in BCS27.

Associated registers

Register MSUDSCRD counts MSUs that are discarded due to gateway screening failures.

Register MSUSCRER counts MSUs that cause an error in a screening function.

Register MSURJTM counts testing and maintenance MSUs that are discarded because of a disallowed address.

Register MSURJOPC counts MSUs that are discarded because of a disallowed origination point code.

Register MSURJDPC counts MSUs that are discarded because of a disallowed destination point code.

Register MSURJSI counts MSUs that are discarded because of an invalid service indicator.

Register MSURJPRI counts MSUs that are discarded because of an invalid message priority.

Register MSURJCPA counts MSUs that are discarded because of an invalid CGPA, SSN, CDPA routing indicator or linkset group.

OM group C7GTWSCR (continued)

Register MSURJAPC counts MSUs that are discarded because of an invalid affected PC/SSN.

Register MSURJPCS counts SST messages that are discarded because of an invalid affected PC/SSN.

Register MSURJDST counts MTP NWM messages that are discarded because of an invalid destination field.

Register MSURJTT counts SCCP MSUs that are discarded because of an invalid translation type.

Register MSURJH01 counts MSUs that are discarded because of an invalid H0 or H1 codes.

Register MSURJNIC counts MSUs that are discarded because of an invalid network indicator field in the service information octet.

$MSUDSCRD + MSUDSCR2 \times 65536 = MSUSCRER + MSURJTM + MSURJOPC + MSURJDPC + MSURJSI + MSURJPRI + MSURJCPA + MSURJAPC + MSURJPCS + MSURJDST + MSURJTT + MSURJDSN + MSURJH01 + MSURJNIC$

Associated logs

The system generates log CCS502 each time a gateway screening function discards a message. The log report includes the date, time, and reason for discard.

Register MSURJDST

MTP NWM messages rejected, caused by an incorrect destination field.

Register MSURJDST counts MTP NWM messages that the system discards because of a destination field that is not correct.

Register MSURJDST release history

Register MSURJDST was introduced in BCS27.

Associated registers

Register MSUDSCRD counts MSUs that are discarded because of gateway screening failures.

Register MSUSCRER counts MSUs that cause an error in a screening function.

OM group C7GTWSCR (continued)

Register MSURJTM counts testing and maintenance MSUs that are discarded because of a disallowed address.

Register MSURJOPC counts MSUs that are discarded because of a disallowed origination point code.

Register MSURJDPC counts MSUs that are discarded because of a disallowed destination point code.

Register MSURJSI counts MSUs that are discarded because of an invalid service indicator.

Register MSURJPRI counts MSUs that are discarded because of an invalid message priority.

Register MSURJCPA counts MSUs that are discarded because of an invalid CGPA, SSN, CDPA routing indicator or linkset group.

Register MSURJAPC counts MSUs that are discarded because of an invalid affected PC/SSN.

Register MSURJPCS counts SST messages that are discarded because of an invalid affected PC/SSN.

Register MSURJTT counts SCCP MSUs that are discarded because of an invalid translation type.

Register MSURJDSN counts SCCP MSUs that are discarded because of a disallowed PC/SSN in the called party address.

Register MSURJH01 counts MSUs that are discarded because of an invalid H0 or H1 codes.

Register MSURJNIC counts MSUs that are discarded because of an invalid network indicator field in the service information octet.

MSUDSCRD + MSUDSCR2 x 65536 = MSUSCRER + MSURJTM + MSURJOPC + MSURJDPC + MSURJSI + MSURJPRI + MSURJCPA + MSURJAPC + MSURJPCS + MSURJDST + MSURJTT + MSURJDSN + MSURJH01 + MSURJNIC

Associated logs

The system generates CCS502 each time a gateway screening function discards a message. The log report includes the date, time, and reason for discard.

OM group C7GTWSCR (continued)

Register MSURJH01

Message signal units discarded, caused by incorrect H0 and H1 codes

Register MSURJH01 counts MSUs that the system discards because of an H0 and H1 codes that is not correct.

Register MSURJH01 release history

Register MSURJH01 was introduced in BCS30.

Associated registers

Register MSUDSCRD counts MSUs that are discarded because of gateway screening failures.

Register MSUSCRER counts MSUs that cause an error in a screening function.

Register MSURJTM counts testing and maintenance MSUs that are discarded because of a disallowed address.

Register MSURJOPC counts MSUs that are discarded because of a disallowed origination point code.

Register MSURJDPC counts MSUs that are discarded because of a disallowed destination point code.

Register MSURJSI counts MSUs that are discarded because of an invalid service indicator.

Register MSURJPRI counts MSUs that are discarded because of an invalid message priority.

Register MSURJCPA counts MSUs that are discarded because of an invalid CGPA, SSN, CDPA routing indicator or linkset group.

Register MSURJAPC counts MSUs that are discarded because of an invalid affected PC/SSN.

Register MSURJPCS counts SST messages that are discarded because of an invalid affected PC/SSN.

Register MSURJTT counts SCCP MSUs that are discarded because of an invalid translation type.

OM group C7GTWSCR (continued)

Register MSURJDSN counts SCCP MSUs that are discarded because of a disallowed PC/SSN in the called party address.

Register MSURJDST counts MTP NWM messages that are discarded because of an invalid destination field.

Register MSURJNIC counts MSUs that are discarded because of an invalid network indicator field in the service information octet.

MSUDSCRD + MSUDSCR2 x 65536 = MSUSCRER + MSURJTM + MSURJOPC + MSURJDPC + MSURJSI + MSURJPRI + MSURJCPA + MSURJAPC + MSURJPCS + MSURJDST + MSURJTT + MSURJDSN + MSURJH01 + MSURJNIC

Associated logs

The system generates CCS502 each time a gateway screening function discards a message. The log report includes the date, time, and reason for discard.

Register MSURJNIC

Message signal units discarded, caused by incorrect network indicator field

Register MSURJNIC counts MSUs that the system discards because of a network indicator field in the service information octet that is not correct.

Register MSURJNIC release history

Register MSURJNIC was introduced in BCS30.

Associated registers

Register MSUDSCRD counts MSUs that are discarded because of gateway screening failures.

Register MSUSCRER counts MSUs that cause an error in a screening function.

Register MSURJTM counts testing and maintenance MSUs that are discarded because of a disallowed address.

Register MSURJOPC counts MSUs that are discarded because of a disallowed origination point code.

Register MSURJDPC counts MSUs that are discarded because of a disallowed destination point code.

OM group C7GTWSCR (continued)

Register MSURJSI counts MSUs that are discarded because of an invalid service indicator.

Register MSURJPRI counts MSUs that are discarded because of an invalid message priority.

Register MSURJCPA counts MSUs that are discarded because of an invalid CGPA, SSN, CDPA routing indicator or linkset group.

Register MSURJAPC counts MSUs that are discarded because of an invalid affected PC/SSN.

Register MSURJPCS counts SST messages that are discarded because of an invalid affected PC/SSN.

Register MSURJTT counts SCCP MSUs that are discarded because of an invalid translation type.

Register MSURJDSN counts SCCP MSUs that are discarded because of a disallowed PC/SSN in the called party address.

Register MSURJH01 counts MSUs that are discarded because of an invalid H0 or H1 codes.

Register MSURJDST counts MTP network management messages that are discarded because of an invalid destination field.

$MSUDSCRD + MSUDSCR2 \times 65536 = MSUSCRER + MSURJTM + MSURJOPC + MSURJDPC + MSURJSI + MSURJPRI + MSURJCPA + MSURJAPC + MSURJPCS + MSURJDST + MSURJTT + MSURJDSN + MSURJH01 + MSURJNIC$

Associated logs

The system generates CCS502 each time a gateway screening function discards a message. The log report includes the date, time, and reason for discard.

Register MSURJOPC

Message signal units rejected, caused by a disallowed origination point code.

Register MSURJOPC counts MSUs that the system discards because of an origination point code that is not allowed.

OM group C7GTWSCR (continued)

Register MSURJOPC release history

Register MSURJOPC was introduced in BCS27.

Associated registers

Register MSUDSCRD counts MSUs that are discarded because of gateway screening failures.

Register MSUSCRER counts MSUs that cause an error in a screening function.

Register MSURJTM counts testing and maintenance MSUs that are discarded because of a disallowed address.

Register MSURJDPC counts MSUs that are discarded because of a disallowed destination point code.

Register MSURJSI counts MSUs that are discarded because of an invalid service indicator.

Register MSURJPRI counts MSUs that are discarded because of an invalid message priority.

Register MSURJCPA counts MSUs that are discarded because of an invalid CGPA, SSN, CDPA routing indicator or linkset group.

Register MSURJAPC counts MSUs that are discarded because of an invalid affected PC/SSN.

Register MSURJPCS counts SST messages that are discarded because of an invalid affected PC/SSN.

Register MSURJDST counts MTP NWM messages that are discarded because of an invalid destination field.

Register MSURJTT counts SCCP MSUs that are discarded because of an invalid translation type.

Register MSURJDSN counts SCCP MSUs that are discarded because of a disallowed PC/SSN in the called party address.

Register MSURJH01 counts MSUs that are discarded because of an invalid H0 or H1 codes.

Register MSURJNIC counts MSUs that are discarded because of an invalid network indicator field in the service information octet.

OM group C7GTWSCR (continued)

MSUDSCRD + MSUDSCR2 x 65536 = MSUSCRER + MSURJTM +
MSURJOPC + MSURJDPC + MSURJSI + MSURJPRI + MSURJCPA +
MSURJAPC + MSURJPCS + MSURJDST + MSURJTT + MSURJDSN +
MSURJH01 + MSURJNIC

Associated logs

The system generates CCS502 each time a gateway screening function discards a message. The log report includes the date, time, and reason for discard.

Register MSURJPCS

Subsystem status test messages rejected, caused by an incorrect affected point code and subsystem (MSURJPCS)

Register MSURJPCS counts subsystem status test (SST) messages that the system discards because of an affected point code and subsystem (PC/SSN) that are not correct.

Register MSURJPCS release history

Register MSURJPCS was introduced in BCS27.

Associated registers

Register MSUDSCRD counts MSUs that are discarded because of gateway screening failures.

Register MSUSCRER counts MSUs that cause an error in a screening function.

Register MSURJTM counts testing and maintenance MSUs that are discarded because of a disallowed address.

Register MSURJOPC counts MSUs that are discarded because of a disallowed origination point code.

Register MSURJDPC counts MSUs that are discarded because of a disallowed destination point code.

Register MSURJSI counts MSUs that are discarded because of an invalid service indicator.

Register MSURJPRI counts MSUs that are discarded because of an invalid message priority.

OM group C7GTWSCR (continued)

Register MSURJCPA counts MSUs that are discarded because of an invalid CGPA, SSN, CDPA routing indicator or linkset group.

Register MSURJAPC counts MSUs that are discarded because of an invalid affected PC/SSN.

Register MSURJDST counts MTP NWM messages that are discarded because of an invalid destination field.

Register MSURJTT counts SCCP MSUs that are discarded because of an invalid translation type.

Register MSURJDSN counts SCCP MSUs that are discarded because of a disallowed PC/SSN in the called party address.

Register MSURJH01 counts MSUs that are discarded because of an invalid H0 or H1 codes.

Register MSURJNIC counts MSUs that are discarded because of an invalid network indicator field in the service information octet.

MSUDSCRD + MSUDSCR2 x 65536 = MSUSCRER + MSURJTM + MSURJOPC + MSURJDPC + MSURJSI + MSURJPRI + MSURJCPA + MSURJAPC + MSURJPCS + MSURJDST + MSURJTT + MSURJDSN + MSURJH01 + MSURJNIC

Associated logs

The system generates CCS502 each time a gateway screening function discards a message. The log report includes the date, time, and reason for discard.

Register MSURJPRI

Message signal units rejected, caused by an incorrect message priority

Register MSURJPRI counts MSUs that the system discards because of a message priority that is not correct.

Register MSURJPRI release history

Register MSURJPRI was introduced in BCS27.

Associated registers

Register MSUDSCRD counts MSUs that are discarded because of gateway screening failures.

OM group C7GTWSCR (continued)

Register MSUSCRER counts MSUs that cause an error in a screening function.

Register MSURJTM counts testing and maintenance MSUs that are discarded because of a disallowed address.

Register MSURJOPC counts MSUs that are discarded because of a disallowed origination point code.

Register MSURJDPC counts MSUs that are discarded because of a disallowed destination point code.

Register MSURJSI counts MSUs that are discarded because of an invalid service indicator.

Register MSURJCPA counts MSUs that are discarded because of an invalid CGPA, SSN, CDPA routing indicator or linkset group.

Register MSURJAPC counts MSUs that are discarded because of an invalid affected PC/SSN.

Register MSURJPCS counts SST messages that are discarded because of an invalid affected PC/SSN.

Register MSURJDST counts MTP NWM messages that are discarded because of an invalid destination field.

Register MSURJTT counts SCCP MSUs that are discarded because of an invalid translation type.

Register MSURJDSN counts SCCP MSUs that are discarded because of a disallowed PC/SSN in the called party address.

Register MSURJH01 counts MSUs that are discarded because of an invalid H0 or H1 codes.

Register MSURJNIC counts MSUs that are discarded because of an invalid network indicator field in the service information octet.

$MSUDSCRD + MSUDSCR2 \times 65536 = MSUSCRER + MSURJTM + MSURJOPC + MSURJDPC + MSURJSI + MSURJPRI + MSURJCPA + MSURJAPC + MSURJPCS + MSURJDST + MSURJTT + MSURJDSN + MSURJH01 + MSURJNIC$

OM group C7GTWSCR (continued)

Associated logs

The system generates CCS502 each time a gateway screening function discards a message. The log report includes the date, time, and reason for discard.

Register MSURJSI

Message signal units rejected, caused by an invalid service indicator (MSURJSI)

Register MSURJSI counts MSUs that the system discards because of a service indicator that is not correct.

Register MSURJSI release history

Register MSURJSI was introduced in BCS27.

Associated registers

Register MSUDSCRD counts MSUs that are discarded because of gateway screening failures.

Register MSUSCRER counts MSUs that cause an error in a screening function.

Register MSURJTM counts testing and maintenance MSUs that are discarded because of a disallowed address.

Register MSURJOPC counts MSUs that are discarded because of a disallowed origination point code.

Register MSURJDPC counts MSUs that are discarded because of a disallowed destination point code.

Register MSURJPRI counts MSUs that are discarded because of an invalid message priority.

Register MSURJCPA counts MSUs that are discarded because of an invalid CGPA, SSN, CDPA routing indicator or linkset group.

Register MSURJAPC counts MSUs that are discarded because of an invalid affected PC/SSN.

Register MSURJPCS counts SST messages that are discarded because of an invalid affected PC/SSN.

OM group C7GTWSCR (continued)

Register MSURJDST counts MTP NWM messages that are discarded because of an invalid destination field.

Register MSURJTT counts SCCP MSUs that are discarded because of an invalid translation type.

Register MSURJDSN counts SCCP MSUs that are discarded because of a disallowed PC/SSN in the called party address.

Register MSURJH01 counts MSUs that are discarded because of an invalid H0 or H1 codes.

Register MSURJNIC counts MSUs that are discarded because of an invalid network indicator field in the service information octet.

$MSUDSCRD + MSUDSCR2 \times 65536 = MSUSCRER + MSURJTM + MSURJOPC + MSURJDPC + MSURJSI + MSURJPRI + MSURJCPA + MSURJAPC + MSURJPCS + MSURJDST + MSURJTT + MSURJDSN + MSURJH01 + MSURJNIC$

Associated logs

The system generates CCS502 each time a gateway screening function discards a message. The log report includes the date, time, and reason for discard.

Register MSURJTM

Testing and maintenance message signal units rejected

Register MSURJTM counts testing and maintenance MSUs that the system discards because of an address that is not allowed.

Register MSURJTM release history

Register MSURJTM was introduced in BCS27.

Associated registers

Register MSUDSCRD counts MSUs that are discarded because of gateway screening failures.

Register MSUSCRER counts MSUs that cause an error in a screening function.

Register MSURJOPC counts MSUs that are discarded because of a disallowed origination point code.

OM group C7GTWSCR (continued)

Register MSURJDPC counts MSUs that are discarded because of a disallowed destination point code.

Register MSURJSI counts MSUs that are discarded because of an invalid service indicator.

Register MSURJPRI counts MSUs that are discarded because of an invalid message priority.

Register MSURJCPA counts MSUs that are discarded because of an invalid CGPA, SSN, CDPA routing indicator or linkset group.

Register MSURJAPC counts MSUs that are discarded because of an invalid affected PC/SSN.

Register MSURJPCS counts SST messages that are discarded because of an invalid affected PC/SSN.

Register MSURJDST counts MTP NWM messages that are discarded because of an invalid destination field.

Register MSURJTT counts SCCP MSUs that are discarded because of an invalid translation type.

Register MSURJDSN counts SCCP MSUs that are discarded because of a disallowed PC/SSN in the called party address.

Register MSURJH01 counts MSUs that are discarded because of an invalid H0 or H1 codes.

Register MSURJNIC counts MSUs that are discarded because of an invalid network indicator field in the service information octet.

MSUDSCRD + MSUDSCR2 x 65536 = MSUSCRER + MSURJTM + MSURJOPC + MSURJDPC + MSURJSI + MSURJPRI + MSURJCPA + MSURJAPC + MSURJPCS + MSURJDST + MSURJTT + MSURJDSN + MSURJH01 + MSURJNIC

Associated logs

The system generates CCS50S each time a gateway screening function discards a message. The log report includes the date, time, and reason for discard.

OM group C7GTWSCR (continued)

Register MSURJTT

SCCP MSUs caused by an incorrect translation type (MSURJTT)

Register MSURJTT counts SCCP MSUs that the system discards because of a translation type that is not correct.

Register MSURJTT release history

Register MSURJTT was introduced in BCS27.

Associated registers

Register MSUDSCRD counts MSUs that are discarded because of gateway screening failures.

Register MSUSCRER counts MSUs that cause an error in a screening function.

Register MSURJTM counts testing and maintenance MSUs that are discarded because of a disallowed address.

Register MSURJOPC counts MSUs that are discarded because of a disallowed origination point code.

Register MSURJDPC counts MSUs that are discarded because of a disallowed destination point code.

Register MSURJSI counts MSUs that are discarded because of an invalid service indicator.

Register MSURJPRI counts MSUs that are discarded because of an invalid message priority.

Register MSURJCPA counts MSUs that are discarded because of an invalid CGPA, SSN, CDPA routing indicator or linkset group.

Register MSURJAPC counts MSUs that are discarded because of an invalid affected PC/SSN.

Register MSURJPCS counts SST messages that are discarded because of an invalid affected PC/SSN.

Register MSURJDST counts MTP NWM messages that are discarded because of an invalid destination field.

OM group C7GTWSCR (continued)

Register MSURJDSN counts SCCP MSUs that are discarded because of a disallowed PC/SSN in the called party address.

Register MSURJH01 counts MSUs that are discarded because of an invalid H0 or H1 codes.

Register MSURJNIC counts MSUs that are discarded because of an invalid network indicator field in the service information octet.

$MSUDSCRD + MSUDSCR2 \times 65536 = MSUSCRER + MSURJTM + MSURJOPC + MSURJDPC + MSURJSI + MSURJPRI + MSURJCPA + MSURJAPC + MSURJPCS + MSURJDST + MSURJTT + MSURJDSN + MSURJH01 + MSURJNIC$

Associated logs

The system generates CCS502 each time a gateway screening function discards a message. The log report includes the date, time, and reason for discard.

Register MSUSCRER

Message signal unit screening errors (MSUSCRER)

Register MSUSCRER MSUs that cause an error in a screening function.

Register MSUSCRER release history

Register MSUSCRER was introduced in BCS27.

Associated registers

Register MSUDSCRD counts MSUs that the system discards because of gateway screening failures.

Register MSURJTM counts testing and maintenance MSUs that the system rejects because of an address that is not allowed.

Register MSURJOPC counts MSUs that the system discards because of an origination point code that is not allowed.

Register MSURJDPC counts MSUs that the system discards because of a destination point code that is not allowed.

Register MSURJSI counts MSUs that the system discards because of a service indicator that is not correct.

OM group C7GTWSCR (end)

Register MSURJPRI counts MSUs that the system discards because of a message priority that is not correct.

Register MSURJCPA counts MSUs that are discarded because of an invalid CGPA, SSN, CDPA routing indicator or linkset group.

Register MSURJAPC counts MSUs that the system discards because of an affected point code and subsystem (PC/SSN) that are not correct.

Register MSURJPCS counts SSTs messages that the system discards because of an affected point code and subsystem (PC/SSN) that are not correct.

Register MSURJDST counts MTPs network management (NWM) messages that the system discards because of a destination field that is not correct.

Register MSURJTT counts SCCPs message signal units that the system discards because of a translation type that is not correct.

Register MSURJDSN counts SCCPs message signal units that the system discards because of a translation type that is not correct.

Register MSURJH01 counts MSUs that the system discards because of an H0 and H1 code that is not correct.

Register MSURJNIC counts MSUs that the system discards because of a network indicator field in the service information octet that is not correct.

$MSUDSCRD + MSUDSCR2 \times 65536 = MSUSCRER + MSURJTM + MSURJOPC + MSURJDPC + MSURJSI + MSURJPRI + MSURJCPA + MSURJAPC + MSURJPCS + MSURJDST + MSURJTT + MSURJDSN + MSURJH01 + MSURJNIC$

Associated logs

The system generates CCS503 generates each time a gateway screening function fails because of an error. The log report includes the date, time, and the screening function in which the error occurs.

OM group C7GWSCCP

OM description

CCS7 gateway signaling connection control part (C7GWSCCP)

The OM group C7GWSCCP monitors the performance and use of the CCS7 international gateway signaling connection control part (SCCP).

The OM group C7GWSCCP contains three registers that count:

- incoming SCCP messages that the system discards because of an overload in the message switch and buffer for CCS7 (MSB7)
- messages that the central control process

Release history

The OM group C7GWSCCP was introduced in BCS31.

Registers

The OM group C7GWSCCP registers appear on the MAP terminal as follows:



C7THROWN C7MSGCC C7MSGCC2

Group structure

The OM group C7GWSCCP provides one tuple per office

Key field:

There is no key field

Info field:

There is no key field

Associated OM groups

The OM group C7SCCP provides information on the performance and use of the CCS7 SCCP.

Associated functional groups

The following functional groups associate with OM group C7GWSCCP:

- DMS-300
- MSB7-Message switch and buffer for CCS7

OM group C7GWSCCP (continued)

Associated functionality codes

The functionality codes associated with OM group C7GWSCCP appear in the following table.

Functionality	Code
Signaling Connection Part (MSB7)-DMS300	NTXK51AA

OM group C7GWSCCP registers

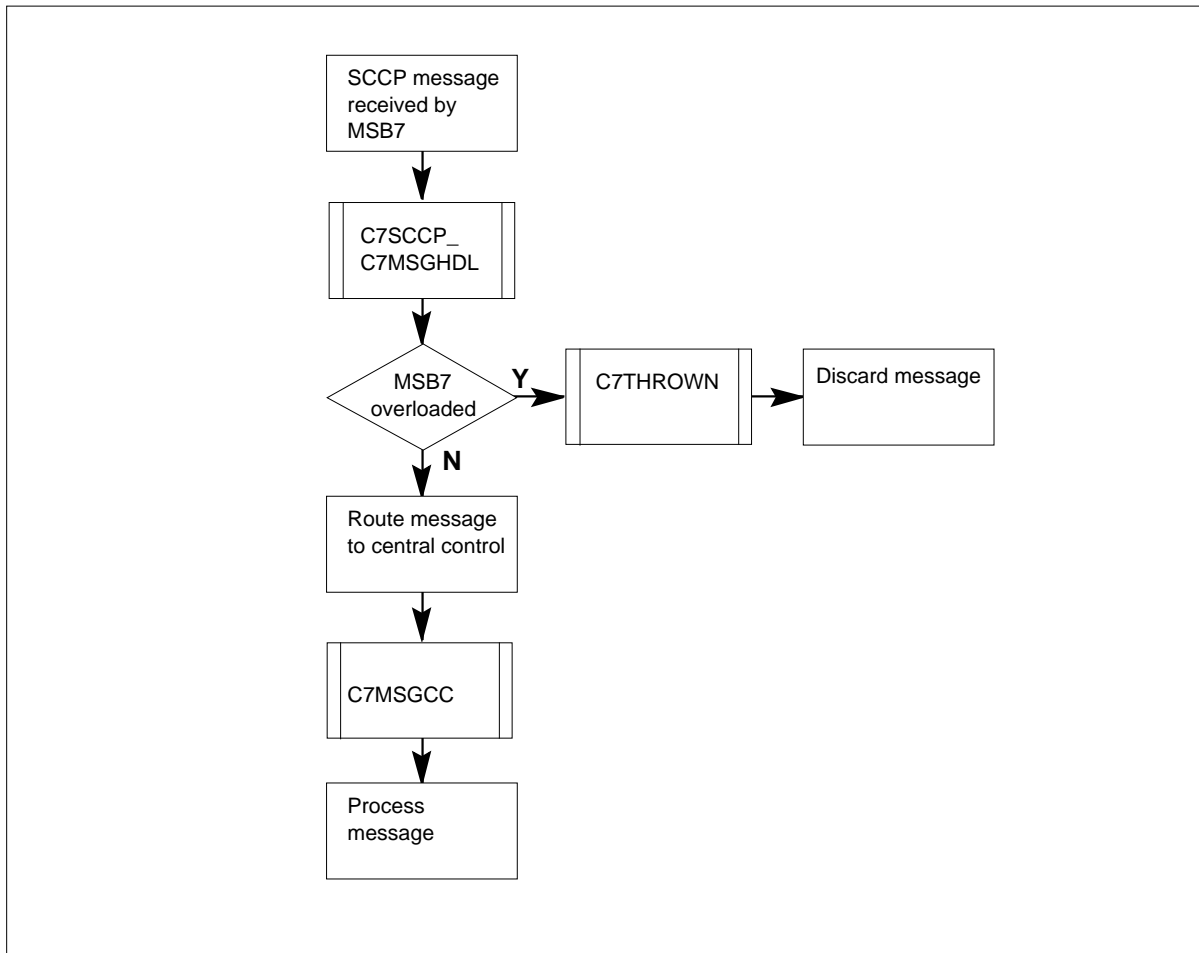

Register C7THROWN

Messages discarded (C7THROWN)

OM group C7GWSCCP (end)

Register C7THROWN counts incoming SCCP messages the system discards because of an overload in the message switch and buffer for CCS7 (MSB7).

Register C7THROWN release history

Register C7THROWN was introduced in BCS31.

Associated registers

Register C7SCCP_C7MSGHDL counts SCCP messages that the international gateway SCCP switch handle.

Register C7MSGCC counts SCCP messages that the central control process.

$$C7SCCP_C7MSGHDL = C7THROWN + C7MSGCC$$

Associated logs

There are no associated logs.

Register C7MSGCC

Messages processed by central control (C7MSGCC)

Register C7MSGCC counts SCCP messages that the central control process.

Register C7MSGCC release history

Register C7MSGCC was introduced in BCS31.

Associated registers

Register C7SCCP_C7MSGHDL counts SCCP messages that the international gateway SCCP switch handle.

Register C7THROWN counts incoming SCCP messages the system discards because of an overload in the message switch and buffer (MSB7).

$$C7SCCP_C7MSGHDL = C7THROWN + C7MSGCC$$

Associated logs

There are no associated logs.

Extension registers

C7MSGCC2

OM group C7HSLAL1

OM description

CCS7 High-speed Link Signaling ATM Adaptation Layer Events Group 1

C7HSLAL1 provides information related to the operation of the CCS7 high-speed link asynchronous transfer mode (ATM) adaptation layer.

Release history

OM group C7HSLAL1 was introduced in TL10.

Registers

The following OM group C7HSLAL1 registers display on the MAP terminal:

C7SSPT1	C7SSPT2	C7SSPRT1	C7SSPRT2
C7SSPOT1	C7SSPOT2	C7SPORT1	C7SPORT2
C7SPR1	C7SPR2	C7SPOR1	C7SPOR2
C7STPT1	C7STPT2	C7STPR1	C7STPR2
C7STPOT1	C7STPOT2	C7STPOR1	C7STPOR2

Group structure

OM group C7HSLAL1 provides a tuple for each key.

Key field:

C7_LINKSET_NUMBER. Number in the range 0 to 254 is used as an index into table C7LKSET.

Info field:

C7LINK_OMINFO. The Info field has a two-part key: CLLI and C7_SIGLINK_CODE. CLLI is the common language location identifier of the linkset that owns the link. The C7_SIGLINK_CODE is a number from 0 to 15 that identifies the link in the linkset.

Associated OM groups

C7HSLAL2 provides information on CCS7 high-speed link ATM adaptation layer operations.

C7HSLATM provides information on CCS7 high-speed link ATM layer events.

C7HSLCAR provides information on CCS7 high-speed link digital carriers.

OM group C7HSLAL1 (continued)

C7LINK1 counts failures and recoveries of a CCS7 link.

C7LINK2 provides information on calls and congestion for a CCS7 link.

C7LINK3 monitors traffic and performance of message signal units on a CCS7 link.

C7LKSET provides CCS7 linkset performance information.

Associated functional groups

The following functional groups are associated with OM group C7HSLAL1:

- Common Channel Signaling 7 (CCS7)

Associated functionality codes

The functionality codes associated with OM group C7HSLAL1 are shown in the following table.

Functionality	Code
TEL CCS7 Base	TEL00008

OM group C7HSLAL1 (continued)

OM group C7HSLAL1 SSCOP PDU received

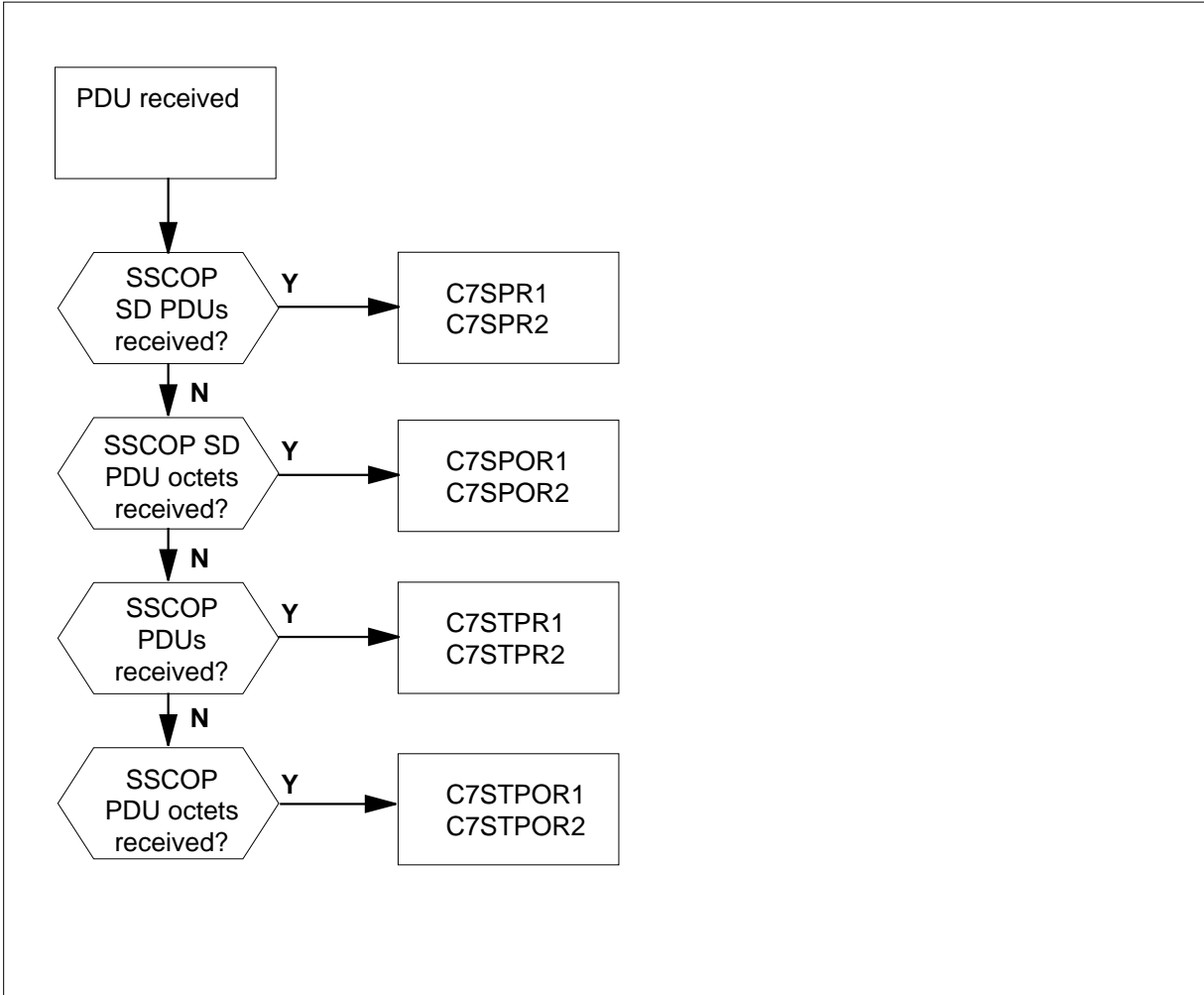

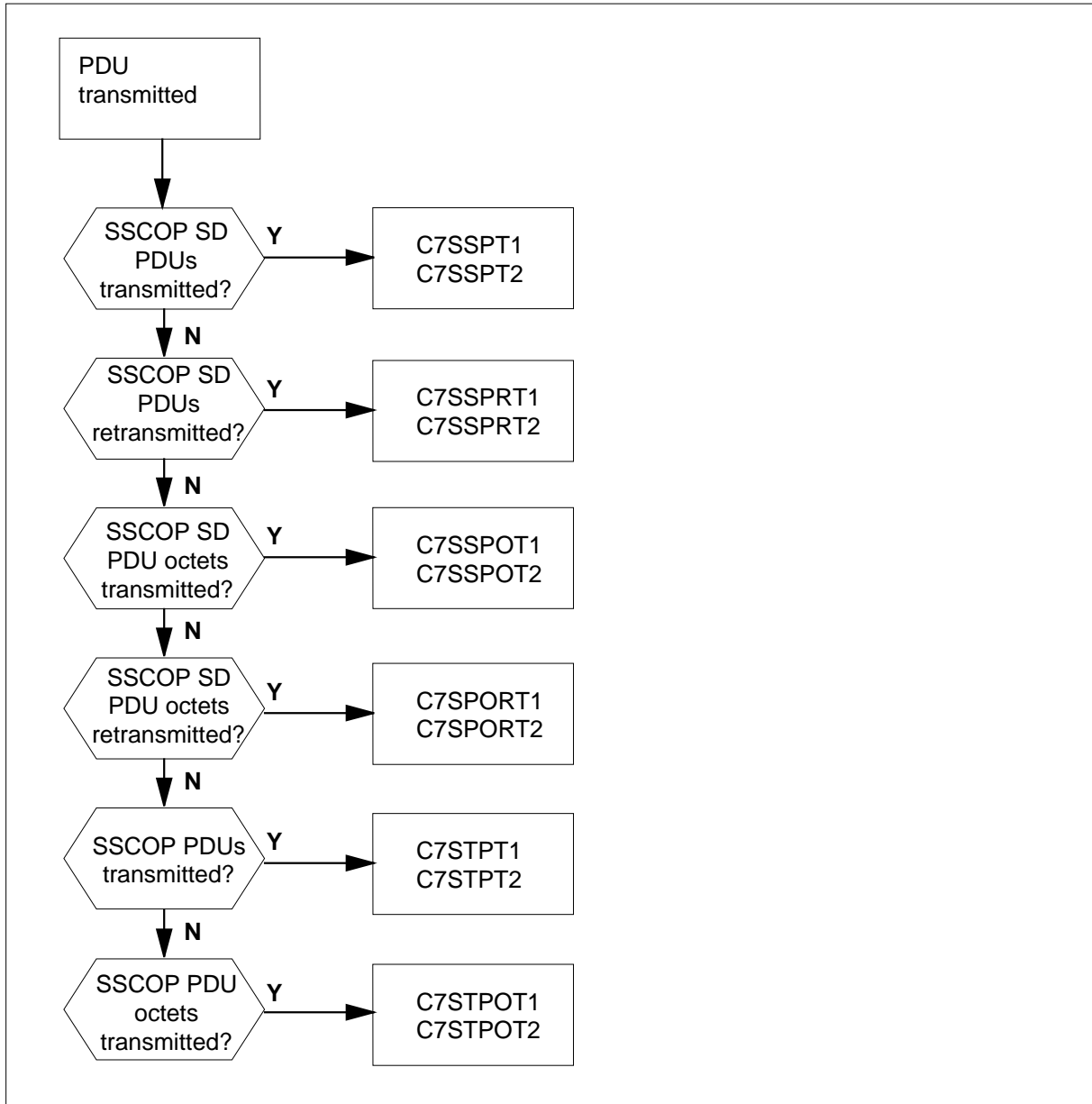
OM group C7HSLAL1 (continued)**OM group C7HSLAL1 SCCOP PDU transmitted****Register C7SSPT1**

SSCOP SD PDUs Transmitted

Register C7SSPT1 counts the number of transmitted Service Specific Connection Oriented Protocol (SSCOP) sequence data (SD) packet data units (PDU).

OM group C7HSLAL1 (continued)

Register C7SSPT1 release history

Register C7SSPT1 was introduced in TL10.

Associated registers

None

Associated logs

None

Extension registers

C7SSPT2

Register C7SSPRT1

SSCOP SD PDUs Retransmitted

Register C7SSPRT1 counts the number of retransmitted SSCOP SD PDUs.

Register C7SSPRT1 release history

Register C7SSPRT1 was introduced in TL10.

Associated registers

None

Associated logs

None

Extension registers

C7SSPRT2

Register C7SSPOT1

SSCOP SD PDU Octets Transmitted

Register C7SSPOT1 counts the number of transmitted SSCOP SD PDU octets.

Register C7SSPOT1 release history

Register C7SSPOT1 was introduced in TL10.

Associated registers

None

Associated logs

None

OM group C7HSLAL1 (continued)

Extension registers

C7SSPOT2

Register C7SPORT1

SSCOP SD PDU Octets Retransmitted

Register C7SPORT1 counts the number of retransmitted SSCOP SD PDU octets.

Register C7SPORT1 release history

Register C7SPORT1 was introduced in TL10.

Associated registers

None

Associated logs

None

Extension registers

C7SPORT2

Register C7SPR1

SSCOP SD PDUs Received

Register C7SPR1 counts the number of received SSCOP SD PDUs.

Register C7SPR1 release history

Register C7SPR1 was introduced in TL10.

Associated registers

None

Associated logs

None

Extension registers

C7SPR2

Register C7SPOR1

SSCOP SD PDU Octets Received

Register C7SPOR1 counts the number of received SSCOP SD PDU octets.

OM group C7HSLAL1 (continued)

Register C7SPOR1 release history

Register C7SPOR1 was introduced in TL10.

Associated registers

None

Associated logs

None

Extension registers

C7SPOR2

Register C7STPT1

Total SSCOP PDUs Transmitted

Register C7STPT1 counts the total number of transmitted SSCOP PDUs.

Register C7STPT1 release history

Register C7STPT1 was introduced in TL10.

Associated registers

None

Associated logs

None

Extension registers

C7STPT2

Register C7STPR1

Total SSCOP PDUs Received

C7STPR1 counts the total number of received SSCOP PDUs.

Register C7STPR1 release history

Register C7STPR1 was introduced in TL10.

Associated registers

None

Associated logs

None

OM group C7HSLAL1 (end)

Extension registers

C7STPR2

Register C7STPOT1

Total SSCOP PDU Octets Transmitted

Register C7STPOT1 counts the total number of transmitted SSCOP PDU octets.

Register C7STPOT1 release history

Register C7STPOT1 was introduced in TL10.

Associated registers

None

Associated logs

None

Extension registers

C7STPOT2

Register C7STPOR1

Total SSCOP PDU Octets Received

Register C7STPOR1 counts the total number of received SSCOP PDU octets.

Register C7STPOR1 release history

Register C7STPOR1 was introduced in TL10.

Associated registers

None

Associated logs

None

Extension registers

C7STPOR2

OM group C7HSLAL2

OM description

CCS7 High-speed Link Signaling ATM Adaptation Layer Events Group 2

C7HSLAL2 provides information on CCS7 high-speed link asynchronous transfer mode (ATM) adaptation layer operations.

Release history

OM group C7HSLAL2 was introduced in TL10.

Registers

The following OM group C7HSLAL2 registers display on the MAP terminal as follows:

C7SCSEC	C7SCDIS	C7SCIFL	C7SCRRSY
C7HTSCSC	C7SEPSEC	C7USPDUR	C7ISPDUR
C7SPRLEE	C7HTSEPC	C7SPDURR	C7HTSPRR
C7SDISS	C7SDISS2	C7LOCE	C7CDLOC
C7CDFEPO	C7CDLPO		

Group structure

OM group C7HSLAL2 provides a tuple for each key.

Key field:

C7_LINKSET_NUMBER. Number in the range 0 to 254, used as an index into table C7LKSET.

Info field:

C7LINK_OMINFO. The Info field has a two-part key: CLLI and C7_SIGLINK_CODE. CLLI is the common language location identifier (CLLI) of the linkset that owns the link. The C7_SIGLINK_CODE is a number from 0 to 15 that identifies the link in the linkset.

Associated OM groups

C7HSLAL1 provides information on CCS7 high-speed link ATM adaptation layer operations.

C7HSLATM provides information on CCS7 high-speed link ATM layer events.

C7HSLCAR provides information on CCS7 high-speed link digital carriers.

C7LINK1 counts failures and recoveries of a CCS7 link.

OM group C7HSLAL2 (continued)

C7LINK2 provides information on calls and congestion for a CCS7 link.

C7LINK3 monitors traffic and performance of message signal units on a CCS7 link.

C7LKSET provides CCS7 linkset performance information.

Associated functional groups

The following functional groups are associated with OM group C7HSLAL2:

- Common Channel Signaling 7 (CCS7)

Associated functionality codes

The functionality codes associated with OM group C7HSLAL2 are shown in the following table.

Functionality	Code
TEL CCS7 Base	TEL00008

OM group C7HSLAL2 (continued)

OM group C7HSLAL2 registers: SSCOP PDU error

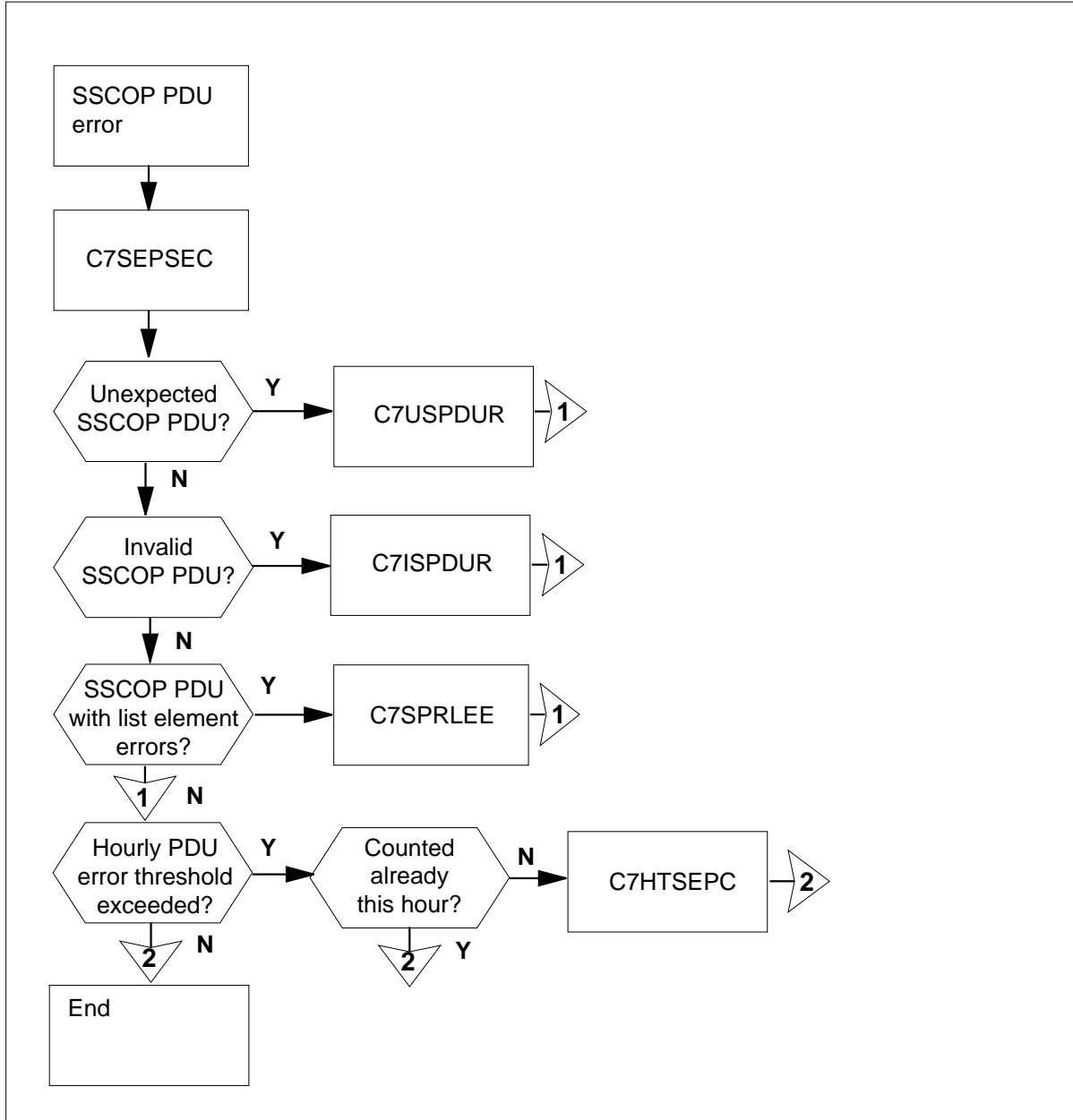

OM group C7HSLAL2 (continued)

OM group C7HSLAL2 registers: SSCOP connection error

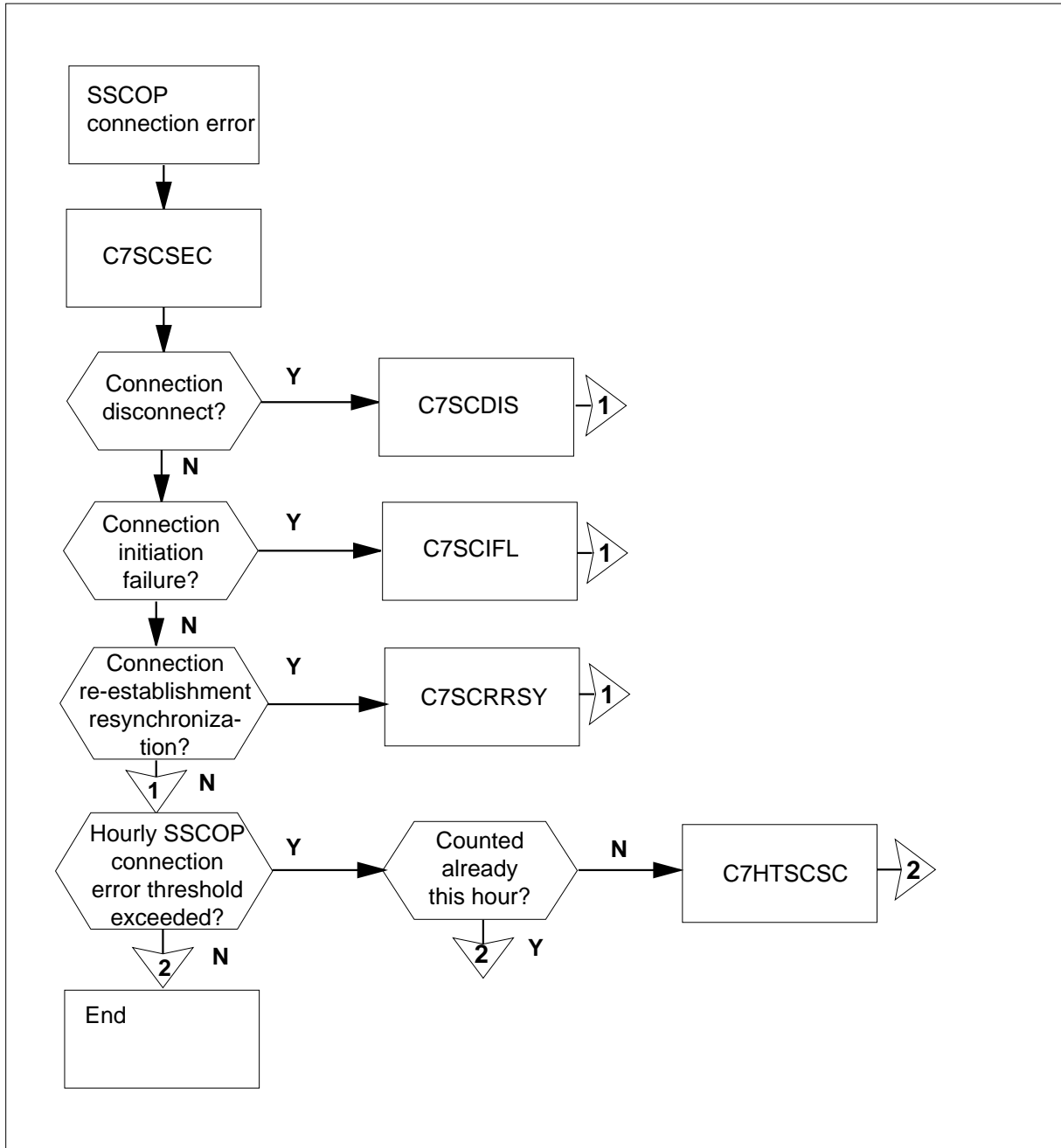

OM group C7HSLAL2 (continued)

OM group C7HSLAL2 registers: SD PDU transmitted

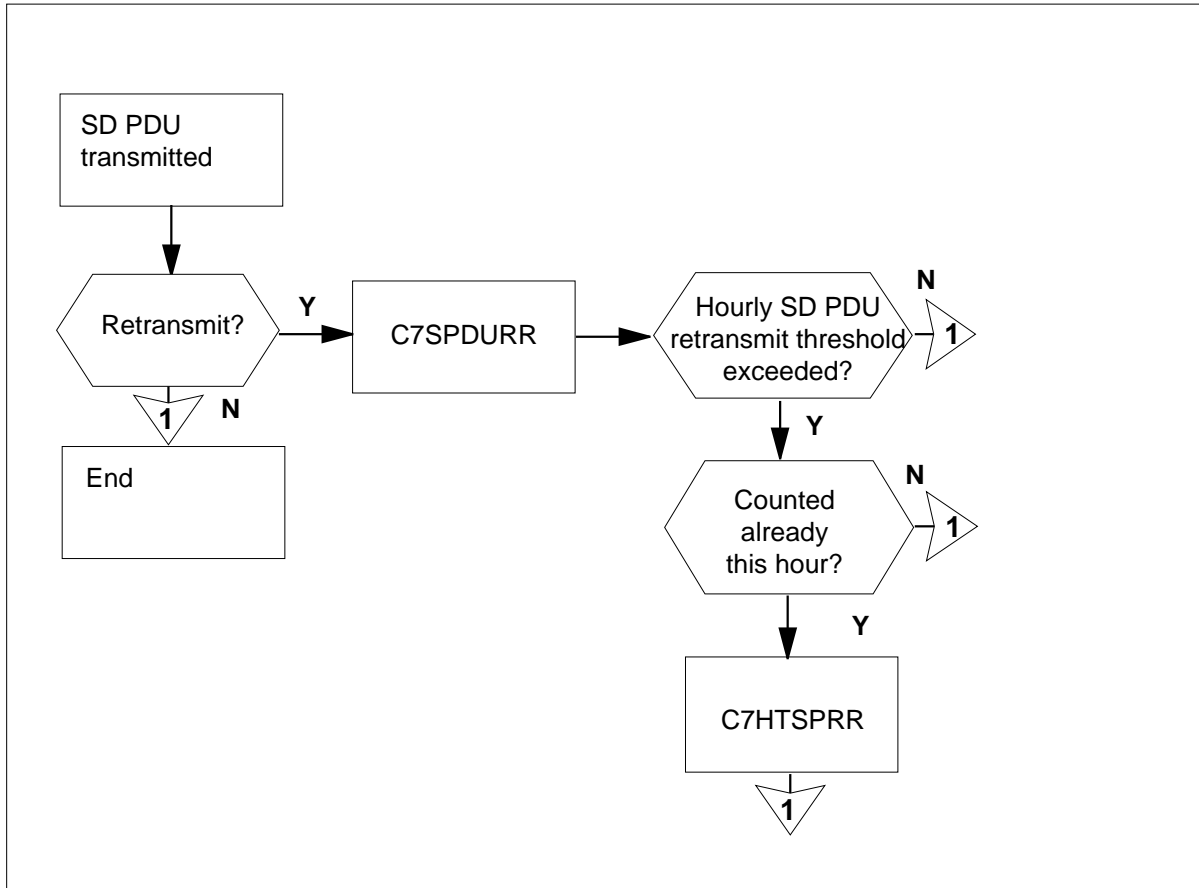

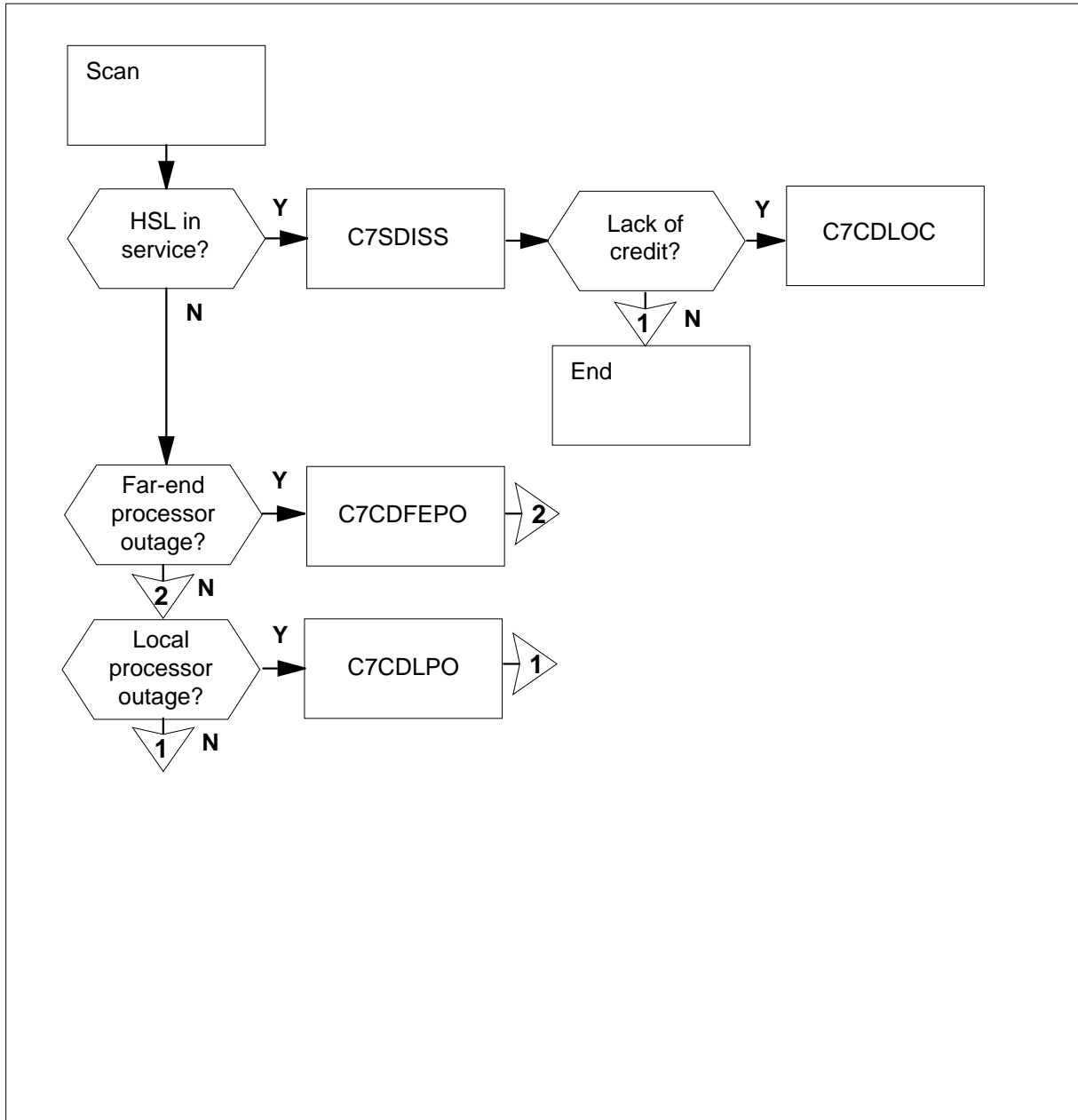
OM group C7HSLAL2 (continued)**OM group C7HSLAL2 registers: Scan**

OM group C7HSLAL2 (continued)

OM group C7HSLAL2 registers: Lack of credit event

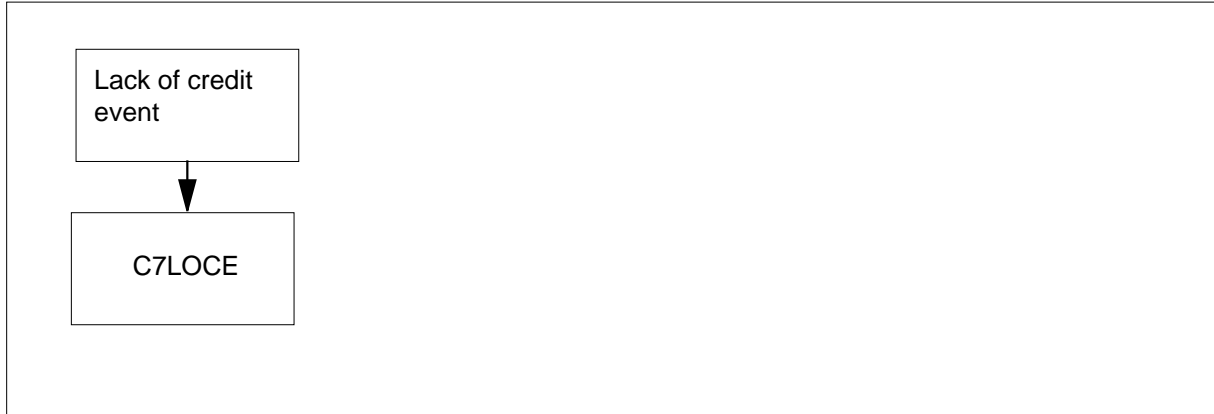

Register C7SCSEC

SSCOP Connection Sum-of-errors Counter

Register C7SCSEC counts Service Specific Connection Oriented Protocol (SSCOP) connection errors.

Register C7SCSEC release history

Register C7SCSEC was introduced in TL10.

Associated registers

None

Associated logs

CCS120 provides detailed information on links exceeding the hourly performance threshold.

Extension registers

None

Register C7SCDIS

SSCOP Connection Disconnect

Register C7SCDIS counts lost SSCOP connections.

Register C7SCDIS release history

Register C7SCDIS was introduced in TL10.

Associated registers

None

OM group C7HSLAL2 (continued)

Associated logs

CCS120 provides detailed information on links exceeding the hourly performance threshold.

Extension registers

None

Register C7SCIFL

SSCOP Connection Initiation Failure

Register C7SCIFL counts SSCOP connection initiation failures.

Register C7SCIFL release history

Register C7SCIFL was introduced in TL10.

Associated registers

None

Associated logs

CCS120 provides detailed information on links exceeding the hourly performance threshold.

Extension registers

None

Register C7SCRRSY

SSCOP Connection Re-establishment/Resynchronization

Register C7SCRRSY counts SSCOP connection re-establishments and resynchronizations.

Register C7SCRRSY release history

Register C7SCRRSY was introduced in TL10.

Associated registers

None

Associated logs

CCS120 provides detailed information on links exceeding the hourly performance threshold.

Extension registers

None

OM group C7HSLAL2 (continued)

Register C7HTSCSC

Hourly Marginal Performance Thresholds Exceeded for SSCOP Connection Sum-of-errors Counter.

Register C7HTSCSC counts the number of instances in which the total SSCOP connections exceed the hourly marginal performance threshold. The threshold is datafilled in table OFCVAR, parameter C7_SSCOP.CON_SLMPR_THRESHOLD.

Register C7HTSCSC release history

Register C7HTSCSC was introduced in TL10.

Associated registers

None

Associated logs

CCS120 provides detailed information on links exceeding the hourly performance threshold.

Extension registers

None

Register C7SEPSEC

SSCOP Errored PDUs Sum-of-errors Counter

Register C7SEPSEC counts errored packet data units (PDU).

Register C7SEPSEC release history

Register C7SEPSEC was introduced in TL10.

Associated registers

None

Associated logs

CCS120 provides detailed information on links exceeding the hourly performance threshold.

Extension registers

None

Register C7USPDUR

Unexpected SSCOP PDUs Received

OM group C7HSLAL2 (continued)

Register C7USPDUR counts the number of unexpected SSCOP PDUs received.

Register C7USPDUR release history

Register C7USPDUR was introduced in TL10.

Associated registers

None

Associated logs

CCS120 provides detailed information on links exceeding the hourly performance threshold.

Extension registers

None

Register C7ISPDUR

Invalid SSCOP PDUs Received

Register C7ISPDUR counts the number of invalid SSCOP PDUs received.

Register C7ISPDUR release history

Register C7ISPDUR was introduced in TL10.

Associated registers

None

Associated logs

CCS120 provides detailed information on links exceeding the hourly performance threshold.

Extension registers

None

Register C7SPRLEE

SSCOP PDUs Received with List Element Errors

Register C7SPRLEE counts the number of SSCOP PDUs received with list element errors.

Register C7SPRLEE release history

Register C7SPRLEE was introduced in TL10.

OM group C7HSLAL2 (continued)

Associated registers

None

Associated logs

CCS120 provides detailed information on links exceeding the hourly performance threshold.

Extension registers

None

Register C7HTSEPC

Hourly Marginal Performance Thresholds Exceeded for SSCOP Errored PDUs Sum-of-errors Counter

Register C7HTSEPC counts the number of times that the total SSCOP errored PDUs exceed the hourly marginal performance threshold. The threshold is datafilled in table OFCVAR, parameter C7_PDU_ESTOR_SLMPR_THRESHOLD.

Register C7HTSEPC release history

Register C7HTSEPC was introduced in TL10.

Associated registers

None

Associated logs

None

Extension registers

None

Register C7SPDURR

SSCOP SD PDUs Transmitted Requiring Retransmission

Register C7SPDURR counts the number of transmitted SSCOP SD PDUs that require retransmission.

Register C7SPDURR release history

Register C7SPDURR was introduced in TL10.

Associated registers

None

OM group C7HSLAL2 (continued)

Associated logs

CCS120 provides detailed information on links exceeding the hourly performance threshold.

Extension registers

None

Register C7HTSPRR

Hourly Marginal Performance Thresholds Exceeded for SSCOP SD PDUs Transmitted Requiring Retransmission

Register C7HTSPRR counts the number of times that the total transmitted SSCOP SD PDUs requiring retransmission have exceeded the hourly marginal performance threshold. The threshold is datafilled in table OFCVAR, parameter C7_SSCOP_RETIANS_SLMPR_THRESHOLD.

Register C7HTSPRR release history

Register C7HTSPRR was introduced in TL10.

Associated registers

None

Associated logs

None

Extension registers

None

Register C7SDISS

Duration in the In-service State

Register C7SDISS counts the duration of in-service states.

Register C7SDISS release history

Register C7SDISS was introduced in TL10.

Associated registers

None

Associated logs

None

OM group C7HSLAL2 (continued)

Extension registers

C7SDISS2

Register C7LOCE

Lack of Credit Events

Register C7LOCE counts the number of lack-of-credit events.

Register C7LOCE release history

Register C7LOCE was introduced in TL10.

Associated registers

None

Associated logs

None

Extension registers

None

Register C7CDLOC

Cumulative Duration of Lack of Credit

Register C7CDLOC counts the cumulative duration of lack-of-credit events, in units of centiseconds.

Register C7CDLOC release history

Register C7CDLOC was introduced in TL10.

Associated registers

None

Associated logs

None

Extension registers

None

Register C7CDFEPO

Cumulative Duration of Far-end Processor Outage

Register C7CDFEPO release history

Register C7CDFEPO was introduced in TL10.

OM group C7HSLAL2 (end)

Register C7CDFEPO counts the cumulative duration of far-end processor outages in units of centiseconds.

Associated registers

None

Associated logs

None

Extension registers

None

Register C7CDLPO

Cumulative Duration of Local Processor Outage

Register C7CDLPO counts the cumulative duration of local processor outages in units of centiseconds.

Register C7CDFEPO release history

Register C7CDLPO was introduced in TL10.

Associated registers

None

Associated logs

None

Extension registers

None

OM group C7HSLATM

OM description

CCS7 High-speed Link ATM Layer Events

C7HSLATM provides information on CCS7 high-speed link asynchronous transfer mode (ATM) layer operations.

Release history

OM group C7HSLATM was introduced in TL10.

Registers

The following OM group C7HSLATM registers display on the MAP terminal as follows:

C7RCNDCV	C7RCNDC2	C7TCNDCV	C7TCNDC2
C7RCAUI	C7RCAUI2	C7TCAUI	C7TCAUI2
C7DISHEC	C7OCDAN	C7DISPE	

Group structure

OM group C7HSLATM provides a tuple for each key.

Key field:

C7_LINKSET_NUMBER. Number in the range 0 to 254, used as an index into table C7LKSET.

Info field:

C7LINK_OMINFO. The Info field has a two-part key: CLLI and C7_SIGLINK_CODE. CLLI is the common language location identifier (CLLI) of the linkset that owns the link. The C7_SIGLINK_CODE is a number from 0 to 15 that identifies the link in the linkset.

Associated OM groups

C7HSLAAL provides information on CCS7 high-speed link signaling ATM adaptation (SAAL) layer events.

C7HSLATM provides information on CCS7 high-speed link ATM layer events.

C7HSLCAR provides information on CCS7 high-speed link digital carriers.

C7LINK1 counts failures and recoveries of a CCS7 link.

OM group C7HSLATM (continued)

C7LINK2 provides information on calls and congestion for a CCS7 link.

C7LINK3 monitors traffic and performance of message signal units on a CCS7 link.

C7LKSET provides CCS7 linkset performance information.

Associated functional groups

The following functional groups are associated with OM group C7HSLATM:

- Common Channel Signaling 7 (CCS7)

Associated functionality codes

The functionality codes associated with OM group C7HSLATM are shown in the following table.

Functionality	Code
TEL CCS7 Base	TEL00008

OM group C7HSLATM (continued)

OM group C7HSLATM registers logic flow

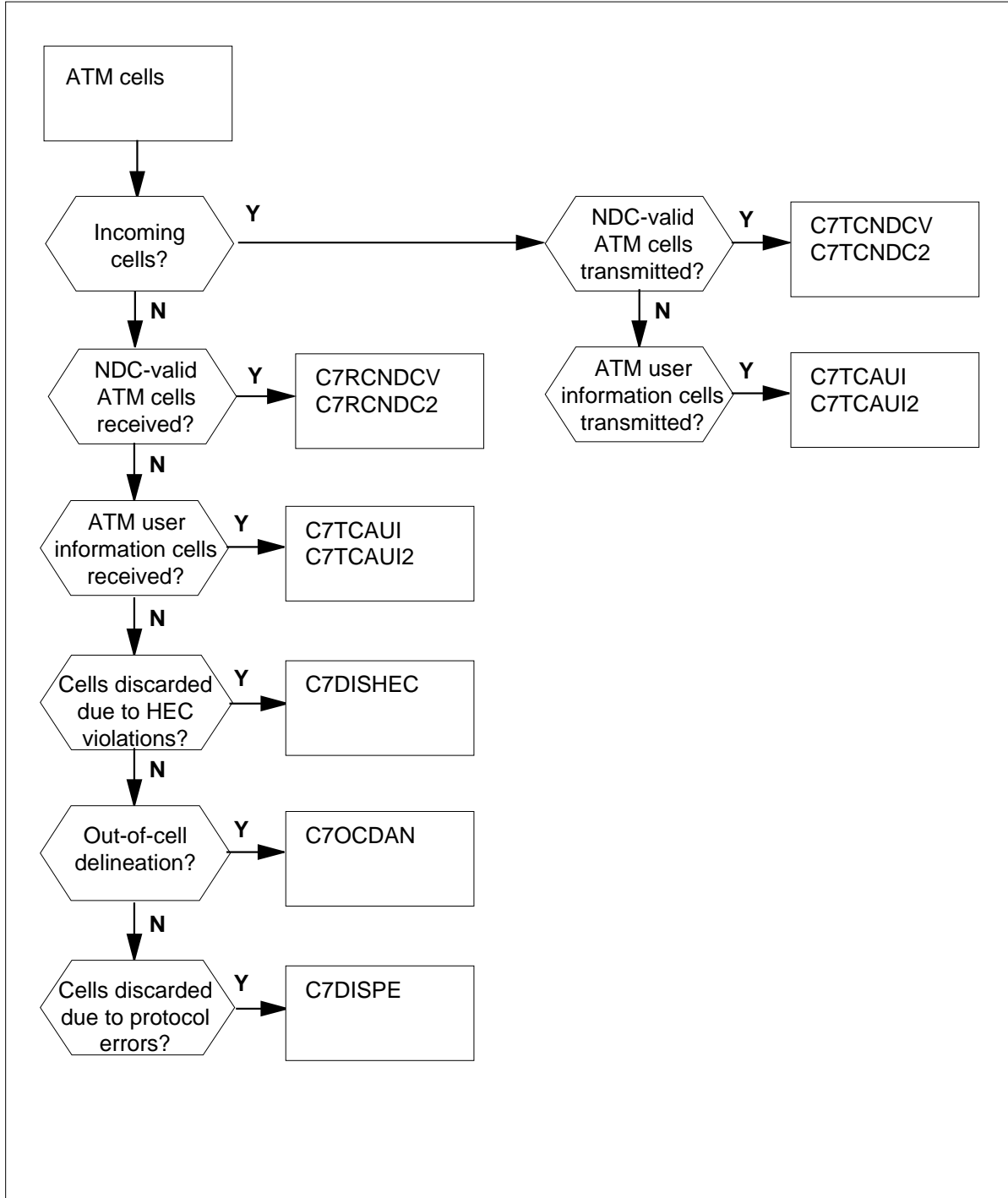

OM group C7HSLATM (continued)

Register C7RCNDCV

Total Received NDC-valid ATM Cells

Register C7RCNDCV counts the total number of network data collection (NDC)-valid ATM cells received. NDC-valid cells are the cells specified as part of the NDC.

Register C7RCNDCV release history

Register C7RCNDCV was introduced in TL10.

Associated registers

None

Associated logs

None

Extension registers

C7RCNDC2

Register C7TCNDCV

Total Transmitted NDC-valid ATM Cells

Register C7TCNDCV counts the total number of NDC-valid ATM cells transmitted.

Register C7TCNDCV release history

Register C7TCNDCV was introduced in TL10.

Associated registers

None

Associated logs

None

Extension registers

C7TCNDC2

Register C7RCAUI

Total Received ATM User Information Cells

Register C7RCAUI counts the total number of ATM user information cells received.

OM group C7HSLATM (continued)

Register C7RCAUI release history

Register C7RCAUI was introduced in TL10.

Associated registers

None

Associated logs

None

Extension registers

C7RCAUI2

Register C7TCAUI

Total Transmitted ATM User Information Cells

Register C7TCAUI counts the total number of ATM user information cells transmitted.

Register C7TCAUI release history

Register C7TCAUI was introduced in TL10.

Associated registers

None

Associated logs

None

Extension registers

C7TCAUI2

Register C7DISHEC

Number of Cells Discarded Due to Header Error Control (HEC) Violations

Register C7DISHEC counts the number of cells discarded due to header error control violations.

Register C7DISHEC release history

Register C7DISHEC was introduced in TL10.

Associated registers

None

OM group C7HSLATM (end)

Associated logs

CCS120 provides detailed information on links exceeding the hourly performance threshold.

Extension registers

None

Register C7OCDAN

Out-of-cell Delineation (OCD) Anomalies

Register C7OCDAN counts out-of-cell delineation anomalies.

Register C7OCDAN release history

Register C7OCDAN was introduced in TL10.

Associated registers

None

Associated logs

CCS120 provides detailed information on links exceeding the hourly performance threshold.

Extension registers

None

Register C7DISPE

Number of Cells Discarded Due to Protocol (ATM-layer Header) Errors

Register C7DISPE counts the number of cells discarded due to protocol (ATM-layer header) errors.

Register C7DISPE release history

Register C7DISPE was introduced in TL10.

Associated registers

None

Associated logs

CCS120 provides detailed information on links exceeding the hourly performance threshold.

Extension registers

None

OM group C7HSLCAR

OM description

CCS7 High-speed Link Carrier Events

C7HSLCAR provides information on Common Channel Signaling 7 (CCS7) high-speed link digital carrier operations.

Release history

OM group C7HSLCAR was introduced in TL10.

Registers

The following OM group C7HSLCAR registers display on the MAP terminal as follows:

C7CVL	C7SESL	C7LOSSL
C7ESP	C7SESP	C7SASP
C7FCP	C7AISSP	C7ESLF
C7ESPF	C7SESPF	C7SEFSPF
C7CSPF	C7FCPF	

Group structure

OM group C7HSLCAR provides a tuple for each key.

Key field:

C7_LINKSET_NUMBER. Number in the range 0 to 254, used as an index into table C7LKSET.

Info field:

C7LINK_OMINFO. The Info field has a two-part key: CLLI and C7_SIGLINK_CODE. CLLI is the common language location identifier of the linkset that owns the link. The C7_SIGLINK_CODE is a number from 0 to 15 that identifies the link in the linkset.

Associated OM groups

C7HSLAL1 and C7HSLAL2 provide information on CCS7 high-speed link signaling ATM adaptation (SAAL) layer events.

OM group C7HSLCAR (continued)

C7HSLATM provides information on CCS7 high-speed link ATM layer events.

C7LINK1 counts failures and recoveries of a CCS7 link.

C7LINK2 provides information on calls and congestion for a CCS7 link.

C7LINK3 monitors traffic and performance of message signal units on a CCS7 link.

C7LKSET provides CCS7 linkset performance information.

Associated functional groups

The following functional groups are associated with OM group C7HSLCAR:

- Common Channel Signaling 7 (CCS7)

Associated functionality codes

The functionality codes associated with OM group C7HSLCAR are shown in the following table.

Functionality	Code
TEL CCS7 Base	TEL00008

OM group C7HSLCAR (continued)

OM group C7HSLCAR registers: Far-end performance report message

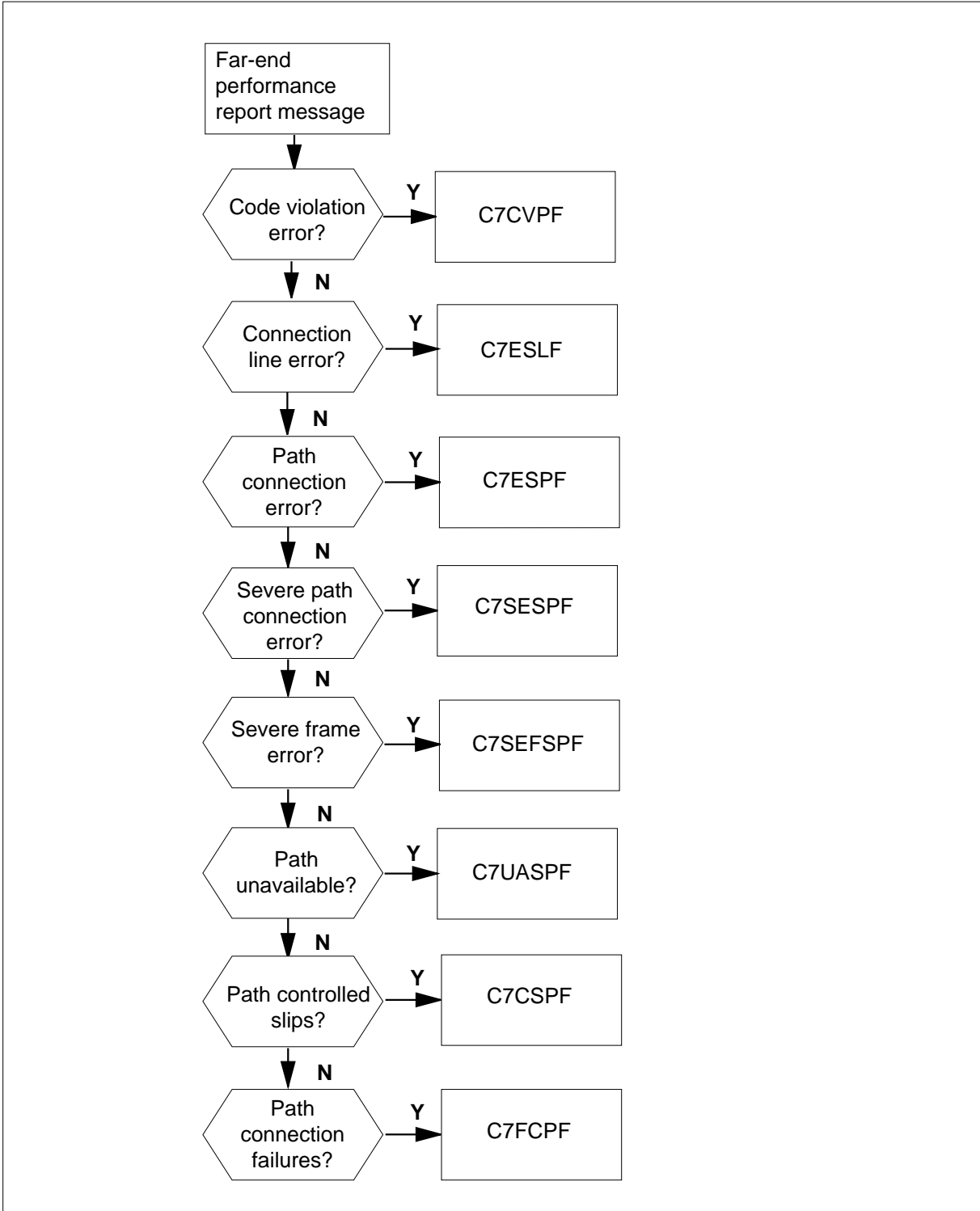

OM group C7HSLCAR (continued)

OM group C7HSLCAR registers: Local-end performance report message

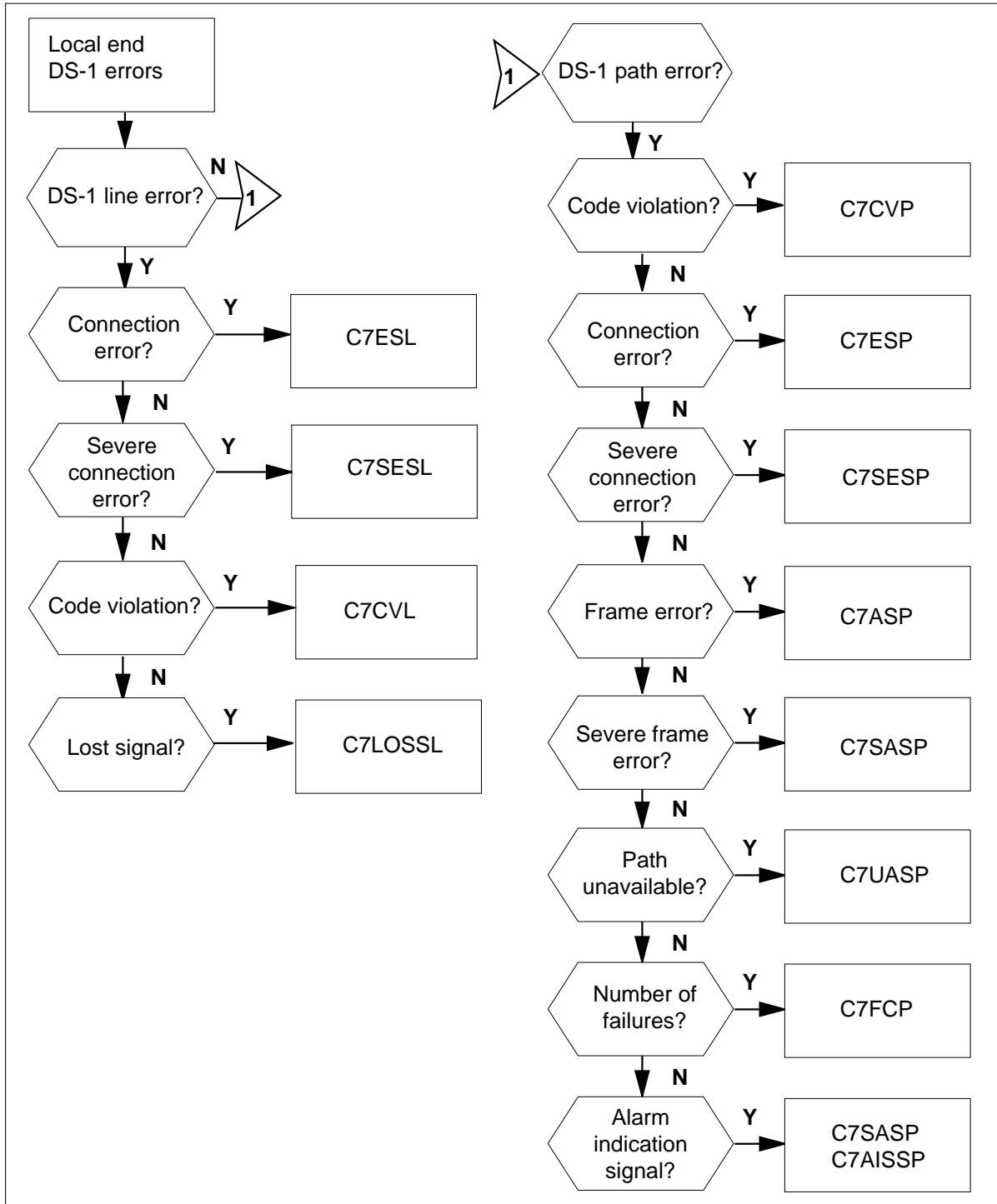

OM group C7HSLCAR (continued)

Register C7ESL

Errored Seconds—Line: ES-L

Register C7ESL counts the number of seconds one or more errors exist on the DS-1 line connection.

Register C7ESL release history

Register C7ESL was introduced in TL10.

Associated registers

None

Associated logs

None

Extension registers

None

Register C7CVL

Code Violations—Line: CV-L

Register C7CVL counts the number of code violations on the DS-1 line.

Register C7CVL release history

Register C7CVL was introduced in TL10.

Associated registers

None

Associated logs

None

Extension registers

None

Register C7SESL

Severely Errored Seconds—Line: SES-L

Register C7SESL counts the number of seconds a severe number of errors exist on the DS-1 line.

Register C7SESL release history

Register C7SESL was introduced in TL10.

OM group C7HSLCAR (continued)

Associated registers

None

Associated logs

None

Extension registers

None

Register C7LOSSL

Loss of Signal Seconds—Line: LOSS-L

Register C7LOSSL counts the number of seconds during which the signal is lost on the DS-1 line.

Register C7LOSSL release history

Register C7LOSSL was introduced in TL10.

Associated registers

None

Associated logs

None

Extension registers

None

Register C7CVP

Code Violations—Path: CV-P

Register C7CVP counts the number of code violations on the DS-1 path connection.

Register C7CVP release history

Register C7CVP was introduced in TL10.

Associated registers

None

Associated logs

None

OM group C7HSLCAR (continued)

Extension registers

None

Register C7ESP

Errored Seconds—Path: ES-P

Register C7ESP counts the number of seconds one or more errors exist on the DS-1 path connection.

Register C7ESP release history

Register C7ESP was introduced in TL10.

Associated registers

None

Associated logs

CCS125 provides information about high-speed link carriers if certain performance parameters are beyond threshold values.

Extension registers

None

Register C7SESP

Severely Errored Seconds—Path: SES-P

Register C7SESP counts the number of seconds that a severe number of errors exist on the DS-1 path connection.

Register C7SESP release history

Register C7SESP was introduced in TL10.

Associated registers

None

Associated logs

CCS125 provides information about a high-speed link carriers if certain performance parameters are beyond threshold values.

Extension registers

None

Register C7SASP

Severely Errored Frame/AIS Seconds—Path: SAS-P

OM group C7HSLCAR (continued)

Register C7SASP counts the number of seconds that a severe number of frame errors or alarm indication signals (AIS) exist on the DS-1 path connection.

Register C7SASP release history

Register C7SASP was introduced in TL10.

Associated registers

None

Associated logs

None

Extension registers

None

Register C7UASP

Unavailable Seconds—Path: UAS-P

Register C7UASP counts the number of seconds for which the link is not available for the traffic on the DS-1 path connection.

Register C7UASP release history

Register C7UASP was introduced in TL10.

Associated registers

None

Associated logs

CCS125 provides information about high-speed link carriers if certain performance parameters are beyond threshold values.

Extension registers

None

Register C7FCP

Failure Count—Path: FC-P

Register C7FCP counts the number of failures on the DS-1 path connection.

Register C7FCP release history

Register C7FCP was introduced in TL10.

OM group C7HSLCAR (continued)

Associated registers

None

Associated logs

None

Extension registers

None

Register C7AISSP

AIS Seconds—Path: AISS-P

Register C7AISSP counts the number of seconds an AIS exists on the DS-1 path connection.

Register C7AISSP release history

Register C7AISSP was introduced in TL10.

Associated registers

None

Associated logs

None

Extension registers

None

Register C7ESLF

Far-end Errored Seconds—Line: ES-LFE

Register C7ESLF counts the number of seconds one or more far-end errors exist on the DS-1 line.

Register C7ESLF release history

Register C7ESLF was introduced in TL10.

Associated registers

None

Associated logs

None

OM group C7HSLCAR (continued)

Extension registers

None

Register C7CVPF

Far-end Code Violations—Path: CV-PFE

Register C7CVPF counts the number of far-end code violations on the DS-1 path connection.

Register C7CVPF release history

Register C7CVPF was introduced in TL10.

Associated registers

None

Associated logs

None

Extension registers

None

Register C7ESPF

Far-end Errored Seconds—Path: ES-PFE

Register C7ESPF counts the number of seconds one or more far-end errors exist on the DS-1 path connection.

Register C7ESPF release history

Register C7ESPF was introduced in TL10.

Associated registers

None

Associated logs

CCS125 provides information about high-speed link carriers if certain performance parameters are beyond threshold values.

Extension registers

None

Register C7SESPF

Far-end Severely Errored Seconds—Path: SES-PFE

OM group C7HSLCAR (continued)

Register C7SESPF counts the number of seconds a severe number of far-end errors exist on the DS-1 path connection.

Register C7SESPF release history

Register C7SESPF was introduced in TL10.

Associated registers

None

Associated logs

CCS125 provides information about high-speed link carriers if certain performance parameters are beyond threshold values.

Extension registers

None

Register C7SEFSPF

Far-end Severely Errored Frame Seconds—Path: SEFS-PFE

Register C7SEFSPF counts the number of seconds that a severe number of far-end frame errors exist on the DS-1 path connection.

Register C7SEFSPF release history

Register C7SEFSPF was introduced in TL10.

Associated registers

None

Associated logs

None

Extension registers

None

Register C7UASPF

Far-end Unavailable Seconds—Path: UAS-PFE

Register C7UASPF counts the number of seconds in which the far-end link is not available for the traffic on the DS-1 path connection.

Register C7UASPF release history

Register C7UASPF was introduced in TL10.

OM group C7HSLCAR (continued)

Associated registers

None

Associated logs

CCS125 provides information about high-speed link carriers if certain performance parameters are beyond threshold values.

Extension registers

None

Register C7CSPF

Far-end Controlled Slips—Path: CS-PFE

Register C7CSPF counts the number of far-end controlled slips on the DS-1 path connection.

Register C7CSPF release history

Register C7CSPF was introduced in TL10.

Associated registers

None

Associated logs

CCS125 provides information about high-speed link carriers if certain performance parameters are beyond threshold values.

Extension registers

None

Register C7FCPF

Far-end Failure Count—Path: FC-PFE

Register C7FCPF counts the number of far-end failures on the DS-1 path connection.

Register C7FCPF release history

Register C7FCPF was introduced in TL10.

Associated registers

None

Associated logs

None

OM group C7HSLCAR (end)

Extension registers

None

OM group C7LINK1

OM description

CCS7 link group 1 (C7LINK1)

The OM group CCS7 link group 1 (C7LINK1) provides information on the failures and recoveries of a Common Channel Signaling 7 (CCS7) link. A CCS7 link is a communication path that moves voice or signaling messages between two signaling points in a CCS7 network.

Links must be synchronized or aligned to move messages between signaling points. The system checks for links that are available and that links, signaling terminals, and network connections are allocated where appropriate.

When a link is synchronized, the system or operating company personnel at signaling point offices, can manipulate the link. The system or operating company personnel can inhibit links or reroute messages to other lines. Message traffic determines the action.

Errors, like negative message acknowledgements from the far-end signaling point, signal unit errors, and congestion can occur on a link. The system transmits some errors again and attempts to recover from other errors. If many errors occur, the link becomes unsynchronized. This condition causes an alarm to occur in the office. The alarm must be acted upon immediately, unless otherwise indicated.

The C7LINK1 group counts link synchronization errors and link failure recoveries. When a recovery is possible, the link completes message transmission.

Release history

The OM group C7LINK1 was introduced in BCS20.

TL07

The Ethernet link interface unit (ELIU) was added to the nodes that increase the registers in OM group C7LINK1.

TL04

Register C7CLB was introduced and activated.

BCS33

You can convert registers C7LKSYNU and C7LKUNAU from CCS to deci-erlangs before these registers appear. Use the OMSHOW command on the ACTIVE class to convert these registers.

OM group C7LINK1 (continued)

BCS32

Register C7ERRSEC was introduced to report the length of time the system detected one or more in-service errors on a signaling link.

BCS30

Software changes provide usage counts either in CCS or in deci-erlangs.

BCS29

Register C7AUTOCO was introduced to count automatic changeovers away from the link.

Registers

The OM group C7LINK1 registers appear on the MAP terminal as follows.

C7LKSYN	C7LKFAIL	C7ABNRFB	C7EXDLAY
C7EXERR	C7EXCONG	C7ALIGNF	C7SUERR
C7NACKRX	C7STALFL	C7TLALFL	C7NETCON
C7SLTFL	C7NUCFL	C7COV	C7CBK
C7LKUNAU	C7MANB	C7BSYON	C7BSYOFF
C7LINH	C7LUNINH	C7RINH	C7RUNINH
C7LPO	C7RPO	C7AUTOCO	C7ERRSEC
C7CLB			

Group structure

The OM group C7LINK1 provides one tuple for each key.

Key field:

C7_LINKSET_NUMBER Number in the range 0 to 254, used as an index into table C7LKSET.

Info field:

C7LINK_OMINFO The information field has a two-part key: CLLI and C7_Sig Link_Code. The common language location identifier (CLLI) is the linkset CLLI of the linkset that owns the link. The CCS7 signaling link code is a number from 0 to 15 that identifies the specific link in the linkset.

Office parameter C7_SLMPR_ALARM_ON in table OFCVAR indicates when a link exceeds a threshold value, a minor alarm occurs.

A link minor alarm occurs and the link goes in-service trouble, with the following:

- the value of the office parameter is TRUE
- a link exceeds the threshold value

OM group C7LINK1 (continued)

Associated OM groups

The OM group C7LINK2 provides information on calls and congestion for a CCS7 link.

The OM group C7LINK3 monitors traffic and performance of message signal units on a CCS7 link.

In the OM group C7LINK3, register C7CLBU contains the duration of the controlled link blocking (CLB). Register C7CLB increases the CLB in OM group C7LINK1.

Associated functional groups

There are no associated functional groups.

Associated functionality codes

The functionality codes associated with OM group C7LINK1 appear in the following table.

Functionality	Code
Remote Line Module (RLM)	NTX023AB
STP Operations	NTX833AA

OM group C7LINK1 (continued)

OM group C7LINK1 registers: no inhibit

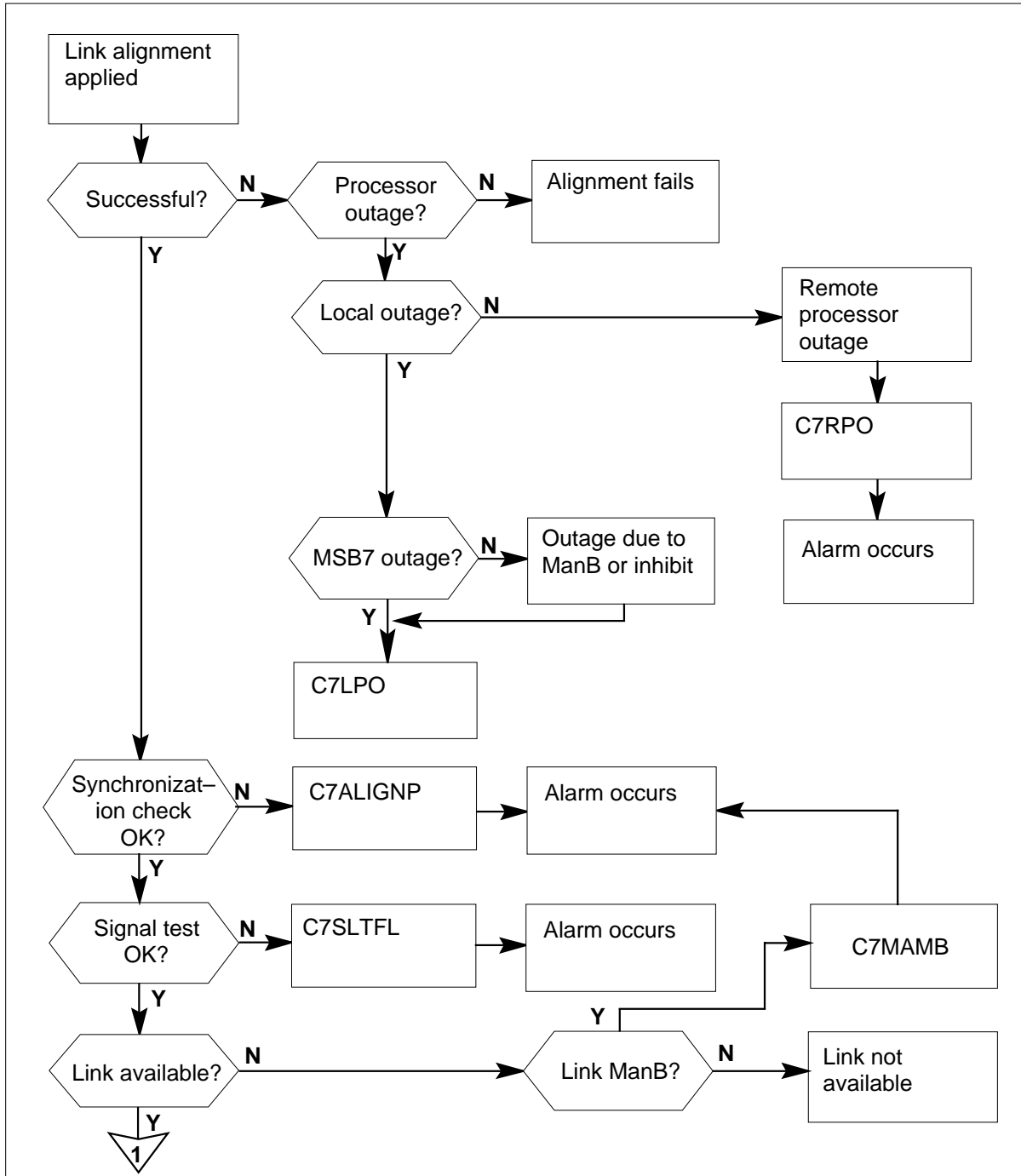

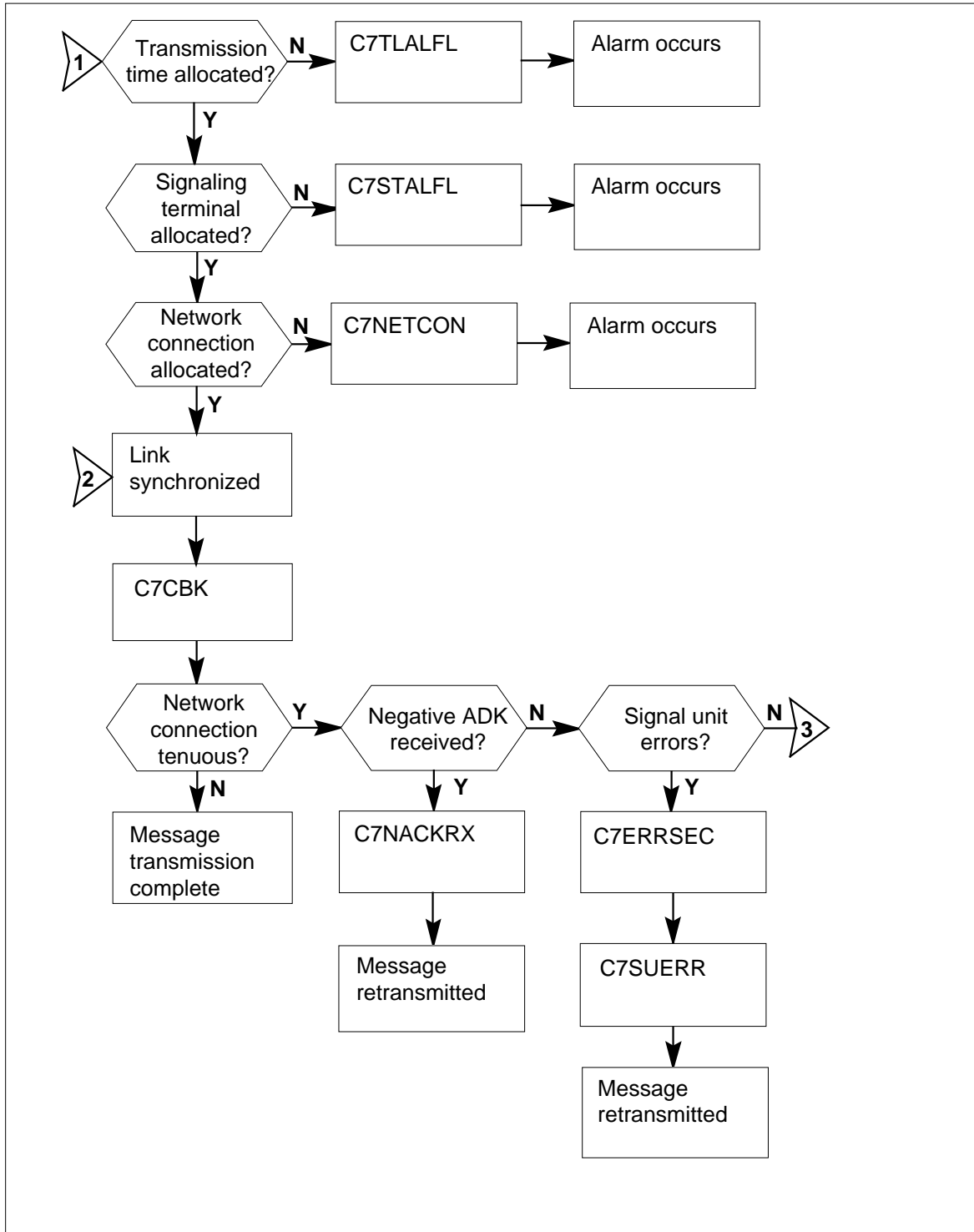
OM group C7LINK1 (continued)**OM group C7LINK1 registers: no inhibit (continued)**

OM group C7LINK1 (continued)

OM group C7LINK1 registers: no inhibit (continued)

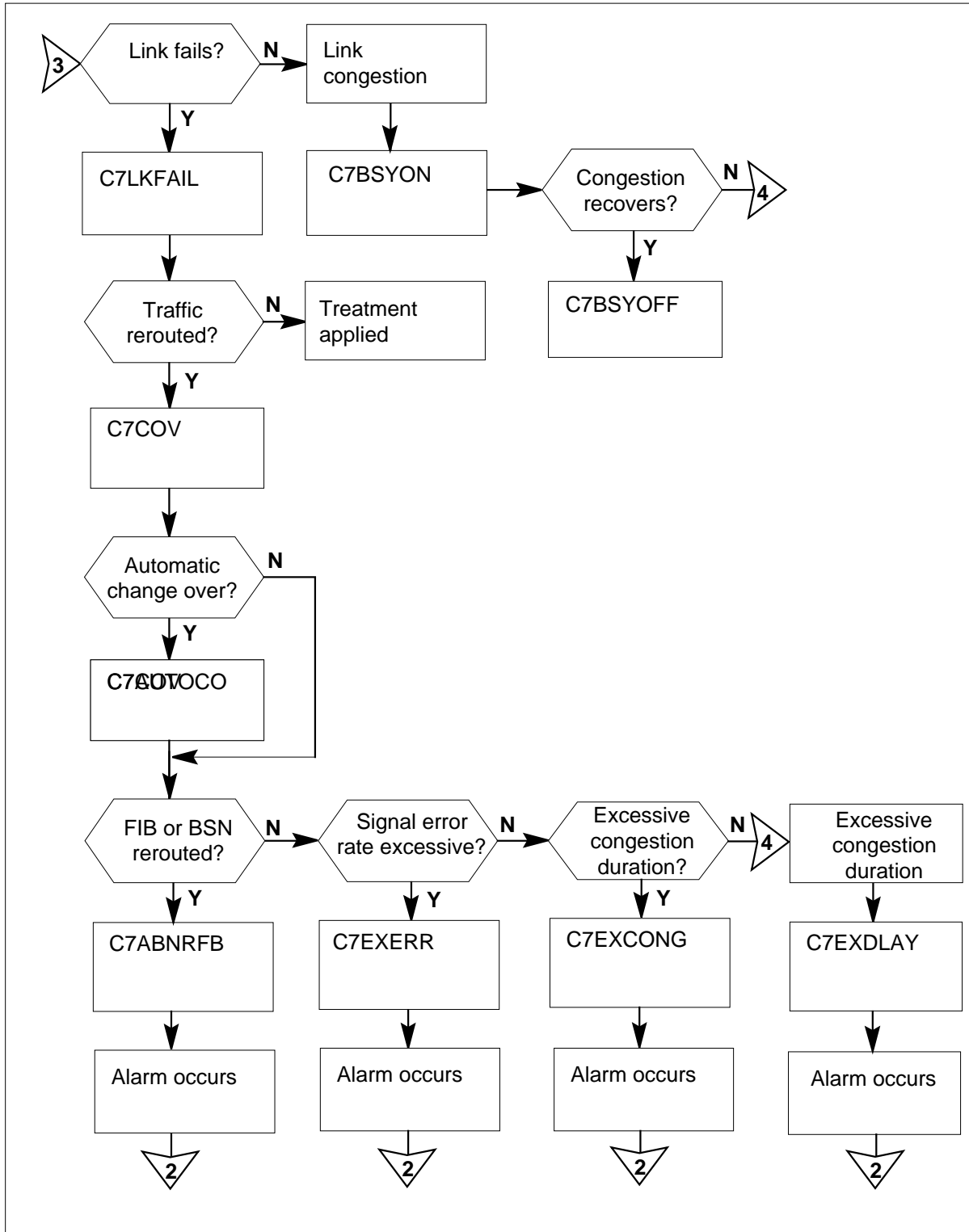

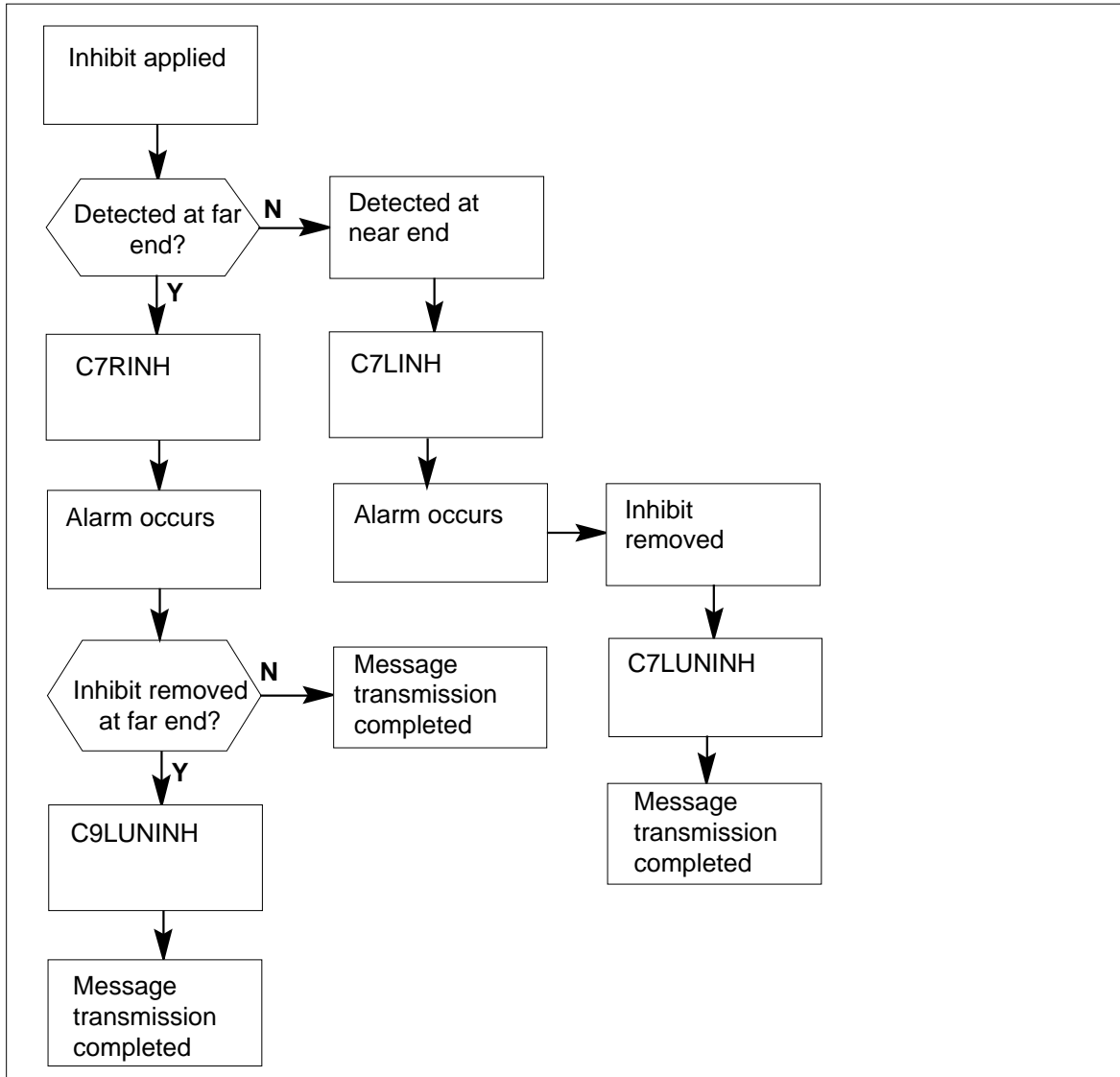
OM group C7LINK1 (continued)**OM group C7LINK1 registers: inhibit applied**

OM group C7LINK1 (continued)

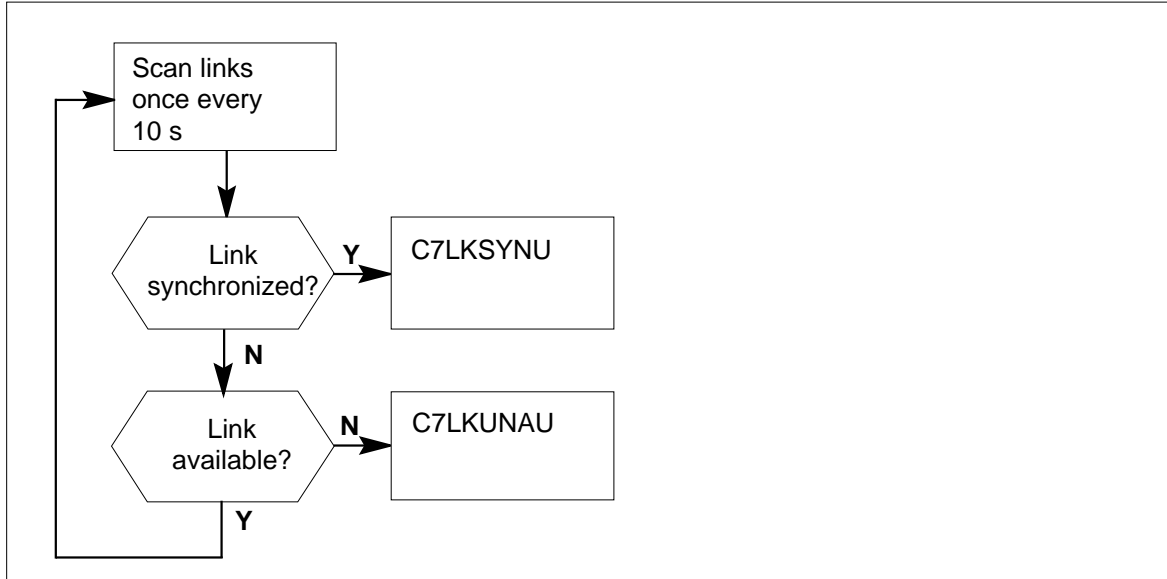
OM group C7LINK1 registers: usage registers**Register C7ABNRFB**

CCS7 abnormal forward indicator bit Rx or backward sequence number Rx (C7ABNRFB)

Register (C7ABNRFB) counts CCS7 link synchronization failures. Abnormal forward indicator bits (FIB) or backward sequence numbers (BSN) that the signaling terminal (ST) receives cause the failures. When link synchronization fails, an alarm occurs.

This register increases in the central control (CC).

Register C7ABNRFB release history

Register C7ABNRFB was introduced in BCS20.

Associated registers

Register C7ABNRFB counts CCS7 link synchronizations that fail because of abnormal FIBs. Link synchronizations can also fail because the ST receives an abnormal BSN that is abnormal.

Register C7EXCONG counts CCS7 link synchronizations that fail because of prolonged congestion on the link.

Register C7EXDLAY counts CCS7 link synchronizations that fail because the far-end ST delays the acknowledgement of messages that were sent.

OM group C7LINK1 (continued)

Register C7EXERR counts CCS7 link synchronizations that fail because the ST detects excessive signal unit errors.

Register C7LKFAIL counts CCS7 link synchronization failures.

C7LINK1_C7ABNRFB + C7LINK1_C7EXDLAY + C7LINK1_C7EXERR
+ C7LINK1_C7EXCONG & C7LINK1_C7LKFAIL

Associated logs

The system generates log CCS101 when synchronization fails.

Extension registers

There are no extension registers.

Register C7ALIGNF

CCS7 alignment failure (C7ALIGNF)

Register C7ALIGNF counts CCS7 link synchronization failures. The failures occur during the alignment or proving period when the system checks links for synchronization.

The signaling link cannot synchronize because of this failure. An alarm continues.

This register increases in the central control (CC).

Register C7ALIGNF release history

Register C7ALIGNF was introduced in BCS20.

Associated registers

There are no associated registers.

Associated logs

There are no associated logs.

Extension registers

There are no extension registers.

Register C7AUTOCO

CCS7 automatic changeovers (C7AUTOCO)

OM group C7LINK1 (continued)

Register C7AUTOCO counts CCS7 automatic changeovers (traffic reroutes) away from the link. An automatic changeover is a changeover that operating company personnel does not initiate.

A changeover indicates that traffic was diverted away from a common channel signaling link.

Register C7AUTOCO release history

Register C7AUTOCO was introduced in BCS29.

Associated registers

There are no associated registers.

Associated logs

There are no associated logs.

Extension registers

There are no extension registers.

Register C7BSYOFF

CCS7 busy off (C7BSYOFF)

Register C7BSYOFF increases in the signaling terminal (ST). The system transfers the register to the central control (CC) during the OM transfer process.

Register C7BSYOFF counts the busy signal transmission stops at the ST. A busy signal transmission stop indicates that the link recovered from congestion.

Register C7BSYOFF release history

Register C7BSYOFF was introduced in BCS20.

Associated registers

There are no associated registers.

Associated logs

There are no associated logs.

Extension registers

There are no extension registers.

OM group C7LINK1 (continued)

Register C7BSYON

CCS7 busy on (C7BSYON)

Register C7BSYON counts the busy signal transmission starts at the ST. A busy signal transmission start indicates congestion on the link that can cause a link failure.

This register increases in the ST. The system transfers the register to the central control (CC) during the OM transfer process.

Register C7BSYON release history

Register C7BSYON was introduced in BCS20.

Associated registers

There are no associated registers.

Associated logs

There are no associated logs.

Extension registers

There are no extension registers.

Register C7CBK

CCS7 changeback (C7CBK)

Register C7CBK counts changebacks on the link. A changeback is traffic that the system reroutes and returns to the link. Changebacks indicate an improvement in common channel signaling conditions.

This register increases in the central control (CC).

Register C7CBK release history

Register C7CBK was introduced in BCS20.

Associated registers

There are no associated registers.

Associated logs

The system generates log CCS163 when register C7CBK increases. This action does not occur when system stopped the changeback to perform a changeover and make the link not available. Log CCS163 indicates that a CCS7 link became available for signaling traffic and that traffic runs on the link.

OM group C7LINK1 (continued)

Extension registers

There are no extension registers.

Register C7COV

CCS7 changeover (C7COV)

Register C7COV counts changeovers (traffic reroutes) away from the link.

A changeover indicates that the system diverted traffic away from a common channel signaling link. An alarm occurs.

Register C7COV release history

Register C7COV was introduced in BCS20.

Associated registers

There are no associated registers.

Associated logs

The system generates CCS164 when a link is not available.

Extension registers

There are no extension registers.

Register C7ERRSEC

CCS7 link errored seconds (C7ERRSEC)

Register C7ERRSEC reports the length of time the system detects a minimum of one in-service error on a signaling link.

Register C7ERRSEC release history

Register C7ERRSEC was introduced in BCS32.

Associated registers

C7SUERR

Associated logs

There are no associated logs.

Extension registers

There are no extension registers.

Register C7EXCONG

CCS7 excessive congestion (C7EXCONG)

OM group C7LINK1 (continued)

Register C7EXCONG counts CCS7 link synchronizations that fail because of prolonged congestion on the link.

Link synchronization failure causes an alarm to occur. This register increases in the central control (CC).

Register C7EXCONG release history

Register C7EXCONG was introduced in BCS20.

Associated registers

Register C7ABNRFB counts CCS7 link synchronizations that fail because of abnormal forward indicator bits (FIB). This register also counts CCS7 link synchronizations that fail because an abnormal backward sequence number (BSN) that the ST receives.

Register C7EXDLAY counts CCS7 link synchronizations that fail because the far-end ST delays the acknowledgement of messages that were sent.

Register C7EXERR counts CCS7 link synchronizations that fail because the ST detects excessive signal unit errors.

Register C7LKFAIL counts CCS7 link synchronization failures.

$C7LINK1_C7ABNRFB + C7LINK1_C7EXDLAY + C7LINK1_C7EXERR + C7LINK1_C7EXCONG \leq C7LINK1_C7LKFAIL$

Associated logs

The system generates CCS101 when synchronization fails.

Extension registers

There are no extension registers.

Register C7EXDLAY

CCS7 excessive delay (C7EXDLAY)

Register C7EXDLAY counts CCS7 link synchronizations that fail. This event occurs because the far-end ST delays the acknowledgement of messages that were sent.

Link synchronization failure raises an alarm.

This register increases in the central control (CC).

OM group C7LINK1 (continued)

Register C7EXDLAY release history

Register C7EXDLAY was introduced in BCS20.

Associated registers

Register C7ABNRFB counts CCS7 link synchronizations that fail because of abnormal forward indicator bits (FIB). This register also counts CCS7 link synchronizations that fail because of abnormal backward sequence number (BSN) that the ST receives.

Register C7EXCONG counts CCS7 link synchronizations that fail because of prolonged congestion on the link.

Register C7EXERR counts CCS7 link synchronizations that fail because the ST detects excessive signal unit errors.

Register C7LKFAIL counts CCS7 link synchronization failures.

$$C7LINK1_C7ABNRFB + C7LINK1_C7EXDLAY + C7LINK1_C7EXERR + C7LINK1_C7EXCONG \leq C7LINK1_C7LKFAIL$$

Associated logs

The system generates CCS101 when synchronization fails.

Extension registers

There are no extension registers.

Register C7EXERR

CCS7 excessive error rate (C7EXERR)

Register C7EXERR counts CCS7 link synchronizations that fail because the ST detects excessive signal unit errors.

Link synchronization failure raises an alarm.

This register increases in the central control (CC).

Register C7EXERR release history

Register C7EXERR was introduced in BCS20.

Associated registers

Register C7ABNRFB counts CCS7 link synchronizations that fail because of abnormal forward indicator bits (FIB). These synchronizations can also fail because of abnormal backward sequence numbers (BSN) that the ST receives.

OM group C7LINK1 (continued)

Register C7EXCONG counts CCS7 link synchronizations that fail because of prolonged congestion on the link.

Register C7EXDLAY counts CCS7 link synchronizations that fail because the far-end ST delays the acknowledgement of messages that were sent.

Register C7LKFAIL counts CCS7 link synchronization failures.

C7LINK1_C7ABNRFB + C7LINK1_C7EXDLAY + C7LINK1_C7EXERR
+ C7LINK1_C7EXCONG £ C7LINK1_C7LKFAIL

Associated logs

The system generates CCS101 when synchronization fails.

Extension registers

There are no extension registers.

Register C7LINH

CCS7 local inhibit (C7LINH)

Register C7LINH increases when local inhibit is applied to the link. Local inhibit means that operating company personnel divert traffic away from the link with the use of the inhibit procedure.

Application of local inhibit raises an alarm.

This register increases in the central control (CC).

Register C7LINH release history

Register C7LINH was introduced in BCS20.

Associated registers

Register C7LUNINH increases when local inhibiting state is removed from the link.

Register C7LINK1_C7LINH = C7LINK1_C7LUNINH when the link does not have an inhibit indication.

Associated logs

The system generates log CCS159 when a CCS7 link is inhibited locally, as requested by the operating company personnel.

Extension registers

There are no extension registers.

OM group C7LINK1 (continued)

Register C7LKFAIL

CCS7 link failure (C7LKFAIL)

Register CCS7 link failure (C7LKFAIL) counts CCS7 link synchronization failures. This register counts in-service link failures. This register does not count link activation failures (link not in-service failures).

Link synchronization failure raises an alarm.

This register increases in the central control (CC).

Register C7LKFAIL release history

C7LKFAIL was introduced in BCS20.

Associated registers

Register C7ABNRFB counts CCS7 link synchronizations that fail because of abnormal forward indicator bits (FIB). This register also counts CCS7 link synchronizations that fail because of an abnormal backward sequence number (BSN) that the ST receives.

Register C7EXCONG counts CCS7 link synchronizations that fail because of prolonged congestion on the link.

Register C7EXDLAY counts CCS7 link synchronizations that fail because the far-end ST delays the acknowledgement of messages that were sent.

Register C7EXERR counts CCS7 link synchronizations that fail because the ST detects excessive signal unit errors.

$$C7LINK1_C7ABNRFB + C7LINK1_C7EXDLAY + C7LINK1_C7EXERR + C7LINK1_C7EXCONG \leq C7LINK1_C7LKFAIL$$

Any difference represents link failures that occur as a result of other causes.

Associated logs

The system generates log CCS101 when synchronization fails.

Extension registers

There are no extension registers.

Register C7LKSYNU

CCS7 link synchronization (C7LKSYNU)

OM group C7LINK1 (continued)

Register C7LKSYNNU is a usage register. The scan rate is 10 s. This register records if a CCS7 link is synchronized and able to carry signaling units to the far-end ST.

If this register does not increase every 10 s, the link failed. When the link fails an alarm occurs. This action does not indicate that the link is for traffic.

This register increases in the central control (CC).

Register C7LKSYNNU release history

Register C7LKSYNNU was introduced in BCS20.

BCS33

When the office parameter OMINERLANGS is set to Y, the usage count is converted from CCS to deci-erlangs. This action occurs before the usage count appears. The OMSHOW command on the ACTIVE class converts the usage count from CCS to deci-erlangs. The value in the active registers does not alter and remains in CCS.

BCS30

Software changes provide usage counts in CCS or deci-erlangs.

Associated registers

There are no associated registers.

Associated logs

The system generates log CCS101 when synchronization fails.

The system generates log CCS102 when synchronization occurs.

Extension registers

There are no extension registers.

Register C7LKUNAU

CCS7 link unavailable (C7LKUNAU)

Register CCS7 link unavailable (C7LKUNAU) is a usage register. The scan rate is 10 s. This register records if a link is not available for traffic.

Register C7LKUNAU release history

Register C7LKUNAU was introduced in BCS20.

OM group C7LINK1 (continued)

BCS33

When the office parameter OMINERLANGS is set to Y, the usage count is converted from CCS to deci-erlangs. This action occurs before the count appears. The OMSHOW command on the ACTIVE class converts the usage count from CCS to deci-erlangs. The value held in the active registers does not alter and remains in CCS.

BCS30

Software changes provide usage counts in CCS or deci-erlangs.

Associated registers

There are no associated registers.

Associated logs

The system generates log CCS163 when a link is available.

The system generates log CCS164 when a link is not available.

Extension registers

There are no extension registers.

Register C7LPO

CCS7 local processor outage (C7LPO)

Register CCS7 local processor outage (C7LPO) counts local processor outages (LPO) that the ST detects.

The register controls the following events:

- the message switch and buffer (MSB7) outages
- events during which the local processor is manual busy (the link is taken out of service manually)
- events during which inhibit procedures control a link

If an MSB7 outage caused the LPO, a serious problem occurred. If manual busy or inhibit procedures caused the LPO, an alarm will occur.

This register increases in the ST and transfers to the central control (CC) during the OM transfer process.

Register C7LPO release history

Register C7LPO was introduced in BCS20.

OM group C7LINK1 (continued)

Associated registers

There are no associated registers.

Associated logs

The system generates log PM102 when a system request changes a peripheral module (PM) to system busy.

The system generates log PM105 when a manual request changes a PM to manual busy.

Extension registers

There are no extension registers.

Register C7LUNINH

CCS7 local uninhibit (C7LUNINH)

Register C7LUNINH increases when local inhibiting status is removed from the link.

The link can serve traffic if all other controls and problems can be serviced.

This register increases in the central control (CC).

Register C7LUNINH release history

Register C7LUNINH was introduced in BCS20.

Associated registers

Register C7LINH increases when local inhibit is applied to the link.

When the link does not have an inhibit indication, $C7LINK1_C7LUNINH = C7LINK1_C7LINH$.

Associated logs

The system generates log CCS161 when operating company personnel remove the local inhibit on a CCS7 link.

Extension registers

There are no extension registers.

Register C7MANB

CCS7 manual busy (C7MANB)

Register C7MANB increases when the link is manual busy.

OM group C7LINK1 (continued)

Manual busy indicates that operating company personnel control a link. An alarm can occur.

This register increases in the central control (CC).

Register C7MANB release history

Register C7MANB was introduced in BCS20.

Associated registers

There are no associated registers.

Associated logs

The system generates logs CCS157 when a CCS link is manual busy.

Extension registers

There are no extension registers.

Register C7NACKRX

CCS7 negative acknowledgements (C7NACKRX)

Register C7NACKRX counts negative acknowledgements received from the far-end signaling terminal (ST). Negative acknowledgement indicates that messages are not correctly received. The messages are transmitted again.

This register increases in the ST and transfers to the central control (CC) during the OM transfer process.

Register C7NACKRX release history

Register C7NACKRX was introduced in BCS20.

Associated registers

There are no associated registers.

Associated logs

There are no associated logs.

Extension registers

There are no extension registers.

Register C7NETCON

CCS7 network connection (C7NETCON)

OM group C7LINK1 (continued)

Register C7NETCON increases when link synchronization fails. Link synchronization fails because of failure to connect with the network. An alarm occurs.

This register increases in the central control (CC).

Register C7NETCON release history

Register C7NETCON was introduced in BCS20.

Associated registers

There are no associated registers.

Associated logs

There are no associated logs.

Extension registers

There are no extension registers.

Register C7NUCFL

CCS7 nail-up connection failure (C7NUCFL)

Register C7NUCFL increases when link activation cannot establish a permanent network connection.

A synchronized link that does not have a permanent network connection cannot survive a central control (CC) restart. The link continues to operate and service is not affected.

This register increases in the CC.

Register C7NUCFL release history

Register C7NUCFL was introduced in BCS20.

Associated registers

There are no associated registers.

Associated logs

The system generates CCS108 when a CCS7 link reaches synchronization but cannot reserve the link.

Extension registers

There are no extension registers.

OM group C7LINK1 (continued)

Register C7RINH

Register CCS7 remote inhibit

Register C7RINH increases when operating company personnel apply remote inhibit to the link in order to divert traffic away from the link. An alarm occurs in the CCS7 system.

This register increases in the central control (CC).

Register C7RINH release history

Register C7RINH was introduced in BCS20.

Associated registers

Register C7RUNINH increases when remote inhibiting is removed from a link.

When link does not have an inhibit indication, C7LINK1_C7RINH = C7LINK1_C7RUNINH.

Associated logs

The system generates CCS160 when a CCS link is remote inhibited, as requested by the far-end office.

Extension registers

There are no extension registers.

Register C7RPO

CCS7 remote processor outages (C7RPO)

Register C7RPO counts remote processor outages ST reports.

Remote processor outages indicate that the link is not able to deliver traffic. An alarm occurs. The local office must wait for the far-end signaling point to recover.

This register increases in the central control (CC).

Register C7RPO release history

Register C7RPO was introduced in BCS20.

Associated registers

There are no associated registers.

OM group C7LINK1 (continued)

Associated logs

The system generates CCS104 RPO when the far end of a CCS link has a processor outage.

Extension registers

There are no extension registers.

Register C7RUNINH

CCS7 remote uninhibit (C7RUNINH)

Register C7RUNINH increases when remote inhibiting is removed from a link. If other controls or problems are not present on the link, the link can be used.

Register C7RUNINH release history

Register C7RUNINH was introduced in BCS20.

Associated registers

Register C7RINH increases when operating company personnel apply the remote inhibit to the link.

When the link does not have other inhibit indicators, C7LINK1_C7RINH = C7LINK1_C7RUNINH.

Associated logs

The system generates log CCS162 when a CCS link is remote uninhibited by the far end.

Extension registers

There are no extension registers.

Register C7SLTFL

CCS7 signaling link test failure (C7SLTFL)

Register C7SLTFL increases when signaling cannot take place because of a signaling link test (SLT) failure.

An SLT failure indicates that the system cannot synchronize a link. An alarm occurs in the CCS7 system.

This register increases in the central control (CC).

OM group C7LINK1 (continued)

Register C7SLTFL release history

Register C7SLTFL was introduced in BCS20.

Associated registers

There are no associated registers.

Associated logs

The system generates log CCS101 when synchronization fails.

The system generates log CCS107 if the SLT fails during the initial activation procedure.

Extension registers

There are no extension registers.

Register C7STALFL

CCS7 signaling terminal allocation failure (C7STALFL)

Register C7STALFL increases when signaling cannot take place because the ST cannot be allocated.

The system cannot synchronize a link. An alarm occurs in the CCS7 system.

This register increases in the central control (CC).

Register C7STALFL release history

Register C7STALFL was introduced in BCS20.

Associated registers

There are no associated registers.

Associated logs

There are no associated logs.

Extension registers

There are no extension registers.

Register C7SUERR

CCS7 signal units error (C7SUERR)

Register C7SUERR counts signal units on a link received in error. The count in this register is the number of messages that are not received correctly from the far-end signaling point. The messages are transmitted.

OM group C7LINK1 (continued)

This register increases in the signaling terminal and transferred to the central control (CC) during the OM transfer process.

Register C7SUERR release history

Register C7SUERR was introduced in BCS20.

Associated registers

C7ERRSEC

Associated logs

There are no associated logs.

Extension registers

There are no extension registers.

Register C7TLALFL

CCS7 transmission link allocation failure (C7TLALFL)

Register C7TLALFL increases when signaling cannot take place. Signaling cannot take place because a transmission link cannot be allocated.

The system cannot synchronize a link. An alarm occurs.

This register increases in the central control (CC).

Register C7TLALFL release history

Register C7TLALFL was introduced in BCS20.

Associated registers

There are no associated registers.

Associated logs

There are no associated logs.

Extension registers

There are no extension registers.

Register C7CLB

Number of times that controlled link blocking (CLB) was applied to the link during an OM period.

Register C7CLB release history

Register C7CLB was introduced CSP04.

OM group C7LINK1 (end)

Associated registers

Register *C7CLB* in the *C7LINK1* group stores the period of time that *CLB* was applied to the link during the last *OM* period.

Associated logs

The system generates log *CCS193* when the last router is out of service. When the system generates *CCS193*, the *CCS7* links are in a *CLB* state that will increase this *OM*.

OM group C7LINK2

OM description

CCS7 link group 2 (C7LINK2)

The OM group C7LINK2 provides information on calls and congestion for Common Channel Signaling 7 (CCS7). A CCS7 link is a communication path. This path moves voice or signaling messages between two signaling transfer points (STP) in a CCS7 network system.

This register counts the following types of congestion that impede the flow of signaling messages on a link:

- link congestion detected in the link-handling peripheral. A link-handling peripheral is a message switch and buffer (MSB), a CCS7 link interface unit (LIU7) or a high-speed link interface unit (HLIU).
- transmission buffer congestion detected in the signaling terminals

The system measures link congestion against three set thresholds. The user part gives messages a priority from zero to three. The system compares the priority threshold to the congestion threshold to determine if it should send the message. The system transmits messages with priorities equal to or greater than the congestion threshold. The system discards other messages.

The system measures transmission buffer congestion against three thresholds that are set to determine the onset of congestion in the buffer. The system also measures the three thresholds set to determine the abatement of congestion. An overflow threshold and corresponding abatement threshold also exist.

The LIU7 or HLIU handles all functions that the CCS7 must perform for each link. Registers count the following:

- messages that are lost or not sequenced correctly
- messages that originate and terminate at the signal transfer point
- messages that are passed on to other signaling transfer points

The following registers reside in the signaling terminal (ST):

- register C7BYTRT
- register C7BYTRTX
- register C7BYTRX
- register C7BYTRX2
- register C7BYTTX
- register C7BYTTX2

OM group C7LINK2 (continued)

- register C7MSURX
- register C7MSURX2
- register C7MSUTX
- register C7MSUTX2
- register C7MSUDSC

Register C7STRET increases when the information that these registers collect is transferred to a holding register in the central control (CC). Registers C7MSUDC1, C7MSUDC2, and C7MSUDC3 reside in the link-handling peripheral module. Register C7MSBRET increases when the information that these registers collect is transferred to a holding register in the CC.

Release history

OM group C7LINK2 was introduced in BCS20. Registers C7ONSET1, C7ONSET2, C7ONSET3, C7ABATE1, C7ABATE2, C7ABATE3, C7MSUDC1, and C7MSUDC2 were set to zero.

TL11

Added HLIU information.

TL07

The Ethernet link interface unit (ELIU) was added to the nodes that can increase the registers in OM group C7LINK2.

BCS25

The following registers were added:

- register C7MSGLOS
- register C7MSGMSQ
- register C7MSUTE
- register C7MSUTE2
- register C7MSUTS
- register C7MSUTS2

The listed registers were set to zero for all except CCS7 STP products based on the LIU7.

BCS21

Registers C7ONSETV, C7ABATEV, C7STRET, and C7SMBRET were added. Registers C7MSUOR and C7MSUOR2 were added and set to zero for

OM group C7LINK2 (continued)

all but CCS7 STP products based on the LIU7. Registers C7ONSET1, C7ONSET2, C7ONSET3, C7ABATE1, C7ABATE2, C7ABATE3, C7MSUDC1, C7MSUDC2, and C7MSUDC3 were activated.

Registers

OM group C7LINK2 registers appear on the MAP terminal as follows.

C7MSUTX	C7MSUTX2	C7MSURX	C7MSURX2
C7BYTTX	C7BYTTX2	C7BYTRX	C7BYTRX2
C7BYTRT	C7BYTRT2	C7MSUDSC	C7ONSET1
C7ONSET2	C7ONSET3	C7ONSETV	C7ABATE1
C7ABATE2	C7ABATE3	C7ABATEV	C7MSUDC1
C7MSUDC2	C7MSUDC3	C7STRET	C7MSBRET
C7MSGLOS	C7MSGMSQ	C7MSUOR	C7MSUOR2
C7MSUTE	C7MSUTE2	C7MSUTS	C7MSUTS2

Group structure

OM group C7LINK2 provides one tuple for each key.

Key field:

C7_LINKSET_NUMBER is a number in the range 0 to 254, used as an index into table C7LKSET.

Info field:

C7LINK_OMINFO

The information field has a two-part key named CLLI, C7_Sig_Link_Code.

The CLLI is the linkset common language location identifier (CLLI) of the linkset that owns the link. The CCS7 signaling link code is a number from 0 to 15 that identifies an exact link in a linkset.

Associated OM groups

Register C7LINK1 counts failures and recoveries of a CCS7 link.

Associated functional groups

There are no associated functional groups.

OM group C7LINK2 (continued)

Associated functionality codes

The associated functionality codes for OM group C7LINK2 appear in the following table.

Functionality	Code
Remote Line Module	NTX023AB
CC7-MTP Associated and Non-associated Signaling	NTX041AA
CC7-MTP Associated and Non-associated Signaling	NTX041AB

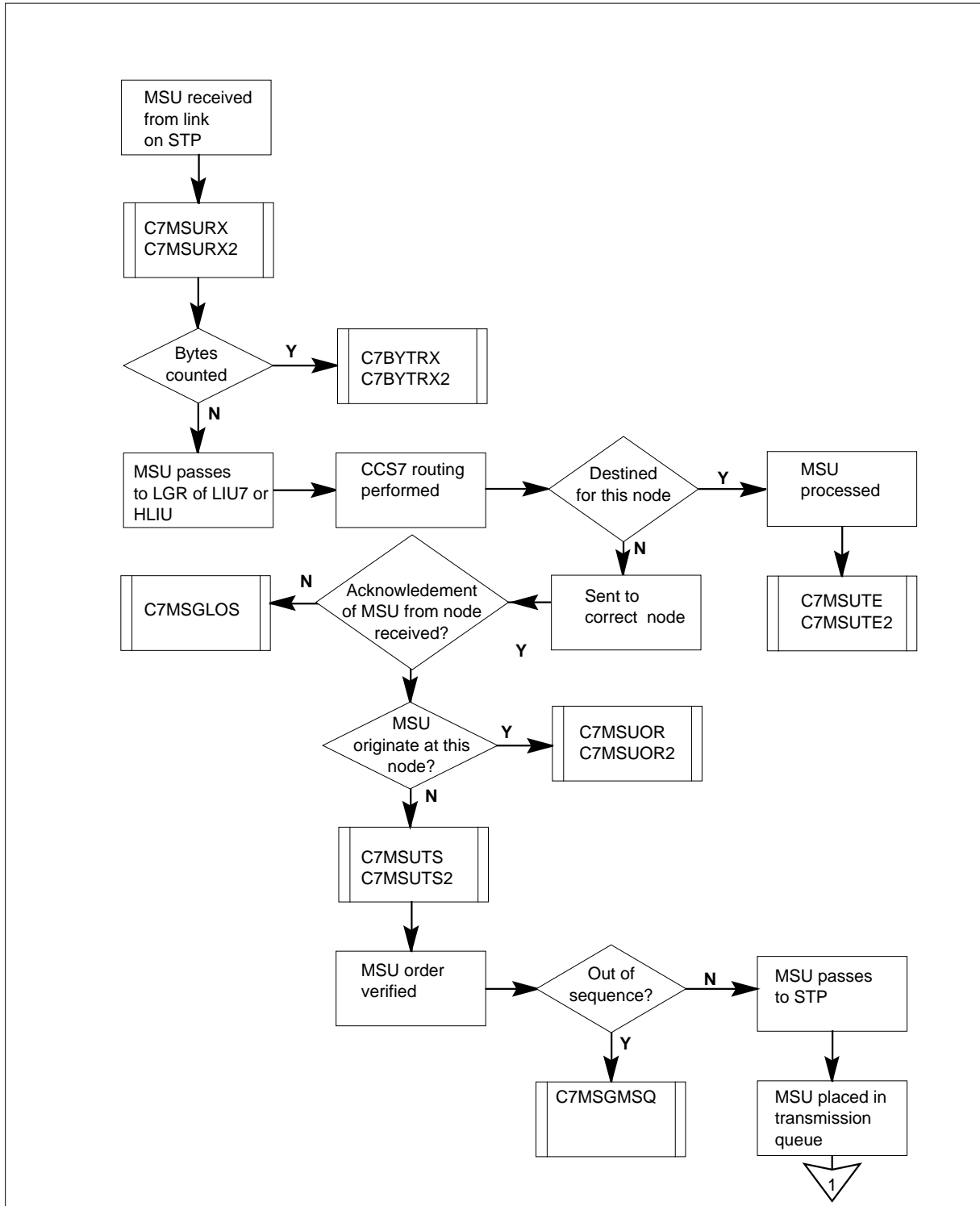
OM group C7LINK2 (continued)**OM group C7LINK2 registers**

OM group C7LINK2 (continued)

OM group C7LINK2 registers (continued)

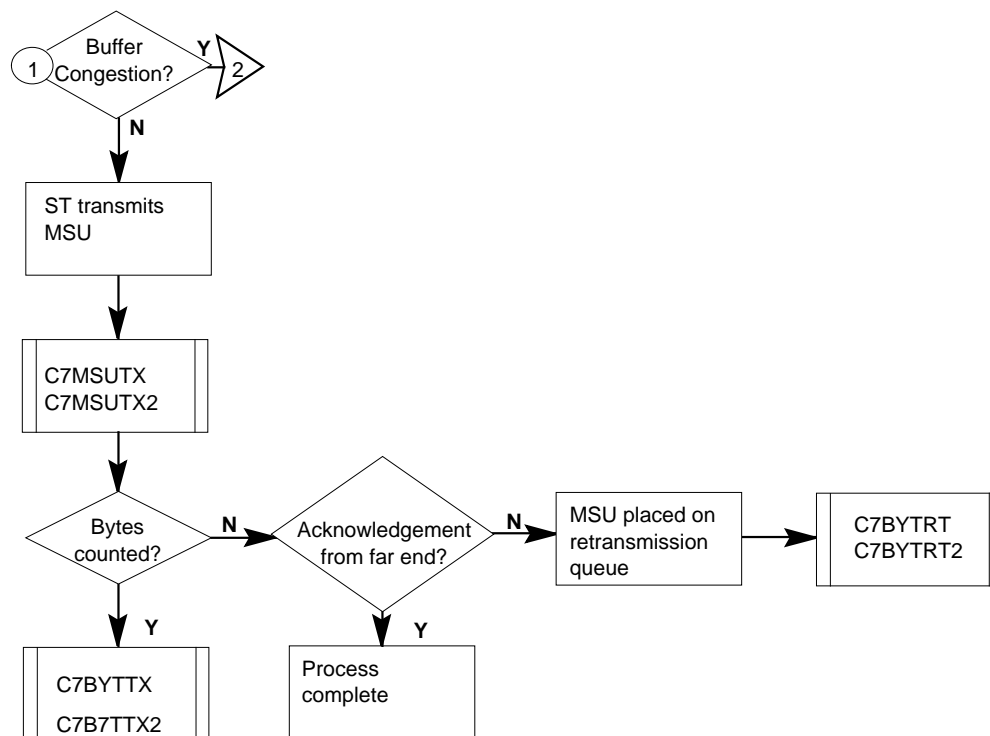

OM group C7LINK2 (continued)

OM group C7LINK2 registers (continued)

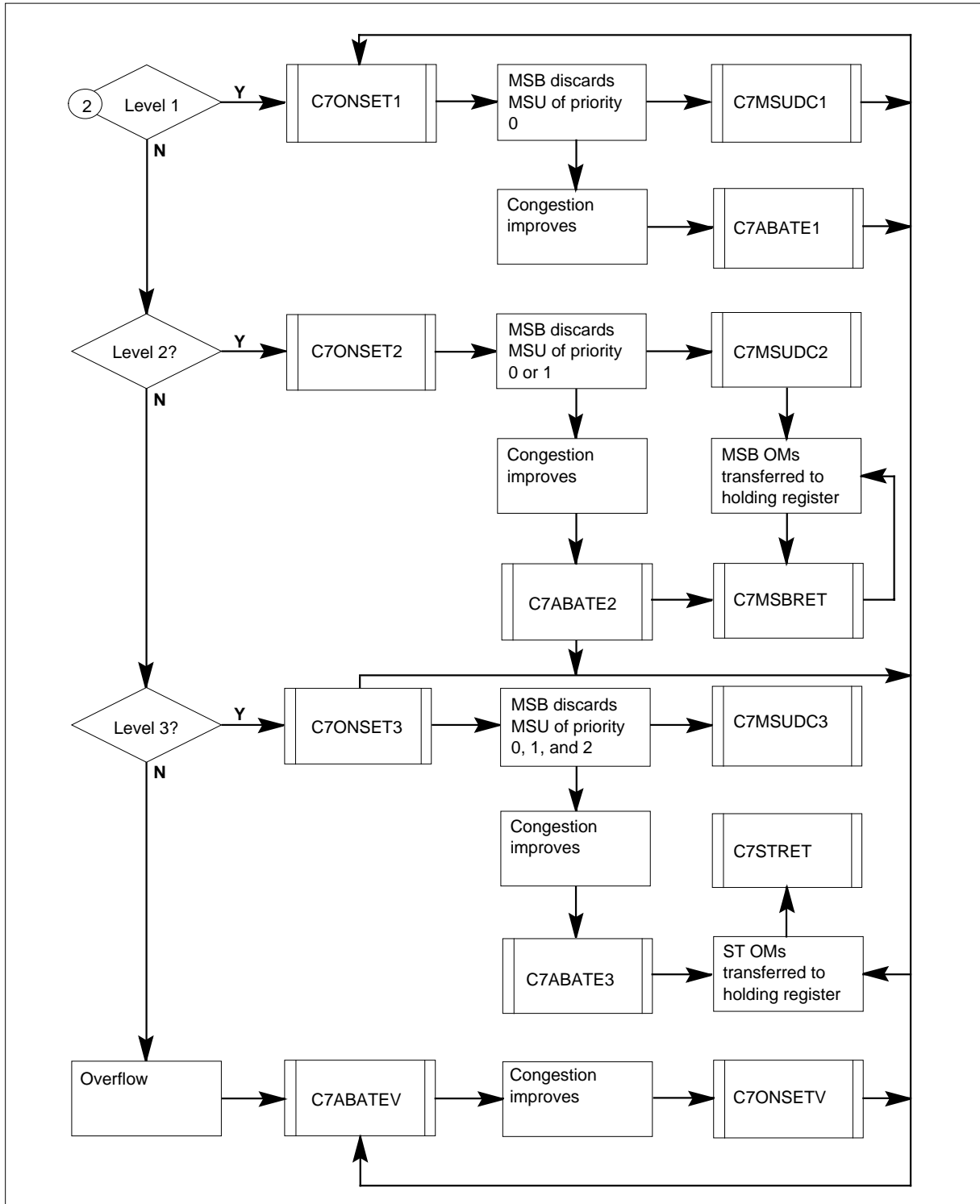

OM group C7LINK2 (continued)

Register C7ABATE1

CCS7 abatement threshold 1 (C7ABATE1)

C7ABATE1 increases when the transmission buffer congestion for the signaling terminal (ST) falls below the first abatement threshold. This register collects data in the CC.

Register C7ABATE1 release history

Register C7ABATE1 was introduced in BCS20.

BCS21

Register C7ABATE1 was activated.

Associated registers

Register C7ABATE2 increases when ST transmission buffer congestion falls below the second abatement threshold. Register C7ABATE3 increases when ST transmission buffer congestion falls below the third abatement threshold.

Associated logs

The system generates log CCS173 when the transmission buffer of a CCS link is congested.

Register C7ABATE2

CCS7 abatement threshold 2 (C7ABATE2)

Register C7ABATE2 increases when ST transmission buffer congestion falls below the second abatement threshold. This register collects data in the CC.

Register C7ABATE2 release history

Register C7ABATE2 was introduced in BCS20.

BCS21

Register C7ABATE2 was activated.

Associated registers

Register C7ABATE1 increases when ST transmission buffer congestion falls below the first abatement threshold. Register C7ABATE3 increases when ST transmission buffer congestion falls below the third abatement threshold.

Associated logs

The system generates log CCS173 when the transmission buffer of a CCS link is congested.

OM group C7LINK2 (continued)

Register C7ABATE3

CCS7 abatement threshold 3 (C7ABATE3).

Register C7ABATE3 increases when ST transmission buffer congestion falls below the third abatement threshold. This register collects data in the CC.

Register C7ABATE3 release history

Register C7ABATE3 was introduced in BCS20. Register C7ABATE3 was set to zero.

BCS21

Register C7ABATE3 was activated.

Associated registers

Register C7ABATE1 increases when ST transmission buffer congestion falls below the first abatement threshold. Register C7ABATE2 increases when ST transmission buffer congestion falls below the second abatement threshold.

Associated logs

The system generates log CCS173 when the transmission buffer of a CCS link is congested.

Register C7ABATEV

CCS7 abatement overflow (C7ABATEV)

Register C7ABATEV increases when the signaling terminal ST transmission buffer congestion falls below the ST transmission buffer overflow threshold. Messages of all priorities are transmitted. This register collects data in the CC.

Register C7ABATEV release history

Register C7ABATEV was introduced in BCS21.

Associated registers

Register C7ABATE1 increases when ST transmission buffer congestion falls below the first abatement threshold. Register C7ABATE2 counts the number of times the ST transmission buffer congestion falls below the second abatement threshold. Register C7ABATE3 counts the number of times ST transmission buffer congestion level falls below the third abatement threshold.

Associated logs

The system generates log CCS173 when the transmission buffer of a CCS7 link is congested.

OM group C7LINK2 (continued)

Register C7BYTRT

CCS7 bytes retransmitted (C7BYTRT)

Register C7BYTRT counts bytes that the ST transmits again. These bytes include the data service information (SIO) and signaling information field (SIF) data. These bytes do not include the sequence number, length, and priority checking data. This data is referred to as level 2 overhead data.

Register C7BYTRT release history

Register C7BYTRT was introduced in BCS20.

Associated registers

Register C7STRET increases when the information collected in the following registers is transferred from the ST to the CC:

- register C7BYTRT
- register C7BYTRT2
- register C7BYTRX
- register C7BYTRX2
- register C7BYTTX
- register C7BYTTX2
- register C7MSURX
- register C7MSURX2
- register C7MSUTX
- register C7MSUTX2
- register C7MSUDC

Associated logs

There are no associated logs.

Extension registers

C7BYTRT2

Register C7BYTRX

CCS7 bytes received (C7BYTRX)

Register C7BYTRX counts bytes that the ST receives. These bytes include the SIO and SIF data. These bytes do not include the sequence number, length, and priority checking overhead data. This data is referred to as level 2 overhead data.

OM group C7LINK2 (continued)

Register C7BYTRX release history

Register C7BYTRX was introduced in BCS20.

Associated registers

Register C7STRET increases when the information collected in the following registers is transferred from the ST to the CC:

- register C7BYTRT
- register C7BYTRT2
- register C7BYTRX
- register C7BYTRX2
- register C7BYTTX
- register C7BYTTX2
- register C7MSURX
- register C7MSURX2
- register C7MSUTX
- register C7MSUTX2
- register C7MSUDC

Associated logs

There are no associated logs.

Extension registers

C7BYTRX2

Register C7BYTTX

CCS7 bytes transmitted (C7BYTTX)

Register C7BYTTX counts bytes that the ST transmits. These bytes include the SIO and SIF data. These bytes do not include the sequence number, length, and priority checking data. This data is referred to as level 2 overhead data.

Register C7BYTTX release history

Register C7BYTTX was introduced in BCS20.

OM group C7LINK2 (continued)

Associated registers

Register C7STRET increases when information collected in the following registers is transferred from the ST to the CC:

- register C7BYTRT
- register C7BYTRT2
- register C7BYTRX
- register C7BYTRX2
- register C7BYTTX
- register C7BYTTX2
- register C7MSURX
- register C7MSURX2
- register C7MSUTX
- register C7MSUTX2
- register C7MSUDC

Associated logs

There are no associated logs.

Extension registers

C7BYTTX2

Register C7MSBRET

CCS7 message switch buffer retrieval (C7MSBRET)

Register C7MSBRET increases when information is transferred to a holding registers in the CC. Registers that reside in the link-handling peripheral module (PM), which is an MSB, LIU7, or HLIU, collect this information. Registers C7MSUDC1, C7MSUDC2, and C7MSUDC3 reside in the PM that handles the link.

Register C7MSBRET release history

Register C7MSBRET was introduced in BCS21.

Associated registers

There are no associated registers.

Associated logs

There are no associated logs.

OM group C7LINK2 (continued)

Register C7MSGLOS

CCS7 messages lost (C7MSGLOS)

Register C7MSGLOS counts messages that are lost on paths from an incoming LIU7 or HLIU link to all outgoing LIU7 or HLIU links in the STP.

To find the reliability of the signal transfer point in terms of message loss, perform the following calculation. Compare the sum of register C7MSGLOS for all links to the sum of registers C7MSURX and C7MSURX2.

Register C7MSGLOS release history

Register C7MSGLOS was introduced in BCS25.

Associated registers

To find the performance measurement of the reliability of the signal transfer point, in terms of message loss, perform the following calculation. Compare the sum of register C7MSGLOS to the sum of registers C7MSURX and C7MSURX2.

Associated logs

The system generates CCS400 when a path from one LIU7, HLIU, or HSLR to another is defective.

Register C7MSGMSQ

CCS7 messages mis-sequenced (C7MSGMSQ)

Register C7MSGMSQ counts messages that are received out of their correct order on paths from all incoming LIU7 or HLIU links. The messages are sent to a given destination LIU7 or HLIU in the STP. This register collects data in the destination LIU7 or HLIU. This register also provides a cumulative count of all messages that are not sequenced correctly on all paths to the destination.

To find a performance measurement of the reliability of the STP in terms of message sequencing, perform the following calculation. Compare the sum of register C7MSGMSQ for all links to the sum of the OM that counts messages received (C7MSURX/C7MSURX2).

Register C7MSGMSQ release history

Register C7MSGMSQ was introduced in BCS25.

Associated registers

There are no associated registers.

OM group C7LINK2 (continued)

Associated logs

There are no associated logs.

Register C7MSUDC1

CCS7 messages discarded because of congestion level 1 (C7MSUDC1)

Register C7MSUDC1 counts messages discarded by the PM (MSB, LIU7, or HLIU) that supports the link experiencing congestion level 1.

If this count increases, take action to improve link transmission or to reduce the traffic load on the link. This register collects data in the PM that handles the link. This register is transferred to the CC during the OM transfer process.

Register C7MSUDC1 release history

Register C7MSUDC1 was introduced in BCS20.

BCS21

Register C7MSUDC1 was activated.

Associated registers

Register C7MSUDC2 counts messages discarded by the PM that handles the link. Link congestion at level 2 causes the PM to discard the messages.

Register C7MSUDC3 counts the number of messages discarded by the PM that handles the link. Link congestion at level 3 causes the PM to discard the messages.

Register C7MSBRET increases when information collected in C7MSUDC1 is transferred from the PM that handles the link to the CC.

Associated logs

There are no associated logs.

Register C7MSUDC2

CCS7 messages discarded because of congestion level 2 (C7MSUDC2)

Register C7MSUDC2 counts messages discarded by the PM that handles the link. The PM discards the messages when signal routing is at link congestion level 2.

If this count increases, take action to improve link transmission or to reduce the traffic load on the link. This register collects data in the PM that handles the link. This register is transferred to the CC during the OM transfer process.

OM group C7LINK2 (continued)

Register C7MSUDC2 release history

Register C7MSUDC2 was introduced in BCS20.

BCS21

Register C7MSUDC2 was activated

Associated registers

Register C7MSUDC1 counts messages discarded by the PM that handles the link. Link congestion at level 1 causes the PM to discard messages.

Register C7MSUDC3 counts messages discarded by the PM that handles the link. Link congestion at level 3 causes the PM to discard the signal message units.

Register C7MSBRET increases when information collected in C7MSUDC2 is transferred from the PM that handles the links to the CC.

Associated logs

There are no associated logs.

Register C7MSUDC3

CCS7 messages discarded because of congestion level 3 (C7MSUDC3)

Register C7MSUDC3 counts messages discarded by the PM (an MSB, LIU7, or HLIU link) that supports the link experiencing link congestion level 3.

If this count increases, take action to improve link transmission or reduce the traffic load on the link. This register collects data in the link-handling PM and transfers to the CC during the OM transfer process.

Register C7MSUDC3 release history

Register C7MSUDC3 was introduced in BCS20 and set to zero.

BCS21

Register C7MSUDC3 was activated.

Associated registers

Register C7MSUDC1 counts messages discarded by the link-handling PM because of link congestion at level 1.

Register C7MSUDC2 counts messages discarded by the link-handling PM because of link congestion at level 2.

OM group C7LINK2 (continued)

Register C7MSBRET increases when information collected in C7MSUDC3 transfers from the link-handling PM to the CC.

Associated logs

There are no associated logs.

Register C7MSUDSC

CCS7 messages discarded (C7MSUDSC)

Register C7MSUDSC counts message signal units that the ST discards because of congestion overflow in the transmission buffer beyond congestion level 3. If this count persists, take action to improve link transmission or reduce the traffic load on the link. This register collects data in the ST and transfers to the CC during the OM transfer process.

Register C7MSUDSC release history

Register C7MSUDSC was introduced in BCS20.

Associated registers

Register C7STRET increases when the information collected in the following registers is transferred from the ST to the CC:

- Register C7BYTRT
- Register C7BYTRT2
- Register C7BYTRX
- Register C7BYTRX2
- Register C7BYTTX
- Register C7BYTTX2
- Register C7MSURX
- Register C7MSURX2
- Register C7MSUTX
- Register C7MSUTX2
- Register C7MSUDC

Associated logs

There are no associated logs.

Register C7MSUOR

CCS7 messages originated (C7MSUOR)

OM group C7LINK2 (continued)

Register C7MSUOR counts messages that originate at the ST. Messages that originate at the ST include global title translations (GTT) and management messages.

This register is activated only for LIU7 or HLIU.

Register C7MSUOR release history

Register C7MSUOR was introduced in BCS21.

Associated registers

There are no associated registers.

Associated logs

There are no associated logs.

Extension registers

C7MSUOR2

Register C7MSURX

CCS7 messages received (C7MSURX)

Register C7MSURX counts messages the ST received.

This register collects data in the ST and transfers to the CC during the OM transfer process.

Register C7MSURX release history

Register C7MSURX was introduced in BCS20.

Associated registers

Register C7STRET increases when the information collected in the following registers is transferred from the ST to the CC:

- Register C7BYTRT
- Register C7BYTRT2
- Register C7BYTRX
- Register C7BYTRX2
- Register C7BYTTX
- Register C7BYTTX2
- Register C7MSURX
- Register C7MSURX2

OM group C7LINK2 (continued)

- Register C7MSUTX
- Register C7MSUTX2
- Register C7MSUDC

Associated logs

There are no associated logs.

Extension registers

C7MSURX2

Register C7MSUTE

CCS7 messages terminated (C7MSUTE)

Register C7MSUTE counts messages that terminate at the node.

This register is activated for products based on the LIU7 or HLIU.

Register C7MSUTE release history

Register C7MSUTE was introduced in BCS25.

Associated registers

There are no associated registers.

Associated logs

There are no associated logs.

Extension registers

C7MSUTE2

Register C7MSUTS

CCS7 messages through-switched (C7MSUTS)

Register C7MSUTS counts messages that an STP or integrated node (INode) relays to other signaling points.

Register C7MSUTS release history

Register C7MSUTS was introduced in BCS25.

Associated registers

There are no associated registers.

OM group C7LINK2 (continued)

Associated logs

There are no associated logs.

Extension registers

C7MSUTS2

Register C7MSUTX

CCS7 messages transmitted (C7MSUTX)

Register C7MSUTX counts messages that the ST transmits.

This register collects data in the ST and is transferred to the CC during the OM transfer process.

Register C7MSUTX release history

Register C7MSUTX was introduced in BCS20.

Associated registers

Register C7STRET increases when the information collected in the following registers is transferred from the ST to the CC:

- Register C7BYTRT
- Register C7BYTRT2
- Register C7BYTRX
- Register C7BYTRX2
- Register C7BYTTX
- Register C7BYTTX2
- Register C7MSURX
- Register C7MSURX2
- Register C7MSUTX
- Register C7MSUTX2
- Register C7MSUDC

Associated logs

There are no associated logs.

Extension registers

C7MSUTX2

OM group C7LINK2 (continued)

Register C7ONSET1

CCS7 onset threshold 1 (C7ONSET1)

Register C7ONSET1 increments when ST transmission buffer congestion passes the first onset threshold. The user must enter thresholds in table C7CNGSTN.

When congestion passes the first threshold, the system discards messages of priority 0. The link transports messages of priority 1, 2, and 3. If congestion persists the user must improve link transmission or reduce the traffic load on the link. This register collects data in the CC.

Register C7ONSET1 release history

Register C7ONSET1 was introduced in BCS20.

BCS21

Register C7ONSET1 was activated.

Associated registers

Register C7ONSET 2 increases when ST transmission buffer congestion passes the second onset threshold.

Register C7ONSET3 increases when ST transmission buffer congestion passes the third onset threshold.

Associated logs

The system generates CCS173 when the transmission buffer of a CCS7 link is congested.

Register C7ONSET2

CCS7 onset threshold 2 (C7ONSET2)

Register C7ONSET2 increments when ST transmission buffer congestion passes the second onset threshold.

When congestion passes the second threshold, the system discards messages of priority zero. The link will transport messages of priority 2 and 3. If congestion persists, the user must improve link transmission or reduce the traffic load on the link. This register collects data in the CC.

Register C7ONSET2 release history

Register C7ONSET2 was introduced in BCS20.

OM group C7LINK2 (continued)

BCS21

Register C7ONSET2 was activated.

Associated registers

Register C7ONSET1 increases when ST transmission buffer congestion passes the first onset threshold.

Register C7ONSET3 increases when ST transmission buffer congestion passes the third onset threshold.

Associated logs

The system generates CCS173 when the transmission buffer of a CCS7 link is congested.

Register C7ONSET3

CCS7 onset threshold 3 (C7ONSET3)

Register C7ONSET3 increments when ST transmission buffer congestion passes the third onset threshold.

When congestion passes the third threshold, the system discards messages of priority 0 and 1. The link will transport messages of priority 3. If congestion persists, the user must take action to improve link transmission or reduce the traffic load on the link. This register collects data in the CC.

Register C7ONSET3 release history

Register C7ONSET3 was introduced in BCS20.

BCS21

Register C7ONSET3 was activated.

Associated registers

Register C7ONSET1 increases when ST transmission buffer congestion passes the first onset threshold.

Register C7ONSET2 increases when ST transmission buffer congestion passes the second onset threshold.

Associated logs

The system generates log CCS173 when the transmission buffer of a CCS7 link is congested.

Register C7ONSETV

CCS7 onset overflow (C7ONSETV)

OM group C7LINK2 (continued)

Register C7ONSETV increases when messages overflow the ST transmission buffer. When this occurs, the system discards all calls. This register collects data in the CC.

Register C7ONSETV release history

Register C7ONSETV was introduced in BCS21.

Associated registers

Register C7ONSET1 increases when ST transmission buffer congestion passes the first onset threshold.

Register C7ONSET2 increases when ST transmission buffer congestion passes the second onset threshold.

Register C7ONSET3 increases when the ST transmission buffer congestion passes the third onset threshold.

Associated logs

The system generates log CCS173 when the transmission buffer of a CCS link is congested.

Register C7STRET

CCS7 signal terminal retrieval (C7STRET)

Register C7STRET increases when the information that registers collect transfers to a holding register in the CC. These registers are in the ST of the link.

The registers in the ST of the link are as follows:

- Register C7BYTRT
- Register C7BYTRT2
- Register C7BYTRX
- Register C7BYTRX2
- Register C7BYTTX
- Register C7BYTTX2
- Register C7MSURX
- Register C7MSURX2
- Register C7MSUTX

OM group C7LINK2 (end)

- Register C7MSUTX2
- Register C7MSUDC

Register C7STRET release history

Register C7STRET was introduced in BCS21.

Associated registers

There are no associated registers.

Associated logs

There are no associated logs.

OM group C7LINK3

OM description

Common Channel Signaling 7 link group 3 (C7LINK3)

The OM group C7LINK3 monitors the traffic and performance of a message signal unit (MSU) for a Common Channel Signaling 7 (CCS7) link. Message signal units are part of a signal.

The OM group C7LINK3 stores link peripheral processor (LPP) message-type information for each link.

Some registers are registers that count MSU octets that originate, terminate, and connect through a switch through an office. These registers also monitor MSU traffic. The following components measure performance:

- registers that count the number of times that local and remote processors are not in service
- MSUs that the system loses because no buffers are available to store messages
- usage registers that record link levels 1, 2, and 3 of congestion on a CCS7 link.

Registers C7MSOR, C7MSOR2, C7MSTE, C7MSTE2, C7MSTS, C7MSTS2, and C7MSUBOV in OM group C7LINK3 only apply to LPP-based CCS7 nodes. These registers are not valid on MSB7-based nodes.

The system uses the OM group C7LINK3 in the Signaling Engineering Administration System (SEAS) for CCS7 offices. Data in C7MTP goes to the signaling engineering administration controller (SEAC) for use in SEAS.

Note: The SEAS does not support registers VALIDLK, LSCCPRX, LSCCPRX2, LSCCPTX, LSCCPTX2, LUPARX, LUPARX2, and LUPATX2.

For the SEAC to collect the correct data, the following condition must be present. Table OMACC must define three classes to accumulate the required 30 min, 60 min, and 24 h collection periods. Modify tables OFCOPT and OFCENG to provide the required 5 min reports for SEAC. The "Group structure" section describes modifications to tables OFCOPT and OFCENG.

Release history

BCS28 introduced the OM group C7LINK3.

OM group C7LINK3 (continued)**STP04**

Registers VALIDLK, LSCCPRX, LSCCPRX2, LSCCPTX, LSCCPTX2, LUPARX, LUPARX2, LUPATX, and LUPATX2 were added in STP04.

CSP04

Register C7CLBU was added in CSP04.

BCS35

Registers C7HWILLP, C7HWMTS, C7HWST, C7HWTOT, C7RTOVLD, and C7BFOVFL were added but not activated in BCS35.

BCS30

Software change to provide usage counts in hundred call seconds (CCS) or deci-erlangs.

Registers

The OM group C7LINK3 registers appear on the MAP terminal as follows:

C7MSOR	C7MSOR2	C7MSTE	C7MSTE2
C7MSTS	C7MSTS2	C7MSUBOV	C7LV1CGU
C7LV2CGU	C7LV3CGU	C7LPOU	C7RPOU
C7HWILLP	C7HWMTS	C7HWST	C7HWTOT
C7RTOVLD	C7BFOVFL	C7CLBU	VALIDLK
LSCCPRX	LSCCPRX2	LSCCPTX	LSCCPTX2
LUPARX	LUPARX2	LUPATX	LUPATX2

Group structure

The OM group C7LINK3 provides one tuple for each CCS7 link.

Keyfield:

C7_LINKSET_NUMBER, a number between 0 and 254, for use as an index into table C7LKSET

Info field:

C7LINK_OMINFO

The following information is the group structure for OM group C7LINK3 for STP nodes:

The OM group C7LINK3 provides 21 tuples for each CCS7 link.

Keyfield:

C7_LINKSET_NUMBER_TYPEID

OM group C7LINK3 (continued)

Info field:

C7LINK2_OM_FLDS

The OM group C7LINK3 uses information in tables C7LINK and LIUINV. Table C7LINK stores the size of the CCS7 link messages. Table LIUINV specifies the controlling entity of the link interface unit (LIU) as the message switch (MS) or the link interface module (LIM).

The SEAC OM collection requirements require the following table modifications:

- Add SEAS_30M, SEAS_60M, and SEAS_24H to table OMACC.
- Add group C7LINK3 and corresponding fields (registers) to each of the three classes.
- Set OMHISTORYON to Y in table OFCOPT.
- Set OMXFR to X15 in table OFCENG.

Associated OM groups

The SEAS also uses OM groups C7LINK1, C7LINK2, C7MTP, and C7SCCP to provide performance measurements for CCS7 offices.

The OM groups C7LINK1, C7LINK2, and C7LINK3 display the OM data for each link.

The OM group C7LINK1 counts failures and recoveries of a CCS7 link.

The OM group C7LINK2 records congestion and traffic measurements on a CCS7 link.

The OM group C7MTP counts message signal units that the system discards at a signaling transfer point.

The OM group C7SCCP records the performance and use of a CCS7 signaling-connection control part.

The OM group C7LINK1 register C7CLB counts the number of times a link was in the controlled link blocking (CLB) state.

Associated functional groups

The following functional groups associate with OM group C7LINK3:

- SEAS
- SEAC

OM group C7LINK3 (continued)

- CCS7
- High-speed link interface unit (HLIU)

Associated functionality codes

The functionality codes associated with OM group C7LINK3 appear in the following table.

Functionality	Code
STP-SEAS	NTX835AA
International Switching Center--Basic	NTX300AA
CCS7 MTP/SCCP	NTX041AB
High-speed link interface unit (HLIU)	STPE006

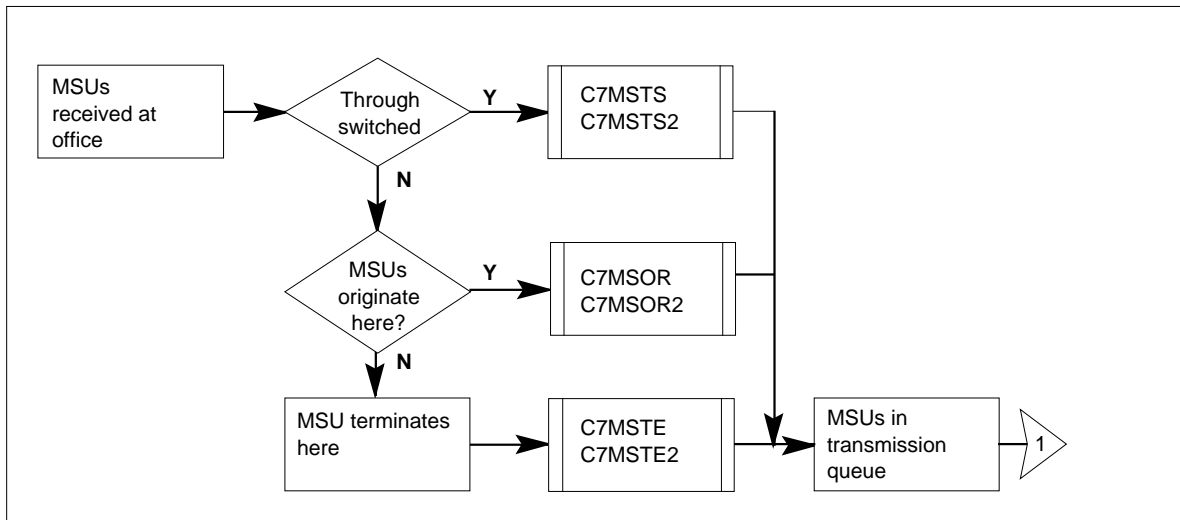
OM group C7LINK3 registers

OM group C7LINK3 (continued)

OM group C7LINK3 registers (continued)

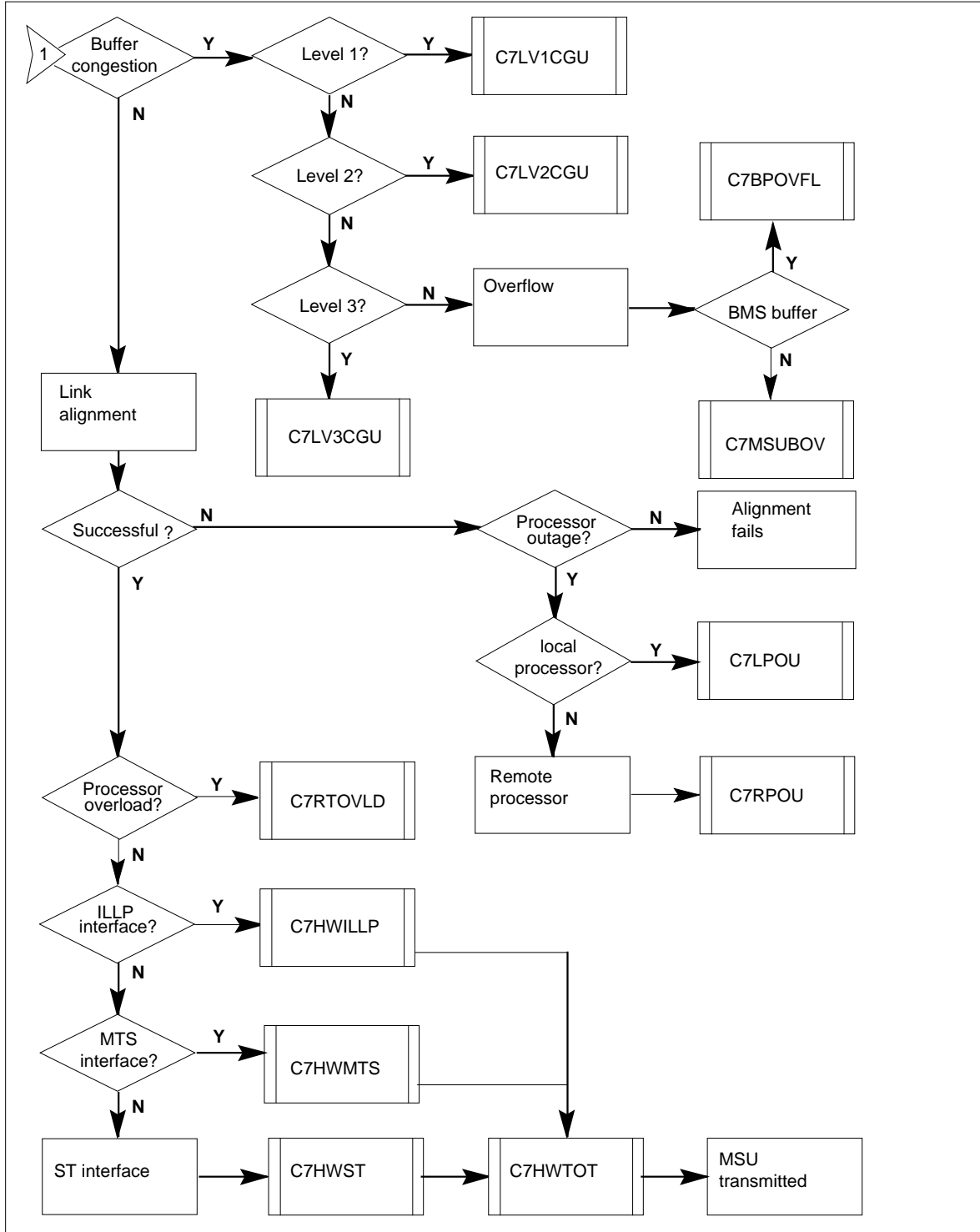

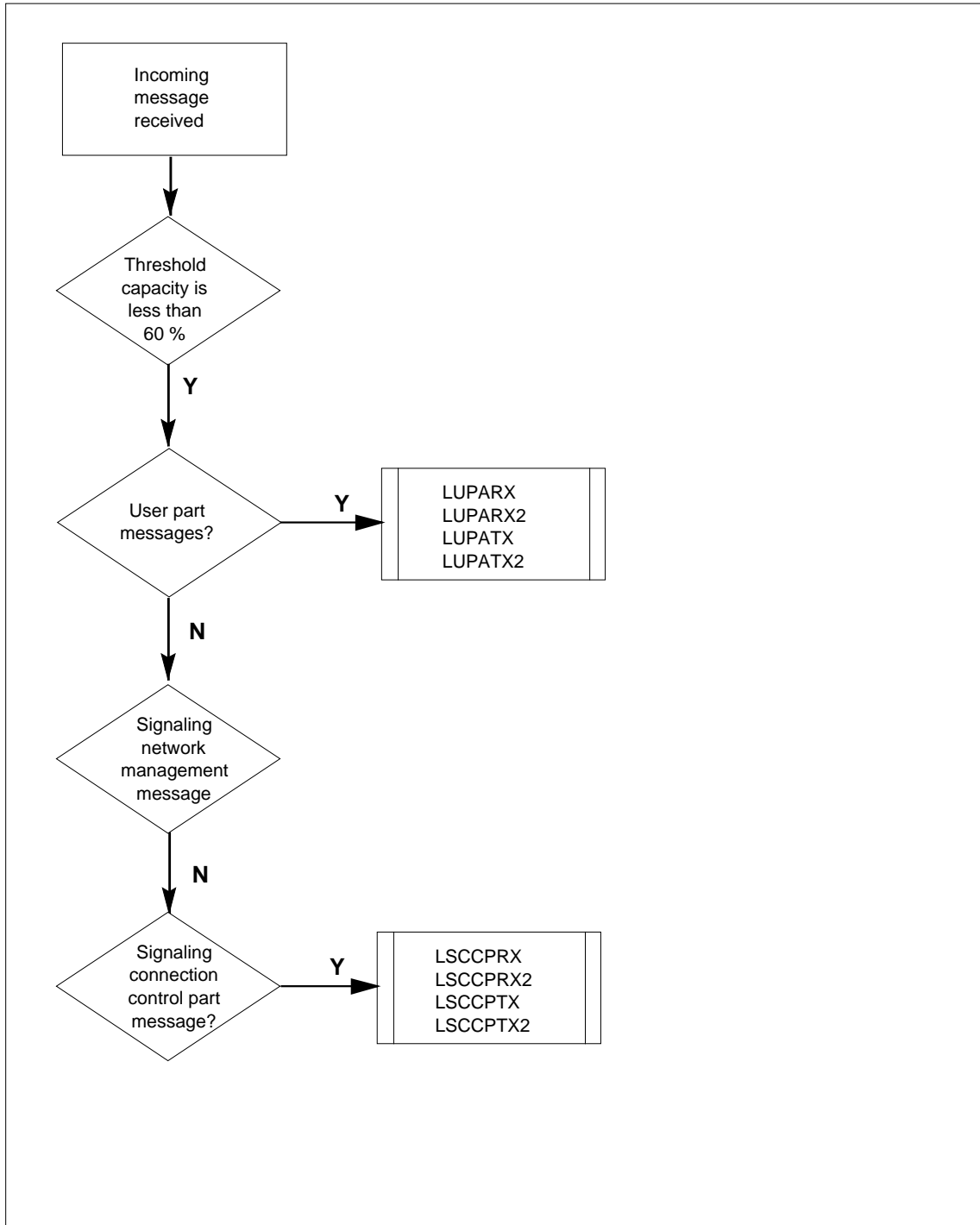
OM group C7LINK3 (continued)**OM group C7LINK3 message type registers**

OM group C7LINK3 (continued)

Register C7BFOVL

CCS7 buffer overflow (C7BFOVL)

Register C7BFOVL counts the times the system discards a message because message buffers are not available in the CCS7 link interface unit (LIU7).

This register is set to zero (0).

Register-C7BFOVL release history

The BCS35 introduced register C7BFOVL.

Associated registers

There are no associated registers.

Associated logs

There are no associated logs.

Register C7HWILLP

CCS7 high-water mark for ILLP interface (C7HWILLP)

Register C7HWILLP counts the highest number of messages or MSUs that are received in 1 s from the ILLP interface.

This register is set to zero (0).

Register-C7HWILLP release history

The BCS35 introduced register C7HWILLP.

Associated registers

There are no associated registers

Associated logs

There are no associated logs

Register C7HWMTS

CCS7 high-water mark for MTS interface (C7HWMTS)

Register C7HWMTS counts the highest number of messages or MSUs received in 1 s from the MTS interface.

This register is set to zero (0).

OM group C7LINK3 (continued)

Register-C7HWMTS release history

The BCS35 introduced register C7HWMTS.

Associated registers

There are no associated registers.

Associated logs

There are no associated logs.

Register C7HWST

CCS7 high-water mark for ST interface (C7HWST)

Register C7HWST counts the highest number of messages or MSUs received in 1 s from the signaling terminal (ST) interface.

This register is set to zero (0).

Register-C7HWST release history

The BCS35 introduced register C7HWST.

Associated registers

There are no associated registers

Associated logs

There are no associated logs

Register C7HWTOT

CCS7 high-water mark total interfaces (C7HWTOT)

Register C7HWTOT counts the highest number of messages or MSUs received in 1 s from all interfaces (ILLP, MTS, and ST).

This register is set to zero (0).

Register-C7HWTOT release history

The BCS35 introduced C7HWTOT.

Associated registers

There are no associated registers.

Associated logs

There are no associated logs.

OM group C7LINK3 (continued)

Register C7LPOU

CCS7 local processor outage (C7LPOU)

Register C7LPOU is a usage register. The scan rate is 10 s. Register C7LPOU records each local processor outage (LPO) that the signaling terminal (ST) detects.

Register C7LPOU records outages. The following conditions can cause outages:

- a CCS7-message switch and buffer (MSB7) outage is present
- the local processor is manual busy (the user takes the link out of service)
- inhibit procedures control a link

An MSB7 outage can cause the LPO. This condition indicates that an important problem occurred. If manual busy or inhibit procedures cause the LPO, the system raises an alarm.

This register increases in the ST and transfers to the central control (CC) during the OM transfer process.

Register-C7LPOU release history

The BCS28 introduced register C7LPOU.

BCS30

Software change to provide usage counts in hundred call seconds (CCS) or deci-erlangs.

Associated registers

Register C7RPOU is a usage register. The scan rate is 10 s. Register C7RPOU records remote processor outages that the signaling terminal (ST) reports.

Register C7LPOU corresponds to DRLCLPRO in SEAS.

Associated logs

The system generates log PM102 when a peripheral module changes to system busy by a system request.

The system generates log PM105 when a peripheral module changes to manual busy by a manual request.

Register C7LV1CGU

CCS7 level 1-link congestion (C7LV1CGU)

OM group C7LINK3 (continued)

Register C7LV1CGU is a usage register. The scan rate is 10 s. Register C7LV1CGU records level 1-link congestion on a CCS7 link. Table C7CNGSTN contains descriptions of thresholds of link congestion.

Register-C7LV1CGU release history

The BCS28 introduced register C7LV1CGU.

BCS30

Software change to provide usage counts in hundred call seconds (CCS) or deci-erlangs.

Associated registers

Register C7LV1CGU corresponds to TDCNGLV1 in SEAS.

Associated logs

There are no associated logs

Register C7LV2CGU

CCS7 level 2-link congestion (C7LV2CGU)

C7LV2CGU is a usage register. The scan rate is 10 s. Register C7LV2CGU records level 2 congestion on a CCS7 link. Table C7CNGSTN contains descriptions of thresholds of link congestion.

Register-C7LV2CGU release history

The BCS28 introduced register C7LV2CGU.

BCS30

Software change to provide usage counts in hundred call seconds (CCS) or deci-erlangs.

Associated registers

Register C7LV2CGU corresponds to TDCNGLV2 in SEAS.

Associated logs

There are no associated logs.

Register C7LV3CGU

CCS7 level 3-link congestion (C7LV3CGU)

Register C7LV3CGU is a usage register. The scan rate is 10 s. Register C7LV3CGU records level 3 congestion on a CCS7 link. Table C7CNGSTN contains descriptions of thresholds of link congestion.

OM group C7LINK3 (continued)

Register-C7LV3CGU release history

The BCS28 introduced register C7LV3CGU.

BCS30

Software change to provide usage counts in hundred call seconds (CCS) or deci-erlangs.

Associated registers

Register C7LV3CGU corresponds to TDCNGLV3 in SEAS.

Associated logs

There are no associated logs

Register C7MSOR

CCS7 message signal unit (MSU) octets originated (C7MSOR)

Register C7MSOR counts MSU octets that originate on a CCS7 link in an office. Register C7MSOR includes management MSUs and global title translations that generate new messages.

Registers C7MSOR and C7MSOR2 apply to LPP-based CCS7 nodes. These registers are not valid on MSB7-based nodes.

Register-C7MSOR release history

The BCS28 introduced register C7MSOR.

Associated registers

Registers C7MSOR and C7MSOR2 correspond to ORMSUOCT in SEAS.

Associated logs

There are no associated logs

Extension Register

C7MSOR2

Register C7MSTE

CCS7 message signal unit (MSU) octets terminated (C7MSTE)

Register C7MSTE counts MSU octets that terminate on a CCS7 link in an office. Register C7MSTE includes management MSUs and global title translations that generate new messages.

OM group C7LINK3 (continued)

Registers C7MSTE and C7MSTE2 apply to LPP-based CCS7 nodes. These registers are not valid on MSB7-based nodes.

Register-C7MSTE release history

The BCS28 introduced register C7MSTE.

Associated registers

Registers C7MSTE and C7MSTE2 correspond to TRMSUOCT in SEAS.

Associated logs

There are no associated logs

Extension Register

C7MSTE2

Register C7MSTS

CCS7 message signal unit (MSU) octets through-switched (C7MSTS)

Register C7MSTS counts MSU octets that switch through an office. Register C7MSTS does not include global title translations.

Registers C7MSTS and C7MSTS2 apply to LPP-based CCS7 nodes. These registers are not valid on MSB7-based nodes.

Register-C7MSTS release history

The BCS28 introduced register C7MSTS.

Associated registers

Registers C7MSTS and C7MSTS2 correspond to TSMSUOCT in SEAS.

Associated logs

There are no associated logs

Extension Register

C7MSTS2

Register C7MSUBOV

CCS7 message signal unit (MSU) buffer overflow (C7MSUBOV)

Register C7MSUBOV counts MSUs that the system loses because buffers are not available to store messages.

OM group C7LINK3 (continued)

Register C7MSUBOV applies to LPP-based CCS7 nodes. Register C7MSUBOV is not valid on MSB7-based nodes.

Register-C7MSUBOV release history

The BCS28 introduced register C7MSUBOV.

Associated registers

There are no associated registers.

Associated logs

There are no associated logs.

Register C7RPOU

CCS7 remote processor outages (C7RPOU)

Register C7RPOU is a usage register. The scan rate is 10 s. Register C7RPOU records remote processor outages the signaling terminal (ST) reports.

Remote processor outages indicate that the link is not able to deliver traffic. The system raises an alarm. The local office must wait for the far-end signaling point to recover.

The central control (CC) counts register C7RPOU.

Register-C7RPOU release history

The BCS28 introduced register C7RPOU.

Associated registers

Register C7LPOU increases when a local link processor is not in service.

Register C7RPOU corresponds to DRFEPRO in SEAS

Associated logs

The system generates log CCS104 RPO when the far end of a CCS link has a processor outage.

Register C7RTOVLD

CCS7 real time overload (C7RTOVLD)

Register C7RTOVLD counts the number of messages or MSUs that the system discards because an overload occurs in the LIU7.

This register is set to zero (0).

OM group C7LINK3 (continued)

Register-C7RTOVLD release history

The BCS35 introduced register C7RTOVLD.

Associated registers

There are no associated registers.

Associated logs

There are no associated logs.

Register C7CLBU

Register stores the time that the system applies controlled link blocking to the link during an OM period.

The scan rate is 10 s.

Register-C7CLBU release history

The CSP04 introduces register C7CLBU.

Associated registers

Register C7CLBU in the C7LINK3 group stores a time period. This time period is the length of time that the system applied CLB to the link during the last OM period.

Associated logs

The system generates log CCS193 log when the last router goes out of service. The CCS7 links are set to CLB state. The next OM report counts for each link for register C7CLBU.

Register VALIDLK

Validity of the new OM data in table C7LINK3 (VALIDLK)

Register VALIDLK specifies if the added OM data is valid in table C7LINK3. Register VALIDLK also indicates the validity of registers in group C7LPP.

Register VALIDLK release history

The STP04 introduces register VALIDLK.

Associated registers

Registers LSCCPRX, LSCCPRX2, LSCCPTX, LSCCPTX2, LUPARX, LUPARX2, LUPATX, and LUPATX2 associate with the VALIDLK register. Register VALIDLK indicates the validity of each register. The validation formula is 0 for invalid or 1 for valid.

OM group C7LINK3 (continued)

Associated logs

There are no associated logs.

Extension registers

There are no extension registers.

Register LSCCPRX

Incoming SCCP accumulated traffic/link (LSCCPRX)

Register LSCCPRX stores the number of signaling-connection control part (SCCP) messages that the system transmits through a link for one transfer period.

Register-LSCCPRX release history

The STP04 introduces register LSCCPRX.

Associated registers

VALIDLK indicates the validity of register LSCCPRX.

Associated logs

There are no associated logs.

Extension registers

LSCCPRX2

Register LSCCPTX

Outgoing SCCP accumulated traffic/link (LSCCPTX)

Register LSCCPTX stores the number of SCCP messages that the system transmits through a link for one transfer period.

Register-LSCCPTX release history

The STP04 introduces register LSCCPTX.

Associated registers

Register VALIDLK indicates the validity of register LSCCPTX.

Associated logs

There are no associated logs.

Extension registers

LSCCPTX2

Register LUPARX

Incoming user part accumulated traffic/link (LUPARX)

Register LUPARX stores the number of user part messages that the system transmits through a link for one transfer period.

Register-LUPARX release history

The STP04 introduces register LUPARX.

Associated registers

VALIDLK indicates the validity of register LUPARX.

Associated logs

There are no associated logs.

Extension registers

LUPARX2

Register LUPATX

Outgoing user part accumulated traffic/link (LUPATX)

Register LUPATX stores the number of user part messages that the system transmits through a link for one transfer period.

Register-LUPARX release history

The STP04 introduces register LUPATX.

Associated registers

Register VALIDLK indicates the validity of register LUPATX.

Associated logs

There are no associated logs.

Extension registers

LUPATX2

OM group C7LINK4

OM description

CCS7 Additional MTP Layer 3 Events

C7LINK4 provides information related to Common Channel Signaling 7 (CCS7) message transfer part (MTP) layer 3 events.

Release history

OM group C7LINK4 was introduced in TL10.

Registers

The following OM group C7LINK4 registers display on the MAP terminal as follows:

C7OSMSUD	C7ABUFOC	C7PBUFOC	C7ALKODY
C7NMALOD	C7LKFLU	C7LKMTCU	C7HTEACO

Group structure

OM group C7LINK4 provides one tuple for each key.

Key field:

C7_LINKSET_NUMBER. Number in the range 0 to 254, used as an index into table C7LKSET.

Info field:

C7LINK_OMINFO. The Info field has a two-part key: CLLI and C7_SIGLINK_CODE. CLLI is the common language location identifier of the linkset that owns the link. The C7_SIGLINK_CODE is a number from 0 to 15 that identifies the link in the linkset.

Associated OM groups

C7HSLAL2 provides information on CCS7 high-speed link asynchronous transfer mode (ATM) adaptation layer operations.

C7HSLATM provides information on CCS7 high-speed link ATM layer events.

OM group C7LINK4 (continued)

C7HSLCAR provides information on CCS7 high-speed link digital carriers.

C7LINK1 counts failures and recoveries of a CCS7 link.

C7LINK2 provides information on calls and congestion for a CCS7 link.

C7LINK3 monitors traffic and performance of message signal units on a CCS7 link.

C7LKSET provides CCS7 linkset performance information.

Associated functional groups

The following functional groups are associated with OM group C7LINK4:

- Common Channel Signaling 7 (CCS7)

Associated functionality codes

The functionality codes associated with OM group C7LINK4 are shown in the following table.

Functionality	Code
TEL CCS7 Base	TEL00008

OM group C7LINK4 (continued)

OM group C7LINK4

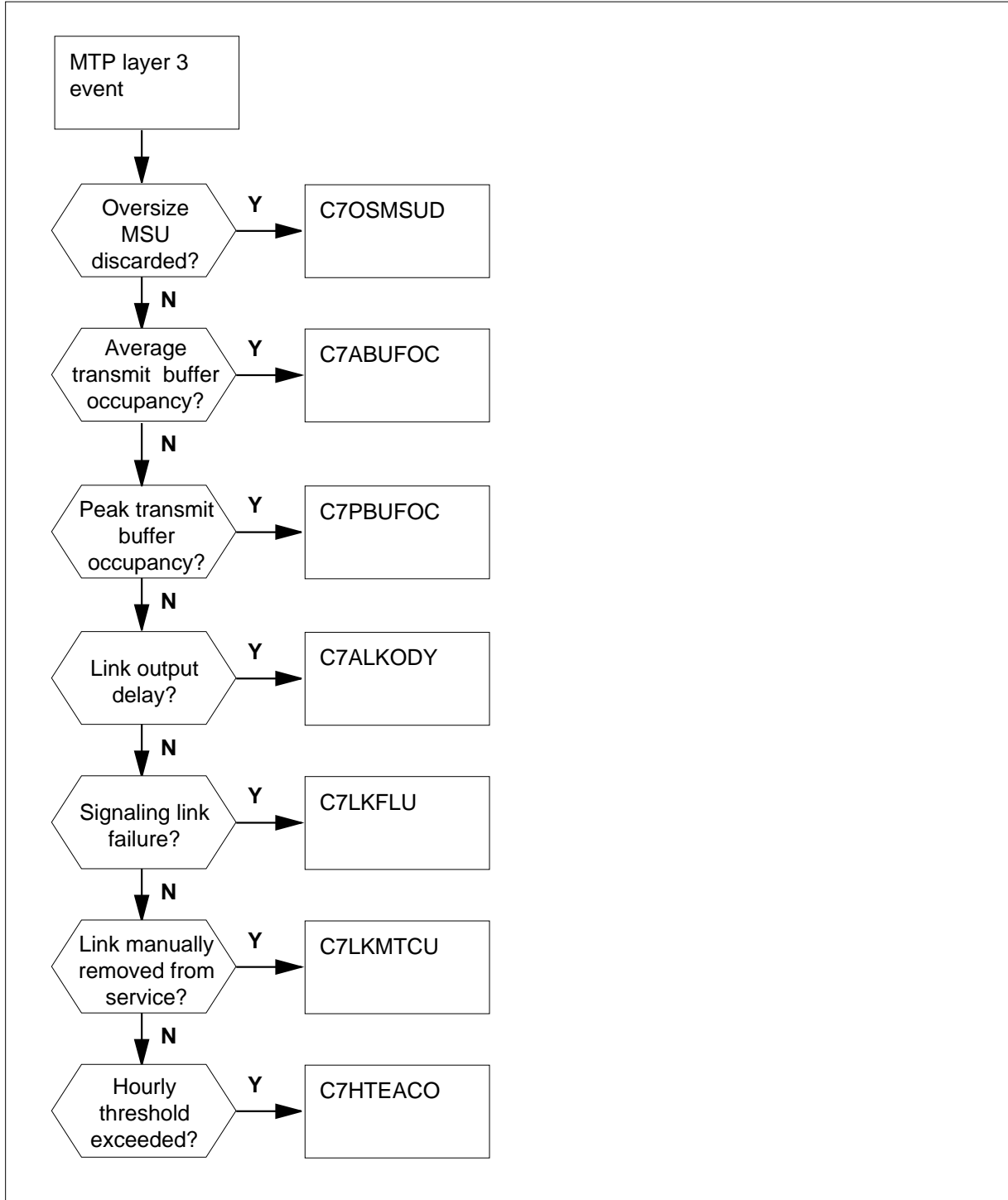

OM group C7LINK4 (continued)

Register C7OSMSUD

CCS7 Oversize MSU Discarded

Register C7OSMSUD counts the number of CCS7 messages discarded because they exceeded the 272-octet message size limit for message signaling units (MSU) on an MTP2 link.

Register C7OSMSUD release history

Register C7OSMSUD was introduced in TL10.

Associated registers

None

Associated logs

None

Extension registers

None

Register C7ABUFOC

CCS7 Average Transmit Buffer Occupancy

Register C7ABUFOC counts the average occupancy of the link transmit buffer in units of MTP3 messages.

Register C7ABUFOC release history

Register C7ABUFOC was introduced in TL10.

Associated registers

None

Associated logs

None

Extension registers

None

Register C7PBUFOC

CCS7 Peak Transmit Buffer Occupancy

Register C7PBUFOC counts the peak occupancy of the link transmit buffer in units of MTP3 messages.

OM group C7LINK4 (continued)

Register C7PBUFOC release history

Register C7PBUFOC was introduced in TL10.

Associated registers

None

Associated logs

None

Extension registers

None

Register C7ALKODY

CCS7 Average Link Output Delay

Register C7ALKODY records the average time of a link output delay in units of microseconds.

Register C7ALKODY release history

Register C7ALKODY was introduced in TL10.

Associated registers

None

Associated logs

None

Register C7NMALOD

Number of Messages Used to Calculate the Average Link Output Delay

Register C7NMALOD counts the number of messages used to calculate the average link output delay.

Register C7NMALOD release history

Register C7NMALOD was introduced in TL10.

Associated registers

None

Associated logs

None

OM group C7LINK4 (continued)

Register C7LKFLU

Cumulative Duration of Signaling Link Failures—All Types

Register C7LKFLU counts the total time that the signaling link was unavailable to MTP level 3 traffic because of signaling link failures. The total time is counted in units of 10 s.

Note: Register C7LKFLU is different from register C7LKUNAU in OM group C7LINK1. C7LKUNAU tracks the unavailability of a link for all reasons. C7LKFLU tracks only the unavailability of a link caused by link failure.

Register C7LKFLU release history

Register C7LKFLU was introduced in TL10.

Associated registers

None

Associated logs

CCS101

Register C7LKMTCU

Link Maintenance Usage

Register C7LKMTCU counts the total time a link was manually made unavailable to MTP level 3 user part message traffic during the measurement interval. The total time is counted in units of 10 s. This includes local or remote management-inhibit, deactivation, or any other manual removal from service.

Register C7LKMTCU release history

Register C7LKMTCU was introduced in TL10.

Associated registers

None

Associated logs

None

Register C7HTEACO

Number of Hourly Thresholds Exceeded for Automatic Changeovers

OM group C7LINK4 (end)

Register C7HTEACO counts the number of times that the automatic changeover hourly threshold is exceeded in a 24 hour period.

Register C7HTEACO release history

Register C7HTEACO was introduced in TL10.

Associated registers

None

Associated logs

CCS120

OM group C7LKSET

OM description

CCS7 linkset (C7LKSET)

The OM group C7LKSET provides information on the performance and use of a CCS7 linkset. The CCS7 affects the performance and use of routesets.

A linkset is a set of synchronized links between any signaling transfer points (STP). A routeset is a set of all routes to a destination in the signaling network. A route is a set of linksets.

The route that a message takes is based on the address and link selector information. The user parts provide the address and link selector in the signaling messages. The system selects a routeset from the signaling routes to a destination. The system selects a linkset and the links in that linkset to route the message.

Routeset management (RSM) determines possible routes for a given routeset and linkset group. The operating company enters a RSM. The RSM examines a route before the RSM routes a message. The RSM checks the traffic capabilities of the route and the linkset for that route. If acceptable routing is available on that route, the RSM selects a link from the linkset. If the first route is not accepted, the RSM examines another route. The RSM repeats this process until the RSM finds an acceptable route, or until the RSM examines all routes.

This group of OMs counts link failures and linkset failures. Failures indicate that the routeset does not transmit messages. The OM group measures the amount of time during which a linkset does not provide calls to a routeset.

Release history

The OM group C7LKSET was introduced in BCS20.

BCS33

Use the OMSHOW command on the ACTIVE class to convert registers C7LSUNAU and C7LSEMURU from CCS to deci-erlangs. Perform this action before the registers appear.

BCS30

Software change to provide use counts in CCS or deci-erlangs.

BCS21

Register C7LSEMURU was introduced.

OM group C7LKSET (continued)

Registers

The OM group C7LKSET registers appear on the MAP terminal as follows:

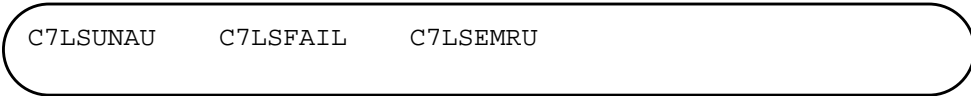

Group structure

The OM group C7LKSET provides one tuple for each key.

Key field:

C7_LINKSET_NUMBER, a number in the range 0 to 254, is an index in table C7LKSET

Info field:

There is no information.

Associated OM groups

The OM groups C7LINK1 and C7LINK2 provide information on link availability and link use.

The OM group C7RTESET provides information on routeset availability.

The OM group C7ROUTE provides information on the component routes.

Associated functional groups

An associated functional group is OM group CCS7.

Associated functionality codes

The functionality codes for OM group C7LKSET appear in the following table.

Functionality	Code
Remote Line Module	NTX023AB
CCS7 MTP/SCCP	NTX041AB
International Switching Center - Basic	NTX300AA

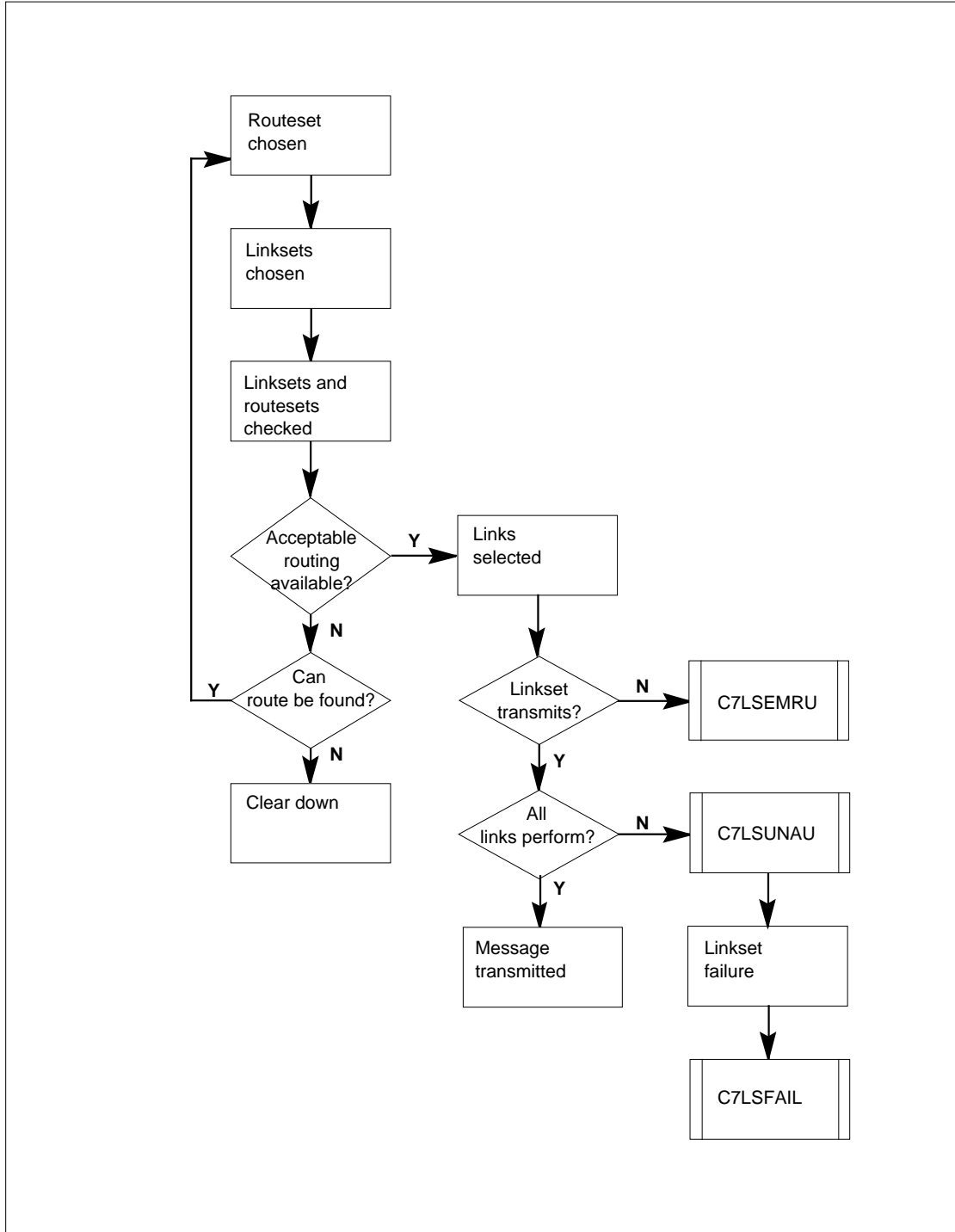
OM group C7LKSET (continued)**OM group C7LKSET registers**

OM group C7LKSET (continued)

Register C7LSEMRU

CCS7 linkset out, routeset traffic blocked (C7LSEMRU)

Register C7LSEMRU is a usage register. The scan rate is 10 s. Register C7LSEMRU records when the following conditions occur:

- the linkset does not transmit messages to the routesets
- a minimum of one routeset does not receive messages

Register C7LSEMRU release history

Register C7LSEMRU was introduced in BCS21.

BCS33

When you set the office parameter OMINERLANGS to Y, you convert the usage count from CCS to deci-erlangs. This conversion occurs before the count appears. Use the OMSHOW command on the ACTIVE class to display the usage count. The value in the active registers remains in CCS.

BCS30

Software change to provide usage counts in CCS or deci-erlangs.

Associated registers

Registers C7LKSET_C7LSEMRU & C7LKSET_C7LSUNAU associate with register C7LSMERU.

Associated logs

There are no associated logs.

Register C7LSFAIL

CCS7 linkset failure (C7LSFAIL)

Register C7LSFAIL counts links that are out of service.

If the system removes a link from service, the linkset loses all working links and does not transmit messages to the routesets. When this register counts, an alarm occurs. This register collects data in the central control (CC).

Register C7LSFAIL release history

Register C7LSFAIL was introduced in BCS20.

Associated registers

Register C7LSUNAU records when a linkset provides traffic capability to the routesets.

OM group C7LKSET (end)

Associated logs

There are no associated logs.

Register C7LSUNAU

CCS7 linkset unavailable (C7LSUNAU)

Register C7LSUNAU is a usage register. The scan rate is 10 s. Register C7LSUNAU records when the linkset does not transmits messages to the routesets.

When this register counts, an alarm occurs because all links on this linkset fail. Some linksets in the routesets of this linkset are available.

Register C7LSUNAU release history

Register C7LSUNAU was introduced in BCS20.

BCS33

When you set office parameter OMINERLANGS to Y, you convert the usage count from CCS to deci-erlangs. This conversion occurs before the count appears. Use the OMSHOW command on the ACTIVE class. The value in the active registers remains in CCS.

BCS30

Software change to provide usage counts in CCS or deci-erlangs.

Associated registers

Associated registers include C7LKSET_C7LSUNAU
C7LKSET_C7LSEMUR.

Associated logs

There are no associated logs.

OM group C7LPP

OM description

CCS7 Link Peripheral Processor

OM group C7LPP stores link peripheral processor (LPP) information for interframe and intraframe traffic and message size on a Common Channel Signaling 7 (CCS7) link. OM group C7LPP can store message switch (MS), link peripheral processor (LPP), and enhanced LPP (ELPP) information.

An intraframe message has source and destination signaling data links (SDL) in the same frame. An interframe message has different source and destination frames.

OM group C7LPP has a traffic level threshold of 60% to 70% processing capacity for the CCS7 link interface unit (LIU7) and high-speed CCS7 link interface unit (HLIU). C7LPP is turned off when the traffic level exceeds the threshold.

OM group C7LPP is not reported through the Signaling, Engineering, and Administration System (SEAS).

Release history

OM group C7LPP is introduced in STP04.

Registers

The following OM group C7LPP registers display on the MAP terminal as follows:

VALID_FL	NILREG1	NILREG2	NILREG3
IEH5SRX	IEH5STX	IAH5SRX	IAH5STX
IEH1TRX	IEH1TTX	IEA1TRX	IEA1TTX
IAH1TRX	IAH1TTX	IAA1TRX	IAA1TTX
C7L27RX	C7L27TX	C7L43RX	C7L43TX
C7L74RX	C7L74TX	C7L75RX	C7L75TX
C7H1CRX	C7H1CTX	C7H2CRX	C7H2CTX
C7H3CRX	C7H3CTX	C7H4CRX	C7H4CTX

Group structure

OM group C7LPP provides 32 tuples.

Key field:

Controlling entity (MS or LIM)

OM group C7LPP (continued)

Info field:

Card number for the MS controller or the LIM number for the LIM controller

Associated OM groups

OM group C7LPP2

Registers VALIDFL2, LPPSCRX, and LPPSCRX2 are in OM group C7LPP2 because OM group C7LPP has the maximum number of registers. Register VALIDFL2 indicates the validity of the registers in C7LPP2, and registers LPPSCRX and LPPSCRX2 store the LPP information for message type SCCP, User Part, or SNM.

Associated functional groups

Functional group HLIU is associated with OM group C7LPP.

Associated functionality codes

The functionality code associated with OM group C7LPP is shown in the following table.

Functionality	Code
High-speed link interface unit (HLIU)	STPE006

OM group C7LPP (continued)

OM group C7LPP registers for interframe and intraframe traffic measurements

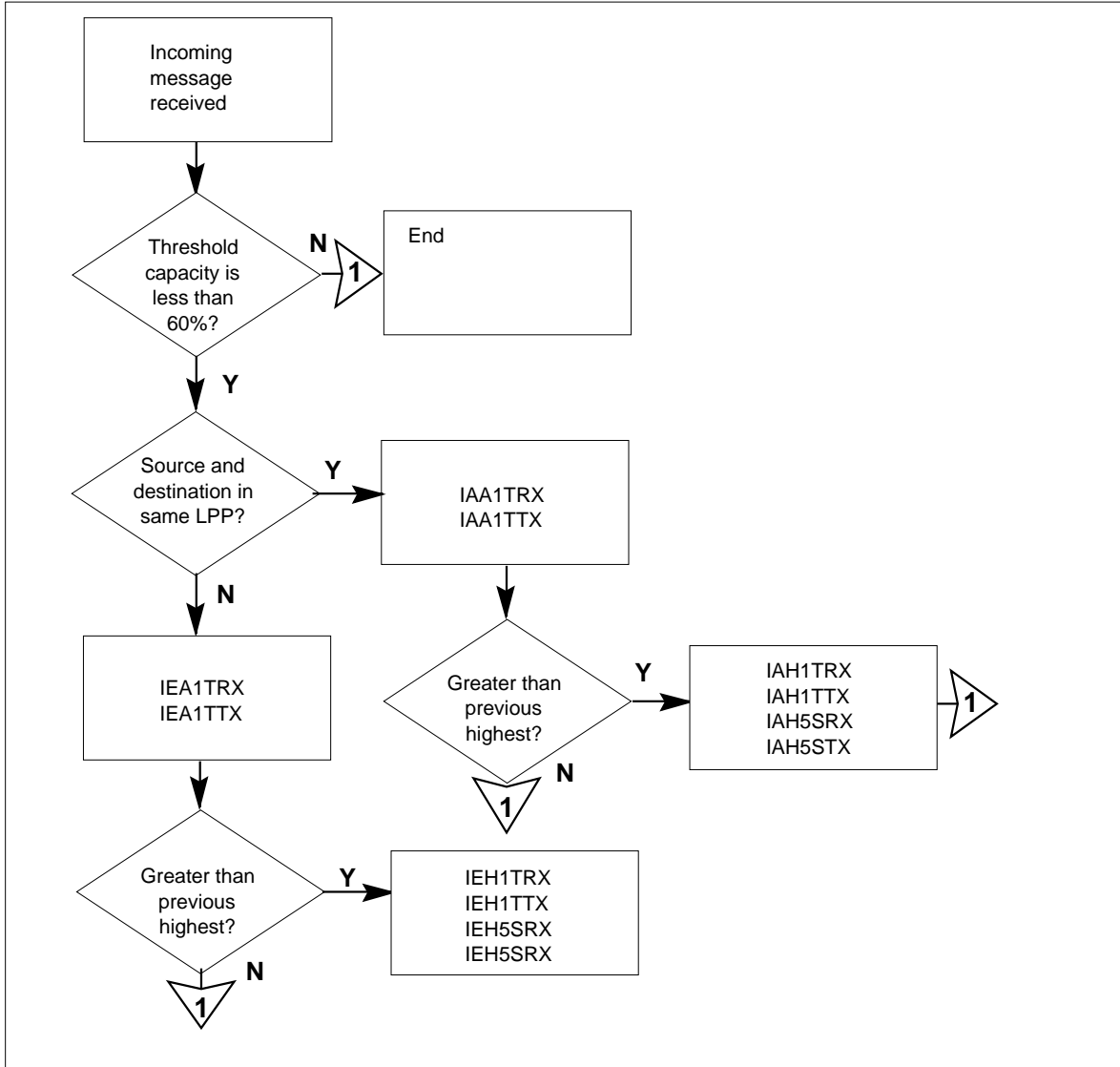

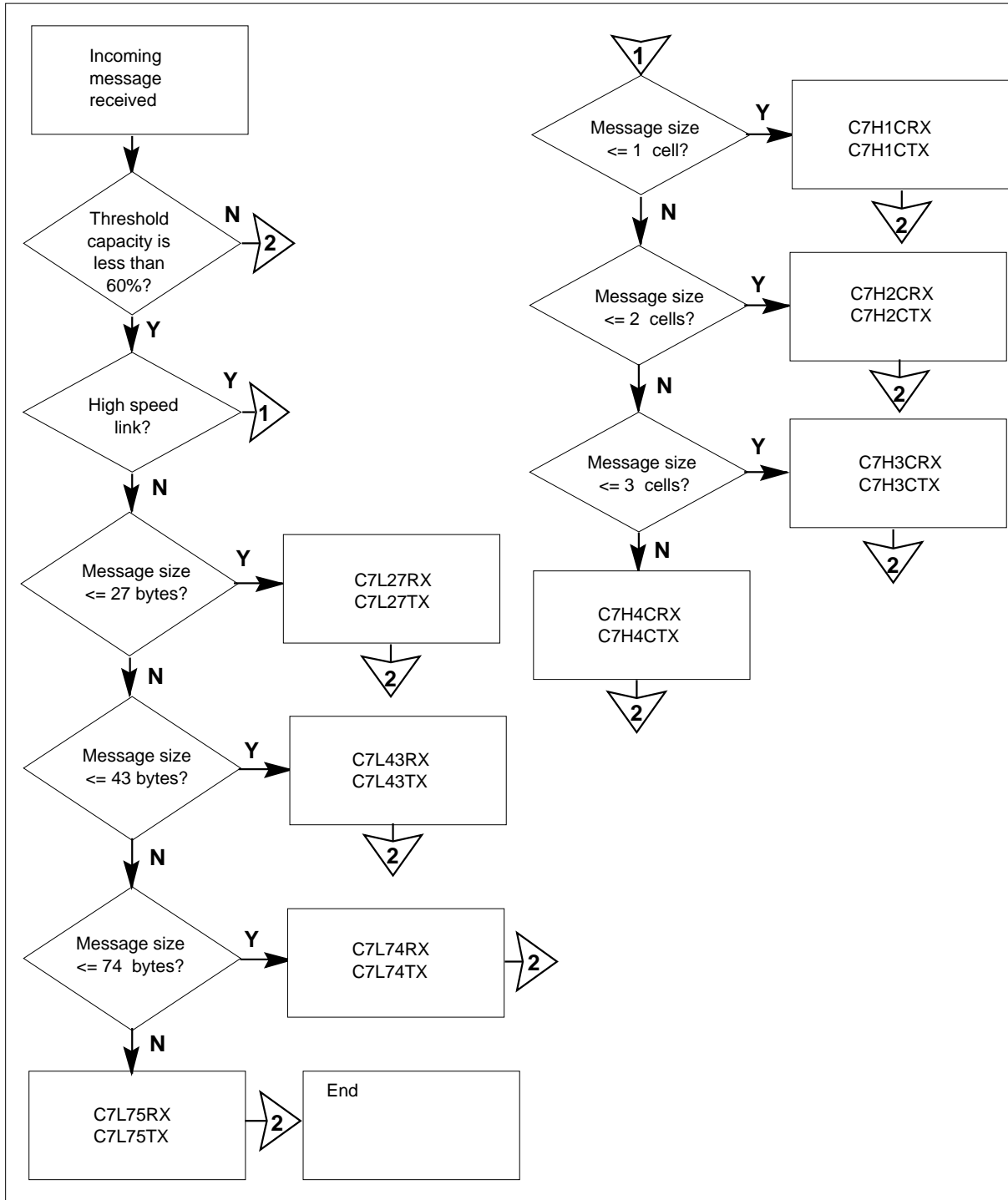
OM group C7LPP (continued)**OM group C7LPP registers for message length measurements**

OM group C7LPP (continued)

Register VALID_FL

Validity of the OM data in table C7LPP

Register VALID_FL indicates the validity of all registers in group C7LPP.

Register VALID_FL release history

Register VALID_FL is introduced in STP04.

Associated registers

All other registers in OM group C7LPP are associated with register VALID_FL. Register VALID_FL indicates the validity of each register. The validation formula is 0 for invalid or 1 for valid.

Associated logs

None

Extension registers

None

Register NILREG1

Nil register 1

Register NILREG1 is a filler to align registers in OM group C7LPP.

Register NILREG1 release history

Register NILREG1 is introduced in STP04.

Associated registers

None

Associated logs

None

Extension registers

None

Register NILREG2

Nil register 2

Register NILREG2 is a filler to align registers in OM group C7LPP.

Register NILREG2 release history

Register NILREG2 is introduced in STP04.

OM group C7LPP (continued)

Associated registers

None

Associated logs

None

Extension registers

None

Register NILREG3

Nil register 3

Register NILREG3 is a filler to align registers in OM group C7LPP.

Register NILREG3 release history

Register NILREG3 is introduced in STP04.

Associated registers

None

Associated logs

None

Extension registers

None

Register IEH5SRX

Incoming interframe traffic highest percent (5 s/24 h)

Register IEH5SRX stores the highest percentage of 5-s incoming interframe traffic within 24 h.

Register IEH5SRX release history

Register IEH5SRX is introduced in STP04.

Associated registers

VALID_FL

VALID_FL indicates the validity of register IEH5SRX. The validation formula range is 0 to 100.

Associated logs

None

OM group C7LPP (continued)

Extension registers

None

Register IEH5STX

Outgoing interframe traffic highest percent (5 s/24 h)

Register IEH5STX stores the highest percentage of 5-s outgoing interframe traffic within 24 h.

Register IEH5STX release history

Register IEH5STX is introduced in STP04.

Associated registers

VALID_FL

VALID_FL indicates the validity of register IEH5STX. The validation formula range is 0 to 100.

Associated logs

None

Register IAH5SRX

Incoming intraframe traffic highest percent (5 s/24 h)

Register IAH5SRX stores the highest percentage of 5-s incoming intraframe traffic within 24 h.

Register IAH5SRX release history

Register IAH5SRX is introduced in STP04.

Associated registers

VALID_FL

VALID_FL indicates the validity of register IAH5SRX. The validation formula range is 0 to 100.

Associated logs

None

Extension registers

None

OM group C7LPP (continued)

Register IAH5STX

Outgoing intraframe traffic highest percent (5 s/24 h)

Register IAH5STX stores the highest percentage of 5-s outgoing intraframe traffic within 24 h.

Register IAH5STX release history

Register IAH5STX is introduced in STP04.

Associated registers

VALID_FL

VALID_FL indicates the validity of register IAH5STX. The validation formula range is 0 to 100.

Associated logs

None

Extension registers

None

Extension registers

None

Register IEH1TRX

Incoming interframe highest percent (1 transfer period per 24 h)

Register IEH1TRX stores the highest percentage of the incoming interframe traffic for one transfer period within 24 h.

Register IEH1TRX release history

Register IEH1TRX is introduced in STP04.

Associated registers

VALID_FL

VALID_FL indicates the validity of register IEH1TRX. The validation formula range is 0 to 100.

Associated logs

None

OM group C7LPP (continued)

Extension registers

None

Register IEH1TTX

Outgoing interframe traffic highest percent (1 transfer period per 24 h)

Register IEH1TTX stores the highest percentage of the outgoing interframe traffic for one transfer period within 24 h.

Register IEH1TTX release history

Register IEH1TTX is introduced in STP04.

Associated registers

VALID_FL

VALID_FL indicates the validity of register IEH1TTX. The validation formula range is 0 to 100.

Associated logs

None

Extension registers

None

Register IEA1TRX

Incoming interframe traffic accumulated percent (1 transfer period)

Register IEA1TRX stores the accumulated percentage of incoming interframe traffic for one transfer period.

Register IEA1TRX release history

Register IEA1TRX is introduced in STP04

Associated registers

VALID_FL

VALID_FL indicates the validity of register IEA1TRX. The validation formula range is 0 to 100.

Associated logs

None

OM group C7LPP (continued)

Extension registers

None

Register IEA1TTX

Outgoing interframe traffic accumulated percent (1 transfer period)

Register IEA1TTX stores the accumulated percentage of outgoing interframe traffic for one transfer period.

Register IEA1TTX release history

Register IEA1TTX is introduced in STP04.

Associated registers

VALID_FL

VALID_FL indicates the validity of register IEA1TTX. The validation formula range is 0 to 100.

Associated logs

None

Extension registers

None

Register IAH1TRX

Incoming intraframe highest percent (1 transfer period per 24 h)

Register IAH1TRX stores the highest percentage of incoming intraframe traffic in one transfer period within 24 h.

Register IAH1TRX release history

Register IAH1TRX is introduced in STP04.

Associated registers

VALID_FL

VALID_FL indicates the validity of register IAH1TRX. The validation formula range is 0 to 100.

Associated logs

None

OM group C7LPP (continued)

Extension registers

None

Register IAH1TTX

Outgoing intraframe highest percent (1 transfer period per 24 h)

Register IAH1TTX stores the highest percentage of outgoing intraframe traffic in one transfer period within 24 h.

Register IAH1TTX release history

Register IAH1TTX is introduced in STP04.

Associated registers

VALID_FL

VALID_FL indicates the validity of register IAH1TTX. The validation formula range is 0 to 100.

Associated logs

None

Extension registers

None

Register IAA1TRX

Incoming intraframe traffic accumulated percent (1 transfer period)

Register IAA1TRX stores the accumulated percentage of incoming intraframe traffic in one transfer period.

Register IAA1TRX release history

Register IAA1TRX is introduced in STP04.

Associated registers

VALID_FL

VALID_FL indicates the validity of register IAA1TRX. The validation formula range is 0 to 100.

Associated logs

None

OM group C7LPP (continued)

Extension registers

None

Register IAA1TTX

Outgoing intraframe traffic accumulated percent (1 transfer period)

Register IAA1TTX stores the accumulated percentage of outgoing intraframe traffic in one transfer period.

Register IAA1TTX release history

Register IAA1TTX is introduced in STP04.

Associated registers

VALID_FL

VALID_FL indicates the validity of register IAA1TTX. The validation formula range is 0 to 100.

Associated logs

None

Extension registers

None

Register C7L27RX

Percent of incoming traffic MSU length equal to or less than 27 bytes (LIU7)

Register C7L27RX stores the total percentage of incoming LIU7 traffic transmitted through a frame in one transfer period. The traffic has a message transfer part (MTP) layer 2 message length of less than or equal to 27 bytes.

Register C7L27RX release history

Register C7L27RX is introduced in STP04.

Associated registers

VALID_FL

VALID_FL indicates the validity of register C7L27RX. The validation formula range is 0 to 100. The validation formula follows.

$$C7L27RX + C7L43RX + C7L74RX + C7L75RX = 100 \text{ or } 0$$

$$C7L27TX + C7L43TX + C7L74TX + C7L75TX = 100 \text{ or } 0$$

OM group C7LPP (continued)

Note: If the frame does not have an LIU7, the sum is 0. If the frame has an LIU7, the sum is 100.

Associated logs

None

Extension registers

None

Register C7L27TX

Percent of outgoing traffic MSU length equal to or less than 27 bytes (LIU7)

Register C7L27TX stores the total percent of outgoing LIU7 traffic transmitted through a frame in one transfer period. The traffic has an MTP layer 2 message length of less than or equal to 27 bytes.

Register C7L27TX release history

Register C7L27TX is introduced in STP04.

Associated registers

VALID_FL

VALID_FL indicates the validity of register C7L27TX. The validation formula range is 0 to 100. The validation formula follows.

$$C7L27RX + C7L43RX + C7L74RX + C7L75RX = 100 \text{ or } 0$$

$$C7L27TX + C7L43TX + C7L74TX + C7L75TX = 100 \text{ or } 0$$

Associated logs

None

Extension registers

None

Register C7L43RX

Percent of incoming traffic MSU length 28 to 43 bytes (LIU7)

Register C7L43RX stores the total percent of incoming LIU7 traffic transmitted through a frame in one transfer period. The traffic has an MTP

OM group C7LPP (continued)

layer 2 message length of greater than or equal to 28 bytes and less than or equal to 43 bytes.

Register C7L43RX release history

Register C7L43RX is introduced in STP04.

Associated registers

VALID_FL

VALID_FL indicates the validity of register C7L43RX. The validation formula range is 0 to 100. The validation formula follows.

$$C7L27RX + C7L43RX + C7L74RX + C7L75RX = 100 \text{ or } 0$$

$$C7L27TX + C7L43TX + C7L74TX + C7L75TX = 100 \text{ or } 0$$

Associated logs

None

Extension registers

None

Register C7L43TX

Percent of outgoing traffic MSU length 28 to 43 bytes (LIU7)

Register C7L43TX stores the total percent of outgoing LIU7 traffic transmitted through a frame in one transfer period. The traffic has an MTP layer 2 message length of greater than or equal to 28 bytes and less than or equal to 43 bytes.

Register C7L43TX release history

Register C7L43TX is introduced in STP04.

Associated registers

VALID_FL

VALID_FL indicates the validity of register C7L43TX. The validation formula range is 0 to 100. The validation formula follows.

$$C7L27RX + C7L43RX + C7L74RX + C7L75RX = 100 \text{ or } 0$$

$$C7L27TX + C7L43TX + C7L74TX + C7L75TX = 100 \text{ or } 0$$

Associated logs

None

OM group C7LPP (continued)

Extension registers

None

Register C7L74RX

Percent of incoming traffic MSU length 43 to 74 bytes (LIU7)

Register C7L74RX stores the total percent of incoming LIU7 traffic transmitted through a frame in one transfer period. The traffic has an MTP layer 2 message length of greater or equal to 43 bytes and less than or equal to 74 bytes.

Register C7L74RX release history

Register C7L74RX is introduced in STP04.

Associated registers

VALID_FL

VALID_FL indicates the validity of register C7L74RX. The validation formula range is 0 to 100. The validation formula follows.

$$C7L27RX + C7L43RX + C7L74RX + C7L75RX = 100 \text{ or } 0$$

$$C7L27TX + C7L43TX + C7L74TX + C7L75TX = 100 \text{ or } 0$$

Associated logs

None

Extension registers

None

Register C7L74TX

Percent of outgoing traffic MSU length 43 to 74 bytes (LIU7)

Register C7L74TX stores the total percent of outgoing LIU7 traffic transmitted through a frame in one transfer period. The traffic has an MTP layer 2 message length of greater or equal to 43 bytes and less than or equal to 74 bytes.

Register C7L74TX release history

Register C7L74TX is introduced in STP04.

Associated registers

VALID_FL

OM group C7LPP (continued)

VALID_FL indicates the validity of register C7L74TX. The validation formula range is 0 to 100. The validation formula follows.

$$C7L27RX + C7L43RX + C7L74RX + C7L75RX = 100 \text{ or } 0$$

$$C7L27TX + C7L43TX + C7L74TX + C7L75TX = 100 \text{ or } 0$$

Associated logs

None

Extension registers

None

Register C7L75RX

Percent of incoming traffic MSU length of greater than or equal to 75 bytes (LIU7)

Register C7L75RX stores the total percent of incoming LIU7 traffic transmitted through a frame in one transfer period. The traffic has an MTP layer 2 message length of greater or equal to 75 bytes.

Register C7L75RX release history

Register C7L75RX is introduced in STP04.

Associated registers

VALID_FL

VALID_FL indicates the validity of register C7L75RX. The validation formula range is 0 to 100. The validation formula follows.

$$C7L27RX + C7L43RX + C7L74RX + C7L75RX = 100 \text{ or } 0$$

$$C7L27TX + C7L43TX + C7L74TX + C7L75TX = 100 \text{ or } 0$$

Associated logs

None

Extension registers

None

Register C7L75TX

Percent of outgoing traffic MSU length greater than or equal to 75 bytes (LIU7)

OM group C7LPP (continued)

Register C7L75TX stores the total percent of outgoing LIU7 traffic transmitted through a frame in one transfer period. The traffic has an MTP layer 2 message length of greater or equal to 75 bytes.

Register C7L75TX release history

Register C7L75TX is introduced in STP04.

Associated registers

VALID_FL

VALID_FL indicates the validity of register C7L75TX. The validation formula range is 0 to 100. The validation formula follows.

$$C7L27RX + C7L43RX + C7L74RX + C7L75RX = 100 \text{ or } 0$$

$$C7L27TX + C7L43TX + C7L74TX + C7L75TX = 100 \text{ or } 0$$

Associated logs

None

Extension registers

None

Register C7H1CRX

Percent of incoming traffic MSU length less than or equal to one asynchronous transfer mode (ATM) cell (HLIU)

Register C7H1CRX stores the total percent of incoming HLIU traffic transmitted through a frame in one transfer period. The traffic has a message length of less than or equal to one asynchronous transfer mode (ATM) cell.

Register C7H1CRX release history

Register C7H1CRX is introduced in STP04.

Associated registers

VALID_FL

VALID_FL indicates the validity of register C7H1CRX. The validation formula range is 0 to 100. The validation formula follows.

$$C7H1CRX + C7H2CRX + C7H3CRX + C7H4CRX = 100 \text{ or } 0$$

$$C7H1CTX + C7H2CTX + C7H3CTX + C7H4CTX = 100 \text{ or } 0$$

OM group C7LPP (continued)

Note: If the frame does not have an LIU7, the sum is 0. If the frame has an LIU7, the sum is 100.

Associated logs

None

Extension registers

None

Register C7H1CTX

Percent of outgoing traffic MSU length less than or equal to 1 ATM cell (HLIU)

Register C7H1CTX stores the total percentage of outgoing HLIU traffic through a frame in one transfer period. The traffic has a message length of less than or equal to one ATM cell.

Register C7H1CTX release history

Register C7H1CTX is introduced in STP04.

Associated registers

VALID_FL

VALID_FL indicates the validity of register C7H1CTX. The validation formula range is 0 to 100. The validation formula follows.

$$C7H1CRX + C7H2CRX + C7H3CRX + C7H4CRX = 100 \text{ or } 0$$

$$C7H1CTX + C7H2CTX + C7H3CTX + C7H4CTX = 100 \text{ or } 0$$

Associated logs

None

Extension registers

None

Register C7H2CRX

Percent of incoming traffic MSU length 1 to 2 ATM cells (HLIU)

OM group C7LPP (continued)

Register C7H2CRX stores the total percent of incoming HLIU traffic transmitted through a frame in one transfer period. The traffic has a message length of greater than one ATM cell and less than or equal to two ATM cells.

Register C7H2CRX release history

Register C7H2CRX is introduced in STP04.

Associated registers

VALID_FL

VALID_FL indicates the validity of register C7H2CRX. The validation formula range is 0 to 100. The validation formula follows.

$$C7H1CRX + C7H2CRX + C7H3CRX + C7H4CRX = 100 \text{ or } 0$$

$$C7H1CTX + C7H2CTX + C7H3CTX + C7H4CTX = 100 \text{ or } 0$$

Associated logs

None

Extension registers

None

Register C7H2CTX

Percent of outgoing traffic MSU length 1 to 2 ATM cells (HLIU)

Register C7H2CTX stores the total percent of outgoing HLIU traffic transmitted through a frame in one transfer period. The traffic has a message length of greater than one ATM cell and less than or equal to two ATM cells.

Register C7H2CTX release history

Register C7H2CTX is introduced in STP04.

Associated registers

VALID_FL

VALID_FL indicates the validity of register C7H2CTX. The validation formula range is 0 to 100. The validation formula follows.

$$C7H1CRX + C7H2CRX + C7H3CRX + C7H4CRX = 100 \text{ or } 0$$

$$C7H1CTX + C7H2CTX + C7H3CTX + C7H4CTX = 100 \text{ or } 0$$

OM group C7LPP (continued)

Associated logs

None

Extension registers

None

Register C7H3CRX

Percent of incoming traffic MSU length 2 to 3 ATM cells (HLIU)

Register C7H3CRX stores the total percent of incoming HLIU traffic transmitted through a frame in one transfer period. The traffic has a message length of greater than two ATM cells and less than or equal to three ATM cells.

Register C7H3CRX release history

Register C7H3CRX is introduced in STP04.

Associated registers

VALID_FL

VALID_FL indicates the validity of register C7H3CRX. The validation formula range is 0 to 100. The validation formula follows.

$$C7H1CRX + C7H2CRX + C7H3CRX + C7H4CRX = 100 \text{ or } 0$$

$$C7H1CTX + C7H2CTX + C7H3CTX + C7H4CTX = 100 \text{ or } 0$$

Associated logs

None

Extension registers

None

Register C7H3CTX

Percent of outgoing traffic MSU length 2 to 3 ATM cells (HLIU)

Register C7H3CTX stores the total percent of outgoing HLIU traffic transmitted through a frame in one transfer period. The traffic has a message length of greater than two ATM cells and less than or equal to three ATM cells.

Register C7H3CTX release history

Register C7H3CTX is introduced in STP04.

OM group C7LPP (continued)

Associated registers

VALID_FL

VALID_FL indicates the validity of register C7H3CTX. The validation formula range is 0 to 100. The validation formula follows.

$$C7H1CRX + C7H2CRX + C7H3CRX + C7H4CRX = 100 \text{ or } 0$$

$$C7H1CTX + C7H2CTX + C7H3CTX + C7H4CTX = 100 \text{ or } 0$$

Associated logs

None

Extension registers

None

Register C7H4CRX

Percent of incoming traffic MSU length greater than 3 ATM cells (HLIU)

Register C7H4CRX stores the total percent of incoming HLIU traffic transmitted through a frame in one transfer period. The traffic has a message length of greater than three ATM cells.

Register C7H4CRX release history

Register C7H4CRX is introduced in STP04.

Associated registers

VALID_FL

VALID_FL indicates the validity of register C7H4CRX. The validation formula range is 0 to 100. The validation formula follows.

$$C7H1CRX + C7H2CRX + C7H3CRX + C7H4CRX = 100 \text{ or } 0$$

$$C7H1CTX + C7H2CTX + C7H3CTX + C7H4CTX = 100 \text{ or } 0$$

Associated logs

None

Extension registers

None

OM group C7LPP (end)

Register C7H4CTX

Percent of outgoing traffic MSU length greater than 3 ATM cells (HLIU)

Register C7H4CTX stores the total percent of incoming HLIU traffic transmitted through a frame in one transfer period. The traffic has a message length of greater than three ATM cells.

Register C7H4CTX release history

Register C7H4CTX is introduced in STP04.

Associated registers

VALID_FL

VALID_FL indicates the validity of register C7H4CTX. The validation formula range is 0 to 100. The validation formula follows.

$$C7H1CRX + C7H2CRX + C7H3CRX + C7H4CRX = 100 \text{ or } 0$$

$$C7H1CTX + C7H2CTX + C7H3CTX + C7H4CTX = 100 \text{ or } 0$$

Associated logs

None

Extension registers

None

OM group C7LPP2

OM description

CCS7 link peripheral processor 2

OM group C7LPP2 stores link peripheral processor (LPP) information related to message type on Common Channel Signaling 7 (CCS7) links.

C7LPP2 has a traffic level threshold of 60% to 70% processing capacity for both the CCS7 link interface unit (LIU7) and high-speed CCS7 link interface unit (HLIU). C7LPP2 is turned off when the traffic level exceeds the threshold.

OM group C7LPP2 is not reported through the Signaling, Engineering, and Administration System (SEAS).

Release history

OM group C7LPP2 is introduced in STP04.

Registers

The following OM group C7LPP2 registers display on the MAP terminal as follows:

VALIDFL2	LPP2NIL1	LP2NIL2	LPP2NIL3
LPPSCRX	LPPSCRX2	LPPSCTX	LPPSCTX2
LPPUPRX	LPPUPRX2	LPPUPTX	LPPUPTX2
LPMTPRX	LPMTPRX2	LPMTPTX	LPMTPTX2

Group structure

OM group C7LPP2 provides 16 tuples.

Key field:

Controlling entity (MS or LIM)

Info field:

Card number for the MS controller or LIM number for the LIM controller

Associated OM groups

OM group C7LPP

Registers VALIDFL2, LPPSCRX, and LPPSCRX2 are in OM group C7LPP2 because OM group C7LPP has the maximum number of registers. Register

OM group C7LPP2 (continued)

VALIDFL2 indicates the validity of the registers in C7LPP2, and registers LPPSCRX and LPPSCRX2 store the LPP information for message type SCCP, User Part., or SNM.

Associated functional groups

The following functional group is associated with OM group C7LPP2:

- HLIU

Associated functionality codes

The functionality code associated with OM group C7LPP2 is shown in the following table.

Functionality	Code
High-speed link interface unit (HLIU)	STPE006

OM group C7LPP2 (continued)

OM group C7LPP2 registers

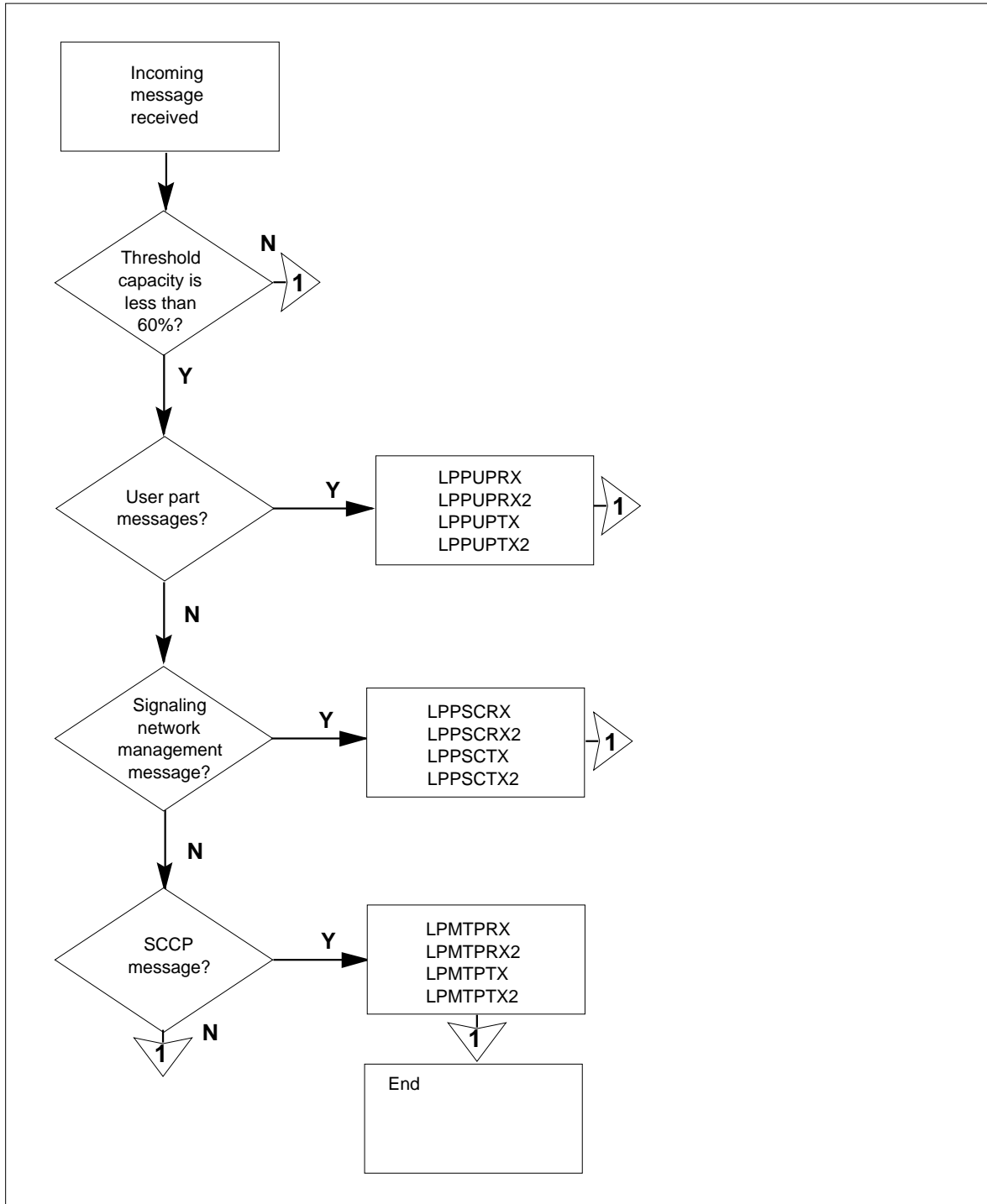

OM group C7LPP2 (continued)

Register VALIDFL2

Validity of OM data in table C7LPP2

Register VALIDFL2 indicates the validity of all registers within OM group C7LPP2.

Register VALIDFL2 release history

Register VALIDFL2 is introduced in STP04.

Associated registers

All registers in table C7LPP2 are associated with register VALIDFL2. VALIDFL2 indicates the validity of each register. The validation formula is 0 for invalid or 1 for valid.

Associated logs

None

Extension registers

None

Register LPP2NIL1

LPP nil register 1 for OM group C7LPP2

Register LPP2NIL1 is a filler to align registers in OM group C7LPP2.

Register LPP2NIL1 release history

Register LPP2NIL1 is introduced in STP04.

Associated registers

None

Associated logs

None

Extension registers

None

Register LP2NIL2

LPP nil register 2 for OM group C7LPP2

Register LP2NIL2 is a filler to align registers in OM group C7LPP2.

OM group C7LPP2 (continued)

Register LP2NIL2 release history

Register LP2NIL2 is introduced in STP04.

Associated registers

None

Associated logs

None

Extension registers

None

Register LPP2NIL3

LPP nil register 3 for OM group C7LPP2

Register LPP2NIL3 is a filler to align registers in OM group C7LPP2.

Register LPP2NIL3 release history

Register LPP2NIL3 is introduced in STP04.

Associated registers

None

Associated logs

None

Extension registers

None

Register LPPSCRX

Incoming SCCP accumulated traffic

Register LPPSCRX stores the number of incoming signaling connection control part (SCCP) messages transmitted through a frame in one transfer period. If the register is longer than the size of the integer, the data is stored in extension register LPPSCRX2.

Register LPPSCRX release history

Register LPPSCRX is introduced in STP04.

Associated registers

VALIDFL2

OM group C7LPP2 (continued)

VALIDFL2 indicates the validity of register LPPSCRX.

Associated logs

None

Extension registers

LPPSCRX2

Register LPPSCTX

Outgoing SCCP accumulated traffic

Register LPPSCTX stores the number of outgoing SCCP messages transmitted through a frame in one transfer period. If the register is longer than the size of the integer, the data is stored in extension register LPPSCTX2.

Register LPPSCTX release history

Register LPPSCTX is introduced in STP04.

Associated registers

VALIDFL2

VALIDFL2 indicates the validity of register LPPSCTX.

Associated logs

None

Extension registers

LPPSCTX2

Register LPPUPRX

Incoming user part accumulated traffic

Register LPPUPRX stores the number of incoming user part messages transmitted through a frame in one transfer period. If the register is longer than the size of the integer, the data is stored in extension register LPPUPRX2.

Register LPPUPRX release history

Register LPPUPRX is introduced in STP04.

Associated registers

VALIDFL2

VALIDFL2 indicates the validity of register LPPUPRX.

OM group C7LPP2 (continued)

Associated logs

None

Extension registers

LPPUPRX2

Register LPPUPTX

Outgoing user part accumulated traffic

Register LPPUPRX stores the number of outgoing user part messages transmitted through a frame in one transfer period. If the register is longer than the size of the integer, the data is stored in extension register LPPUPTX2.

Register LPPUPTX release history

Register LPPUPTX is introduced in STP04.

Associated registers

VALIDFL2

VALIDFL2 indicates the validity of register LPPUPTX.

Associated logs

None

Extension registers

LPPUPTX2

Register LPMTPRX

Incoming MTP accumulated traffic

Register LPMTPRX stores the number of incoming signaling network management (SNM) messages transmitted through a frame in one transfer period. If the register is longer than the size of the integer, the data is stored in extension register LPMTPRX2.

Register LPMTPRX release history

Register LPMTPRX is introduced in STP04.

Associated registers

VALIDFL2

VALIDFL2 indicates the validity of register LPMTPRX.

OM group C7LPP2 (end)

Associated logs

None

Extension registers

LPMTPRX2

Register LPMTPTX

Outgoing MTP accumulated traffic

Register LPMTPTX stores the number of outgoing SNM messages transmitted through a frame in one transfer period. If the register is longer than the size of the integer, the data is stored in extension register LPMTPTX2.

Register LPMTPTX release history

Register LPMTPTX is introduced in STP04.

Associated registers

VALIDFL2

VALIDFL2 indicates the validity of register LPMTPRX.

Associated logs

None

Extension registers

LPMTPTX2

OM group C7MTP

OM description

CCS7 message transfer part (C7MTP)

The OM group C7MTP counts message signal units (MSU) that a Common Channel Signaling 7 (CCS7) message transfer part (MTP) discards. The OM group C7MTP is part of a signal transfer point (STP). Two registers count discarded MSUs. The system discards MSUs because the system cannot determine the type of message. The system also discards MSUs because the destination point code is not in the routing tables for that office.

Use OM group C7MTP in the Signaling Engineering Administration System (SEAS) for CCS7 offices. Data in the C7MTP transfers to the signaling engineering administration controller (SEAC) for use in SEAS. For the SEAC to collect the correct data, Table OMACC defines three classes. Table OMACC must define three classes to accumulate the required 30-min, 60-min and 24-h collection periods.

The Group Structure section describes how to modify tables OFCOPT and OFCENG. The SEAC requires 5-min reports.

Release history

The OM group C7MTP was introduced in BCS28.

BCS36

Register measurements apply when the user defines the class as active. When users define the class as holding, registers C7PHDYNT, C7PHDYWT, C7XSDYNT, and C7XSDYWT provide totals. The registers do not provide averages.

BCS32

The following registers were introduced:

- C7XSDYWT
- C7XSDYNT
- C7PHDYWT
- C7PHDYNT
- C7GTT95
- C7NGTT95
- C7SMPWT1
- C7SMPWT2

OM group C7MTP (continued)

- C7SMPNT1
- C7SMPNT2

Registers

The OM group C7MTP registers appear on the MAP terminal as follows:

C7MSIDPC	C7MSISIO	C7XSDYWT	C7XSDYNT
C7PHDYWT	C7PHDYNT	C7GTT95	C7NGTT95
C7SMPWT1	C7SMPWT2	C7SMPNT1	C7SMPNT2

Group structure

The OM group C7MTP provides one tuple for each STP.

Key field:

There is no key field.

Info field:

There is no information field.

The SEAC OM collection requires the following table modifications:

- Add SEAS_30M, SEAS_60M, and SEAS_24H to table OMACC.
- Add group C7MTP and fields C7MSIDPC and C7MSISIO to each of the three classes.
- Set OMXFR to X15 in table OFCENG.
- Set OMHISTORYON to Y in table OFCOPT.

Associated OM groups

Use the OM groups C7LINK1, C7LINK2, C7LINK3, and C7SCCP in SEAS to provide performance measurements for CCS7 offices.

Associated functional groups

The following functional groups associate with OM group C7MTP:

- Signaling Engineering Administration System (SEAS)
- Signaling engineering administration controller (SEAC)
- CCS7
- Signal Transfer Point (STP)

OM group C7MTP (continued)

Associated functionality codes

The functionality codes for OM group C7MTP appear in the following table.

Functionality	Code
STP SEAS	NTX835AA
STP Operations	NTX833AA

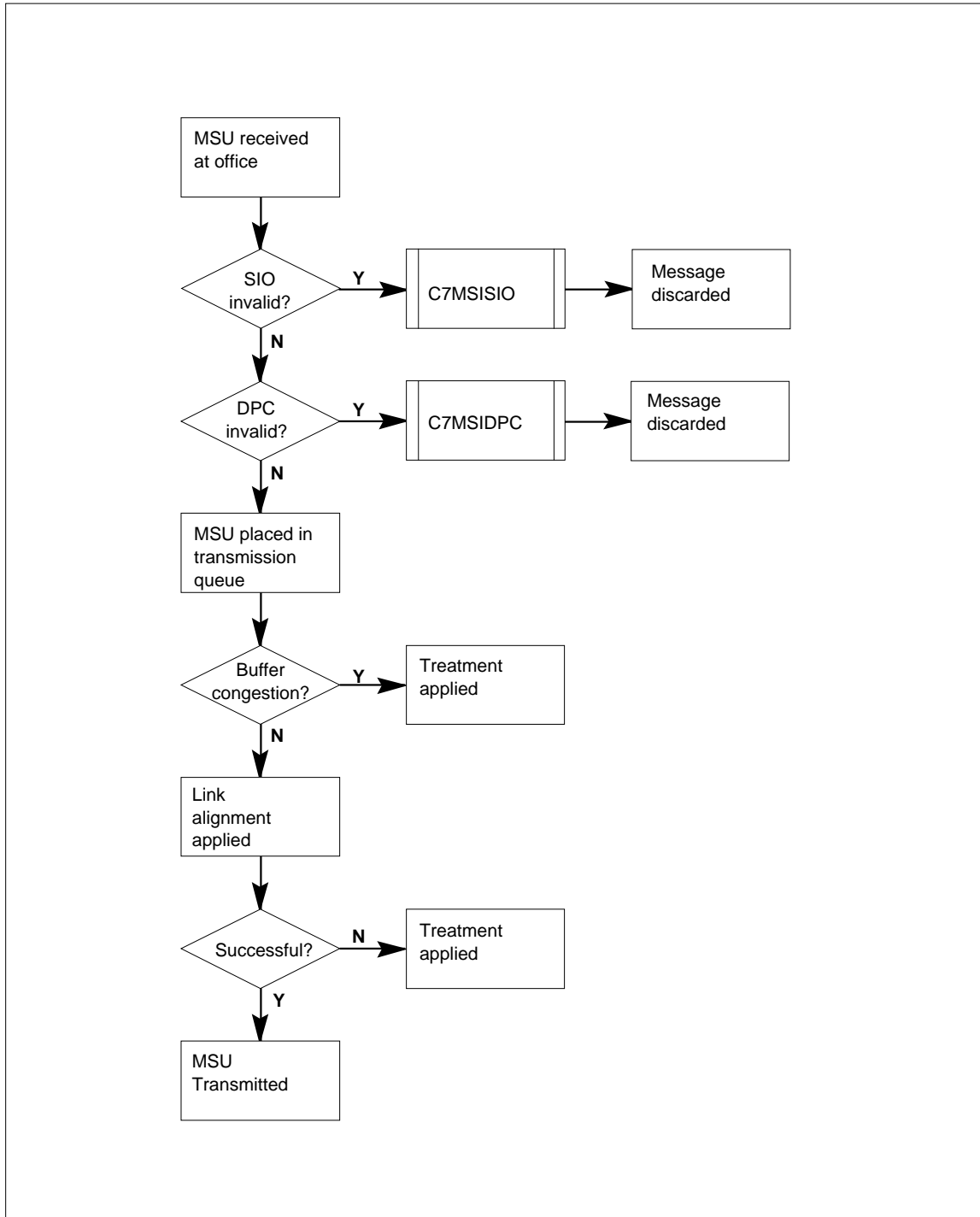
OM group C7MTP (continued)**OM group C7MTP registers**

OM group C7MTP (continued)

Register C7GTT95

Number of 95th percentile tests that failed for MSUs that require global title translation (GTT)

Register C7GTT95 counts the number of MSUs sampled that have processing handling delays. These delays are above the 95th-percentile requirement for MSUs that have GTT.

The processing handling delay is the interval that starts when the STP receives the last bit of a message. The STP receives this message from the incoming signaling link. The interval ends when the message reaches the output signaling link control buffer.

Register C7GTT95 release history

Register C7GTT95 was introduced in BCS32.

Associated registers

There are no associated registers.

Associated logs

There are no associated logs.

Register C7MSIDPC

CCS7 MSU invalid destination point code (C7MSIDPC)

Register C7MSIDPC counts MSUs that the system discards at an STP. The system discards MSUs because the destination point code (DPC) is not in the datafill of the routing tables for the node.

Register C7MSIDPC release history

Register C7MSIDPC was introduced in BCS28.

Associated registers

Register C7MSIDPC associates with MSINVDPC in SEAS.

Associated logs

There are no associated logs.

Register C7MSISIO

CCS7 MSU invalid service information octet (C7MSISIO)

OM group C7MTP (continued)

Register C7MSISIO counts MSUs that the system discards at an STP. The system discards MSUs because the service information octet (SIO) cannot determine the type of message.

Register C7MSISIO release history

Register C7MSISIO was introduced in BCS28.

Associated registers

Register C7MSISIO corresponds to MSINVSIO in SEAS.

Associated logs

There are no associated logs.

Register C7NGTT95

Number of 95th percentile tests that failed for MSUs that do not require global title translation (GTT)

Register C7NGTT95 counts the number of MSUs sampled that have processing handling delays. These delays are above the 95th-percentile requirement for MSUs that do not have GTT.

Register C7NGTT95 release history

Register C7NGTT95 was introduced in BCS32.

Associated registers

There are no associated registers.

Associated logs

There are no associated logs.

Register CYPHDYNT

Average processor handling delay for MSUs that require global title translation (C7PHDYNT)

Register C7PHDYNT records the average processing handling delay for MSUs that do not require global title translation (GTT).

The MSU sampling rate is once every 10 seconds. The register reports the average processing handling delay in milliseconds.

Register CYPHDYNT release history

The register CYPHDYNT was introduced in BCS32.

OM group C7MTP (continued)

BCS36

Register measurements apply when the user defines class as active. When users define the class as holding, register C7PHDYNT provides totals. The register does not provide averages.

Associated registers

There are no associated registers.

Associated logs

There are no associated logs.

Register C7PHDYWT

Average processor handling delay for MSUs that require global title translation (GTT)

The register C7PHDYWT records the average processing handling delay for MSUs that require GTT.

The MSU sampling rate is one time every 10 s. The register reports the average processing handling delay in milliseconds.

Register CYPHDYWT release history

Register CYPHDYWT was introduced in BCS32.

BCS36

Register measurements apply when the user defines the class as active. When users define the class as holding, register C7PHDYWT provides totals. This register does not provide averages.

Associated registers

There are no associated registers.

Associated logs

There are no associated logs.

Register C7SMPNT1

Number of MSUs sampled for cross-STP and processor handling delay measurements that did not require global title translation (C7SMPNT1)

Register C7SMPNT1 records the number of MSUs sampled for cross-STP and processor handling delay measurements. These sampled MSUs do not have GTT.

OM group C7MTP (continued)

Cross-STP delay is the interval that starts when the STP receives the last bit of a message. The STP receives this message from the incoming signaling link. The interval ends when the STP transmits the last bit of the message on the outgoing signaling link.

Register C7SMPNT1 release history

Register C7SMPNT1 was introduced in BCS32

Associated registers

There are no associated registers.

Associated logs

There are no associated logs.

Extension Registers

Register C7SMPNT2 is an extension register.

Register C7SMPWT1

Number of MSUs sampled for cross-STP and processor handling delay measurements that require global title translation (C7SMWT1)

Register C7SMPWT1 records the number of MSUs sampled for average cross-STP and processor handling delay measurements. These sampled MSUs have GTT.

Register C7SMPWT1 release history

Register C7SMPWT1 was introduced in BCS32.

Associated registers

There are no associated registers.

Associated logs

There are no associated logs.

Extension registers

Register C7SMPWT2 is an extension register.

Register C7XSDYNT

Average cross-STP delay for MSUs that do not require global title translation (C7XSDYNT)

Register C7XSDYNT records the average cross-STP delay for MSUs that do not have GTT.

OM group C7MTP (end)

The MSU sampling rate is one time every 10 s. The register reports the average cross-STP delay in milliseconds.

Register C7XSDYNT release history

Register C7XSDYNT was introduced in BCS32.

BCS36

Register measurements apply when the user defines the class as active. When users define the class as holding, register C7XSDYNT provides totals. This register does not provide averages.

Associated registers

There are no associated registers.

Associated logs

There are no associated logs.

Register C7XSDYWT

Average cross-STP delay for MSUs that require global title translation (C7XSDYWT)

The register C7XSDYWT records the average cross-STP delay for MSUs that have GTT.

The MSU sampling rate is one time every 10 s. The register reports average cross-STP delay in milliseconds.

Register C7XSDYWT release history

Register C7XSDYWT was introduced in BCS32.

BCS36

Register measurements apply when the user defines the class as active. When users define the class as holding, register C7XSDYWT provides totals. This register does not provide averages.

Associated registers

There are no associated registers.

Associated logs

There are no associated logs.

OM group C7MTPRES

OM description

MTP Restart (C7MTPRES)

The OM group C7MTPRES counts the number of Message Transfer Part (MTP) Restart procedures initiated in the previous hour.

The OM group C7MTPRES register counts MTP Restarts for the following procedures:

- partial restart procedure
- full restart procedure
- adjacent restart procedure
- unexpected traffic restart message (TRM) procedure

Release history

The OM group C7MTPRES was introduced in TL05 and STP03.

Registers

The OM group C7MTPRES registers appear on the MAP terminal as follows:



RESPARCT	RESFULCT	RESADJCT	RESUNXCT
----------	----------	----------	----------

Group structure

The OM group C7MTPRES

Key field:

There is no key field.

Info field:

There is no information field.

Associated OM groups

There are no associated OM groups.

OM group C7MTPRES (continued)

Associated functional groups

The following functional groups associate with OM group C7MTPRES:

- Common Channel Signaling 7 (CCS7)
- Signaling Transfer Point (STP)
- Service Switching Point (SSP)

Associated functionality codes

The functionality codes for OM group C7MTPRES appear in the following table.

Functionality	Code
STP SEAS	STPS0001
STP Operations	STP0001

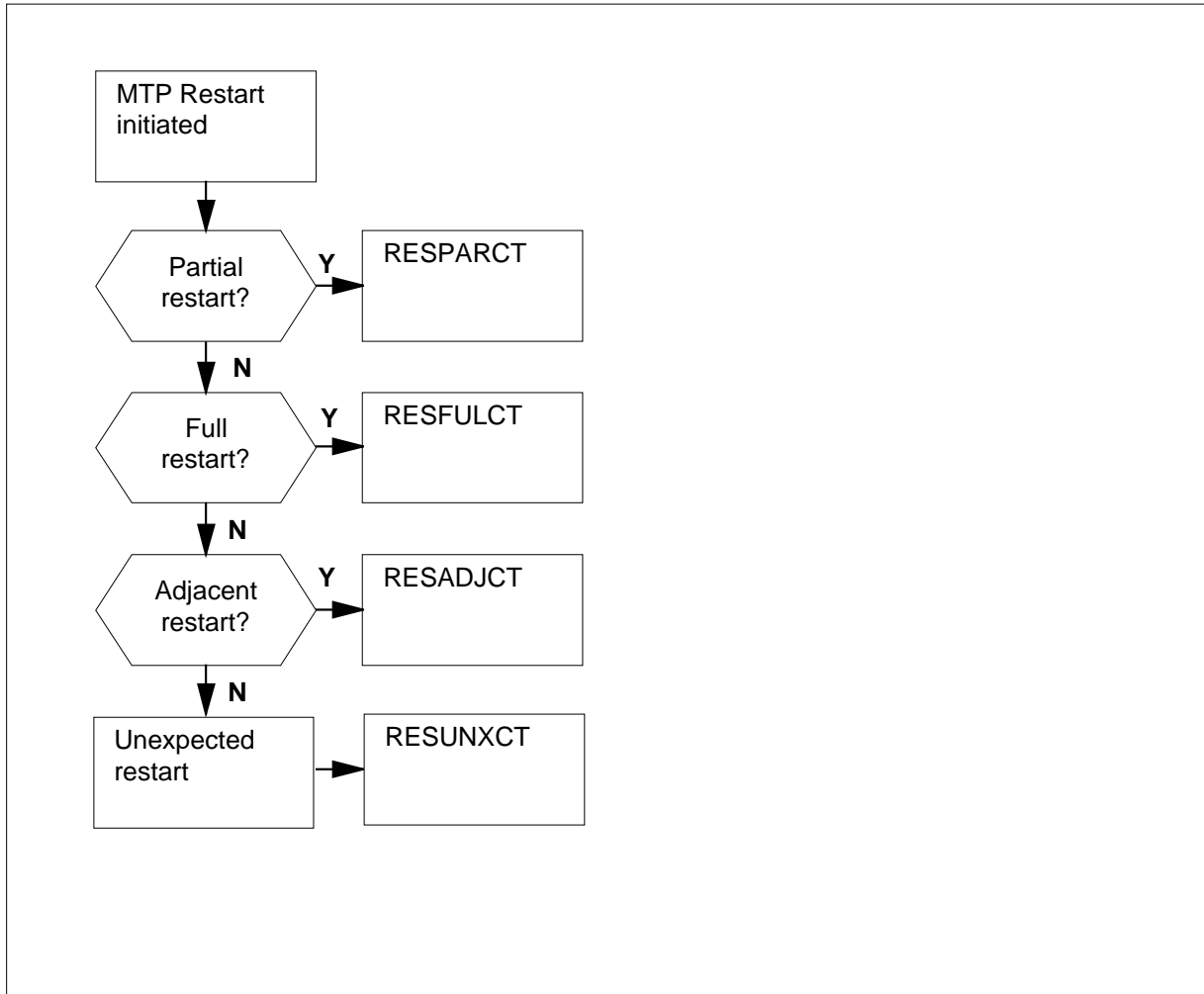
OM group C7MTPRES (continued)**OM group C7MTPRES registers****Register RESADJCT**

restart adjacent count (RESADJCT)

Register RESADJCT release history

Register RESADJCT was introduced in TL05 and STP03.

Register RESADJCT counts the number of adjacent restarts that the system initiated in the last hour.

Associated registers

There are no associated registers.

OM group C7MTPRES (continued)

Associated logs

The system generates log CCS145 when the system initiates an adjacent restart procedure.

Extension registers

There are no extension registers.

Register RESFULCT

restart full count (RESFULCT)

Register RESFULCT release history

Register RESFULCT was introduced in TL05 and STP03.

Register RESFULCT counts the number of full restarts that the system initiated in the last hour.

Associated registers

There are no associated registers.

Associated logs

The system generates log CCS145 when the system initiates a full restart procedure.

Extension registers

There are no extension registers.

Register RESPARCT

restart partial count (RESPARCT)

Register RESPARCT release history

Register RESPARCT was introduced in TL05 and STP03.

Register RESPARCT counts the number of partial restarts that the system initiated in the last hour.

Associated registers

There are no associated registers.

Associated logs

The system generates log CCS145 when the system initiates a partial restart procedure.

OM group C7MTPRES (end)

Extension registers

There are no extension registers.

Register RESUNXCT

restart unexpected TRM count (RESUNXCT)

Register RESUNXCT release history

Register RESUNXCT was introduced in TL05 and STP03.

Register RESUNXCT counts the number of unexpected TRM restarts that the system initiated in the last hour.

Associated registers

There are no associated registers.

Associated logs

The system generates log CCS145 when the system initiates an unexpected restart procedure.

Extension registers

There are no extension registers.

OM group C7ROUTE

OM description

CCS7 route (C7ROUTE)

The OM group C7ROUTE describes the performance and use of Common Channel Signaling 7 (CCS7) routes.

Message routing is based on the address and link selector information that signaling messages provide. This information sets out a routeset. The routeset describes all the signaling paths or routes, linksets, and links in the linkset. The system uses these paths and links to route this message to a destination.

Routeset management determines how stable a route is to transmit messages. If acceptable routing is available, the system selects an in-service link from the linkset. If the route not acceptable, the system examines other routes. The system examines other routes until the system finds an in-service link, or until the system cannot find other routes.

Each route in a routeset has a transfer state that describes the ability of the signaling network to carry messages to the destination. The following transfer states occur:

- transfer allowed (TFA), routing is available
- transfer prohibited (TFP), routing is not available
- transfer restricted (TFR), routing is available at a lower level of service

Note: The Japan Public Network (JPN) only handles TFA and TFP messages. The JPN does not accept TFR messages.

The TFA, TFP, and TFR are the result of forced rerouting or controlled rerouting. When a route to a destination fails, the system reroutes a message to another available route. An indication that a route failed arrives from the remote signaling transfer point of a linkset as a TFP signal. This procedure is forced rerouting. The system determines another route and diverts traffic to that route.

When the system restores a route, messages return to that route from the other route. This procedure is controlled rerouting. An indication of a restored route arrives from the remote signaling transfer point as a TFA signal. The system performs controlled rerouting when a route is restricted because of a lower level of service. A TFR indicates this condition. Controlled rerouting buffers the following traffic into buffers that are not permanent. The system determines other routes. Traffic clears out of the old route. The system sends the buffered traffic to the new route.

OM group C7ROUTE (continued)

Remote congestion information is also received over a route. The system informs the user parts of the congestion level. Transfer controlled (TFC) messages on separate routes report remote congestion. Congestion on one route in a routeset indicates congestion on all routes. An indication of this congestion occurs because the system distributes traffic between signaling transfer points (STP). To alleviate route congestion, the system sends a routeset congestion (RSC) test message on one of the routes. This message has a priority of one less than the remote congestion value. If this message does not generate another TFC from a remote location, the system assumes that congestion decreased.

The OM group C7ROUTE reports for the common channel signalling routes. These routes associate with the first 1024 routesets in the C7RTESET table. The OM group C7ROUTE2 reports the last 1023 routesets.

Note: The Japan public network (JPN) uses a different procedure to clear route congestion than the procedure in the preceding paragraph. The JPN does not send RSC test messages. When the JPN receives route congestion information in a TFC message, the system sets a timer. After 90 s the congestion condition clears automatically.

Release history

The OM group C7ROUTE was introduced in BCS20.

CSP04

The OM group C7ROUTE changed to show that this group reports on the first 1024 routesets in the C7RTESET table.

BCS35

For the Japan public network, the system increases registers C7TFA and C7TFP. The system increases these registers one time for each route that a destination point code (DPC) identifies. The DPC is in the TFA or the TFP messages. This increase occurs for affected route states.

A single DPC can identify more than one route. The TFA and the TFP messages can have a maximum of 13 DPCs. The DPCs identify one or more routes.

Registers C7XTFA, C7XTFP, and C7XTFR were introduced to include counts for TFA, TFR, and TFP messages. A CCS7 node receives these messages. This node is from remote signaling points entered as partial-point-code (PPC) routes. These registers only increase if enhanced cluster routing (ECR) is active. The PPC routing, also known as cluster routing, requires knowledge of only part of the point code.

OM group C7ROUTE (continued)

BCS33

You can convert registers C7RTUNAU from hundred call seconds (CCS) to deci-erlangs before the count appears. Use the OMSHOW command on the ACTIVE class.

BCS30

Software change to provide usage counts in CCS or deci-erlangs.

BCS21

Registers C7TFC0, C7TFC1, C7TFC2, C7TFC3, C7TFA, C7TFR, C7TFP, C7CNTRER, and C7FRCRER activate.

BCS20

Registers C7TFC0, C7TFC1, C7TFC2, C7TFC3, C7TFA, C7TFR, C7TFP, C7CNTRER, and C7FRCRER zeroed.

Registers

The OM group C7ROUTE registers appear on the MAP terminal as follows:

C7RTUNAU	C7TFA	C7TFR	C7TFP
C7TFC0	C7TFC1	C7TFC2	C7TFC3
C7CNTRER	C7FRCRER	C7XTFA	C7XTFR
C7XTFP			

Group structure

The OM group C7ROUTE provides one tuple for each key.

Key field:

C7_ROUTESET-NUMBER, a number in the range 0 to 1024. This number is an index in table C7RTESET

Info field:

C7ROUTE_OMINFO

Associated OM groups

The OM groups C7LINK1 and C7LINK2 track link availability and link use.

The OM group C7LKSET tracks the performance and use of a linkset.

The OM group C7RTESET tracks routeset availability.

OM group C7ROUTE (continued)

The OM group C7ROUTE2 associates with the OM group C7ROUTE. The OM group C7ROUTE collects the same information as the C7ROUTE group. The OM group C7ROUTE2 reports on the last 1023 routesets.

Associated functional groups

There are no associated functional groups.

Associated functionality codes

The functionality codes for OM group C7ROUTE appear in the following table.

Functionality	Code
Remote Line Module	NTX023AB
CCS7 MTP/SCCP	NTX041AB
International Switching Center—Basic	NTX300AA

OM group C7ROUTE (continued)

OM group C7ROUTE registers

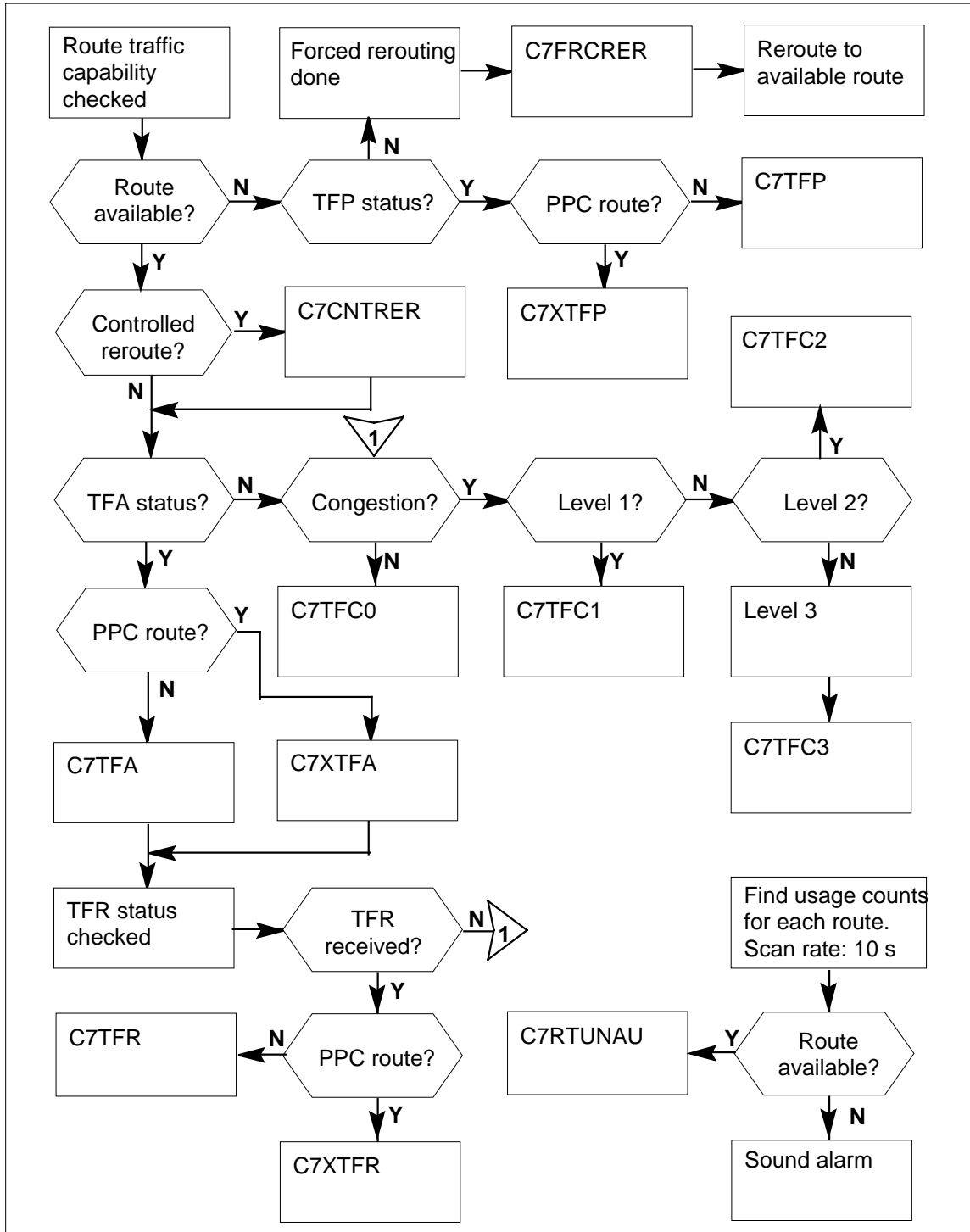

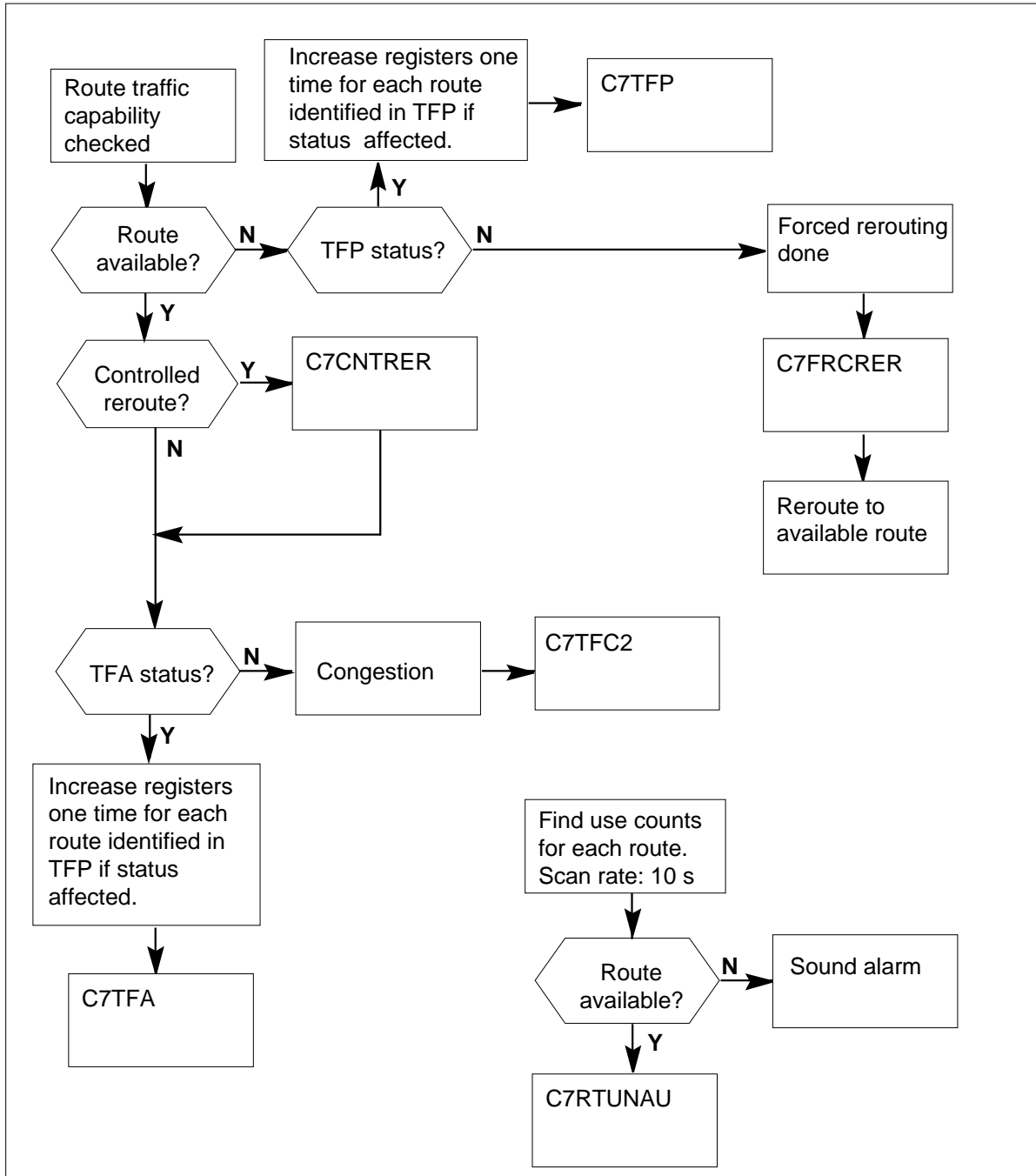
OM group C7ROUTE (continued)**OM group C7ROUTE registers for Japan public network****Register C7CNTNER**

CCS7 controlled rerouting (C7CNTNER)

OM group C7ROUTE (continued)

Register *C7CNTRER* counts controlled rerouting procedures for a route. Controlled rerouting indicates that a route from which the system diverts traffic has traffic restored. The system diverted messages to this route. This register is counted in central control (CC).

Register C7CNTRER release history

Register *C7CNTRER* was introduced in BCS20.

BCS35

Register also counts for JPN.

BCS21

The register was activated.

Associated registers

There are no associated registers.

Associated logs

There are no associated logs.

Extension registers

There are no extension registers.

Register C7FRCRER

CCS7 forced rerouting (*C7FRCRER*)

Register *C7FRCRER* counts forced rerouting procedures undertaken for a route.

When a route to a destination fails, the system reroutes messages to alternate available routes. A transfer prohibited status (TFP) message arrives to indicate a failed route. The route is not available to transmit messages. An alarm occurs at the routeset level.

This register is counted in central control (CC).

Register C7FRCRER release history

Register *C7FRCRER* was introduced in BCS20.

BCS35

Register also counts for JPN.

BCS21

Register activated.

OM group C7ROUTE (continued)

Associated registers

There are no associated registers.

Associated logs

There are no associated logs.

Extension registers

There are no extension registers.

Register C7RTUNAU

CCS7 route unavailable (C7RTUNAU)

Register C7RTUNAU is a usage register. The system scans the route every 10 s, and C7RTUNAU records if the route transmits messages. If one of the routes of the routeset is not able to deliver messages, an alarm occurs.

Register increases in central control (CC).

Register C7RTUNAU release history

Register C7RTUNAU was introduced in BCS20.

BCS35

Register also counts for JPN.

BCS33

When office parameter OMINERLANGS is Y, use the OMSHOW command on the ACTIVE class to convert the use count. Use the OMSHOW command to convert the use count from CCS to deci-erlangs before the usage counts appear. The value held in the active registers does not change and remains in CCS.

BCS30

Software change introduced to provide use counts in CCS or deci-erlangs.

Associated registers

There are no associated registers.

Associated logs

There are no associated logs.

Extension registers

There are no extension registers.

OM group C7ROUTE (continued)

Register C7TFA

CCS7 transfer allowed (C7TFA)

Register C7TFA counts transfer allowed (TFA) status messages received for a route.

A TFA message indicates that the CCS7 network has a good grade of service for the specified route. One destination point code (DPC) in the routing label specifies this route.

The register is counted in central control (CC).

Register C7TFA release history

Register C7TFA was introduced in BCS20 and zeroed.

BCS35

For the Japan public network, registers C7TFA and C7TFP increase one time for each affected route. A destination point code (DPC) identifies the affected route. The DPC uses TFA or the TFP messages to identify the route.

A single DPC can identify more than one route. The TFA and the TFP messages can have up to 13 DPCs that identify one or more routes. For example, a TFA message can contain five DPCs. The first three DPCs identify one route each. The last three DPCs identify 10 routes each. For this message the register C7TFA increases 33 times if the status of each route changes.

Registers C7XTFA, C7XTFP, and C7XTFR were introduced to include counts for TFA, TFR, and TFP messages. A CCS7 node received these messages. These message were from remote signaling points entered as partial-point-code (PPC) routes. These registers increase if enhanced cluster routing (ECR) is active.

BCS21

The register was activated.

Associated registers

There are no associated registers.

Associated logs

The system generates CCS166 when a CCS7 route receives the TFA signal from the network.

Extension registers

There are no extension registers.

OM group C7ROUTE (continued)

Register C7TFC0

CCS7 transfer controlled level 0 (zero) (C7TFC0)

Register C7TFC0 counts transfer controlled level 0 (zero) congestion status messages received for a specified route. This message indicates that congestion on the route is not present.

This register is counted in central control (CC).

Register C7TFC0 release history

Register C7TFC0 was introduced in BCS20.

BCS21

Register activated.

Associated registers

Register C7TFC1 counts transfer controlled level 1 congestion status messages received for a route.

Register C7TFC2 counts transfer controlled level 2 congestion status messages received for a route.

Register C7TFC3 counts transfer controlled level 3 congestion status messages received for a route.

Associated logs

The system generates CCS172 when the system receives a transfer controlled signal. An increase or a decrease in the congestion level of a routeset can cause the system to generate CCS172.

Extension registers

There are no extension registers.

Register C7TFC1

CCS7 transfer controlled level 1 (C7TFC1)

Register C7TFC1 counts transfer controlled level 1 congestion status messages received for a specified route. This message indicates that route congestion reaches the threshold set for level 1. User parts stop the transmission of messages of priority 0 (zero). A routeset major alarm occurs.

This register is counted in central control (CC).

OM group C7ROUTE (continued)

Register C7TFC1 release history

Register C7TFC1 was introduced in BCS20.

BCS21

The register was activated.

Associated registers

Register C7TFC0 counts transfer controlled level 0 (zero) congestion status messages received for a route.

Register C7TFC2 counts transfer controlled level 2 congestion status messages received for a route.

Register C7TFC3 counts transfer controlled level 3 congestion status messages received for a route.

Associated logs

The system generates CCS172 when the system receives a transfer controlled signal. An increase or a decrease in the congestion level of a routeset can cause the system to generate CCS172.

Extension registers

There are no extension registers

Register C7TFC2

CCS7 transfer controlled level 2 (C7TFC2)

Register C7TFC2 counts transfer controlled level 2 congestion status messages received for a specified route. This message indicates that route congestion reaches the threshold set for level 2. User parts stop the transmission of messages of priority 0 (zero) and 1. A routeset major alarm occurs.

This register is counted in central control (CC).

Register C7TFC2 release history

Register C7TFC2 was introduced in BCS20.

BCS35

The register also counts for JPN.

BCS21

Register activated.

OM group C7ROUTE (continued)

Associated registers

Register C7TFC0 counts transfer controlled level 0 (zero) congestion status messages received for a route.

Register C7TFC1 counts transfer controlled level 1 congestion messages received for this route.

Register C7TFC3 counts transfer controlled level 3 congestion status messages received for this route.

Associated logs

The system generates CCS172 when the system receives a transfer controlled signal. An increase or a decrease in the congestion level of a routeset can cause the system to generate CCS172.

Extension registers

There are no extension registers.

Register C7TFC3

CCS7 transfer controlled level 3 (C7TFC3)

Register C7TFC3 counts transfer controlled level 3 congestion status messages received for a specified route. This message indicates that route congestion reached the threshold set for level 3. User parts stop the transmission of messages of priority 0 (zero), 1, and 2. A routeset major alarm occurs.

This register is counted in central control (CC).

Register C7TFC3 release history

Register C7TFC3 was introduced in BCS20.

BCS21

The register was activated.

Associated registers

The C7TFC0 counts transfer controlled level 0 (zero) congestion status messages received for a route.

Register C7TFC1 counts transfer controlled level 1 congestion status messages received for a route.

Register C7TFC2 counts transfer controlled level 2 congestion status messages received for a route.

OM group C7ROUTE (continued)

Associated logs

The system generates CCS173 when the transmission buffer of a CCS7 link congests.

Extension registers

There are no extension registers.

Register C7TFP

CCS7 transfer prohibited (C7TFP)

Register C7TFP counts transfer prohibited (TFP) status messages received for a route. This message indicates that the CCS7 network cannot deliver messages on this route to the destination point code (DPC). The routing label specifies the DPC. A routeset alarm occurs.

This register is counted in central control (CC).

Register C7TFP release history

Register C7TFP was introduced in BCS20.

BCS35

For the Japan public network, registers C7TFA and C7TFP increase once for each affected route that a destination point code (DPC) identifies. The DPC identifies the route in TFA or the TFP messages.

A DPC can identify more than one route. The TFA and the TFP messages can have up to 13 DPCs. For example, a TFP message can contain five DPCs. The first three DPCs identify one route each and the last three identify 10 routes each. For this message the register C7TFA increases 33 times if the status of each route has changes.

Registers C7XTFA, C7XTFP, and C7XTFR were introduced to include counts for TFA, TFR and TFP messages that a CCS7 node receives. The CCS7 receives messages from remote signaling points entered as partial-point-code (PPC) routes. These registers increase if enhanced cluster routing (ECR) is active.

BCS21

The register was activated.

Associated registers

There are no associated registers.

OM group C7ROUTE (continued)

Associated logs

The system generates CCS168 when a CCS7 route receives the transfer prohibited signal from the network.

Extension registers

There are no extension registers.

Register C7TFR

CCS7 transfer restricted (C7TFR)

Register C7TFR counts transfer restricted status messages received for a route. This message indicates that the CCS7 network offers degraded service for the route. The system delivers message, but not as quickly as normal. A major alarm occurs.

This register is counted in central control (CC).

Register C7TFR release history

Register C7TFR was introduced in BCS20.

BCS35

Register C7XTFA, C7XTFP and C7XTFR were introduced to include counts for TFA, TFR and TFP messages received by a CCS7 node. The CCS7 node receives those messages from remote signaling points entered as partial-point-code (PPC) routes. These registers increase if enhanced cluster routing (ECR) is active.

BCS21

The register was activated.

Associated registers

There are no associated registers.

Associated logs

The system generates CCS167 when a CCS7 route receives the transfer restricted signal from the network.

Extension registers

There are no extension registers.

Register C7XTFA

CCS7 exception-list transfer allowed (C7XTFA)

OM group C7ROUTE (continued)

Register C7XTFA counts the number of transfer-allowed (TFA) messages received for partial-point-code routes. This register increases if enhanced cluster routing (ECR) is active.

A TFA message indicates that the CCS7 network has a satisfactory grade of service for this specified route. One destination point code (DPC) in the routing label specifies this route.

The register is counted in central control (CC).

Register C7XTFA release history

Register C7XTFA was introduced in BCS35.

Associated registers

There are no associated registers.

Associated logs

The system generates CCS180 when a CCS7 partial-point-code route receives the TFA signal from the network.

Extension registers

There are no extension registers.

Register C7XTFP

CCS7 exception-list transfer prohibited (C7XTFP)

Register C7XTFP counts the number of transfer-prohibited (TFP) messages received for partial-point-code routes. This message indicates that the CCS7 network cannot deliver messages on this route to the destination point code (DPC). The routing label specifies the DPC. A routeset alarm occurs.

This register is counted in central control (CC).

Register C7XTFP release history

Register C7XTFP was introduced in BCS35.

Associated registers

There are no associated registers.

Associated logs

The system generates CCS182 when a CCS7 partial-point-code route receives the transfer prohibited signal from the network.

OM group C7ROUTE (end)

Extension registers

There are no extension registers.

Register C7XTFR

CCS7 exception-list transfer restricted (C7XTFR)

Register C7XTFR counts the number of transfer-restricted messages received for partial-point-code routes. This message indicates that the CCS7 network offers degraded service for the route. The system delivers messages but not as quickly as normal. A major alarm occurs.

This register is counted in central control (CC).

Register C7XTFR release history

Register C7XTFR was introduced in BCS35.

Associated registers

There are no associated registers.

Associated logs

The system generates CCS181 when a CCS7 partial-point-code route receives the transfer restricted signal from the network.

Extension registers

There are no extension registers.

OM group C7ROUTE2

OM description

CCS7 route (C7ROUTE2)

The OM group C7ROUTE2 describes the performance and use of Common Channel Signaling 7 (CCS7) routes. Refer to OM group C7ROUTE for details of message routing.

The OM group C7ROUTE2 is responsible for reporting on half of the common channel signaling routes. These routes associate with the last 1023 routesets in table C7RTESET at a service switching point (SSP) office.

This OM group only applies to offices that require entries for more than 1023 routesets.

Release history

CSP04

OM group C7ROUTE2 introduced and activated.

Registers

The MAP terminal displays the following OM group C7ROUTE2 registers:

C72RTUNU	C72TFA	C72TFR	C72TFP
C72TFC0	C72TFC1	C72TFC2	C72TFC3
C72CNTRE	C72FRCRE	C72XTFA	C72XTFR
C72XTFP			

Group structure

The OM group C7ROUTE2 provides one tuple for each route in each routeset, a maximum of 1023 for each office

Key field:

This field contains the routeset name

Info field:

This field contains the route number within the routesetThe number of tuples: 6138

Associated OM groups

The OM group C7ROUTE associates with the C7ROUTE2 OM group.

OM group C7ROUTE2 (continued)

The OM group C7ROUTE2 collects the same information as the C7ROUTE OM group. The OM group C7ROUTE2 reports on the last 1023 routesets in the SSP office.

Associated functional groups

The functional group CCS7 associates with the OM group C7ROUTE2.

Associated functionality codes

The following table shows the functionality codes for OM group C7ROUTE2.

Functionality	Code
Remote Line Module	NTX023AB
CCS& MTP/SCCP	NTX041AB
International Switching Center-Basic	NTX300AA

OM group C7ROUTE2 (continued)

OM group C7ROUTE2 registers

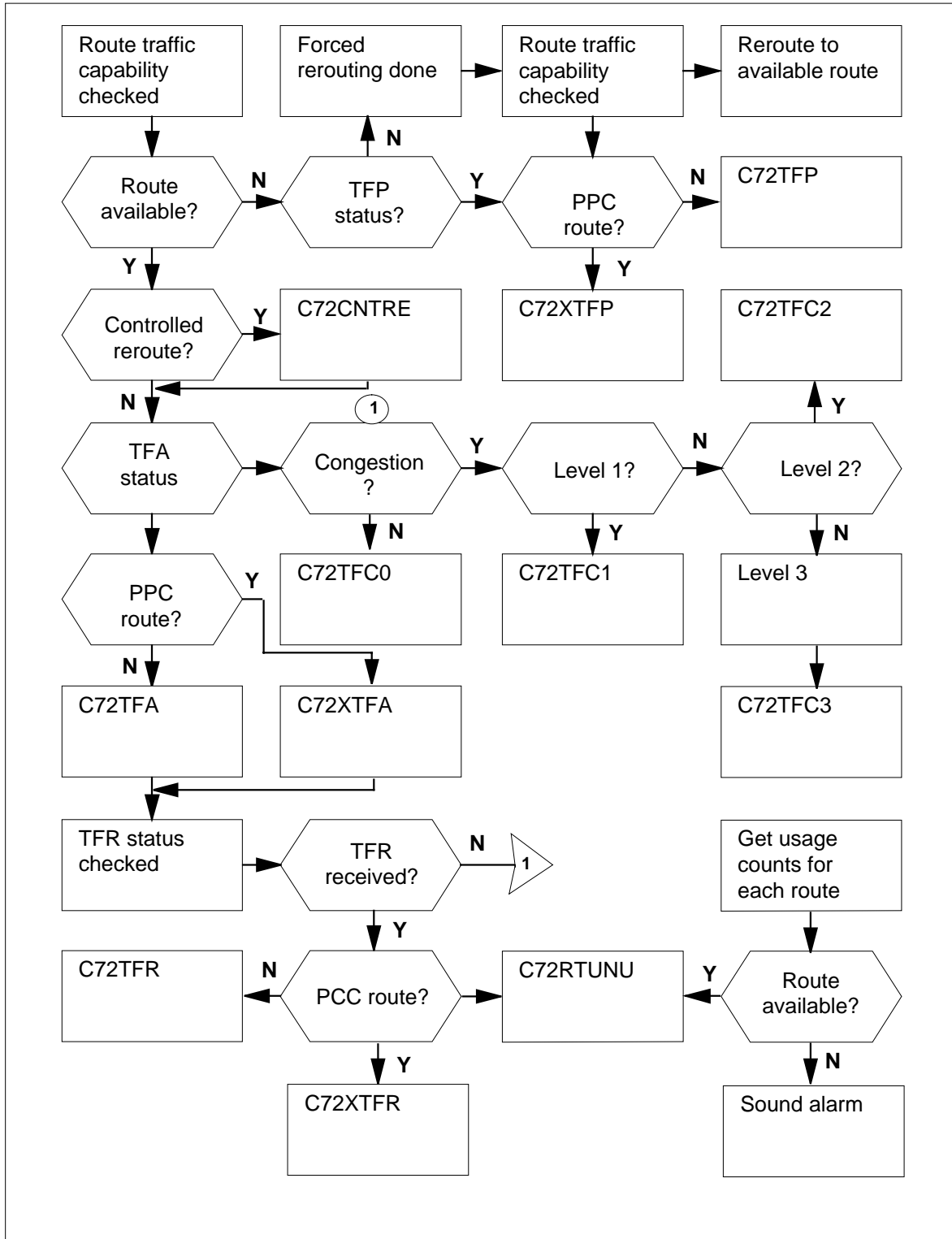

OM group C7ROUTE2 (continued)

Register C72CNTRE

Register CCS7 transfer controlled rerouting (C72CNTRE).

The C72CNTRE counts controlled rerouting procedures for a route. Controlled rerouting indicates that a route had traffic diverted. With the route restored, messages return to this route.

This register is counted in computing module (CM).

Register C72CNTRE release history

Register C72CNTRE was introduced and activated in CSP04.

Associated registers

Register C7CINTRER

Associated logs

There are no associated logs.

Register C72FRCRE

CCS7 transfer controlled rerouting (C72FRCRE)

Register C72FRCRE counts the forced rerouted procedures performed for a route.

When a route to a destination fails, the system routes messages to other available routes. The indication of a failed route arrives as a transfer prohibited status (TFP) message. The route is not available to transmit messages. Either a major or a critical alarm occurs at the routeset level.

This register is counted in the computing module CM.

Register C72FRCRE release history

Register C72FRCRE was introduced and activated in CSP04.

Associated registers

Register C7FRRCRER

Associated logs

There are no associated logs.

Register C72RTUNU

Register CCS7 route not available.

OM group C7ROUTE2 (continued)

Register C72RTUNU is a use register. The system scans the route every 10 s, and the register records if the route can transmit messages at this time. Either a major or a critical alarm occurs if the routeset can not deliver messages.

This register increases in the CM.

Register C72CTUNU release history

Register C72CTUNU was introduced and activated in CSP04.

Associated registers

Register C7RTUNAU

Associated logs

There are no associated logs.

Register C72TFA

CCS7 transfer allowed (C72TFA)

Register C72TFA counts the transfer allowed (TFA) messages that are received for a route. A TFA message indicates that the CCS7 network has a complete grade of service for this route.

The register is counted in the CM.

Register C72TFA release history

Register C72TFA was introduced and activated in CSP04.

Associated registers

Register C7TFA

Associated logs

The system generates CCS166 when a CCS7 route receives the TFA signal from the network.

Register C72TFC0

CCS7 transfer controlled level 0 (C72TFC0)

Register C72TFC0 counts transfer controlled level 0 (zero) congestion Status Messages that are received for a route. This message indicates that there is no congestion on the route

The register is counted in the CM.

OM group C7ROUTE2 (continued)

Register C72TFC0 release history

Register C72TFC0 was introduced to CSP04.

Associated registers

Register C7TFC0 counts transfer controlled level 0 congestion Status Messages that are received for a route.

Associated logs

The system generates CCS 172 when a transfer controlled signal is received. The system generates the log as a result either of an increase or drop in the congestion level of a routeset.

Register C72TFC1

CCS7 transfer controlled level 1

Register C72TFC1 counts transfer controlled level 1 congestion Status Messages that the system received for a route. This message indicates that that route congestion reached a threshold level set for level 1. User parts stop sending messages of priority 0. A routeset major alarm occurs.

The register is counted in the CM.

Register C72TFC1 release history

C72TFC1 was introduced to and activated in CSP04.

Associated registers

Register C7TFC1

Associated logs

The system generates CCS 172 when the system receives a transfer-controlled signal. The system generates a log as a result either of an increase or drop in the congestion level of a routeset.

Register C72TFC2

CCS7 transfer controlled level 2 (C72TFC2)

Register C72TFC2 counts transfer controlled level 2 congestion Status Messages received for a route. This message indicates that route congestion reached the threshold level set for level 2. User parts stop sending messages of priority 0 and 1. A routeset major alarm occurs.

The register is counted in the CM.

OM group C7ROUTE2 (continued)

Register C72TFC2 release history

Register C72TFC2 was introduced to and activated in CSP04.

Associated registers

Register C7TFC2

Associated logs

The system generates CCS 172 when the system receives a transfer-controlled signal. The system generates the log a result either of an increase or drop in the congestion level of a routeset.

Register C72TFC3

Register CCS7 transfer controlled level 3

Register C72TFC3 counts transfer controlled level 3 congestion Status Messages messages received for a route. This message indicates that route congestion reached the threshold level set for level 3. User parts stop sending messages of priority 0 and 1 and 2. A routeset major alarm occurs.

The register is counted in the CM.

Register C72TFC3 release history

C72TFC3 was introduced and activated in CSP04.

Associated registers

Register C7TFC3

Associated logs

The system generates CCS 173 when there is a congested transmission buffer for a CCS7 link

Register C72TFP

CCS7 transfer prohibited (C72TFP)

Register C72TFP counts the transfer prohibited (TFP) status messages that the system receives for a route. This message indicates that the CCS7 network cannot deliver messages on the route. Either a major or a critical alarm occurs at the routeset.

The register is counted in the CM.

Register C72TFP release history

C72TFP2 was introduced to and activated in CSP04.

OM group C7ROUTE2 (continued)

Associated registers

Register C7TFP

Associated logs

The system generates CCS168 when a CCS7 route receives the transfer prohibited signal from the network.

Register C72TFR

CCS7 transfer restricted (C72TFR)

Register C72TFR counts the transfer restricted (TFR) Status Messages received for a route. This message indicates a degraded CCS7 network service for the route. The system delivers the messages at a pace slower than the normal rate. A routeset major alarm occurs at the routeset level.

The register is counted in the CM.

Register C72TFR release history

Register C72TFR was introduced and activated in CSP04.

Associated registers

Register C7TFR

Associated logs

The system generates CCS167 when a CCS7 route receives the transfer restricted signal from the network.

Register C72XTFA

CCS7 transfer allowed for a partial-point-code (PPC) route (C72XTFA)

Register C72XTFA counts the number of transfer allowed (TFA) messages received for a PPC route.

A TFA message indicates that the CCS7 network has a complete grade of service for this PPC route.

The register is counted in the CM.

Register C72XTFA release history

Register C72XTFA was introduced to and activated in CSP04.

Associated registers

Register C7XTFA

OM group C7ROUTE2 (end)

Associated logs

The system generates CCS180 when a CCS7 PPC receives the TFA signal from the network.

Register C72XTFP

CCS7 transfer prohibited for PPC route.

C72XTFP counts the number of TFP Status Messages received for a route. This message indicates that the CCS7 network cannot deliver messages on this route. Either a major or a critical alarm occurs for the routeset.

The register is counted in the CM.

Register C72XTFP release history

Register C72XTFP was introduced and activated in CSP04.

Associated registers

Register C7XTFP

Associated logs

The system generates CCS182 when a CCS7 PPC route receives the transfer prohibited signal from the network.

Register C72XTFR

CCS7 exception-list transfer restricted

Register C72XTFR counts the number of TFR Status Messages the system receives for a PPC route. This message indicates a degraded CCS7 network service for the route. The system delivers the messages at a pace that is slower than the normal rate. A major alarm occurs at the routeset level.

The register is counted in the CM.

Register C72CNTRE release history

Register C72CNTRE was introduced and activated in CSP04 .

Associated registers

Register C7XTFR

Associated logs

The system generates CCS181 when a CCS7 PPC route receives the transfer restricted signal from the network.

OM group C7ROUTER

OM description

This OM group captures the Common Channel Signaling 7 (CCS7) routes information. The router receives messages from CCS7 peripheral modules and performs the routing function on these messages.

C7ROUTER tracks

- the number of messages and bytes the system receives for routing
- the high-water marks of messages for each second the router receives
- the number of messages the system discards because of congestion
- the number of times and amount of time when the router is congested or out of service

These measurements determine if the router operates in capacity and indicate the work load during the OM period.

Release history

CSP04

Registers C7INTOVL, C7MTSHW, C7RTCNG and C7RTCNGU were activated. Register C7RTOOSU changed to reflect the time the router was either Sysb or ManB.

BCS36

The OM group C7ROUTER was introduced to BCS36.

Registers

The OM group C7ROUTER registers appear on the MAP terminal as follows:

C7RTMSR	C7RTMSR2	C7RTBTR	C7RTBTR2
C7INTOVL	C7INTOV2	C7BUFOFL	C7ILLPHW
C7MTSHW	C7STHW	C7TOTHW	C7RTCNG
C7RTCNGU	C7RTOOS	C7RTOOSU	

Group structure

OM group C7ROUTER provides one tuple for each router, a maximum of 32 tuples for each office.

Key field:

This field contains the router number.

OM group C7ROUTER (continued)

Info field:

This field has two parts: the peripheral module (PM) type and the PM number of the router. Only LIU7 is supported as a PM type in BCS36.

Associated OM groups

There are no associated OM groups.

Associated functional groups

There are no associated functional groups.

Associated functionality codes

The associated functionality codes for the OM group C7ROUTER appear in the following table:

Functionality	Code
LIU7 Routing	NTXS77AA

OM group C7ROUTER registers: local router message processing

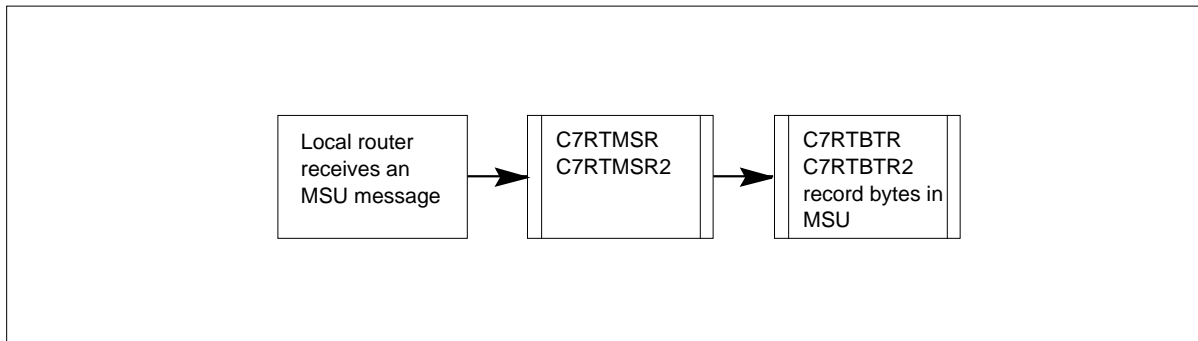

OM group C7ROUTER (continued)

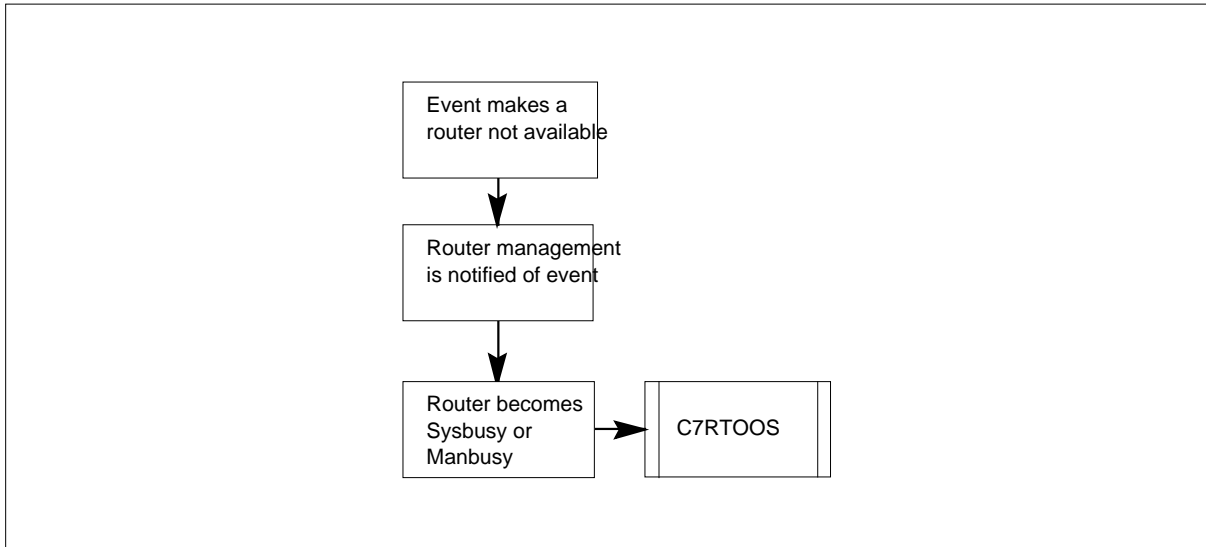
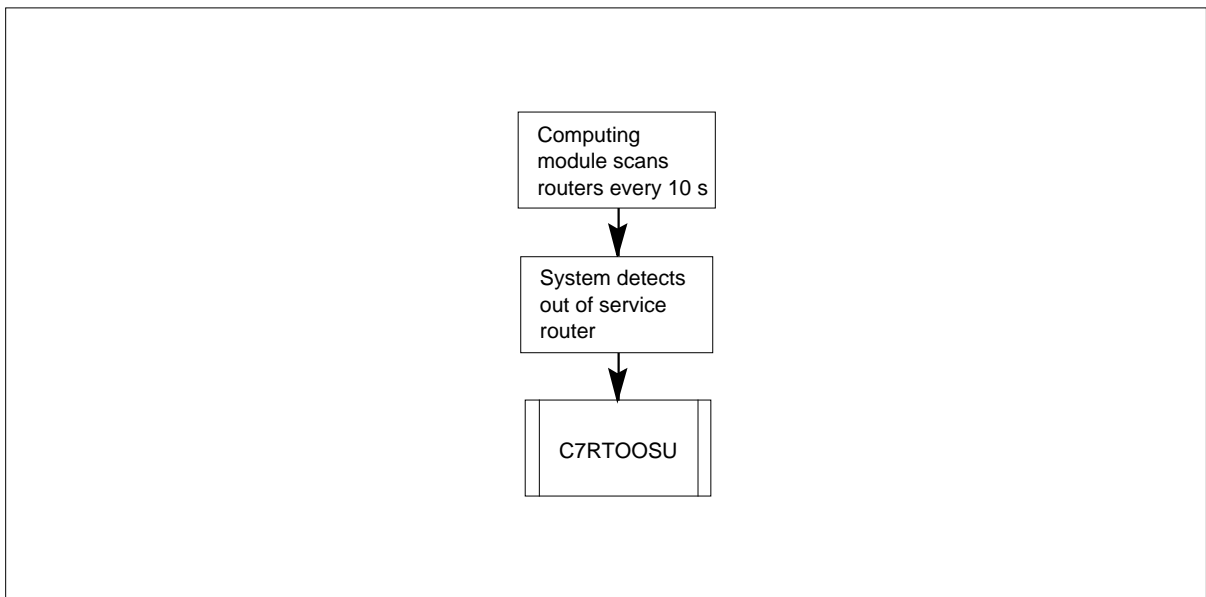
OM group C7ROUTER registers: router management on CM**OM group C7ROUTER registers: usage registers****Register C7BUFOFL**

CCS7 buffer overflow (C7BUFOFL)

Register C7BUFOFL set to zero.

OM group C7ROUTER (continued)

Register C7BUFOFL release history

Register C7BUFOFL was introduced in BCS36.

Associated registers

There are no associated registers.

Associated logs

There are no associated logs.

Register C7ILLPHW

Inter-link-to-link protocol (ILLP) high-water mark for messages received (C7ILLPHW)

Register C7ILLPHW is set to zero.

Register C7ILLPHW release history

Register C7ILLPHW was introduced in BCS36.

Associated registers

There are no associated registers.

Associated logs

There are no associated logs.

Register C7INTOVL

Number of message service units the system discards because of interrupt overload (C7INTOVL)

Register C7INTOVL release history

CSP04

Register C7INTOVL activated.

BCS36

Register C7INTOVL was introduced and set to zero.

Associated registers

C7INTOV2

Associated logs

There are no associated logs.

OM group C7ROUTER (continued)

Register C7MTSHW

Message transport system (MTS) high-water mark for messages received (C7MTSHW)

Register C7MTSHW release history**CSP04**

Register C7MTSHW activated.

BCS36

Register C7MTSHW was introduced to BCS36.

Associated registers

There are no associated registers.

Associated logs

There are no associated logs.

Register C7RTBRT

CCS7 router bytes received for routing (C7RTBTR)

Register C7RTBTR increases for each message signal unit (MSU) the CCS7 router receives when the system starts the routing function. This register records the number of bytes the system receives.

Register C7RTBTR release history

Register C7RTBTR was introduced to BCS36.

Associated registers

Register C7RTMSR measures messages to route. The register records the number of MSUs. The register does not record the number of bytes.

Associated logs

There are no associated logs.

Extension registers

C7RTBTR2

Register C7RTCNG

The system increases the register when router reports first onset of congestion from level 0 to level 1.

OM group C7ROUTER (continued)

Register C7RTCNG release history

CSP04

Register C7RTCNG activated.

BCS36

Register C7RTCNG was introduced and set to zero.

Associated registers

C7RTCNGU

Associated logs

The system generates CCS189 log when the external router congestion level changes.

Register C7RTCNGU

CCS7 router congested recorded in seconds (C7RTCNGU)

Register C7RTCNGU release history

CSP04

Register C7RTCNGU activated.

BCS36

Register C7RTCNGU was introduced and set to zero.

Associated registers

C7RTCNG

Associated logs

There are no associated logs.

Register C7RTMSR

CCS7 router message signal units (MSU) received for routing (normal)
(C7RTMSR)

Register C7RTMSR increases for each MSU the CCS7 router receives when the routing function is initiated.

Register C7RTMSR release history

Register C7RTMSR was introduced in BCS36.

Associated registers

Register C7RTBTR measures messages to route. The register records the number of bytes. The register does not record the number of units.

OM group C7ROUTER (continued)

Associated logs

There are no associated logs.

Extension registers

C7RTMSR2

Register C7STHW

Signaling terminal high-water mark for messages received (C7STHW)

Register C7STHW is set to zero.

Register C7STHW release history

Register C7STHW was introduced in BCS36.

Associated registers

There are no associated registers.

Associated logs

There are no associated logs.

Register C7TOTHW

Total high-water mark for messages received (C7TOTHW)

Register C7TOTHW is set to zero.

Register C7TOTHW release history

Register C7TOTHW was introduced in BCS36.

Associated registers

There are no associated registers.

Associated logs

There are no associated logs.

Register C7RTOOS

C7 router out of service (C7RTOOS)

Register C7RTOOS counts the number of times the C7 router is out of service. Register C7RTOOS increases when the router becomes system busy (Sysbusy) or Manual busy (Manbusy) from an In-Service state (InSv or ISTb).

Note: The register does not increase if the state toggles between Sysbusy and Manbusy.

OM group C7ROUTER (end)

Register C7RTOOS release history

Register C7RTOOS was introduced in BCS36.

Associated registers

Register C7RTOOSU records the time in seconds that the router is not available. The router is not available because the router is in a Sysbusy, Manbusy, or Offline state.

Associated logs

There are no associated logs.

Register C7RTOOSU

Length of time the C7 router was out of service (C7RTOOSU)

Register C7RTOOSU records the time in seconds that the C7 router is out of service. The router is out of service because the router is in a Sysbusy, Manbusy, or Offline state. Register C7RTOOSU records the time based on a 10 s scan. Register C7RTOOSU time when the router is Offline.

Register C7RTOOSU release history

CSP04

Register C7RTOOSU changed to record the time the router is SySB or ManB.

BCS36

Register C7RTOOSU was introduced in BCS36.

Associated registers

Register C7RTOOS counts the times the router is out of service. The router is out of service because the router entered a Sysbusy or Manbusy state from InSv or ISTb state.

Associated logs

There are no associated logs.

OM group C7RTESET

OM description

CCS7 routeset (C7RTESET)

Register C7RTESET reports on the performance and use of a Common Channel Signaling 7 (CCS7) routeset.

Signaling messages provide the address and link selector information that determines message routing. The messages describe a routeset. The routeset consists of:

- the signaling paths (routes)the signaling paths (routes)
- linksets
- links in the linkset for routing a message to a destination

The system routeset management determines if the routing for transmitting messages is acceptable. If the route is acceptable, the system selects a working link from the linkset. If the route is not acceptable, the system examines other routes until the system finds or cannot find a working link. The system also receives remote congestion information over a route, and the system informs user parts of the congestion level.

Release history

The OM group C7RTESET was introduced in BCS20.

BCS33

Use the OMSHOW command on the ACTIVE class to convert registers C7RSUNAU and C7RSCNGU from CCS to deci-erlangs before they display.

BCS30

Software change provides use counts in CCS or deci-erlangs. This option is set in table OFCOPT.

BCS21

Register C7RSCNGU activated

Registers

The OM group C7RTESET registers appear on the MAP terminal as follows:

C7RSUNAU	C7RSFAIL	C7RSMANB	C7RSCNGU
C7RTERR			

OM group C7RTESET (continued)

Group structure

The OM group C7RTESET provides one tuple for each routeset.

Key field:

The C7_ROUTESET_NUMBER, is in the range 0 to 254. The C7_ROUTESET_NUMBER is used as an index into table C7RTESET or used to display by route name.

Info field:

There is no info field.

Associated OM groups

The OMs C7LINK1 and C7LINK2 track link availability and link use.

The OM C7LKSET tracks linksets.

The OM C7ROUTE tracks component routes.

Associated operating groups

There are no associated operating groups.

Associated functionality codes

The functionality codes associated with OM group C7RTESET, appear in the following table.

Functionality	Code
CCS7 MTP/SCCP	NTX041AB
Internal Switching Center - Basic	NTX300AA

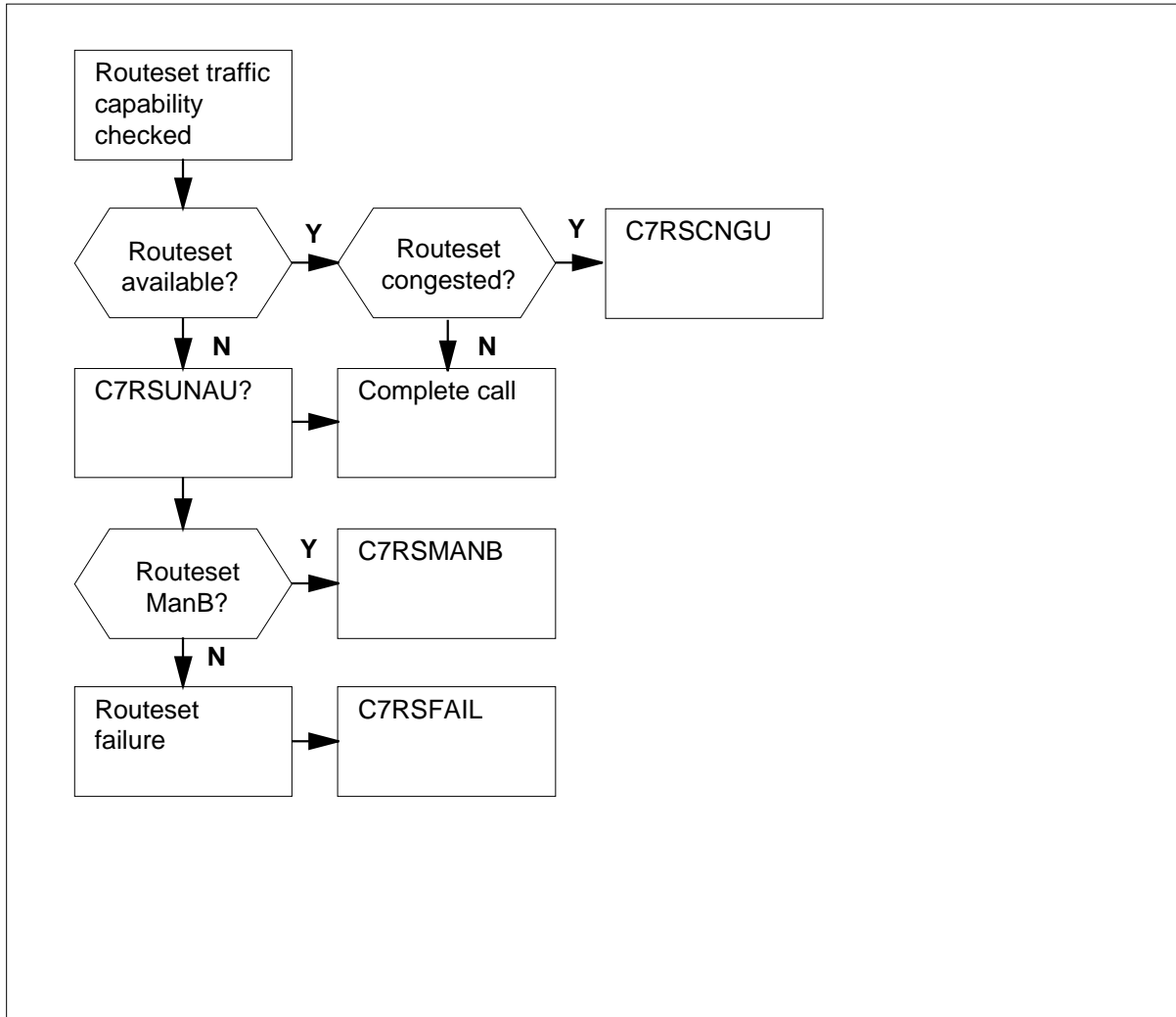
OM group C7RTESET (continued)**OM group C7RTESET registers****Register C7RSCNGU**

CCS7 routeset congestion (C7RSCNGU)

Register C7RSCNGU is a use register. The scan rate is every 10 s. This register records routeset congestion.

When the routeset is congested, a major alarm occurs on the CCS7 destination. The system only delivers higher priority messages.

Register C7RSCNGU release history

Register C7RSCNGU was introduced in BCS20.

OM group C7RTESET (continued)

BCS33

The OMSHOW command on the ACTIVE class converts the use count from CCS to deci-erlangs before the use count displays. The OMSHOW command converts the use count when office parameter OMINERLANGS is Y in table OFCOPT. The OMSHOW command does not alter the value in the active registers. The value of the active registers remains in CCS.

BCS30

Software change provides use counts in CCS or deci-erlangs.

BCS21

Register C7RSCNGU activated

Associated registers

There are no associated registers.

Associated logs

The system generates CCS172 when a routeset congestion is present.

Register C7RSFAIL

CCS7 routeset failure (C7RSFAIL)

Register C7RSFAIL counts routeset failures where the routeset does not transmit messages.

When the routeset does not transmit messages, the common channel signaling destination is not available. A critical alarm occurs.

This register increases in the computing module (CM).

Register C7RSFAIL release history

Register C7RSFAIL was introduced in BCS20.

Associated registers

Register C7RSUNAU records if a routeset is not available.

Associated logs

The system generates CCS154 when a routeset is not available to deliver traffic to the correct destination. All traffic to the destination stops.

Register C7RSMANB

CCS7 routeset manual busy (C7RSMANB)

OM group C7RTESET (continued)

Register C7RSMANB increases when operating company personnel manually busy the routeset. The common channel signaling destination is not available. A critical alarm occurs.

This register increases in the CM.

Register C7RSMANB release history

Register C7RSMANB was introduced in BCS20.

Associated registers

There are no associated registers.

Associated logs

The system generates CCS152 when a routeset is manually busy.

Register C7RSUNAU

CCS7 routeset not available (C7RSUNAU)

Register C7RSUNAU is a use register. The scan rate is every 10 s. This register records if the routeset transmits messages. This register does not increase when the routeset is offline.

If the routeset does not transmit messages, one of the common channel signaling destinations is not available. A critical alarm occurs.

This register increases in the CM.

Register C7RSUNAU release history

Register C7RSUNAU was introduced in BCS20.

BCS33

The OMSHOW command on the ACTIVE class converts the use count from CCS to deci-erlangs before the use count displays. The OMSHOW command converts the use count when office parameter OMINERLANGS is Y in table OFCOPT. The OMSHOW command does not alter the value in the active registers. The value of the active registers remains in CCS.

BCS30

Software change provides use counts in CCS or deci-erlangs.

Associated registers

There are no associated registers.

OM group C7RTESET (end)

Associated logs

This register records after a CC restart, until CCS155 appears. This register increases in the period between CCS154 and CCS155.

The system generates CCS154 when a routeset is not available to deliver traffic to the destination. All traffic to the destination stops.

The system generates CCS155 when a routeset can deliver traffic to its destination after a stop. All traffic to the destination is restored.

Register C7RTERR

CCS7 routing error (C7RTERR)

Register C7RTERR counts messages that the system cannot route through the routeset. The system cannot route through the routeset because of a routing error.

Register C7RTERR release history

Register C7RTERR was introduced in BCS20.

Associated registers

There are no associated registers.

Associated logs

There are no associated logs.

OM group C7SCCP

OM description

CCS7 signaling connection control part (C7SCCP)

The OM group C7SCCP registers report the performance and use of the CCS7 signaling connection control part (SCCP). The registers count the number of

- messages the SCCP routing control (SCRC) handles
- messages formatted to UDT user data
- formatted messages that arrive at the SCRC
- global title translations (GTT), messages that correctly reach their destinations
- messages that reach the destination
- messages that fail to reach the destination
- discarded messages with the priority level lower than the internal SCCP congestion level

The SCCP transfers signaling units and provides flexible GTT for different applications.

Some signaling units use logical signaling connection. These units are connection-oriented. Some units do not use logical signaling connection. These units are connectionless. Operational measurements count different aspects of connectionless services. Connectionless services appear in two categories:

- Class 0 data units arrive at different times. These units do not require sequencing
- Class 1 data units arrive in sequence

The SCRC routes the following:

- messages that the message transfer part (MTP) delivers to local subsystems. The MTP uses SCCP connectionless control (SCLC) to deliver these messages.
- messages that originate at local subsystems. Local subsystems are SCCP users. SCLC delivers these messages to other local subsystems.
- messages that originate at local subsystems. The SCRC routes these messages to the network that uses the MTP.

The called party address (CDPA) includes the destination of the message that the application supplies. The CDPA consists of any group of a destination

OM group C7SCCP (continued)

point code (DPC), subsystem number (SSN), or global title (GT). A GT is an application address. An example of a GT is an 800 number of the TCAP/E800 service. SCRC translates a GT to an address form that the SCCP and MTP can use to route the message. This form contains a DPC and an SSN, or a DPC and a GT.

SCCP connectionless control formats the user data to a unitdata (UDT) or extended unitdata (XUDT) message. This message is of the correct class with the requested options. The SCLC delivers these messages to SCRC. The SCRC routes the messages. The SCLC decodes and distributes messages for local subsystems to the correct subsystem. When a routing failure occurs, SCRC starts the return procedure for unitdata messages with the set return option parameter. The routing failure procedure of the SCLC formats the message and the routing failure reason. The routing failure procedure formats the routing failure reason to a UDTS or XUDTS message. The routing failure procedure delivers the message to SCRC. The SCRC routes the message to the originator.

Release history

The OM group C7SCCP was introduced in BCS21.

TL14

Registers C7RTFALL and C7RTFNWC updated for ITU SCCP Congestion Control feature.

TL06

The registers C7RTFALL, C7MSGHDL, C7MSGHD2, C7MSGGT, C7MSGGT2, C7CLS0TX, C7CLS0T2, C7CLS0RX, C7CLS0R2, C7CLS1TX, C7CLS1T2, C7CLS1RX, C7CLS1R2, C7SYNERR, C7RTBKSS, C7LOCSS AND C7LOCSS2 increase for SCCP Segmentation and Reassembly.

BCS31

Registers C7RTFALL, C7RTFNNTN, C7RTFNNTA, C7RTFNWF, C7UDTTX, C7UDTTX2, C7UDTRX, C7UDTRX2, C7UDTSTX, C7UDTSRX, C7MSGHDL, C7MSGHD2, C7CLS0TX, C7CLS0T2, C7CLS0RX, C7CLS0R2, C7CLS1TX, C7CLS1T2, C7CLS1RX, C7CLS1R2, and C7SYNERR increase for international gateway SCCP.

BCS25

Registers C7LOCSS, C7LOCSS2, and C7RTBKSS were introduced.

OM group C7SCCP (continued)**BCS22**

Registers C7UDTTX2, C7UDTRX2, C7MSGHD2, C7MSGGT2, C7CLS0T2, C7CLS0R2, C7CLS1T2, and C7CLS1R2 activated. Register C7SYNERR was introduced.

BCS21

Registers C7CLS1R2, C7CLS1T2, C7CLS0R2, C7CLS0T2, C7MSGGT2, C7MSGHD2, C7UDTRX2, and C7UDTT2 were set to zero.

Registers

The OM group C7SCCP registers appear in the MAP terminal as follows:

C7RTFALL	C7RTFNNTN	C7RTFNNTA	C7RTFNWF
C7RTFNWC	C7RTFSSF	C7RTFSSC	C7RTFUEQ
C7UDTTX	C7UDTTX2	C7UDTRX	C7UDTRX2
C7UDTSTX	C7UDTSRX	C7MSGHDL	C7MSGHD2
C7MSGGT	C7MSGGT2	C7CLS0TX	C7CLS0T2
C7CLS0RX	C7CLS0R2	C7CLS1TX	C7CLS1T2
C7CLS1RX	C7CLS1R2	C7SYNERR	C7RTBKSS
C7LOCSS	C7LOCSS2		

Group structure

The OM group C7SCCP provides one tuple for each office.

Key field:

there are no key fields

Info field:

there are no info fields

Associated OM groups

The following OM groups associate with OM group C7SCCP:

- C7LINK1 and C7LINK2 track link availability and link use.
- C7RTESET tracks routeset availability.
- C7ROUTE tracks the component routes.
- C7LKSET tracks the performance and use of a CCS7 linkset.

Associated functional groups

The functional group CCS7 associates with OM group C7SCCP.

OM group C7SCCP (continued)

Associated functionality codes

The associated functionality codes that associate with OM group C7SCCP appear in the following table.

Functionality	Code
CCS7-MTP Associated and Non-Associated Signaling	NTX041AA
CCS7-MTP/SCCP	NTX041AB
SS7 Transaction Service Support	NTX550AA

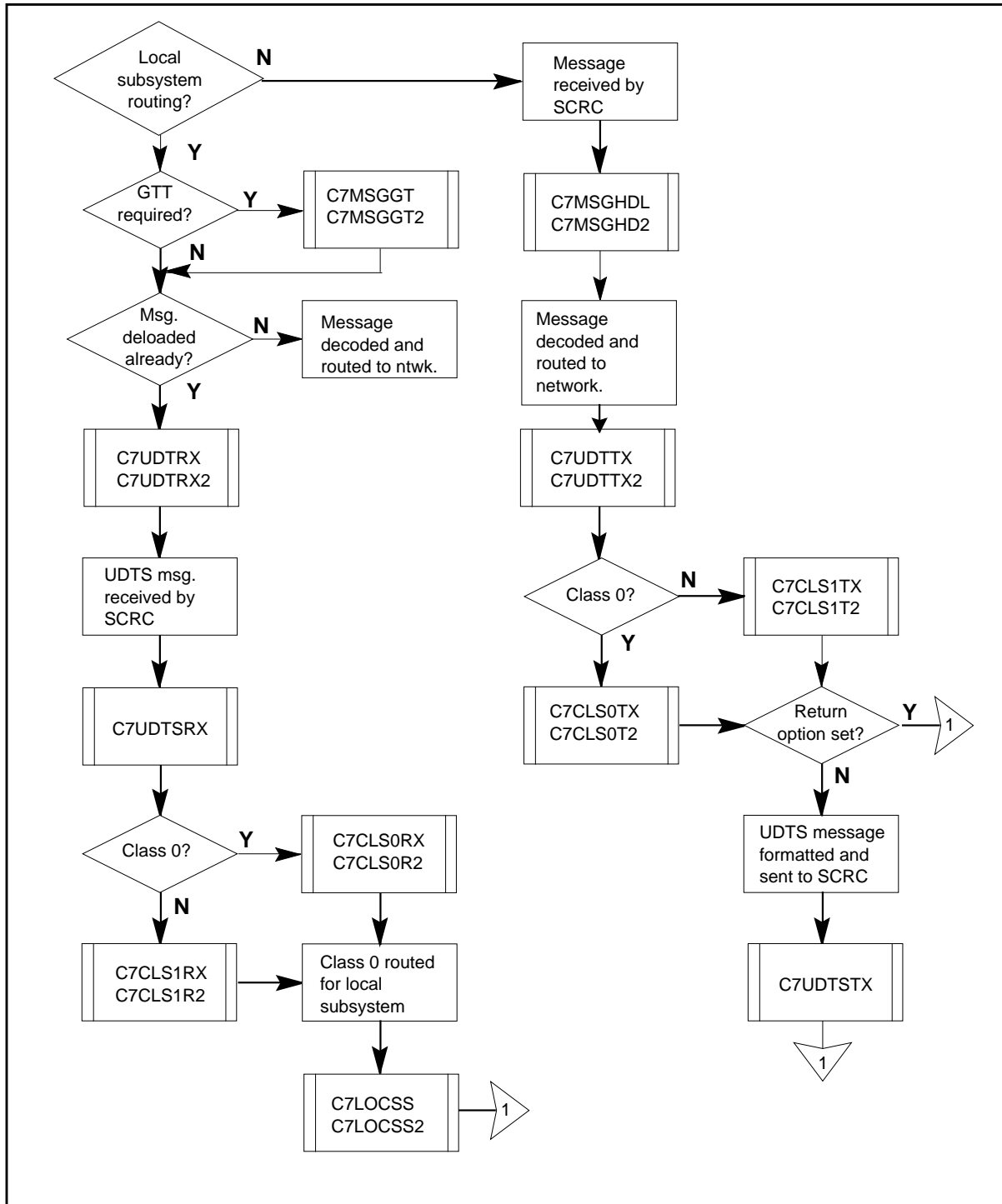
OM group C7SCCP (continued)**OM group C7SCCP registers**

OM group C7SCCP (continued)

OM group C7SCCP registers (continued)

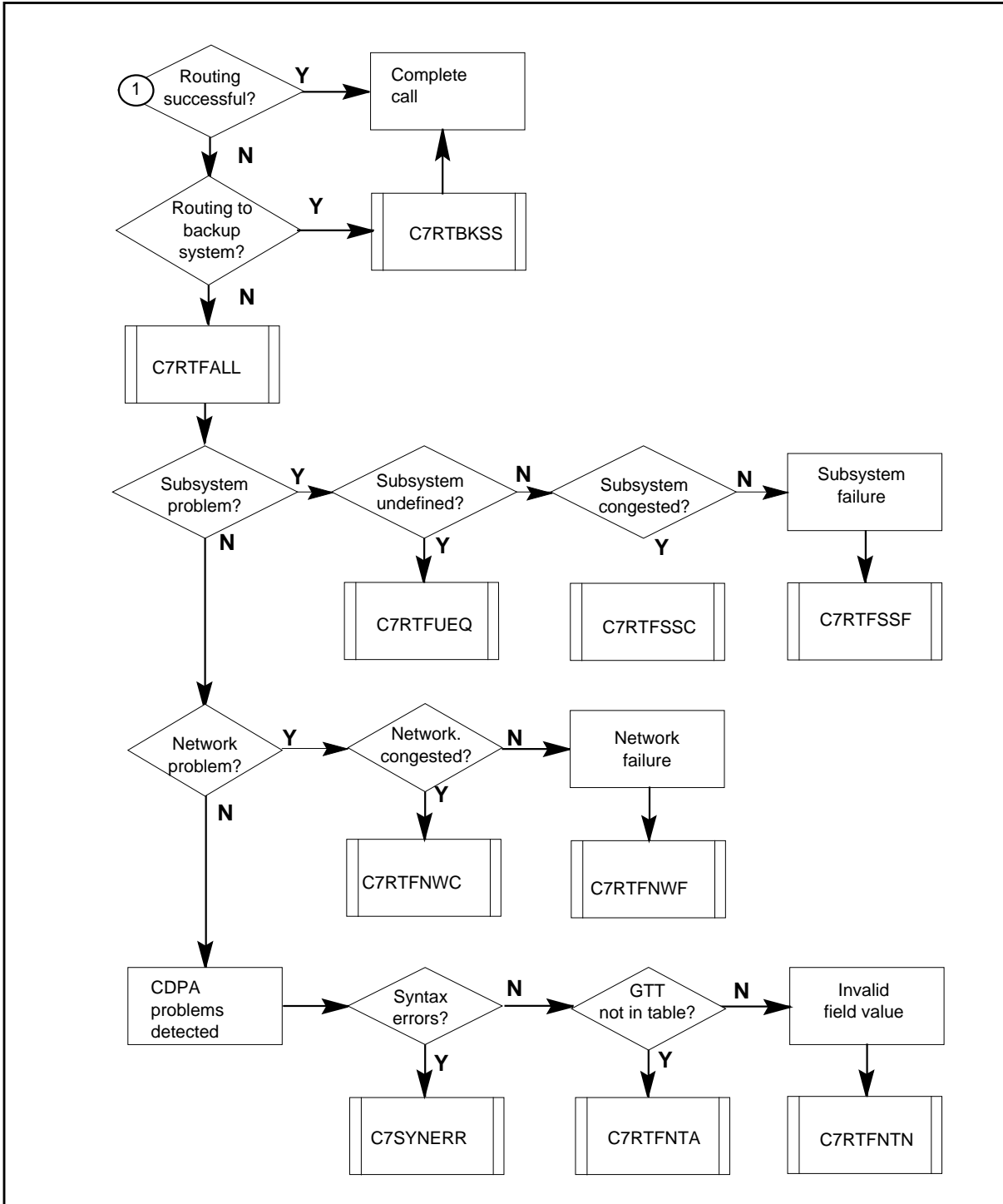

OM group C7SCCP (continued)

Register C7CLS1RX

CCS7 connectionless class 1 received (C7CLS1RX)

The register C7CLS1RX counts unitdata (UDT) and the extended unitdata (XUDT) connectionless class 1 SCCP messages. The SCCP routing control (SCRC) receives these messages from the CCS7 network. The CCS7 network sends messages through the message transfer part (MTP). Connectionless class 1 messages are specified data units that have in-sequence delivery.

Register C7CLS1RX release history

Register C7CLS1RX was introduced in BCS21.

TL06

The SCCP Segmentation and Reassembly increases register C7CLS1RX.

BCS31

Register C7CLS1RX increases for international gateway SCCP.

BCS22

Register C7CLS1R2 activated.

Associated registers

There are no associated registers.

Associated logs

There are no associated logs.

Extension registers

Register C7CLS1R2 is an extension register

Register C7CLS1TX

CCS7 connectionless class 1 transmitted (C7CLS1TX)

The register C7CLS1TX counts unitdata (UDT) and the extended unitdata (XUDT) connectionless class 1 SCCP messages. The system routes these messages to the CCS7 network through the message transfer part (MTP). Connectionless class 1 messages are specified data units that have in-sequence delivery.

Register C7CLS1TX release history

Register C7CLS1TX was introduced BCS21.

TL06

The SCCP Segmentation and Reassembly increases register C7CLS1RX.

OM group C7SCCP (continued)

BCS31

The register C7CLS1TX increases for international gateway SCCP.

BCS22

The register C7CLS1T2 activated.

Associated registers

There are no associated registers.

Associated logs

There are no associated logs.

Extension registers

Register C7CLS1T2 is an associated extension register.

Register C7CLS0RX

CCS7 connectionless class 0 received (C7CLS0RX)

The register C7CLS0RX counts unitdata (UDT) and extended unitdata (XUDT) connectionless class 0 SCCP messages. The SCCP routing control (SCRC) receives these messages from the CCS7 network. The CCS7 network sends the messages through the message transfer part (MTP). Connectionless class 0 messages are specified data units that do not have sequencing.

Register C7CLS0RX release history

Register C7CLS0RX was introduced in BCS21.

TL06

The SCCP Segmentation and Reassembly increases register C7CLS0RX.

BCS31

The register C7CLS0RX increases for international gateway SCCP.

BCS22

The register C7CLS0R2 activated.

Associated registers

There are no associated registers.

Associated logs

There are no associated logs.

Extension registers

The register C7CLS0R2 is an extension register.

OM group C7SCCP (continued)

Register C7CLS0TX

CCS7 connectionless class 0 transmitted (C7CLS0TX)

The register C7CLS0TX counts unitdata (UDT) and extended unitdata (XUDT) connectionless class 0 SCCP messages. The system routes these messages to the CCS7 network through the message transfer part (MTP). Connectionless class 0 messages are specified data units that do not have sequencing.

Register C7CLS0TX release history

Register C7CLS0TX was introduced in BCS21.

TL06

The SCCP Segmentation and Reassembly increases register C7CLS0TX.

BCS31

Register C7CLS0TX increases for international gateway SCCP.

BCS22

Register C7CLS0T2 activated.

Associated registers

There are no associated registers.

Associated logs

There are no associated logs.

Extension registers

The register C7CLS0T2 is an extension register.

Register C7LOCSS

CCS7 local subsystem (C7LOCSS)

Register C7LOCSS counts UDT/UDTS and XUDT/XUDTS messages for a local subsystem. The SCCP routing control (SCRC) receives these messages from the CCS7 network through the message transfer part (MTP).

Register C7LOCSS release history

Register C7LOCSS was introduced in BCS25.

TL06

The SCCP Segmentation and Reassembly increases register C7LOCSS.

OM group C7SCCP (continued)

Associated registers

There are no associated registers.

Associated logs

There are no associated logs.

Extension registers

Register C7LOCSS2 is an extension register.

Register C7MSGGT

CCS7 message global title translations (C7MSGGT)

The register C7MSGGT counts UDT/UDTS and XUDT/XUDTS messages that SCCP routing control (SCRC) receives. These messages require global title translation (GTT).

Register C7MSGGT release history

Register C7MSGGT was introduced in BCS21.

TL06

The SCCP Segmentation and Reassembly increases register C7MSGTT.

BCS22

Register C7MSGGT2 activated.

Associated registers

There are no associated registers.

Associated logs

There are no associated logs.

Extension registers

The register C7MSGGT2 is an extension register.

Register C7MSGHDL

CCS7 messages handled (C7MSGHDL)

The register C7MSGHDL counts the following:

- UDT/UDTS and XUDT/XUDTS messages that SCCP routing control (SCRC) handles
- messages that local users send through SCCP connectionless control (SCLC)

OM group C7SCCP (continued)

- messages that the CCS7 network sends through the message transfer part (MTP)
- unitdata service (UDTS) messages
- extended unitdata service (XUDTS) messages

Register C7MSGHDL release history

Register C7MSGHDL was introduced in BCS21.

TL06

The SCCP Segmentation and Reassembly increases register C7MSGHDL.

BCS31

Register C7MSGHDL increases for international gateway SCCP.

BCS22

Register C7MSGHD2 activated.

Associated registers

Registers C7XUDTRX, C7XUDTSR, C7XUDTTX, C7XUDTST, C7UDTRX, C7UDTSRX, C7UDTTX and C7UDTSTX are associated registers.

Associated logs

There are no associated logs.

Extension registers

Register C7MSGHD2 is an extension register.

Register C7RTBKSS

The system routes CCS7 backup subsystem (C7RTBKSS)

The register C7RTBKSS counts UDT/UDTS and XUDT/XUDTS messages that the system routes to a backup subsystem. The system routes these messages to a backup system when the primary subsystem is not available.

Register C7RTBKSS release history

Register C7RTBKSS was introduced in BCS25.

TL06

The SCCP Segmentation and Reassembly increases register C7MSGHDL.

Associated registers

There are no associated registers.

OM group C7SCCP (continued)

Associated logs

There are no associated logs.

Register C7RTFALL

CCS7 route failure all (C7RTFALL)

The register C7RTFALL counts UDT/UDTS and XUDT/XUDTS messages that SCCP routing control (SCRC) receives that the system cannot route.

Messages that the system cannot route include the following:

- messages from the link through the message transfer part (MTP)
- messages from local subsystems routed through SCCP connectionless control (SCLC)
- messages with the incorrect encoding or with unknown fields
- messages with the internal priority code lower than the internal congestion level

Register C7RTFALL increases when the system attempts to send SCCP messages over a routeset that is offline. The system does not generate a log.

Register C7RTFALL release history

Register C7RTFALL was introduced in BCS21.

TL14

The ITU SCCP Congestion Control feature increases register C7RTFALL.

TL06

The SCCP Segmentation and Reassembly increases register C7RTFALL.

BCS31

Register C7RTFALL increases for international gateway SCCP.

Associated registers

Register C7XHCERR is an associated register.

Associated logs

The system generates CCS201 when the CCS7 network sends an SCCP message that is invalid. The system cannot decode this message.

The system generates CCS202 when the network sends an SCCP message that has a Called Party Address (CDPA) that is not valid. The system cannot route the message.

OM group C7SCCP (continued)

The system generates CCS203 when the network sends an SCCP message that has a Calling Party Address (CGPA) that is not valid. The system attempts to route the message.

The system generates CCS204 when the network sends an SCCP message that is for a local subsystem that is not known.

The system generates CCS205 when the network sends an SCCP message with the following characteristics.

- the message requires the local node to perform Global Title Translation (GTT)
- the global title contains a translation type for which the node does not have translation tables

The system generates CCS228 when the network sends a message that has the following characteristics:

- the message requires the local node to perform global title translation (GTT)
- the network address is not valid for a signaling connection control part (SCCP) at a service switching point (SSP). The system returns the message.

The system generates log CCS241 when the MTP in the CCS7 link interface unit (LIU7) or the high-speed link router (HSLR) does not route an incoming message. The system generates log CCS241 also when the message fails because the system did not route it in the LIU7 or HSLR, because of wrong message field information. The log indicates exact reason for the failure. If the number of routing failures received within a 1-min period exceeds the threshold value, generation of log CCS241 stops.

The system generates log CCS243 when the number of routing failures received within a 1-min period exceeds the threshold value. The log indicates the number of routing failures received every minute.

The system generates CCS246 when a global title (GT) translation occurs that is not correct for a unit data (UDT) message. This translation occurs before a gateway switch. The DMS-300 switch is a gateway switch.

The system generates log report CCS260 when the internal SCCP congestion level for a routeset in an ITU network changes.

The application can generate TCAP101 when the system receives an SCCP service message in response to a routing failure.

OM group C7SCCP (continued)

Register C7RTFNTA

CCS7 routing failure no translation for address (C7RTFMTA)

The register C7RTFNTA counts messages that SCCP routing control (SCRC) receives that the system cannot route. The system cannot route these messages because the field values No Translation for Such Address appear in the called party address (CDPA). These field values are not valid. This field value indicates that a translation in the global title translation table is not present. The translation is for the global title in the CDPA of the message.

Register C7RTFNTA release history

Register C7RTFNTA was introduced in BCS21.

BCS31

Register C7RTFNTA increases for international gateway SCCP.

Associated registers

There are no associated registers.

Associated logs

The application can generate TCAP101 when the system receives an SCCP service message in response to a routing failure. The diagnostic is No Translation for Such Address.

Register C7RTFNTN

CCS7 routing failure no translation of such nature (C7RTFNTN)

The register C7RTFNTN counts messages that SCCP routing control (SCRC) receives. The system cannot route these messages because the field values No Translation for an Address of Such Nature appear in the called party address (CDPA) of the message. These field values are not valid.

Register C7RTFNTN release history

Register C7RTFNTN was introduced in BCS21.

BCS31

Register C7RTFNTN increases for international gateway SCCP.

Associated registers

There are no associated registers.

OM group C7SCCP (continued)

Associated logs

The system generates CCS202 when the network receives an SCCP message that has an invalid Called Party Address (CDPA). The system generates CCS202 when the system cannot route the message.

The application can generate TCAP101 when the system receives an SCCP service message in response to a routing failure. The diagnostic is No Translation for an Address of Such Nature.

Register C7RTFNWC

CCS7 routing failure network congestion (C7RTFNWC)

The register C7RTFNWC counts messages that SCCP routing control (SCRC) receives. The system cannot route these messages because of network congestion.

Register C7RTFNWC release history**TL14**

The ITU SCCP Congestion Control feature increases register C7RTFNWC.

BCS21

Register C7RTFNWC was introduced.

Associated registers

There are no associated registers.

Associated logs

The application generates TCAP101 when the system receives an SCCP service message in response to a routing failure. The application generates TCAP101 when the system cannot route the message because of network congestion.

The system generates log report CCS260 when the internal SCCP congestion level for a routeset in an ITU network changes.

Register C7RTFNWF

CCS7 routing failure network failure (C7RTFNWF)

Register C7RTFNWF counts messages that SCCP routing control (SCRC) receives. The system cannot route these messages because of network failure.

Register C7RTFNWF release history

Register C7RTFNWF was introduced in BCS21.

OM group C7SCCP (continued)

BCS31

Register C7RTFNWF increases for international gateway SCCP.

Associated registers

There are no associated registers.

Associated logs

The application can generate TCAP101 when the system receives an SCCP service message in response to a routing failure. The system cannot route the message because of network failure.

Register C7RTFSSC

CCS7 routing failure subsystem congestion (C7RTFSSC)

The register C7RTFSSC counts messages that SCCP routing control (SCRC) receives. The system cannot route these messages because of subsystem congestion.

Register C7RTFSSC release history

The register C7RTFSSC was introduced in BCS21.

Associated registers

There are no associated registers.

Associated logs

The application can generate TCAP101 when the system receives an SCCP service message in response to a routing failure. The system cannot route the message because of subsystem failure.

Register C7RTFSSF

CCS7 routing failure subsystem failure (C7RTFSSF)

The register C7RTFSSF counts messages that SCCP routing control (SCRC) receives. The system cannot route these messages because of subsystem failure.

Register C7RTFSSF release history

The register C7RTFSSF was introduced in BCS21.

Associated registers

There are no associated registers.

OM group C7SCCP (continued)

Associated logs

The application can generate TCAP101 when the system receives an SCCP service message in response to a routing failure. The system cannot route the message because of subsystem failure.

Register C7RTFUEQ

CCS7 routing failure user unequipped (C7RTFUEQ)

The register C7RTFUEQ counts messages that SCCP routing control (SCRC) receives. The system cannot route these messages because of a destination local subsystem that is not known.

Register C7RTFUEQ release history

Register C7RTFUEQ was introduced in BCS21.

Associated registers

There are no associated registers.

Associated logs

The system generates CCS204 when the network sends an SCCP message for a local subsystem that is not known.

The application generates TCAP101 when the system receives an SCCP service message in response to a routing failure. The system cannot route the message because the destination local subsystem is not known.

Register C7SYNERR

CCS7 syntax errors (C7SYNERR)

The register C7SYNERR counts UDT/UDTS and XUDT/XUDTS messages that SCCP routing control (SCRC) receives. The system cannot route these messages because syntax errors occur in the called party address (CDPA).

Register C7SYNERR release history

Register C7SYNERR was introduced in BCS22.

TL06

The SCCP Segmentation and Reassembly increases register C7SYNERR.

BCS31

Register C7SYNERR increases for international gateway SCCP.

OM group C7SCCP (continued)

Associated registers

There are no associated registers.

Associated logs

There are no associated logs.

Register C7UDTRX

CCS7 UDT received (C7UDTRX)

The register C7UDTRX counts unitdata (UDT) connectionless SCCP messages. The SCCP routing control (SCRC) receives these messages from the CCS7 network through the message transfer part (MTP).

Register C7UDTRX release history

Register C7UDTRX was introduced in BCS21.

BCS31

Register C7UDTRX increases for international gateway SCCP.

BCS22

Register C7UDTRX2 activated.

Associated registers

There are no associated registers.

Extension Register

Register C7UDTRX2 is an extension register.

Register C7UDTSRX

CCS7 UDTS received (C7UDTSRX)

The register C7UDTSRX counts unitdata service (UDTS) connectionless SCCP messages. The SCCP routing control (SCRC) receives these messages from the CCS7 network through the message transfer part (MTP). UDTS messages consist of a message that failed. This message has the return option and a routing failure reason.

Register C7UDTSRX release history

Register C7UDTSRX was introduced in BCS21.

BCS31

Register C7UDTSRX increases for international gateway SCCP.

OM group C7SCCP (continued)

Associated registers

There are no associated registers.

Associated logs

There are no associated logs.

Register C7UDTSTX

CCS7 UDTS sent

The register CCS7 UDTS sent (C7UDTSTX) counts unitdata service (UDTS) connectionless SCCP messages that the system routes to the network through the message transfer part (MTP). The UDTS message contains a message that failed. This message contains the return option and the routing failure reason.

Register C7UDTSTX release history

Register C7UDTSTX was introduced in BCS21.

BCS31

Register C7UDTSTX increases for international gateway SCCP.

Associated registers

There are no associated registers.

Associated logs

The application generates TCAP101 when the system receives an SCCP UDTS message.

Register C7UDTTX

CCS7 UDT transmitted (C7UDTTX)

The register C7UDTTX counts unitdata (UDT) connectionless SCCP messages. The system routes these messages to the network through the message transfer part (MTP).

Register C7UDTTX release history

Register C7UDTTX was introduced in BCS21.

BCS31

Register C7UDTTX increases for international gateway SCCP.

BCS22

Register C7UDTTX2 activated.

OM group C7SCCP (end)

Associated registers

There are no associated registers.

Associated logs

There are no associated logs.

Extension registers

Register C7UDTTX2 is an extension register.

OM group C7SCCPCO

OM description

C7 SCCP Connection Oriented (C7SCCPCO)

Register C7SCCPCO measures the volume of traffic and failures on the class 2 signaling connection control part (SCCP). Specifically, this OM group counts the total number of messages received and sent over the DMS-300 switch. The OM group produces separate counts for each type of message. The OM group also counts the number of times a connection is rejected or fails and has to be taken down.

The counts establish the overhead for the use of SCCP class 2 connections and point out design inefficiencies or indicate that you must adjust the timers. The overhead is normally 10-25 percent of the total DT1 messages. You must enter subsystems that support connection oriented SCCPs into table C7 LOCSSN.

Release history

The OM group C7SCCPCO was introduced in BCS35.

Registers

The OM group C7SCCPCO registers display on the MAP terminal as follows:

C7CLS2TX	C7CLS2T2	C7CLS2RX	C7CLS2R2
C7DT1TX	C7DT1T2	C7DT1RX	C7DT1R2
C7ITTX	C7ITRX	C7CRTX	C7CRT2
C7CRRX	C7CRR2	C7CCTX	C7CCT2
C7CCRX	C7CCR2	C7RLSDTX	C7RLSDT2
C7RLSDRX	C7RLSDR2	C7RLCTX	C7RLCT2
C7RLCRX	C7RLCR2	C7CREFRX	C7CREFTX
C7COFAIL	C7COMREJ		

Group structure

OM group C7SCCPCO

Key field:

There is no Key field.

Info field:

There is no Info field.

Associated OM groups

There are no associated OM groups.

OM group C7SCCPCO (continued)

Associated functional groups

There are no associated functional groups.

Associated functionality codes

The functionality codes associated with OM group C7SCCPCO are shown in the following table.

Functionality	Code
GSM Base	NTXM99AA

OM group C7SCCPCO registers

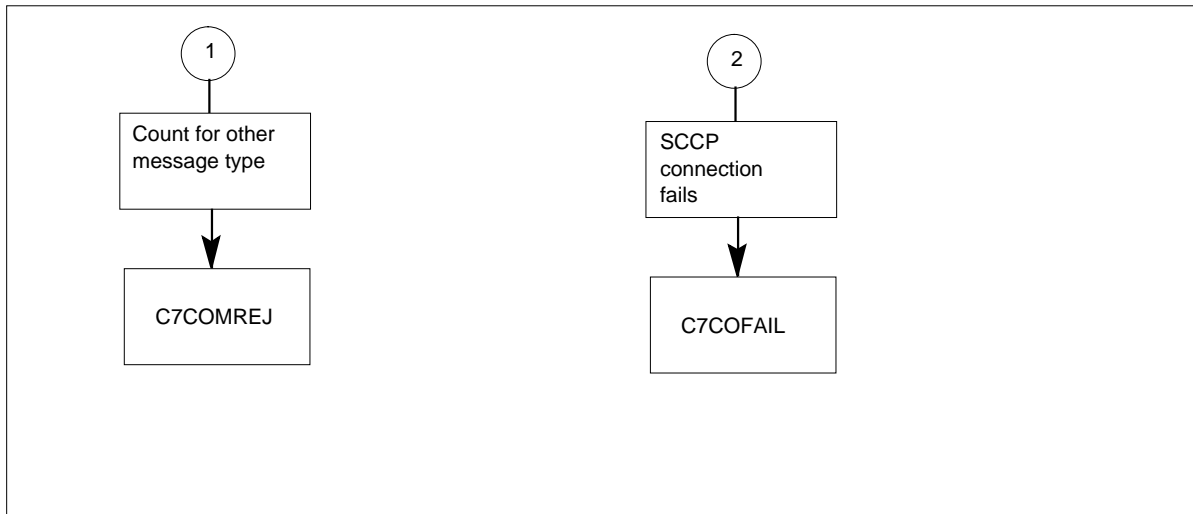

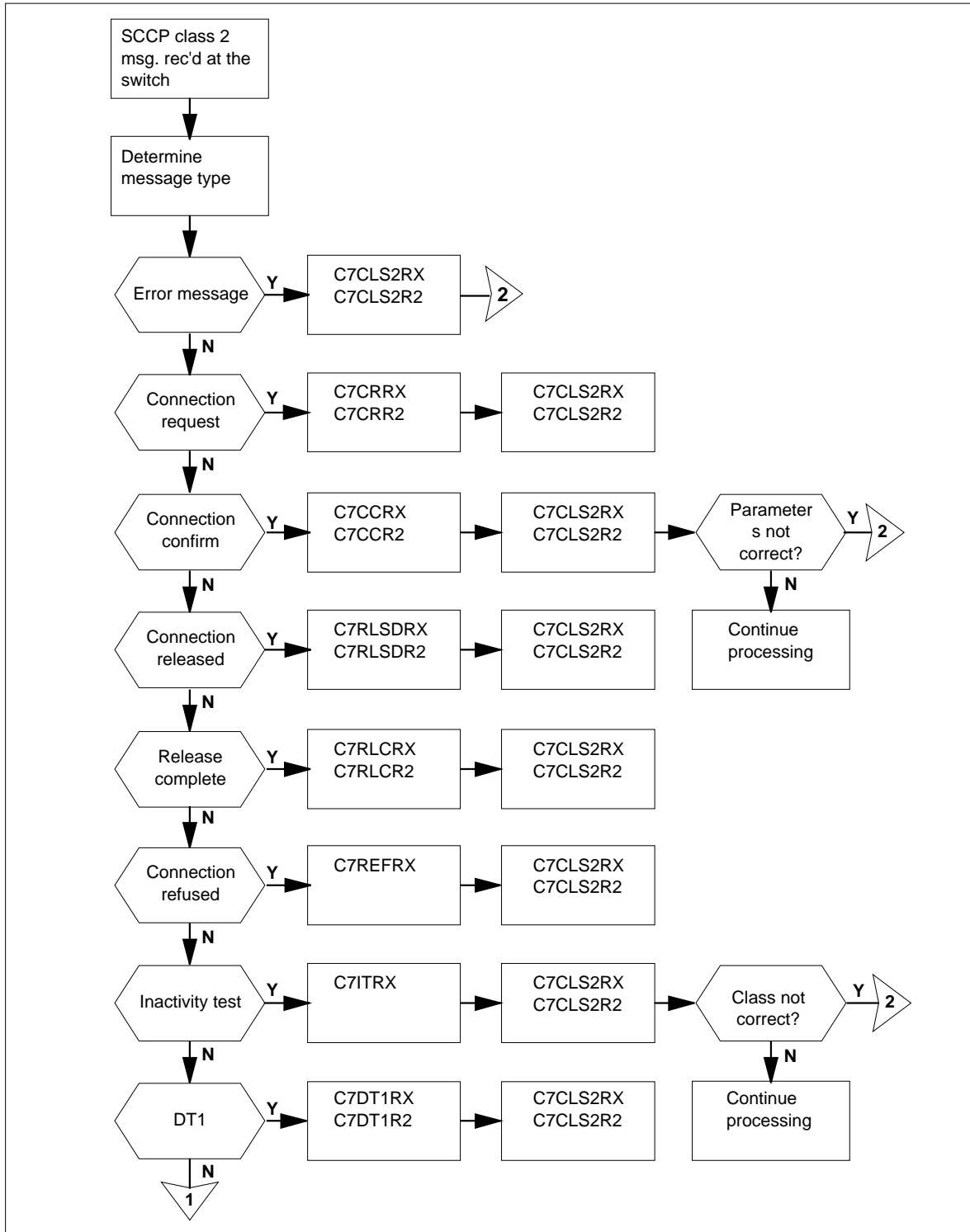
OM group C7SCCPCO (continued)**OM group C7SCCPCO registers: messages received**

OM group C7SCPCO (continued)

Register C7CCRX

SCCP CC messages received (C7CCRX)

Register C7CCRX counts the number of times the switch receives a connection confirm (CC) message from the application.

Register C7CCRX release history

Register C7CCRX was introduced in BCS35.

Associated registers

Register C7CLS2RX counts each time the switch receives a correct SCCP class 2 message from the application.

Associated logs

There are no associated logs.

Extension registers

C7CCR2

Register C7CCTX

SCCP CC messages transmitted (C7CCTX)

Register C7CCTX counts the number of times the switch sends a connection confirm (CC) message to the application.

Register C7CCTX release history

Register C7CCTX was introduced in BCS35.

Associated registers

Register C7CLS2TX counts each time the switch sends a correct SCCP class 2 message to the application.

Associated logs

There are no associated logs.

Extension registers

C7CCT2

Register C7CLS2RX

SCCP class 2 messages received (C7CCRX)

OM group C7SCCPCO (continued)

Registers *C7CCR*X counts the number of times the switch receives a correct class 2 message from the application. This register contains the total number of incoming correct class 2 messages transmitted across the CCS7 link.

Register C7CLS2RX release history

Register *C7CLS2RX* was introduced in BCS35.

Associated registers

There are no associated registers.

Associated logs

There are no associated logs.

Extension Register

C7CLS2R2

Register C7CLS2TX

SCCP class 2 messages transmitted

*C7CCR*X counts the number of times the switch sends a valid class 2 message to the application. The value in this register indicates the total number of valid outgoing messages transmitted across the CCS7 link.

Register C7CLS2TX release history

Registers *C7CLS2TX* was introduced in BCS35.

Associated registers

There are no associated registers.

Associated logs

There are no associated logs.

Extension Register

C7CLS2T2

Register C7COFAIL

SCCP connection failed

Register *C7CCR*X counts the number of connections that fail because of software errors such as the following: the IT message contains a correct class that is not correct, an ERR message is received, or a CC message contains data that is not correct. When this register increases, the system dismantles the connection.

OM group C7SCCPCO (continued)

Register C7COFAIL release history

C7COFAIL was introduced in BCS35.

Associated registers

There are no associated registers.

Associated logs

There are no associated logs.

Extension Register

There are no associated register.

Register C7COMREJ

SCCP connection messages rejected (C7COMREJ)

Register C7COMREJ counts the number of times the system discards a connection oriented message because it contains a message type that is not supported. The following message types are not supported: DT2 (Data Form 2), AK (Data acknowledge), ED (Expedited data), EA (Expedited data acknowledge), RSR (Reset request), and RSC (Reset confirm).

Register C7COMREJ release history

C7COMREJ was introduced in BCS35.

Associated registers

There are no associated registers.

Associated logs

There are no associated logs.

Extension Register

There are no extension registers.

Register C7CREFRX

SCCP CREF message received (C7CCREFX)

Register C7CCREFX counts the number of times the switch receives a connection refused (CREF) message from the application.

Register C7CREFRX release history

Register C7CREFRX was introduced in BCS35.

OM group C7SCCPCO (continued)

Associated registers

Register *C7CLS2RX* counts the number of times the switch receives a correct class message is received by the switch.

Associated logs

There are no associated logs.

Register C7CREFTX

SCCP CREF messages transmitted (*C7CCREFTX*)

Register *C7CCR*X counts the number of times the switch sends a connection refused (CREF) message to the application. This event occurs, for example, when the local subsystem is not in service or if the maximum number of connections (2048) are already established.

Register C7CREFTX release history

Register *C7CREFTX* was introduced in BCS35.

Associated registers

Register *C7CLS2TX* counts each time the switch sends a correct class 2 message across the CCS7 link.

Associated logs

There are no associated logs.

Register C7CRRX

SCCP CR messages received (*C7CRRX*)

Register *C7CRRX* counts the number of times the switch receives a connection request (CR) message from the application.

Register C7CRRX release history

Register *C7CRRX* was introduced in BCS35.

Associated registers

Register *C7CLS2RX* counts the number of times the switch receives a correct class 2 message.

Associated logs

There are no associated logs.

Extension Register

C7CRR2

OM group C7SCPCO (continued)

Register C7CRTX

SCCP CR messages transmitted (C7CRTX)

Register C7CRTX counts the number of times the switch sends a connection request (CR) message to the application.

Register C7CRTX release history

Register C7CRTX was introduced in BCS35.

Associated registers

Register C7CLS2TX counts each time the switch sends a correct class 2 message across the CCS7 link.

Associated logs

There are no associated logs

Extension Register

C7CRT2

Register C7DT1RX

SCCP DT1 messages received (C7DT1RX)

Register C7DT1RX counts the number of times the switch receives a Data Form 1 (DT1) message from the application.

Register C7DT1RX release history

Register C7DT1RX was introduced in BCS35.

Associated registers

Register C7CLS2RX counts the number of times the switch receives a correct class 2 message.

Associated logs

There are no associated logs.

Extension Register

C7DT1R2

Register C7DT1TX

SCCP DT1 messages transmitted

Register C7DT1TX counts the number of times the switch sends a Data Form 1 (DT) message to the application.

OM group C7SCCPCO (continued)

Register C7DT1TX release history

Register C7DT1TX was introduced in BCS35.

Associated registers

Register C7CLS2TX counts each time the switch sends a correct class 2 message across the CCS7 link.

Associated logs

There are no associated logs.

Extension Register

C7DT1T2

Register C7ITRX

SCCP IT messages received (C7ITRX)

Register C7ITRX counts the number of times the switch receives an inactivity test (IT) message from the application. This event occurs when a timeout of the inactivity send timer occurs at the far end.

Register C7ITRX release history

Register C7ITRX was introduced in BCS35.

Associated registers

There are no associated registers.

Associated logs

There are no associated logs.

Register C7ITTX

SCCP IT messages transmitted (C7ITTX)

C7ITTX counts the number of times the switch sends an inactivity test (IT) message to the application. This event occurs when a timeout of the inactivity send timer occurs at the local end. This timer tracks the time between consecutive messages sent on an active connection in table SCCPTMR contains the value of this timer.

The value in this register is used to determine if the timeouts are set at too short an interval and are not efficient because of the large number of IT messages sent.

OM group C7SCPCO (continued)

Register C7ITTX release history

Register C7ITTX was introduced in BCS35.

Associated registers

There are no associated registers.

Associated logs

There are no associated logs.

Extension Register

There are no associated registers.

Register C7RLCRX

SCCP release complete messages received (C7CCRX)

Register C7CCRX counts the number of times the switch receives a release complete (RLC) message from the application. The far end sends this message in response to a RLSD message from the local end.

Register C7RLCRX release history

Register C7RLCRX was introduced in BCS35.

Associated registers

Register C7CLS2RX counts the number of times the switch receives a correct class 2 message.

Associated logs

There are no associated logs.

Extension Register

C7RLCR2

Register C7RLCTX

SCCP RLC messages transmitted

Register C7RLCTX counts the number of times the switch sends a release complete (RLC) message to the application. The switch sends this message in response to an RLSD message if a valid connection was present or not.

Register C7RLCTX release history

Register C7RLCTX was introduced in BCS35.

OM group C7SCCPCO (continued)

Associated registers

Register C7CLS2TX counts each time the switch sends a correct class 2 message across the CCS7 link.

Associated logs

There are no associated logs.

Extension Register

C7RLCT2

Register C7RLSDRX

SCCP RLSD messages received (C7RLSDRX)

C7RLSDRX counts the number of times the switch receives a released (RLSD) message from the application. This message indicates that the far end wants to release the established connection.

Register C7RLSDRX release history

Register C7RLSDRX was introduced in BCS35.

Associated registers

Register C7CLS2RX counts the number of times the switch receives a class 2 message.

Associated logs

There are no associated logs.

Extension Register

C7RLSDR2

Register C7RLSDTX

SCCP RLSD messages transmitted

Register C7RLSDTX counts the number of times the switch sends a released (RLSD) message to the application.

Register C7RLSDTX release history

Register C7RLSDTX was introduced in BCS35.

Associated registers

Register C7CLS2TX counts each time the switch sends a correct class 2 message across the CCS7 link.

OM group C7SCCPCO (end)

Associated logs

There are no associated logs.

Extension Register

C7RLSDT2

OM group C7SCCPX

OM description

The OM group C7SCCPX registers provide information on the performance and use of extended unitdata and extended unitdata service (XUDT/XUDTS) messages. These registers count the number of messages that are formatted into extended unitdata messages and extended unitdata service messages. The registers also count messages that encounter reassembly errors and messages that encounter hop counter problems.

Release history

The OM group C7SCCPX was introduced in TL06.

Registers

The following OM group C7SCCPX registers display on the MAP terminal as follows:

```
C7XUDTRX C7XUDTR2 C7XUDTSR C7XUDTTX
C7XUDTT2 C7XUDTST C7XTIMER C7XSGTOS
C7XRSERR C7XHCERR
```

Group structure

The OM group C7SCCPX provides one tuple for each office.

Key field:

There is no Key field.

Info field:

There is no Info field.

Associated OM groups

Associated operating groups

The following operating groups are for OM group C7SCCPX:

- Register C7SCCP tracks the performance and use of the CCS7 SCCP.
- Register C7LINK1 and C7LINK2 track link availability and link use.
- Register C7RTESET tracks routeset availability.
- Register C7ROUTE tracks the component routes.
- Register C7LKSET tracks the performance and use of a CCS7 LINKSET.

OM group C7SCCPX (continued)

Associated functionality codes

The associated functionality codes for OM group C7SCCPX appear in the following table.

Functionality	Code
CCS7-MTP associated and Non-associated Signaling	NTX041AA
CCS7-MTP/SCCP	NTX041AB
SS7 Transaction Service Support	NTX550AA

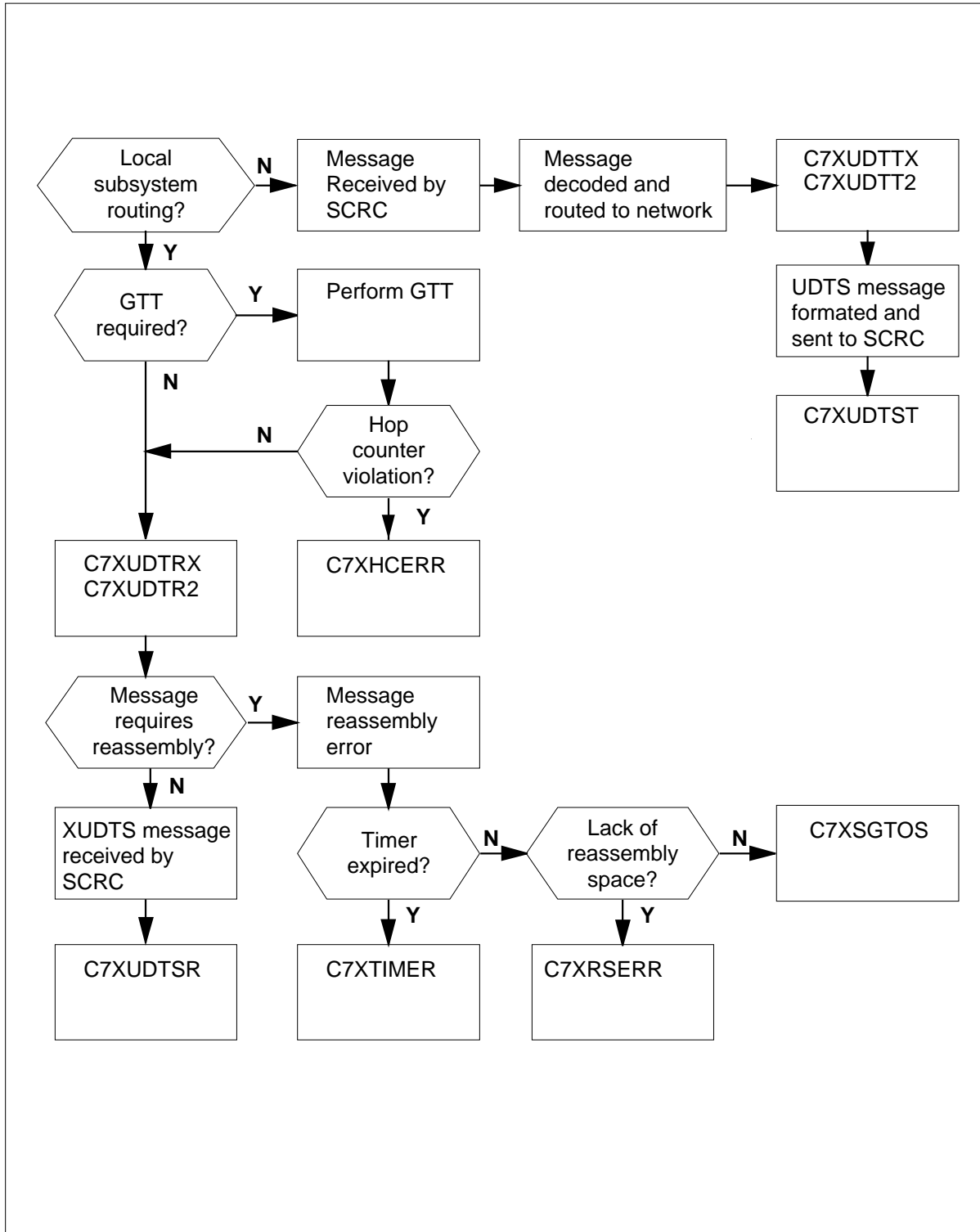
OM group C7SCCPX (continued)**OM group C7SCCPX registers**

OM group C7SCCPX (continued)

Register C7XUDTRX

Register CCS7 XUDT received

Register C7XUDTRX counts the number of extended unitdata (XUDT) SCCP messages without connections. The SCCP routing control (SCRC) receives the XUDT SCCP messages without connections from the CCS7. The XUDT messages without connections pass through the message Transfer Part (MTP)

Register C7XUDTRX release history

Register C7XUDTRX was introduced in TL06.

Associated registers

Register C7MSGHDL associates with this register.

Associated logs

There are no associated logs.

Extension registers

C7XUDTR2.

Register C7XUDTSR

Register CCS7 XUDTS received

Register C7XUDTSR counts the number of extended unitdata service(XUDTS) SCCP messages without connections. The SCCP routing control (SCRC) receives these messages from the CCS7 network through the MTP.

Register C7XUDTSR release history

Register C7XUDTSR was introduced in TL06.

Associated registers

Register C7MSGHDL associates with this register.

Associated logs

There are no associated logs.

Extension registers

There are no extension registers.

Register C7XUDTTX

Register CCS7 XUDT transmitted

OM group C7SCCPX (continued)

Register C7XUDTTX counts the number of extended unitdata (XUDT) SCCP messages without connection routed into the network through the MTP.

Register C7XUDTTX release history

Register C7XUDTTX was introduced in TL06.

Associated registers

Register C7MSGHDL associates with this register.

Associated logs

There are no associated logs.

Extension registers

C7XUDTT2.

Register C7XUDTST

Register CCS7 XUDTS transmitted

Register C7XUDTST counts the number of extended unitdata service (XUDTS) SCCP messages without connection. The system routes these messages into the network through the Message Transfer Part(MTP).

Register C7XUDTST release history

Register C7XUDTST was introduced in TL06.

Associated registers

Register C7MSGHDL associates with this register.

Associated logs

There are no associated logs.

Extension registers

There are no extension registers.

Register C7XTIMER

Register CCS7 reassembly error, timer expired (C7XTIMER)

Register C7XTIMER counts the number of extended unitdata (XUDT) SCCP messages without connections that could not be assembled again before the reassembly timer expired.

Register C7XTIMER release history

Register C7XTIMER was introduced in TL06.

OM group C7SCCPX (continued)

Associated registers

There are no associated registers.

Associated logs

There are no associated logs.

Extension registers

There are no extension registers.

Register C7XSGTOS

CCS7 reassembly error, XUDT message received out of sequence (C7XSGTOS)

Register C7XSGTOS counts the number of extended unitdata (XUDT) SCCP messages without connection that could not be reassembled. The message could not be reassembled because a segment was received out of sequence.

Register C7XSGTOS release history

Register C7XSGTOS was introduced in TL06.

Associated registers

There are no associated registers.

Associated logs

Log Number CCS201.

Extension registers

There are no associated registers.

Register C7XRSERR

Register CCS7 reassembly error, no reassembly space. (C7XRSERR)

Register C7XRSERR counts the number of extended unitdata and extended unitdata service (XUDT/XUDTS) SCCP messages without connection that could not be reassembled as a result of lack of resources.

Register C7XRSERR release history

Register C7XRSERR was introduced in TL06.

Associated registers

There are no associated registers.

OM group C7SCCPX (end)

Associated logs

Log number CCS201.

Extension registers

There are no extension registers.

Register C7XHCERR

Register CCS7 hop count violation (C7XHCERR)

Register C7XHCERR counts the number of extended unitdata and extended unitdata service (XUDT/XUDTS) SCCP messages without connections discarded as a result of a hop counter problem.

Register C7SGTOS release history

Register C7XHCERR was introduced in TL06.

Associated registers

There are no associated registers.

Associated logs

Log Number CCS241.

Extension registers

There are no extension registers.

OM group CAINAGOM

OM description

The Carrier Advanced Intelligent Network Per-Agency Operational Measurements (CAINAGOM) group provides threshold reporting of OMs on a per agency basis.

CAINAGOM consists of eight tuples:

- TOTAL - represents the sum of OM tuples pegged on a per agency basis.
- DAL - represents measurements occurring on DAL originating or terminating agencies.
- EANT - represents measurements occurring on EANT originating or terminating agencies.
- ONAL - represents measurements occurring on ONAL originating or terminating agencies.
- ONAT - represents measurements occurring on ONAT originating or terminating agencies.
- PRI - represents measurements occurring on PRI originating or terminating agencies.
- IMT - represents measurements occurring on IMT originating or terminating agencies.
- AXXESS - represents measurements occurring on AXXESS originating or terminating agencies.

Release history

Extension OM group CAINGOM2 was added for this OM group in UCS13.

Tuples ONAT and ONAL are added in UCS08.

Registers AGVIPREQ, AGVIPRSP, AGCITR, AGCIFR, AGTRCNV, AGTRCLR, TQUERY, TRESPR, TERROR, TSTRCNV, TRSCLR, TVIPREQ, and TVIPRSP are added in UCS08.

OM group CAINAGOM was introduced in UCS07.

Note: The functionality of deleted registers for UCS07 in OM group CAINOM have been captured in tuples and registers in OM group CAINAGOM for relevant per agency data.

OM group CAINAGOM (continued)

Registers

The following OM group CAINAGOM registers display on the MAP terminal as follows:

```

KEY (CAINAGOM_AGENT_TYPE)

AGQUERY  AGRESPR  AGERROR
AGEDPRCD
AGSTRCNV  AGRSCLR  AGEDPREQ
AGEDPNOT  AGVIPREQ AGVIPRSP AG-
CITR AGCIFR AGCTRCNV AGCTRCLR
  TQUERY  TRESPR
TERROR  TSTRCNV  TRSCLR  TVI-
PREQ
TVIPRSP
  
```

Group structure

OM group CAINAGOM consists of eight tuples.

Key field:

CAINAGOM_AGENT_TYPE

Info field:

None

Associated OM groups

CAINTRIG, CAINMSGS, CAINMSGR, CAINOM, CAINLNP, CAINUIF

Register AGQUERY

Register AGQUERY (Per-Agency Queries) counts the number of CAIN queries sent to the Service Control Point (SCP) on a per agency basis.

Register AGQUERY release history

Register AGQUERY was introduced in UCS07.

Associated registers

None

Associated logs

None

OM group CAINAGOM (continued)

Extension registers

Extension register AGQUERY2 in CAINGOM2 OM Group.

Register validation

None

Register AGRESPR

Register AGRESPR (Per-Agency Responses Received) counts the number of successful responses the switch receives from the SCP on a per agency basis. This trigger is pegged when the switch receives successfully decoded Analyze_Route, Disconnect, Continue, and Send_To_Resource messages and attempts the requested action.

Register AGRESPR release history

Register AGRESPR was introduced in UCS07.

Associated registers

None

Associated logs

None

Extension registers

Extension register AGRESPR2 in CAINGOM2 OM Group.

Register validation

None

Register AGERROR

Register AGERROR (Per-Agency Error Encounters) counts the number of times a CAIN fatal application error occurs on a per agency basis.

Register AGERROR release history

Register AGERROR was introduced in UCS07.

Associated registers

None

Associated logs

None

Extension registers

Extension register AGERROR2 in CAINGOM2 OM Group.

OM group CAINAGOM (continued)

Register validation

None

Register AGEDPRCD

Register AGEDPRCD (Per-Agency Event Detection Point Received) counts the number of times the switch receives a valid Request_Report_BCM_Event component on a per agency basis.

Register AGEDPRCD release history

Register AGEDPRCD was introduced in UCS07.

Associated registers

None

Associated logs

None

Extension registers

Extension register AGEDPRC2 in CAINGOM2 OM Group.

Register validation

None

Register AGSTRCNV

Register AGSTRCNV (Per-Agency Send_To_Resource Messages Received in Conversation Packages) counts the number of Send_To_Resource Messages received in conversational messages on a per agency basis.

Register AGSTRCNV release history

Register AGSTRCNV was introduced in UCS07.

Associated registers

None

Associated logs

None

Extension registers

Extension register AGSTRCN2 in CAINGOM2 OM Group.

Register validation

None

OM group CAINAGOM (continued)

Register AGRSCLR

Register AGRSCLR (Per-Agency Resource_Clear Message Sent) counts the number of Resource_Clear Messages the switch sends to the SCP during conversational messaging on a per agency basis.

Register AGRSCLR release history

Register AGRSCLR was introduced in UCS07.

Associated registers

None

Associated logs

None

Extension registers

Extension register AGRSCLR2 in CAINGOM2 OM Group.

Register validation

None

Register AGEDPREQ

Register AGEDPREQ (Per-Agency Event Detection Point Requests) counts the number of Event Detection Point Requests the switch sends to the SCP on a per agency basis.

Register AGEDPREQ release history

Register AGEDPREQ was introduced in UCS07.

Associated registers

None

Associated logs

None

Extension registers

Extension AGEDPRE2 in CAINGOM2 OM Group.

Register validation

None

OM group CAINAGOM (continued)

Register AGEDPNOT

Register AGEDPNOT (Per-Agency Event Detection Point Notification) counts the number of Event Detection Point Notification messages the switch sends to the SCP on a per agency basis.

Register AGEDPNOT release history

Register AGEDPNOT was introduced in UCS07.

Associated registers

None

Associated logs

None

Extension registers

Extension register AGEDPNO2 in CAINGOM2 OM Group.

Register validation

None

Register AGCTRCNV

Register AGCTRCNV (Per-Agency Conversational Connect to Resource Messages) counts the number of conversational Connect_To_Resource messages received by each type of CAIN agent on the SSP.

Register AGCTRCNV release history

Register AGCTRCNV was introduced in UCS08.

Associated registers

The processing of the O_Mid_Call query message can peg the following registers:

- QUERY, RESPRCVD, BLOCKED, IGNORE, NOTRIG, LEAVETDP, ERROR, NO_MATCH, CTRCONV, and CCLRCONV of OM group CAINTRIG.
- OMIDCALL and CTRCLR of OM group CAINMSGs.
- DISCON, CON2RSRC, COLLINFO, APPLERRR, FAILREPR, and REPERRR of OM group CAINMSGR.
- AGQUERY, AGRESPR, AGERROR, and AGCTRCLR of OM group CAINAGOM.

OM group CAINAGOM (continued)

Associated logs

None

Extension registers

Extension register AGCTRCN2 in CAINGOM2 OM Group.

Register validation

None

Register AGCTRCLR

Register AGCTRCLR (Per-Agency CTR_Clear Messages) counts the number of CTR_Clear messages sent by CAIN agents on the SSP.

Register AGCTRCLR release history

Register AGCTRCLR was introduced in UCS08.

Associated registers

The processing of the O_Mid_Call query message can peg the following registers:

- QUERY, RESPRCVD, BLOCKED, IGNORE, NOTRIG, LEAVETDP, ERROR, NO_MATCH, CTRCONV, and CCLRCONV of OM group CAINTRIG.
- OMIDCALL and CTRCLR of OM group CAINMSGs.
- DISCON, CON2RSRC, COLLINFO, APPLERRR, FAILREPR, and REPERRR of OM group CAINMSGR.
- AGQUERY, AGRESPR, AGERROR, and AGCTRCNV of OM group CAINAGOM.

Associated logs

None

Extension registers

Extension register AGCTRCL2 in CAINGOM2 OM Group.

Register validation

None

Register AGVIPREQ

Register AGVIPREQ (Per-Agency Virtual IP Request) counts the number of SCP requests for VIP handling through Send_To_Resource or Connect_To_Resource triggers.

OM group CAINAGOM (continued)

Register AGVIPREQ release history

Register AGVIPREQ was introduced in UCS08.

Associated registers

The processing of the Connect_To_Resource message can peg the following registers:

- QUERY, RESPRCVD, STRCONV, RCLRCONV, CCLRCONV and CTRCONV of OM group CAINTRIG.
- RSRCCLR and CTRCLR of OM group CAINMSGs.
- SND2RSRC and CON2RSRC of OM group CAINMSGR.
- AGQUERY, AGRESPR, AGSTRCNV, AGRSCLR, AGCTRCNV, and AGCTRCLR of OM group CAINAGOM.

Associated logs

None

Extension registers

None

Register validation

None

Register AGVIPRSP

Register AGVIPRSP (Per-Agency Virtual IP Response) counts the number of responses to an SCP with a normal ClearCause after VIP handling.

Register AGVIPRSP release history

Register AGVIPRSP was introduced in UCS08.

Associated registers

The processing of the Connect_To_Resource message can peg the following registers:

- QUERY, RESPRCVD, STRCONV, RCLRCONV, CCLRCONV and CTRCONV of OM group CAINTRIG.
- RSRCCLR and CTRCLR of OM group CAINMSGs.
- SND2RSRC and CON2RSRC of OM group CAINMSGR.
- AGQUERY, AGRESPR, AGSTRCNV, AGRSCLR, AGCTRCNV, and AGCTRCLR of OM group CAINAGOM.

OM group CAINAGOM (continued)

Associated logs

None

Extension registers

None

Register validation

None

Register AGCITR

Register AGCITR (Per-Agency Call_Info_To_Resource Messages Received) counts the number of Call_Info_To_Resource messages received from the SCP.

Register AGCITR release history

Register AGCITR was introduced in UCS08.

Associated registers

None

Associated logs

None

Extension registers

Extension register AGCITR2 in CAINGOM2 OM Group.

Register validation

None

Register AGCIFR

Register AGCIFR (Per-Agency Call_Info_From_Resource Messages Received) counts the number of Call_Info_From_Resource messages sent to the SCP.

Register AGCIFR release history

Register AGCIFR was introduced in UCS08.

Associated registers

None

Associated logs

None

OM group CAINAGOM (continued)

Extension registers

Extension register AGCIFR2 in CAINGOM2 OM Group.

Register validation

None

Register TQUERY

Register TQUERY (Terminating Call Model Per-Agency Queries) counts the number of terminating call model queries sent to the SCP.

Register TQUERY release history

Register TQUERY was introduced in UCS08.

Associated registers

None

Associated logs

None

Extension registers

None

Register validation

None

Register TRESPR

Register TRESPR (Terminating Call Model Per-Agency Successful Responses Received) counts the number of response messages received by the SSP in response to terminating call model queries to the SCP.

Register TRESPR release history

Register TRESPR was introduced in UCS08.

Associated registers

None

Associated logs

None

Extension registers

None

OM group CAINAGOM (continued)

Register validation

None

Register TERROR

Register TERROR (Terminating Call Model Per-Agency Errors Encountered) counts the number of times an error scenario is encountered when processing communication for a terminating call model.

Register TERROR release history

Register TERROR was introduced in UCS08.

Associated registers

None

Associated logs

None

Extension registers

None

Register validation

None

Register TSTRCNV

Register TSTRCNV (Terminating Call Model Per-Agency Send_To_Resource Messages Received In Conversation Packages) counts the number of conversational Send_To_Resource messages received by the SSP.

Register TSTRCNV release history

Register TSTRCNV was introduced in UCS08.

Associated registers

None

Associated logs

None

Extension registers

None

Register validation

None

OM group CAINAGOM (continued)

Register TRSCLR

Register TRSCLR (Terminating Call Model Per-Agency Resource_Clear Messages Sent) counts the number of Resource_Clear messages sent in conversation for CAIN terminating call models.

Register TRSCLR release history

Register TRSCLR was introduced in UCS08.

Associated registers

None

Associated logs

None

Extension registers

None

Register validation

None

Register TVIPREQ

Register TVIPREQ (Terminating Call Model Per-Agency Virtual IP Requests) counts the number of Virtual IP requests that are sent in conversation for CAIN terminating call model interactions.

Register TVIPREQ release history

Register TVIPREQ was introduced in UCS08.

Associated registers

None

Associated logs

None

Extension registers

None

Register validation

None

OM group CAINAGOM (end)

Register TVIPRSP

Register TVIPRSP (Terminating Call Model Per-Agency Virtual IP Responses) counts the number of VIP response messages sent in conversation for CAIN terminating call model interactions.

Register TVIPRSP release history

Register TVIPRSP was introduced in UCS08.

Associated registers

None

Associated logs

None

Extension registers

None

Register validation

None

OM group CAINGOM2

OM description

The Carrier Advanced Intelligent Network Per-Agency Operational Measurements (CAINGOM2) group is an extension of the OM group CAINAGOM. CAINGOM2 provides threshold reporting of OMs on a per agency basis.

CAINGOM2 consists of eight tuples:

- TOTAL - represents the sum of OM tuples pegged on a per agency basis.
- DAL - represents measurements occurring on DAL originating or terminating agencies.
- EANT - represents measurements occurring on EANT originating or terminating agencies.
- ONAL - represents measurements occurring on ONAL originating or terminating agencies.
- ONAT - represents measurements occurring on ONAT originating or terminating agencies.
- PRI - represents measurements occurring on PRI originating or terminating agencies.
- IMT - represents measurements occurring on IMT originating or terminating agencies.
- AXXESS - represents measurements occurring on AXXESS originating or terminating agencies.

Release history

OM group CAINGOM2 was introduced in UCS13.

Registers

The following OM group CAINGOM2 registers display on the MAP terminal as follows:

OM group CAINGOM2 (continued)

KEY (CAINGOM2_AGENT_TYPE)

AGQUERY2	AGRESPR2	AGERROR2
AGEDPRC2		
AGSTRCN2	AGRSCLR2	AGEDPRE2
AGEDPNO2	AGCITR2	
AGCIFR2	AGCTRCN2	AGCTRCL2

Group structure

OM group CAINGOM2 consists of eight tuples.

Key field:

CAINAGOM_AGENT_TYPE

Info field:

None

Associated OM groups

CAINTRIG, CAINMSGS, CAINMSGR, CAINOM, CAINLNP, CAINUIF

Register AGQUERY2

Register AGQUERY2 (Per-Agency Queries) is an extension register of register AGQUERY. AGQUERY2 counts the number of CAIN queries sent to the Service Control Point (SCP) on a per agency basis.

Register AGQUERY2 release history

Register AGQUERY2 was introduced in UCS13.

Associated registers

None

Associated logs

None

Extension registers

None

OM group CAINGOM2 (continued)

Register validation

None

Register AGRESPR2

Register AGRESPR2 (Per-Agency Responses Received) is an extension register of register AGRESPR. AGRESPR2 counts the number of successful responses the switch receives from the SCP on a per agency basis. This trigger is pegged when the switch receives successfully decoded Analyze_Route, Disconnect, Continue, and Send _To_Resource messages and attempts the requested action.

Register AGRESPR2 release history

Register AGRESPR2 was introduced in UCS13.

Associated registers

None

Associated logs

None

Extension registers

None

Register validation

None

Register AGERROR2

Register AGERROR2 (Per-Agency Error Encounters) is an extension register of register AGERROR. AGERROR2 counts the number of times a CAIN fatal application error occurs on a per agency basis.

Register AGERROR2 release history

Register AGERROR2 was introduced in UCS13.

Associated registers

None

Associated logs

None

Extension registers

None

OM group CAINGOM2 (continued)

Register validation

None

Register AGEDPRC2

Register AGEDPRC2 (Per-Agency Event Detection Point Received) is an extension register of register AGEDPRCD. AGEDPRC2 counts the number of times the switch receives a valid Request_Report_BCM_Event component on a per agency basis.

Register AGEDPRC2 release history

Register AGEDPRC2 was introduced in UCS13.

Associated registers

None

Associated logs

None

Extension registers

None

Register validation

None

Register AGSTRCN2

Register AGSTRCN2 (Per-Agency Send_To_Resource Messages Received in Conversation Packages) is an extension register of register AGSTRCNV. AGSTRCN2 counts the number of Send_To_Resource Messages received in conversational messages on a per agency basis.

Register AGSTRCN2 release history

Register AGSTRCN2 was introduced in UCS13.

Associated registers

None

Associated logs

None

Extension registers

None

OM group CAINGOM2 (continued)

Register validation

None

Register AGRSCLR2

Register AGRSCLR2 (Per-Agency Resource_Clear Message Sent) is an extension register of register AGRSCLR. AGRSCLR2 counts the number of Resource_Clear Messages the switch sends to the SCP during conversational messaging on a per agency basis.

Register AGRSCLR2 release history

Register AGRSCLR2 was introduced in UCS13.

Associated registers

None

Associated logs

None

Extension registers

None

Register validation

None

Register AGEDPRE2

Register AGEDPRE2 (Per-Agency Event Detection Point Requests) is an extension register of register AGEDPREQ. AGEDPRE2 counts the number of Event Detection Point Requests the switch sends to the SCP on a per agency basis.

Register AGEDPRE2 release history

Register AGEDPRE2 was introduced in UCS13.

Associated registers

None

Associated logs

None

Extension registers

None

OM group CAINGOM2 (continued)

Register validation

None

Register AGEDPNO2

Register AGEDPNO2 (Per-Agency Event Detection Point Notification) is an extension register of register AGEDPNOT. AGEDPNO2 counts the number of Event Detection Point Notification messages the switch sends to the SCP on a per agency basis.

Register AGEDPNO2 release history

Register AGEDPNO2 was introduced in UCS13.

Associated registers

None

Associated logs

None

Extension registers

None

Register validation

None

Register AGCTRCN2

Register AGCTRCN2 (Per-Agency Conversational Connect to Resource Messages) is an extension register of register AGCTRCNV. AGCTRCN2 counts the number of conversational Connect_To_Resource messages received by each type of CAIN agent on the SSP.

Register AGCTRCN2 release history

Register AGCTRCN2 was introduced in UCS13.

Associated registers

The processing of the O_Mid_Call query message can peg the following registers:

- QUERY, RESPRCVD, BLOCKED, IGNORE, NOTRIG, LEAVETDP, ERROR, NO_MATCH, CTRCONV, and CCLRCONV of OM group CAINTRIG.
- OMIDCALL and CTRCLR of OM group CAINMSGSGS

OM group CAINGOM2 (continued)

- DISCON, CON2RSRC, COLLINFO, APPLERRR, FAILREPR, and REPERRR of OM group CAINMSGR.
- AGQUERY2, AGRESPR2, AGERROR2, and AGCTRCL2 of OM group CAINGOM2.

Associated logs

None

Extension registers

None

Register validation

None

Register AGCTRCL2

Register AGCTRCL2 (Per-Agency CTR_Clear Messages) is an extension register of register AGCTRCLR. AGCTRCL2 counts the number of CTR_Clear messages sent by CAIN agents on the SSP.

Register AGCTRCL2 release history

Register AGCTRCL2 was introduced in UCS13.

Associated registers

The processing of the O_Mid_Call query message can peg the following registers:

- QUERY, RESPRCVD, BLOCKED, IGNORE, NOTRIG, LEAVETDP, ERROR, NO_MATCH, CTRCONV, and CCLRCONV of OM group CAINTRIG.
- OMIDCALL and CTRCLR of OM group CAINMSGs.
- DISCON, CON2RSRC, COLLINFO, APPLERRR, FAILREPR, and REPERRR of OM group CAINMSGR.
- AGQUERY2, AGRESPR2, AGERROR2, and AGCTRCN2 of OM group CAINGOM2.

Associated logs

None

Extension registers

None

OM group CAINGOM2 (end)

Register validation

None

Register AGCITR2

Register AGCITR2 (Per-Agency Call_Info_To_Resource Messages Received) is an extension register of register AGCITR. AGCITR2 counts the number of Call_Info_To_Resource messages received from the SCP.

Register AGCITR2 release history

Register AGCITR2 was introduced in UCS13.

Associated registers

None

Associated logs

None

Extension registers

None

Register validation

None

Register AGCIFR2

Register AGCIFR2 (Per-Agency Call_Info_From_Resource Messages Received) is an extension register of register AGCIFR. AGCIFR2 counts the number of Call_Info_From_Resource messages sent to the SCP.

Register AGCIFR2 release history

Register AGCIFR2 was introduced in UCS13.

Associated registers

None

Associated logs

None

Extension registers

None

Register validation

None

OM group CAINIP

OM description

The Carrier AIN 1129-style IP Interactions group provides OMs for ClearCause values in a Resource_Clear message. This group also tracks the number of times the TSTRC and TDISC timers expired at the local SSP.

Release history

OM group CAINIP was introduced in UCS08.

Registers

The following OM group CAINIP registers display on the MAP terminal as follows:

IPNORMAL	IPTMO	IPRESCAN	IPUANLEG
IPINVLEG	IPUABNDN	IPINVCOD	IPFAIL
IPCHBSY	IPRESNAV	IPISDNTD	IPRESTNS
IPTSFRFS	IPINVCRS	IPCAPFL	IPPROTER
IPABORT	IPSUPINV	IPSTRCAN	IPTMPFL
IPIPTMO	IPCTRCAN	IPTSTRC	IPTDISC

Group structure

OM group CAINIP

Key field:

None

Info field:

None

Register IPNORMAL

Register IPNORMAL (IP Resource_Clear Messages Sent With ClearCause Value: normal) counts the number of Resource_Clear messages with a ClearCause value of "normal".

Register IPNORMAL release history

Register IPNORMAL was introduced in UCS08.

OM group CAINIP (continued)

Associated registers

None

Associated logs

None

Extension registers

None

Register IPTMO

Register IPTMO (IP Resource_Clear Messages Sent With ClearCause Value: timeout) counts the number of Resource_Clear messages with a ClearCause value of "timeout".

Register IPTMO release history

Register IPTMO was introduced in UCS08.

Associated registers

None

Associated logs

None

Extension registers

None

Register IPRESCAN

Register IPRESCAN (IP Resource_Clear Messages Sent With ClearCause Value: resourceCancelled) counts the number of Resource_Clear messages with a ClearCause value of "resourceCancelled".

Register IPRESCAN release history

Register IPRESCAN was introduced in UCS08.

Associated registers

None

Associated logs

None

Extension registers

None

OM group CAINIP (continued)

Register IPUANLEG

Register IPUANLEG (IP Resource_Clear Messages Sent With ClearCause Value: unansweredLeg) counts the number of Resource_Clear messages with a ClearCause value of "unansweredLeg".

Register IPUANLEG release history

Register IPUANLEG was introduced in UCS08.

Associated registers

None

Associated logs

None

Extension registers

None

Register IPINVLEG

Register IPINVLEG (IP Resource_Clear Messages Sent With ClearCause Value: invalidLeg) counts the number of Resource_Clear messages with a ClearCause value of "invalidLeg".

Register IPINVLEG release history

Register IPINVLEG was introduced in UCS08.

Associated registers

None

Associated logs

None

Extension registers

None

Register IPUABNDN

Register IPUABNDN (IP Resource_Clear Messages Sent With ClearCause Value: userAbandon) counts the number of Resource_Clear messages with a ClearCause value of "userAbandon".

Register IPUABNDN release history

Register IPUABNDN was introduced in UCS08.

OM group CAINIP (continued)

Associated registers

None

Associated logs

None

Extension registers

None

Register IPINVCOD

Register IPINVCOD (IP Resource_Clear Messages Sent With ClearCause Value: invalidCode) counts the number of Resource_Clear messages with a ClearCause value of "invalidCode".

Register IPINVCOD release history

Register IPINVCOD was introduced in UCS08.

Associated registers

None

Associated logs

None

Extension registers

None

Register IPFAIL

Register IPFAIL (IP Resource_Clear Messages Sent With ClearCause Value: failure) counts the number of Resource_Clear messages with a ClearCause value of "failure".

Register IPFAIL release history

Register IPFAIL was introduced in UCS08.

Associated registers

None

Associated logs

None

Extension registers

None

OM group CAINIP (continued)

Register IPCHBSY

Register IPCHBSY (IP Resource_Clear Messages Sent With ClearCause Value: channelsBusy) counts the number of Resource_Clear messages with a ClearCause value of "channelsBusy".

Register IPCHBSY release history

Register IPCHBSY was introduced in UCS08.

Associated registers

None

Associated logs

None

Extension registers

None

Register IPRESNAV

Register IPRESNAV (IP Resource_Clear Messages Sent With ClearCause Value: resourcesNotAvailable) counts the number of Resource_Clear messages with a ClearCause value of "resourcesNotAvailable".

Register IPRESNAV release history

Register IPRESNAV was introduced in UCS08.

Associated registers

None

Associated logs

None

Extension registers

None

Register IPISDNTO

Register IPISDNTO (IP Resource_Clear Messages Sent With ClearCause Value: isdnTimeout) counts the number of Resource_Clear messages with a ClearCause value of "isdnTimeout".

Register IPISDNTO release history

Register IPISDNTO was introduced in UCS08.

OM group CAINIP (continued)

Associated registers

None

Associated logs

None

Extension registers

None

Register IPRESTNS

Register IPRESTNS (IP Resource_Clear Messages Sent With ClearCause Value: resourceTypeNotSupported) counts the number of Resource_Clear messages with a ClearCause value of "resourceTypeNotSupported".

Register IPRESTNS release history

Register IPRESTNS was introduced in UCS08.

Associated registers

None

Associated logs

None

Extension registers

None

Register IPTSKRFS

Register IPTSKRFS (IPTSKRFS IP Resource_Clear Messages Sent With ClearCause Value: taskRefused) counts the number of Resource_Clear messages with a ClearCause value of "taskRefused".

Register IPTSKRFS release history

Register IPTSKRFS was introduced in UCS08.

Associated registers

None

Associated logs

None

Extension registers

None

OM group CAINIP (continued)

Register IPINVCRS

Register IPINVCRS (IP Resource_Clear Messages Sent With ClearCause Value: invalidCallerResponse) counts the number of Resource_Clear messages with a ClearCause value of "invalidCallerResponse".

Register IPINVCRS release history

Register IPINVCRS was introduced in UCS08.

Associated registers

None

Associated logs

None

Extension registers

None

Register IPCAPFL

Register IPCAPFL (IP Resource_Clear Messages Sent With ClearCause Value: capabilityFailure) counts the number of Resource_Clear messages with a ClearCause value of "capabilityFailure".

Register IPCAPFL release history

Register IPCAPFL was introduced in UCS08.

Associated registers

None

Associated logs

None

Extension registers

None

Register IPPROTER

Register IPPROTER (IP Resource_Clear Messages Sent With ClearCause Value: protocolError) counts the number of Resource_Clear messages with a ClearCause value of "protocolError".

Register IPPROTER release history

Register IPPROTER was introduced in UCS08.

OM group CAINIP (continued)

Associated registers

None

Associated logs

None

Extension registers

None

Register IPABORT

Register IPABORT (IP Resource_Clear Messages Sent With ClearCause Value: abort) counts the number of Resource_Clear messages with a ClearCause value of "abort".

Register IPABORT release history

Register IPABORT was introduced in UCS08.

Associated registers

None

Associated logs

None

Extension registers

None

Register IPSUPINV

Register IPSUPINV (IP Resource_Clear Messages Sent With ClearCause Value: suppServiceInvoked) counts the number of Resource_Clear messages with a ClearCause value of "suppServiceInvoked".

Register IPSUPINV release history

Register IPSUPINV was introduced in UCS08.

Associated registers

None

Associated logs

None

Extension registers

None

OM group CAINIP (continued)

Register IPSTRCAN

Register IPSTRCAN (IP Resource_Clear Messages Sent With ClearCause Value: strCancelled) counts the number of Resource_Clear messages with a ClearCause value of "strCancelled".

Register IPSTRCAN release history

Register IPSTRCAN was introduced in UCS08.

Associated registers

None

Associated logs

None

Extension registers

None

Register IPTMPFL

Register IPTMPFL (IP Resource_Clear Messages Sent With ClearCause Value: temporaryFailure) counts the number of Resource_Clear messages with a ClearCause value of "temporaryFailure".

Register IPTMPFL release history

Register IPTMPFL was introduced in UCS08.

Associated registers

None

Associated logs

None

Extension registers

None

Register IPIPTMO

Register IPIPTMO (IP Resource_Clear Messages Sent With ClearCause Value: ipTimeout) counts the number of Resource_Clear messages with a ClearCause value of "ipTimeout".

Register IPIPTMO release history

Register IPIPTMO was introduced in UCS08.

OM group CAINIP (continued)

Associated registers

None

Associated logs

None

Extension registers

None

Register IPCTRCAN

Register IPCTRCAN (IP Resource_Clear Messages Sent With ClearCause Value: ctrCancelled) counts the number of Resource_Clear messages with a ClearCause value of "ctrCancelled".

Register IPCTRCAN release history

Register IPCTRCAN was introduced in UCS08.

Associated registers

None

Associated logs

None

Extension registers

None

Register IPTSTRC

Register IPTSTRC (Number of times TSTRC timer has expired) counts the number of times the TSTRC timer has expired.

Register IPTSTRC release history

Register IPTSTRC was introduced in UCS08.

Associated registers

None

Associated logs

None

Extension registers

None

OM group CAINIP (end)

Register IPTDISC

Register IPTDISC (Number of times TDISC timer has expired) counts the number of times the TDISC timer has expired.

Register IPTDISC release history

Register IPTDISC was introduced in UCS08.

Associated registers

None

Associated logs

None

Extension registers

None

OM group CAINLNP

OM description

Carrier AIN Local Number Portability (CAINLNP) group provides OMs to track Local Number Portability functionality on a Carrier Advanced Intelligent Network.

Release history

The following extension registers were added for UCS13:

- OFCDLOO2
- LNPQUER2
- LRNONLN2
- INLNPN2
- LNPDISC2
- DESTFAI2
- BLKBYST2
- TERMLRN2

Register TERMLRN (AX1250) was added in UCS09.

Registers BADGAP and BLKBYSTS are introduced in UCS08.

OM group CAINLNP was introduced in UCS07.

Registers

The OM group CAINLNP registers display on the MAP terminal as follows:

KEY (COMMON_LANGUAGE_NAME)				
BLKBYSTS	DESTFAIL	INLNPNF	LNPDISC	LNPQUERY
LRNONLNP	OFCDLOOK	TERMLRN	BADGAP	
BLKBYST2	DESTFAI2	INLNPN2	LNPDISC2	LNPQUER2
LRNONLN2	OFCDLOO2	TERMLRN2		

Group structure

OM group CAINLNP tuples are allocated on a per trunk group basis.

OM group CAINLNP (continued)

Key field:

COMMON_LANGUAGE_NAME

Info field:

None

Associated OM groups

None

Register OFCDLOOK

Register OFCDLOOK (Office Code Lookup) is pegged when a call subscribes to the OFFCCODE trigger and the OFFCCODE table is referenced to determine whether a match is made.

Register OFCDLOOK release history

Register OFCDLOOK was introduced in UCS07.

Associated registers

None

Associated logs

None

Extension registers

OFCDLOO2

Register LNPQUERY

Register LNPQUERY (Local Number Portability Query) is pegged when the Service Switching Point (SSP) queries the Service Control Point (SCP) for LNP information.

Register LNPQUERY release history

Register LNPQUERY was introduced in UCS07.

Associated registers

None

Associated logs

None

OM group CAINLNP (continued)

Extension registers

LNPQUER2

Register LRNONLNP

Register LRNONLNP (Local Routing Number On Local Number Portability) is pegged when an LNPQUERY is made to the SCP and a response message is received containing the Local Routing Number (LRN) to be used for the call.

Register LRNONLNP release history

Register LRNONLNP was introduced in UCS07.

Associated registers

None

Associated logs

None

Extension registers

LRNONLN2

Register INLNPF

Register INLNPF (Incoming Local Number Portability Information) is pegged when the FCI bits on an incoming ISUP call indicate that LNP has been performed by a previous switch.

Register INLNPF release history

Register INLNPF was introduced in UCS07.

Associated registers

None

Associated logs

None

Extension registers

INLNPF2

Register LNPDISC

Register LNPDISC (Local Number Portability Discarded) is pegged when LNP has been performed, but the information obtained must be discarded, since the terminating agent leaving the current switch is not ISUP.

LNPDISC will also occur if the terminating call is an ISUP call, but has

OM group CAINLNP (continued)

option SIGPTDNO datafilled against it in table TRKGRP or table TRKFEAT (for AXXESS agents).

Register LNPDISC release history

Register LNPDISC was introduced in UCS07.

Associated registers

None

Associated logs

None

Extension registers

LNPDISC2

Register DESTFAIL

Register DESTFAIL (Destination Failed) is pegged when the release cause Ported_Dest_Failed is received by the switch that performed the query. The Ported_Dest_Failed is received when the terminating switch could not find the subscriber whose address was in the LNP GAP parameter.

Register DESTFAIL release history

Register DESTFAIL was introduced in UCS07.

Associated registers

None

Associated logs

None

Extension registers

DESTFAI2

Register BADGAP

Register BADGAP (Bad Generic Address Parameter) is pegged when the DMS switch receives a release message with a release cause of 28 indicating that an incorrectly encoded LNP GAP parameter was detected when this OM register is pegged. This is only true when LNP is active at this switch. The active status indicates an incoming LNP GAP received or one sent by the Service Control Point. In either case, the LNP GAP was sent in the outgoing Initial Address Message (IAM).

OM group CAINLNP (continued)

Register **BADGAP** release history

Register BADGAP was introduced in UCS08.

Associated registers

None

Associated logs

None

Extension registers

None

Register **BLKBYSTS**

When the OFFCCODE trigger detection point is encountered, table CAINSTS is referenced to determine if the NO_LNP option is datafilled against the STS. Register BLKBYSTS (Block by Serving Translation Scheme) is pegged when the OFFCCODE LNP query is not allowed to take place. Otherwise, the LNP query takes place as normal without pegging this OM.

Register **BLKBYSTS** release history

Register BLKBYSTS was introduced in UCS08.

Associated registers

None

Associated logs

CAIN906

Extension registers

BLKBYST2

Register **TERMLRN**

Register TERMLRN (Terminating LRN recognized call). Register TERMLRN is pegged when the switch processes a terminating LRN for a call that matches its own.

Register **TERMLRN** release history

Register TERMLRN was created in UCS09.

Associated registers

None

OM group CAINLNP (end)

Associated logs

CAIN906

Extension registers

TERMLNR2

OM group CAINMGR2

OM description

The Carrier AIN Messages Received (CAINMGR2) group is an extension OM group of CAINMSGR. CAINMGR2 reports the number of CAIN TCAP messages received from the Service Control Point (SCP) related to call processing.

Release history

Register FAMINF2 was added in UCS14 (A60008668).

CAINMGR2 OM group was added in UCS13.

Registers

The OM group CAINMGR2 registers display on the MAP terminal as follows:

ANLZRTE2	CONTINU2	SND2RSR2	CANCRSR2
RRBCMEV2	CITRSC2	AUTHTER2	COLLINF2
CON2RSR2	SENDNOT2	ACG2	TR533R2
FAMAINF2			

Group structure

OM group CAINMGR2 consists of one tuple.

Key field:

None

Info field:

None

Associated OM groups

CAINTRIG, CAINMSGs, CAINLNP, CAINUIF, CAINAGOM, CAINOM, VPTRUSAG, VTCAPERRS, TFREE533.

Register ANLZRTE2

Register ANLZRTE2 (Analyze_Route Message) is an extension register of register ANLZRTE. ANLZRTE2 counts the number of *Analyze_Route* messages the switch receives from the SCP.

Register ANLZRTE2 release history

Register ANLZRTE2 was introduced in UCS13.

OM group CAINMGR2 (continued)

Associated registers

None

Associated logs

None

Extension registers

None

Register validation

None

Register CONTINU2

Register CONTINU2 (CONTINU2 Message) is an extension register of register CONTINUE. CONTINU2 counts the number of *CONTINU2* messages the switch receives from the SCP.

Register CONTINU2 release history

Register CONTINU2 was introduced in UCS13.

Associated registers

None

Associated logs

None

Extension registers

None

Register validation

None

Register SND2RSR2

Register SND2RSR2 (Send_To_Resource Message) is an extension register of register SND2RSRC. SND2RSR2 counts the number of *Send_To_Resource* messages the switch receives from the SCP.

Register SND2RSR2 release history

Register SND2RSR2 was introduced in UCS13.

Associated registers

None

OM group CAINMGR2 (continued)

Associated logs

None

Extension registers

None

Register validation

None

Register CANCRSR2

Register CANCRSR2 (Cancel_Resource_Event Message) is an extension register of register CANCRSRC. CANCRSR2 counts the number of *Cancel_Resource_Event* messages the switch receives from the SCP.

Register CANCRSR2 release history

Register CANCRSR2 was introduced in UCS13.

Associated registers

None

Associated logs

None

Extension registers

None

Register RRBCMEV2

Register RRBCMEV2 (Request_Report_BCM_Event Message) is an extension register of register RRBCMEVT. RRBCMEV2 counts the number of *Request_Report_BCM_Event* messages the switch receives from the SCP.

Register RRBCMEV2 release history

Register RRBCMEV2 was introduced in UCS13.

Associated registers

None

Associated logs

None

Extension registers

None

OM group CAINMGR2 (continued)

Register COLLINF2

Register COLLINF2 (Collect_Information Messages) is an extension register of register COLLINFO. COLLINF2 counts the number of Collect_Information messages received by the SSP.

Register COLLINF2 release history

Register COLLINFO was introduced in UCS13.

Associated registers

The processing of the Collect_Information message can peg the following registers:

- QUERY, RESPRCVD, BLOCKED, IGNORE, NOTRIG, LEAVETDP, ERROR, NO_MATCH, CTRCONV, and CCLRCONV of OM group CAINTRIG.
- CTRCLR and OMIDCALL of OM group CAINMSGs.
- DISCON, CON2RSR2, APPLERRR, FAILREPR, and REPERRR of OM group CAINMGR2.
- AGQUERY, AGRESPR, AGERROR, AGCTRCNV, and AGCTRCLR of OM group CAINAGOM.

Associated logs

None

Extension registers

None

Register CON2RSR2

Register CON2RSR2 (Connect to Resource Messages) is an extension register of register CON2RSRC counts the number of Connect_To_Resource messages received by the SSP.

Register CON2RSR2 release history

Register CON2RSR2 was introduced in UCS13.

Associated registers

The processing of the Connect_To_Resource message can peg the following registers:

- QUERY, RESPRCVD, BLOCKED, IGNORE, NOTRIG, LEAVETDP, ERROR, NO_MATCH, CTRCONV, and CCLRCONV of OM group CAINTRIG.
- CTRCLR and OMIDCALL of OM group CAINMSGs.

OM group CAINMGR2 (continued)

- DISCON, COLLINF2, APPLERRR, FAILREPR, and REPERRR of OM group CAINMGR2.
- AGQUERY, AGRESPR, AGERROR, AGCTRCNV, and AGCTRCLR of OM group CAINAGOM.

Associated logs

None

Extension registers

None

Register CISTRSC2

Register CISTRSC2 (Call Info to Resource Messages) counts the number of Call_Info_To_Resource messages received from the SCP.

Register CISTRSC2 release history

Register CISTRSC2 was introduced in UCS13.

Associated registers

None

Associated logs

None

Extension registers

None

Register AUTHTER2

Register AUTHTER2 (Authorize Termination Messages) is an extension register of register AUTHTERM. AUTHTER2 counts the number of Authorize_Termination messages received by the SSP.

Register AUTHTER2 release history

Register AUTHTER2 was introduced in UCS13.

Associated registers

The processing of the Authorize_Termination query message can peg the following registers:

- QUERY and ERROR of OM group CAINTRIG.
- TERMATT of OM group CAINMSGS.
- TQUERY, TRESPR and TERROR of OM group CAINAGOM.

OM group CAINMGR2 (continued)

Associated logs

None

Extension registers

None

Register SENDNOT2

Register SENDNOT2 (Send_Notification message) is an extension register of register SENDNOT. SENDNOT2 counts the number of Send_Notification messages received by the Service Switching Point (SSP).

Register SENDNOT2 release history

Register SENDNOT2 was introduced in UCS13.

Associated registers

None

Associated logs

None

Extension registers

None

Register ACG2

Register ACG2 (Automatic Code Gapping) is an extension register of register ACG. Register ACG2 counts the number of ACG2 messages received by the Service Switching Point.

Register ACG2 release history

Register ACG2 was created in UCS13.

Associated registers

Not applicable

Associated logs

Not applicable

Extension registers

None

OM group CAINMGR2 (end)

Register TR533R2

Register TR533R2 (Toll-free messages received) is an extension register of register TR533R. This OM group supports the Bellcore TR-NWT-000533 specifications for the DMS-250 switch.

Register TR533R2 release history

Register TR533R2 was added in UCS13.

Associated registers

The registers in OM group TFREE533 peg more specific behavior of the Toll-Free Services interactions.

Associated logs

Not applicable

Extension registers

None

Register FAMAINF2

Register FAMAINF2 (Furnish AMA Information 2). Register FAMAINF2 is an extension register of register FAMAINFO. Register FAMAINF2 is pegged when register FAMAINFO exceeds its limits.

Register FAMAINF2 release history

Register FAMAINF2 was added in UCS14.

Associated register

FAMAINFO

Associated logs

None

Extension registers

None

OM group CAINMGS2

OM description

The Carrier AIN Message Sent (CAINMGS2) group is an extension OM group of CAINMSGs. CAINMGS2 provides OMs for TCAP messages sent to the Service Control Point (SCP) for CAIN processing.

Release history

OM group CAINMGS2 was introduced in UCS13.

Registers

The OM group CAINMGS2 registers display on the MAP terminal as follows:

ORIGATT2	O_FTRRE2	INFOCOL2	INFOANL2
NETWBUS2	OCLDBUS2	O_NOANS2	
			R.SRCCLR2
OTERMSZ2	OANSWR2	TIMEOUT2	ODISC2
CIFRSC2	TERMATT2	OMIDCAL2	CTRCLR2
TR533S2			

Note: To display all registers within the same OM group requires issuing the OMSHOW command twice. For example: OMSHOW CAINMSGs active and OMSHOW CAINMGS2 active display all registers in OM groups CAINMSGs and CAINMGS2.

Group structure

OM group CAINMGS2 consists of one tuple.

Key field:

None

Info field:

None

Associated OM groups

CAINTRIG, CAINOM, CAINAGOM, CAINMSGR, CAINAGOM, CAINUIF, CAINLNP, VPTRUSAG, VTCAPERRS, TFREE533.

OM group CAINMGS2 (continued)

Register ORIGATT2

Register ORIGATT2 (Origination_Attempt Message) is an extension register of register ORIGATT. ORIGATT2 counts the number of *Origination_Attempt* messages sent to the Service Control Point (SCP).

Register ORIGATT2 release history

Register ORIGATT2 was introduced in UCS13.

Associated registers

None

Associated logs

None

Extension registers

None

Register validation

None

Register O_FTRRE2

Register O_FTRRE2 (O_Feature_Requested Message) is an extension register of register O_FTRREQ. O_FTRRE2 counts the number of *O_Feature_Requested* messages sent to the SCP.

Register O_FTRRE2 release history

Register O_FTRRE2 was introduced in UCS13.

Associated registers

None

Associated logs

None

Extension registers

None

Register validation

None

OM group CAINMGS2 (continued)

Register INFOCOL2

Register INFOCOL2 (Info_Collected Message) is an extension register of register INFOCOLL. INFOCOL2 counts the number of *Info_Collected* messages sent to the SCP.

Register INFOCOL2 release history

Register INFOCOL2 was introduced in UCS13.

Associated registers

None

Associated logs

None

Extension registers

None

Register validation

None

Register INFOANL2

Register INFOANL2 (Info_Analyzed Message) is an extension register of register INFOANLZ. INFOANL2 counts the number of *Info_Analyzed* messages sent to the SCP by the UCS DMS-250 switch.

Register INFOANL2 release history

Register INFOANL2 was introduced in UCS13.

Associated registers

None

Associated logs

None

Extension registers

None

Register validation

None

OM group CAINMGS2 (continued)

Register NETWBUS2

Register NETWBUS2 (Network_Busy Message) is an extension register of register NETWBUSY. NETWBUS2 counts the number of *Network_Busy* messages sent to the SCP.

Register NETWBUS2 release history

Register NETWBUS2 was introduced in UCS13.

Associated registers

None

Associated logs

None

Extension registers

None

Register validation

None

Register OCLDBUS2

Register OCLDBUS2 (O_Called_Party_Busy Message) is an extension register of register OCLDBUSY. OCLDBUS2 counts the number of *O_Called_Party_Busy* messages sent to the SCP.

Register OCLDBUS2 release history

Register OCLDBUS2 was introduced in UCS13.

Associated registers

None

Associated logs

None

Extension registers

None

Register validation

None

Register O_NOANS2

Register O_NOANS2 (O_No_Answer Message) counts the number of *O_No_Answer* messages sent to the SCP.

OM group CAINMGS2 (continued)

Register O_NOANS2 release history

Register O_NOANS2 was introduced in UCS13.

Associated registers

None

Associated logs

None

Extension registers

None

Register validation

None

Register RSRCCLR2

Register RSRCCLR2 (Resource_Clear Message) is an extension register of register RSRCCLR. RSRCCLR2 counts the number of *Resource_Clear* messages sent to the SCP.

Register RSRCCLR2 release history

Register RSRCCLR2 was introduced in UCS13.

Associated registers

None

Associated logs

None

Extension registers

None

Register validation

None

Register OTERMSZ2

Register OTERMSZ2 (O_Term_Seized Message) is an extension register of register OTERMSZ. OTERMSZ2 counts the number of *O_Term_Seized* messages sent by the SSP.

Register OTERMSZ2 release history

Register OTERMSZ2 was introduced in UCS13.

OM group CAINMGS2 (continued)

Associated registers

None

Associated logs

None

Extension registers

None

Register validation

None

Register OANSWR2

Register OANSWR2 (O_Answer Message) is an extension register of register OANWR. OANSWR2 counts the number of *O_Answer* messages sent by the SSP.

Register OANSWR2 release history

Register OANSWR2 was introduced in UCS13.

Associated registers

None

Associated logs

None

Extension registers

None

Register validation

None

Register OMIDCAL2

Register OMIDCAL2 (O_Mid_Call Messages) is an extension register of register OMIDCALL. OMIDCAL2 counts the number of O_Mid_Call query messages sent by the SSP.

Register OMIDCAL2 release history

Register OMIDCAL2 was introduced in UCS13.

OM group CAINMGS2 (continued)

Associated registers

The processing of the O_Mid_Call query message can peg the following registers:

- QUERY, RESPRCVD, BLOCKED, IGNORE, NOTRIG, LEAVETDP, ERROR, NO_MATCH, CTRCONV, and CCLRCONV of OM group CAINTRIG.
- CTRCLR2 of OM group CAINMGS2.
- DISCON, CON2RSRC, COLLINFO, APPLERRR, FAILREPR, and REPERRR of OM group CAINMSGR.
- AGQUERY, AGRESPR, AGERROR, AGCTRCNV, and AGCTRCLR2 of OM group CAINAGOM.

Associated logs

None

Extension registers

None

Register CTRCLR2

Register CTRCLR2 (CTR_Clear Messages) is an extension register of register CTRCLR. CTRCLR2 counts the number of CTR_Clear messages sent by the SSP.

Register CTRCLR2 release history

Register CTRCLR2 was introduced in UCS13.

Associated registers

The processing of the CTR_Clear message can peg the following registers:

- QUERY, RESPRCVD, BLOCKED, IGNORE, NOTRIG, LEAVETDP, ERROR, NO_MATCH, CTRCONV, and CCLRCONV of OM group CAINTRIG.
- OMIDCAL2 of OM group CAINMGS2.
- DISCON, CON2RSRC, COLLINFO, APPLERRR, FAILREPR, and REPERRR of OM group CAINMSGR.
- AGQUERY, AGRESPR, AGERROR, AGCTRCNV, and AGCTRCLR2 of OM group CAINAGOM.

Associated logs

None

OM group CAINMGS2 (continued)

Extension registers

None

Register CIFRSC2

Register CIFRSC2 (Call Info From Resource Message) is an extension register of register CIFRSC. CIFRSC2 counts the number of Call_Info_From_Resource messages sent (on a per switch basis) to the SCP.

Register CIFRSC2 release history

Register CIFRSC2 was introduced in UCS13.

Associated registers

None

Associated logs

None

Extension registers

None

Register TERMATT2

Register TERMATT2 (Termination Attempt) is an extension register of register TERMATT. TERMATT2 counts the number of Termination_Attempt messages sent by the SSP.

Register TERMATT2 release history

Register TERMATT2 was introduced in UCS13.

Associated registers

The processing of the Termination_Attempt query message can peg the following registers:

- QUERY, RESPRCVD, BLOCKED, IGNORE, NOTRIG, LEAVETDP, ERROR, NO_MATCH, STRCONV and RCLRCONV of OM group CAINTRIG.
- CAINMSGR registers: DISCON, SND2RSRC, APPLERRR, FAILREPR, REPERRR and AUTHTERM of OM group CAINMSGR.
- CAINAGOM registers: TQUERY, TRESPR, TERROR, TSTRCNV, TRSCLR, TVIPREQ and TVIPRSP of OM group CAINAGOM.

Associated logs

None

OM group CAINMGS2 (continued)

Extension registers

None

Register TIMEOUT2

Register TIMEOUT2 (Timeout Messages) counts the number of Timeout Messages sent by the SSP

Register TIMEOUT2 release history

Register TIMEOUT2 was introduced in UCS13.

Associated registers

The processing of the Timeout message can peg the following registers:

- ERROR and EDPREQ of OM group CAINTRIG.
- AGEDPREQ and AGERROR of OM group CAINAGOM.

Associated logs

None

Extension registers

None

Register ODISC2

Register ODISC2 (O_Disconnect Message) counts the number of O_Disconnect Messages sent by the SSP.

Register ODISC2 release history

Register ODISC2 was introduced in UCS13.

Associated registers

The processing of the O_Disconnect message can peg the following registers:

- ERROR, EDPNOTIF and EDPREQ of OM group CAINTRIG
- AGEDPNOT, AGERROR and AGEDPREQ of OM group CAINAGOM

Associated logs

None

Extension registers

None

OM group CAINMGS2 (end)

Register TR533S2

Register TR533S2 (Toll-Free Services Messages sent). This OM group supports the Bellcore TR-NWT-000533 specifications for the DMS-250.

Register TR533S2 release history

Register TR533S2 was introduced in UCS13.

Associated registers

The registers in OM group TFREE533 peg more specific behavior of the Toll-Free Services interactions.

Associated logs

Not applicable

Extension registers

None

OM group CAINMSGR

OM description

The Carrier AIN Messages Received (CAINMSGR) group reports the number of CAIN TCAP messages received from the Service Control Point (SCP) related to call processing.

Release history

Register FAMAINFO was added in UCS14 (A60008668).

Extension OM group, CAINMGR2 was added in UCS13 for the following registers:

- ACG
- ANLZRTE
- AUTHTERM
- CANCRSRC
- CITRSC
- COLLINFO
- CON2RSRC
- CONTINUE
- RRBCMEVT
- SND2RSRC
- SENDNOT
- TR533R

Registers ORIGCALL, MERGECL, ACKNOW and DISCLEG were added in UCS11 (AX1372).

Registers SENDNOT (AX0972), ACG (AX0976), ACGRESTR (AX0976) and TR533R (AX1377) were added in UCS09.

Registers AUTHTERM, CITRSC, COLLINFO, and CON2RSRC are added in UCS08

OM group CAINMSGR was introduced in UCS07.

Note: Prior to UCS07, the registers in OM group CAINMSGR were part of OM group CAINMSGs.

OM group CAINMSGR (continued)

Registers

The OM group CAINMSGR registers display on the MAP terminal as follows:

ANLZRTE	CONTINUE	DISCON	SND2RSRC
FAILREPR	REPERRR	CLOSER	APPLERRR
CANCRSRC	RRBCMEVT	CITRSC	AUTHTERM
COLLINFO	CON2RSRC	SENDNOT	ACG
ACGRESTR	TR533R	ORIGCALL	MERGECL
DISCLEG	ACKNOW	FAMAINFO	

Group structure

OM group CAINMSGR consists of one tuple.

Key field:

None

Info field:

None

Associated OM groups

CAINTRIG, CAINMSGs, CAINLNP, CAINUIF, CAINAGOM, CAINOM, VPTRUSAG, VTCAPERRS, TFREE533.

Register ANLZRTE

Register ANLZRTE (Analyze_Route Message) counts the number of *Analyze_Route* messages the switch receives from the SCP.

Register ANLZRTE release history

Register ANLZRTE was introduced in UCS07 for OM group CAINMSGR, but was initially part of OM group CAINMSGs.

Associated registers

None

Associated logs

None

Extension registers

ANLZRTE2 in OM Group CAINMGR2

Register validation

None

OM group CAINMSGR (continued)

Register CONTINUE

Register CONTINUE (Continue Message) counts the number of *Continue* messages the switch receives from the SCP.

Register CONTINUE release history

Register CONTINUE was introduced in UCS07 for OM group CAINMSGR, but was initially part of OM group CAINMSGs.

Associated registers

None

Associated logs

None

Extension registers

CONTINU2 in OM Group CAINMGR2

Register validation

None

Register DISCON

Register DISCON (Disconnect Message) counts the number of *Disconnect* messages the switch receives from the SCP.

Register DISCON release history

Register DISCON was introduced in UCS07 for OM group CAINMSGR, but was initially part of OM group CAINMSGs.

Associated registers

None

Associated logs

None

Extension registers

None

Register validation

None

Register SND2RSRC

Register SND2RSRC (Send_To_Resource Message) counts the number of *Send_To_Resource* messages the switch receives from the SCP.

OM group CAINMSGR (continued)

Register SND2RSRC release history

Register SND2RSRC was introduced in UCS07 for OM group CAINMSGR, but was initially part of OM group CAINMSGs.

Associated registers

None

Associated logs

None

Extension registers

SND2RSR2 in OM Group CAINMGR2

Register validation

None

Register FAILREPR

Register FAILREPR (Failure_Report Received) counts the number of *Failure_Report* messages the switch receives from the SCP.

Register FAILREPR release history

Register FAILREPR was introduced in UCS07 for OM group CAINMSGR, but was initially part of OM group CAINMSGs.

Associated registers

None

Associated logs

None

Extension registers

None

Register validation

None

Register REPERRR

Register REPERRR (Report_Error Received) counts the number of *Report_Error* messages the switch receives from the SCP.

Register REPERRR release history

Register REPERRR was introduced in UCS07 for OM group CAINMSGR, but was initially part of OM group CAINMSGs.

OM group CAINMSGR (continued)

Associated registers

None

Associated logs

None

Extension registers

None

Register validation

None

Register CLOSER

Register CLOSER (Close Message Received) counts the number of *Close* messages the switch receives from the SCP.

Register CLOSER release history

Register CLOSER was introduced in UCS07 for OM group CAINMSGR, but was initially part of OM group CAINMSGs.

Associated registers

None

Associated logs

None

Extension registers

None

Register validation

None

Register APPLERRR

Register APPLERRR (Application_Error Message Received) counts the number of *Application_Error* messages the switch receives from the SCP.

Register APPLERRR release history

Register APPLERRR was introduced in UCS07 for OM group CAINMSGR, but was initially part of OM group CAINMSGs.

Associated registers

None

OM group CAINMSGR (continued)

Associated logs

None

Extension registers

None

Register validation

None

Register CANCRSRC

Register CANCRSRC (Cancel_Resource_Event Message) counts the number of *Cancel_Resource_Event* messages the switch receives from the SCP.

Register CANCRSRC release history

Register CANCRSRC was introduced in UCS07 for OM group CAINMSGR, but was initially part of OM group CAINMSGs.

Associated registers

None

Associated logs

None

Extension registers

CANCRSR2 in OM Group CAINMGR2

Register RRBCMEVT

Register RRBCMEVT (Request_Report_BCM_Event Message) counts the number of *Request_Report_BCM_Event* messages the switch receives from the SCP.

Register RRBCMEVT release history

Register RRBCMEVT was introduced in UCS07.

Associated registers

None

Associated logs

None

Extension registers

RRBCMEV2 in OM Group CAINMGR2

OM group CAINMSGR (continued)

Register COLLINFO

Register COLLINFO (Collect_Information Messages) counts the number of Collect_Information messages received by the SSP.

Register COLLINFO release history

Register COLLINFO was introduced in UCS08.

Associated registers

The processing of the Collect_Information message can peg the following registers:

- QUERY, RESPRCVD, BLOCKED, IGNORE, NOTRIG, LEAVETDP, ERROR, NO_MATCH, CTRCONV, and CCLRCONV of OM group CAINTRIG.
- CTRCLR and OMIDCALL of OM group CAINMSGS.
- DISCON, CON2RSRC, APPLERRR, FAILREPR, and REPERRR of OM group CAINMSGR.
- AGQUERY, AGRESPR, AGERROR, AGCTRCNV, and AGCTRCLR of OM group CAINAGOM.

Associated logs

None

Extension registers

COLLINF2 in OM Group CAINMGR2

Register CON2RSRC

Register CON2RSRC (Connect to Resource Messages) counts the number of Connect_To_Resource messages received by the SSP.

Register CON2RSRC release history

Register CON2RSRC was introduced in UCS08.

Associated registers

The processing of the Connect_To_Resource message can peg the following registers:

- QUERY, RESPRCVD, BLOCKED, IGNORE, NOTRIG, LEAVETDP, ERROR, NO_MATCH, CTRCONV, and CCLRCONV of OM group CAINTRIG.
- CTRCLR and OMIDCALL of OM group CAINMSGS.

OM group CAINMSGR (continued)

- DISCON, COLLINFO, APPLERRR, FAILREPR, and REPERRR of OM group CAINMSGR
- AGQUERY, AGRESPR, AGERROR, AGCTRCNV, and AGCTRCLR of OM group CAINAGOM.

Associated logs

None

Extension registers

CON2RSR2 in OM Group CAINMGR2

Register CISTRSC

Register CISTRSC (Call Info to Resource Messages) counts the number of Call_Info_To_Resource messages received from the SCP.

Register CISTRSC release history

Register CISTRSC was introduced in UCS08.

Associated registers

None

Associated logs

None

Extension registers

CISTRSC2 in OM Group CAINMGR2.

Register AUTHTERM

Register AUTHTERM (Authorize Termination Messages) counts the number of Authorize_Termination messages received by the SSP.

Register AUTHTERM release history

Register AUTHTERM was introduced in UCS08.

Associated registers

The processing of the Authorize_Termination query message can peg the following registers:

- QUERY and ERROR of OM group CAINTRIG.
- TERMATT of OM group CAINMSGs.
- TQUERY, TRESPR and TERROR of OM group CAINAGOM.

OM group CAINMSGR (continued)

Associated logs

None

Extension registers

AUTHTERM2 in OM Group CAINMGR2

Register SENDNOT

Register SENDNOT (Send_Notification message) counts the number of Send_Notification messages received by the Service Switching Point (SSP).

Register SENDNOT release history

Register SENDNOT was introduced in UCS09.

Associated registers

None

Associated logs

None

Extension registers

SENDNOT2 in OM Group CAINMGR2

Register ACG

Register ACG (Automatic Code Gapping). Register ACG counts the number of ACG messages received by the Service Switching Point.

Register ACG release history

Register ACG was created in UCS09.

Associated registers

Not applicable

Associated logs

Not applicable

Extension registers

ACG2 in OM Group CAINMGR2

Register ACGRESTR

Register ACGRESTR (ACG Global Control Restore). Register ACGRESTR is used to count the number of ACG_Global_Control_Restore messages which are received by the Service Switching Point (SSP).

OM group CAINMSGR (continued)

Register ACGRESTR release history

Register ACGRESTR was created in UCS09.

Associated registers

Not applicable

Associated logs

Not applicable

Extension registers

Not applicable

Register TR533R

Register TR533R (Toll-free messages received). This OM group supports the Bellcore TR-NWT-000533 specifications for the DMS-250 switch.

Register TR533R release history

Register TR533R was added in UCS09.

Associated registers

The registers in OM group TFREE533 peg more specific behavior of the Toll-Free Services interactions.

Associated logs

Not applicable

Extension registers

TR533R2 in OM Group CAINMGR2

Register ORIGCALL

Register ORIGCALL (Originate_Call Message) counts the number of Originate_Call messages received from the SCP at the SSP.

Register ORIGCALL release history

Register ORIGCALL was introduced in UCS11.

Associated registers

None

Associated logs

Not applicable

OM group CAINMSGR (continued)

Extension registers

Not applicable

Register MERGECL

Register MERGECL (Merge_Call Message) counts the number of Merge_Call messages received from the SCP at the SSP.

Register MERGECL release history

Register MERGECL was introduced in UCS11.

Associated registers

None

Associated logs

Not applicable

Extension registers

Not applicable

Register DISCLEG

Register DISCLEG (Disconnect_Leg Message) counts the number of Disconnect_Leg messages received from the SCP at the SSP.

Register DISCLEG release history

Register DISCLEG was introduced in UCS11.

Associated registers

None

Associated logs

Not applicable

Extension registers

Not applicable

Register ACKNOW

Register ACKNOW (Acknowledge Message) counts the number of Acknowledge messages received from the SCP at the SSP.

Register ACKNOW release history

Register ACKNOW was introduced in UCS11.

OM group CAINMSGR (end)

Associated registers

None

Associated logs

Not applicable

Extension registers

Not applicable

Register FAMAINFO

Register FAMAINFO (Furnish AMA Information). Register FAMAINFO counts the total number of Furnish_AMA_Information messages the UCS DMS-250 switch receives from the SCP.

Register FAMAINFO release history

Register FAMAINFO was added in UCS14.

Associated registers

None

Associated logs

None

Extension registers

FAMAINF2 in OM group CAINMGR2

Register validation

None

OM group CAINMSGGS

OM description

The Carrier AIN Message Sent (CAINMSGGS) group provides OMs for TCAP messages sent to the Service Control Point (SCP) for CAIN processing.

Release history

Register IANOLNP was added in UCS15.

Extension OM group CAINMGS2 was added for this OM group in UCS13.

Registers OABANDON and FAILUREO were added in UCS11 (AX1372).

Register TR533S (AX1377) was added in UCS09.

Registers OMIDCALL, CTRCLR, TIMEOUTS, ODISC, CIFRSC, and, TERMATT are added in UCS08.

Registers OTERMSZ and OANSWR were introduced in UCS07.

The following registers, from OM group CAINMSGGS software release UCS06, have been moved from CAINMSGGR to OM group CAINMSGGS in software release UCS07:

- ANLZRTE
- APPLERRR
- CANCRSRC
- CLOSER
- CONTINUE
- DISCON
- FAILRESPR
- REPERRR
- SND2RSRC

The following registers were added in the UCS06 software release:

- RSRCCLR
- CANCRSRC
- ORIGATT
- INFOCOLL
- NETWBUSY

OM group CAINMSGGS (continued)

- OCLDBUSY
- O_NOANSW
- O_FTRREQ

OM group CAINMSGGS was introduced in UCS05.

Registers

The OM group CAINMSGGS registers display on the MAP terminal as follows:

ORIGATT	O_FTRREQ	INFOCOLL	INFOANLZ
NETWBUSY	OCLDBUSY	O_NOANSW	FAILREPS
REPERRS	CLOSES	APPLERRS	RSRCCLR
OTERMSZ	OANSWR	TIMEOUTS	ODISC
CIFRSC	TERMATT	OMIDCALL	CTRCLR
TR533S	OABANDON	FAILUREO	IANOLNP

Group structure

OM group CAINMSGGS consists of one tuple.

Key field:

None

Info field:

None

Associated OM groups

CAINTRIG, CAINOM, CAINAGOM, CAINMSGR, CAINAGOM, CAINUIF, CAINLNP, VPTRUSAG, VTCAPERRS, TFREE533.

Register ORIGATT

Register ORIGATT (Origination_Attempt Message) counts the number of *Origination_Attempt* messages sent to the Service Control Point (SCP).

Register ORIGATT release history

Register ORIGATT was introduced in UCS06.

Associated registers

None

OM group CAINMSGs (continued)

Associated logs

None

Extension registers

ORIGATT2 in OM Group CAINMGS2

Register validation

None

Register O_FTRREQ

Register O_FTRREQ (O_Feature_Requested Message) counts the number of *O_Feature_Requested* messages sent to the SCP.

Register O_FTRREQ release history

Register O_FTRREQ was introduced in UCS06.

Associated registers

None

Associated logs

None

Extension registers

O_FTRRE2 in OM Group CAINMGS2

Register validation

None

Register INFOCOLL

Register INFOCOLL (Info_Collected Message) counts the number of *Info_Collected* messages sent to the SCP.

Register INFOCOLL release history

Register INFOCOLL was introduced in UCS06.

Associated registers

None

Associated logs

None

Extension registers

INFOCOL2 in OM Group CAINMGS2

OM group CAINMSG (continued)

Register validation

None

Register INFOANLZ

Register INFOANLZ (Info_Analyzed Message) counts the number of *Info_Analyzed* messages sent to the SCP by the UCS DMS-250 switch.

Register INFOANLZ release history

Register INFOANLZ was introduced in UCS05.

Associated registers

None

Associated logs

None

Extension registers

INFOANL2 in OM Group CAINMGS2

Register validation

None

Register NETWBUSY

Register NETWBUSY (Network_Busy Message) counts the number of *Network_Busy* messages sent to the SCP.

Register NETWBUSY release history

Register NETWBUSY was introduced in UCS06.

Associated registers

None

Associated logs

None

Extension registers

NETWBUS2 in OM Group CAINMGS2

Register validation

None

OM group CAINMSGs (continued)

Register OCLDBUSY

Register OCLDBUSY (O_Called_Party_Busy Message) counts the number of *O_Called_Party_Busy* messages sent to the SCP.

Register OCLDBUSY release history

Register OCLDBUSY was introduced in UCS06.

Associated registers

None

Associated logs

None

Extension registers

OCLDBUS2 in OM Group CAINMGS2

Register validation

None

Register O_NOANSW

Register O_NOANSW (O_No_Answer Message) counts the number of *O_No_Answer* messages sent to the SCP.

Register O_NOANSW release history

Register O_NOANSW was introduced in UCS06.

Associated registers

None

Associated logs

None

Extension registers

O_NOANS2 in OM Group CAINMGS2

Register validation

None

Register FAILREPS

Register FAILREPS (Failure_Report Sent) counts the number of *Failure_Report* messages sent to the SCP.

OM group CAINMSGs (continued)

Register FAILREPS release history

Register FAILREPS was introduced in UCS05.

Associated registers

None

Associated logs

None

Extension registers

None

Register validation

None

Register REPERRS

Register REPERRS (Report_Error Sent) counts the number of *Report_Error* messages sent to the SCP.

Register REPERRS release history

Register REPERRS was introduced in UCS05.

Associated registers

None

Associated logs

None

Extension registers

None

Register validation

None

Register CLOSES

Register CLOSES (Close Message Sent) counts the number of *Close* messages sent to the SCP.

Register CLOSES release history

Register CLOSES was introduced in UCS05.

Associated registers

None

OM group CAINMSGs (continued)

Associated logs

None

Extension registers

None

Register validation

None

Register APPLERRS

Register APPLERRS (Application_Error Message Sent) counts the number of *Application_Error* messages sent to the SCP.

Register APPLERRS release history

Register APPLERRS was introduced in UCS05.

Associated registers

None

Associated logs

None

Extension registers

None

Register validation

None

Register RSRCCLR

Register RSRCCLR (Resource_Clear Message) counts the number of *Resource_Clear* messages sent to the SCP.

Register RSRCCLR release history

Register RSRCCLR was introduced in UCS06.

Associated registers

None

Associated logs

None

Extension registers

RSRCCLR2 in OM Group CAINMGS2

OM group CAINMSGs (continued)

Register validation

None

Register OTERMSZ

Register OTERMSZ (O_Term_Seized Message) counts the number of *O_Term_Seized* messages sent by the SSP.

Register OTERMSZ release history

Register OTERMSZ was introduced in UCS07.

Associated registers

None

Associated logs

None

Extension registers

OTERMSZ2 in OM Group CAINMGS2

Register validation

None

Register OANSWR

Register OANSWR (O_Answer Message) counts the number of *O_Answer* messages sent by the SSP.

Register OANSWR release history

Register OANSWR was introduced in UCS07.

Associated registers

None

Associated logs

None

Extension registers

OANSWR2 in OM Group CAINMGS2

Register validation

None

OM group CAINMSGs (continued)

Register OMIDCALL

Register OMIDCALL (O_Mid_Call Messages) counts the number of O_Mid_Call query messages sent by the SSP.

Register OMIDCALL release history

Register OMIDCALL was introduced in UCS08.

Associated registers

The processing of the O_Mid_Call query message can peg the following registers:

- QUERY, RESPRCVD, BLOCKED, IGNORE, NOTRIG, LEAVETDP, ERROR, NO_MATCH, CTRCONV, and CCLRCONV of OM group CAINTRIG.
- CTRCLR of OM group CAINMSGs.
- DISCON, CON2RSRC, COLLINFO, APPLERRR, FAILREPR, and REPERRR of OM group CAINMSGR.
- AGQUERY, AGRESPR, AGERROR, AGCTRCNV, and AGCTRCLR of OM group CAINAGOM.

Associated logs

None

Extension registers

OMIDCAL2 in OM Group CAINMGS2

Register CTRCLR

Register CTRCLR (CTR_Clear Messages) counts the number of CTR_Clear messages sent by the SSP.

Register CTRCLR release history

Register CTRCLR was introduced in UCS08.

Associated registers

The processing of the CTR_Clear message can peg the following registers:

- QUERY, RESPRCVD, BLOCKED, IGNORE, NOTRIG, LEAVETDP, ERROR, NO_MATCH, CTRCONV, and CCLRCONV of OM group CAINTRIG.
- OMIDCALL of OM group CAINMSGs.

OM group CAINMSGs (continued)

- DISCON, CON2RSRC, COLLINFO, APPLERRR, FAILREPR, and REPERRR of OM group CAINMSGR.
- AGQUERY, AGRESPR, AGERROR, AGCTRCNV, and AGCTRCLR of OM group CAINAGOM.

Associated logs

None

Extension registers

CTRCLR2 in OM Group CAINMGS2

Register CIFRSC

Register CIFRSC (Call Info From Resource Message) counts the number of Call_Info_From_Resource messages sent (on a per switch basis) to the SCP.

Register CIFRSC release history

Register CIFRSC was introduced in UCS08.

Associated registers

None

Associated logs

None

Extension registers

CIFRSC2 in OM Group CAINMGS2

Register TERMATT

Register TERMATT (Termination Attempt) counts the number of Termination_Attempt messages sent by the SSP.

Register TERMATT release history

Register TERMATT was introduced in UCS08.

OM group CAINMSGS (continued)

Associated registers

The processing of the Termination_Attempt query message can peg the following registers:

- QUERY, RESPRCVD, BLOCKED, IGNORE, NOTRIG, LEAVETDP, ERROR, NO_MATCH, STRCONV and RCLRCONV of OM group CAINTRIG.
- CAINMSGR registers: DISCON, SND2RSRC, APPLERRR, FAILREPR, REPERRR and AUTHTERM of OM group CAINMSGR.
- CAINAGOM registers: TQUERY, TRESPR, TERROR, TSTRCNV, TRSCLR, TVIPREQ and TVIPRSP of OM group CAINAGOM.

Associated logs

None

Extension registers

TERMATT2 in OM Group CAINMGS2

Register TIMEOUTS

Register TIMEOUTS (Timeout Messages) counts the number of Timeout Messages sent by the SSP

Register TIMEOUTS release history

Register TIMEOUTS was introduced in UCS08.

Associated registers

The processing of the Timeout message can peg the following registers:

- ERROR and EDPREQ of OM group CAINTRIG.
- AGEDPREQ and AGERROR of OM group CAINAGOM.

Associated logs

None

Extension registers

TIMEOUT2 in OM Group CAINMGS2

Register ODISC

Register ODISC (O_Disconnect Message) counts the number of O_Disconnect Messages sent by the SSP.

Register ODISC release history

Register ODISC was introduced in UCS08.

OM group CAINMSGs (continued)

Associated registers

The processing of the O_Disconnect message can peg the following registers:

- ERROR, EDPNOTIF and EDPREQ of OM group CAINTRIG.
- AGEDPNOT, AGERROR and AGEDPREQ of OM group CAINAGOM.

Associated logs

None

Extension registers

ODISC2 in OM Group CAINMGS2

Register TR533S

Register TR533S (Toll-Free Services Messages sent). This OM group supports the Bellcore TR-NWT-000533 specifications for the DMS-250 switch.

Register TR533S release history

Register TR533S was introduced in UCS09.

Associated registers

The registers in OM group TFREE533 peg more specific behavior of the Toll-Free Services interactions.

Associated logs

Not applicable

Extension registers

TR533S2 in OM Group CAINMGS2

Register OABANDON

Register OABANDON (O_Abandon Messages Sent) counts the number of O_Abandon EDP Request messages sent from the SSP to the SCP.

Register OABANDON release history

Register OABANDON was introduced in UCS11.

Associated registers

None.

Associated logs

Not applicable.

OM group CAINMSGs (continued)

Extension registers

Not applicable.

Register validation

Not applicable

Register FAILUREO

Register FAILUREO (Failure Outcome messages sent) counts the number of times a Failure_Outcome message is sent from the SSP to the SCP.

Register FAILUREO release history

Register FAILUREO was introduced in UCS11.

Associated registers

None.

Associated logs

Not applicable.

Extension registers

Not applicable.

Register validation

Not applicable

Register IANOLNP

Register IANOLNP (Info Analyzed No LNP) counts the total number of Info_Analyzed queries with Specific_Feature_Code, Customized_Dialing_Plan or Specific_Digit_String trigger sent to the SCP.

Register FAILUREO release history

Register IANOLNP was introduced in UCS15.

Associated registers

None.

Associated logs

Not applicable.

Extension registers

Not applicable.

1-414 Operational measurement groups

OM group CAINMSGS (end)

Register validation

None

OM group CAINNCRS

OM description

The OM group CAINNCRS provides reporting information for each Carrier AIN0.2 non-call related message that is sent by the switch.

Release history

OM group CAINNCRS was introduced in UCS09 (AX0976).

Registers

The following OM group CAINNCRS registers display on the MAP terminal as follows:

```
TERMNOT  ACGOVFLW  ACGRSCSS
```

Group structure

OM group CAINNCRS is one tuple.

Key field:

None

Info field:

None

Associated OM groups

CAINOM, CAINAGOM, CAINMSGR and CAINTRIG.

Register TERMNOT

Register TERMNOT (Termination_Notification messages) counts the number of Termination notification messages sent to the Service Control Point by the switch.

Register TERMNOT release history

Register TERMNOT was created in UCS09 (AX0972).

OM group CAINNCRS (end)

Associated registers

None

Associated logs

None

Extension registers

None

Register ACGOVFLW

Register ACGOVFLW (ACG Overflow). Register ACGOVFLW is used to count the number of ACG Overflow messages which are sent by the switch.

Register ACGOVFLW release history

Register ACGOVFLW was created in UCS09 (AX0976).

Associated registers

None

Associated logs

None

Extension registers

None

Register ACGRSCSS

Register ACGRSCSS (ACG Global Control Restore Success messages). Register ACGRSCSS counts the number of ACG_Global_Control_Restore_Success messages which are sent by the switch.

Register ACGRSCSS release history

Register ACGRSCSS was introduced in UCS09 (AX0976).

Associated registers

None

Associated logs

None

Extension registers

None

OM group CAINOM

OM description

The Carrier AIN OM (CAINOM) group provides threshold reporting of OMs for the Carrier Advanced Intelligent Network (CAIN).

Release history

Registers AINT1TO and AINT1ATO were updated in UCS15.

Registers AINRSVD1, AINRSVD2, AINRSVD3, and AINRSVD4 are introduced in UCS14 (A60008668). These registers are reserved for future use and do not provide any pegging capabilities at this time.

Registers LAMAFAIL, LAMAREXH, AINT1TO, and AINT1ATO are also introduced in UCS14 (A60008668).

Extension registers, AINACGB2, AINCGR2, and TERMGNC2 were added in UCS13.

Register AINACGBK and AINACGRQ (AX0976) were added in UCS09.

Registers AINTOVFL and TERMGNCT are introduced in UCS07.

Registers AINTOTQ, AINTOTR, AINTOTE, AINEANTQ, AINEANTR, AINEANTT, AINEANTE, AINDALQ, AINDALR, AINDALT, AINDALE, AINPRIQ, AINPRIR, AINPRIE, AINTOTIC, AINTOTOC, AINEANIC, AINEANOC, AINDALOC, AINPRIIC, AINPRIOC, AINIMTQ, AINIMTR, AINIMTT, and AINIMTE are deleted in software release UCS07.

Registers introduced in UCS06:

- AINTIMO
- AINTRDNA
- AINSBOUT
- AINABNDN

OM group CAINOM was introduced in UCS05.

Registers

OM group CAINOM registers display on the MAP terminal as follows:

OM group CAINOM (continued)

AINTIMO	AINTRDNA	AINSBOUT	AINBNDN
AINTOVFL	TERMGNCT	AINACGBK	AINACGRQ
TERMGNC2	AINACGB2	AINACGR2	AINRSVD1
AINRSVD2	AINRSVD3	AINRSVD4	LAMAFAIL
LAMAREXH	AIN1TO	AIN1ATO	

Group structure

OM group CAINOM consists of one tuple.

Key field:

None

Info field:

None

Associated OM groups

CAINTRIG, CAINMSGs, CAINMSGR, CAINAGOM, CAINUIF, CAINLNP, VPTRUSAG, VTCAPSNT, VTCAPERR, and VTCAPRCV

Register AINTIMO

Register AINTIMO (AIN Time Outs) counts the number of T1 timeouts that occur when the switch queries the SCP.

Register AINTIMO release history

Register AINTIMO was introduced in UCS06.

Associated registers

None

Associated logs

None

Extension registers

None

Register validation

None

OM group CAINOM (continued)

Register AINTRDNA

Register AINTRDNA (AIN Transaction Identifiers Not Available) counts the number of query attempts sent to the SCP when TCAP transaction identifiers are not available.

Register AINTRDNA release history

Register AINTRDNA was introduced in UCS06.

Associated registers

None

Associated logs

None

Extension registers

None

Register validation

None

Register AINSBOUT

Register AINSBOUT (AIN Subsystem Out-of-service) counts the number of queries attempted while the CAIN subsystem is out of order.

Register AINSBOUT release history

Register AINSBOUT was introduced in UCS06.

Associated registers

None

Associated logs

None

Extension registers

None

Register validation

None

Register AINABNDN

Register AINABNDN (AIN Caller Abandons) counts the total number of call abandons on all CAIN-capable calls.

OM group CAINOM (continued)

Register AINABNDN release history

Register AINABNDN was introduced in UCS06.

Associated registers

None

Associated logs

None

Extension registers

None

Register validation

None

Register AINTOVFL

Register AINTOVFL (AIN Timeout Overflows) counts the number of times a SCP overflow query is attempted after a T1 timeout occurs on a CAIN call.

Register AINTOVFL release history

Register AINTOVFL was introduced in UCS07.

Associated registers

None

Associated logs

None

Extension registers

None

Register validation

None

Register TERMGNCT

Register TERMGNCT (Termination General No Circuit) counts the number of calls made on a CAIN-capable agency when TERMGNCT is datafilled as the trigger criteria in table NETBUSY.

Register TERMGNCT release history

Register TERMGNCT was introduced in UCS07.

OM group CAINOM (continued)

Associated registers

None

Associated logs

None

Extension registers

TERMGNC2

Register validation

None

Register AINACGBK

Register AINACGBK (ACG Block). Register AINACGBK counts the number of CAIN queries that are blocked by ACG controls.

Register AINACGBK release history

Register AINACGBK register was added in UCS09.

Associated registers

None

Associated logs

None

Extension registers

AINACGB2

Register validation

None

Register AINACGRQ

Register AINACGRQ (ACG Requeries). Register AINACGRQ counts the number of times requeries are performed when a query is blocked by an ACG control.

Register AINACGRQ release history

Register AINACGRQ was added in UCS09.

Associated registers

None

OM group CAINOM (continued)

Associated logs

None

Extension registers

AINACGR2

Register validation

None

Register AINRSVD1

Register AINRSVD1 is reserved for future use and does not provide any pegging capability for UCS14.

Register AINRSVD1 release history

Register AINRSVD1 was added in UCS14.

Associated registers

None

Associated logs

None

Extension registers

None

Register validation

None

Register AINRSVD2

Register AINRSVD2 is reserved for future use and does not provide any pegging capability for UCS14.

Register AINRSVD2 release history

Register AINRSVD2 was added in UCS14.

Associated registers

None

Associated logs

None

Extension registers

None

OM group CAINOM (continued)

Register validation

None

Register AINRSVD3

Register AINRSVD3 is reserved for future use and does not provide any pegging capability for UCS14.

Register AINRSVD3 release history

Register AINRSVD3 was added in UCS14.

Associated registers

None

Associated logs

None

Extension registers

None

Register validation

None

Register AINRSVD4

Register AINRSVD4 is reserved for future use and does not provide any pegging capability for UCS14.

Register AINRSVD4 release history

Register AINRSVD4 was added in UCS14.

Associated registers

None

Associated logs

None

Extension registers

None

Register validation

None

OM group CAINOM (continued)

Register LAMAFAIL

Register LAMAFAIL (Lost AMA Failure). Register LAMAFAIL counts the total number of lost AMA call data due to failure.

Register LAMAFAIL release history

Register LAMAFAIL was added in UCS14.

Associated registers

None

Associated logs

None

Extension registers

None

Register validation

None

Register LAMAREXH

Register LAMAREXH (Lost AMA Resource Exhaustion). Register LAMAREXH counts the total number of lost AMA call data due to resource exhaustion.

Register LAMAREXH history

Register LAMAREXH was added in UCS14.

Associated registers

None

Associated logs

The UCS DMS-250 switch generates the CAIN100 log for any of the following conditions:

- CAIN attempts to claim a Furnish_AMA extension block and cannot.
- the switch receives a Furnish_AMA_Information message without having received an AMAslpID parameter in the call-related component that arrived first in the TCAP package.
- the switch receives a Furnish_AMA_Information message with a call-related message other than Analyze_Route or Send_to_Resource.

Extension registers

None

OM group CAINOM (continued)

Register validation

None

Register AINT1TO

Register AINT1TO(AIN T1 Timeout). Register AINT1TO counts the total number of T1 timeouts that occur when the UCS DMS-250 switch queries the SCP. This register only reflects queries with the Info_Analyzed TDP with Specific_Feature_Code, Customized_Dialing_Plan or Specific_Digit_String trigger and with the Info_Collected TDP with Offhook_Delay trigger.

Register AINT1TO release history

Register AINT1TO was added in UCS14.

Associated registers

None

Associated logs

Not applicable

Extension registers

Not applicable

Register validation

None

Register AINT1ATO

Register AINT1ATO (AIN T1 Abandon Timeout). Register AINT1ATO counts the total number of abandon calls prior to the T1 timer expiring. This register only reflects queries with the Info_Analyzed TDP with Specific_Feature_Code, Customized_Dialing_Plan or Specific_Digit_String trigger and with the Info_Collected TDP with Off_Hook_Delay trigger.

Register AINT1ATO release history

Register AINT1ATO was introduced in UCS14.

Associated registers

Not applicable

Associated logs

Not applicable

Extension registers

None

OM group CAINOM (end)

Register validation

None

OM group CAINTRI2

OM description

The Carrier AIN Trigger (CAINTRI2) group is an extension OM group of CAINTRIG. CAINTRI2 provides OMs for each Carrier Advanced Intelligent Network (CAIN) trigger and Event Detection Point.

CAINTRI2 consists of 24 tuples on each DMS switch:

- TOTAL - represents the total OM tuples pegged in this group for all of the different trigger/Event Detection Points.
- OFFHKIMM - represents OMs relating to calls that trigger at the *Off_Hook_Immediate* trigger
- OFTRREQ - represents OMs relating to calls that trigger at the *O_Feature_Requested* trigger
- OFFHKDEL - represents OMs relating to calls that encounter the *Off_Hook_Delay* trigger.
- PRIBCHNL - represents OMs relating to calls that trigger at the *PRI_B-Channel* trigger
- SIOTRK - represents OMs relating to calls that trigger at the *Shared_Interoffice_Trunk* trigger
- SPECFEAT - represents OMs relating to calls that trigger at the *Specific_Feature_Code* trigger
- CUSTDP - represents OMs relating to calls that trigger at the *Customized_Dialing_Plan* trigger
- SPECDIG - represents OMs relating to calls that trigger at the *Specific_Digit_String* trigger
- OFFCCODE - represents OMs relating to calls that trigger at the *Office_Code* trigger
- NETBUSYE - represents OMs relating to calls that encounter the *Network_Busy* event
- NETBUSY - represents OMs relating to calls that trigger at the *Network_Busy* trigger
- OTERMSZE - represents OMs relating to calls that encounter the *O_Term_Seized* event
- OCLDBSYE - represents OMs relating to calls that encounter the *O_Called_Party_Busy* event
- OCLDBUSY - represents OMs relating to calls that trigger at the *O_Called_Party_Busy* trigger

OM group CAINTRI2 (continued)

- OANSWRE - represents OMs relating to calls that encounter the *O_Answer* event
- ONOANSRE - represents OMs relating to calls that encounter the *O_No_Answer* event
- ONOANSW - represents OMs relating to calls that trigger at the *O_No_Answer* trigger
- ODISC - represents OMs relating to calls that encounter the *O_Disconnect* event
- TIMEOUT - represents OMs relating to calls that encounter the *Timeout* event
- OIECREO - represents OMs relating to calls that encounter the *O_IEC_Reorigination* trigger
- TERMATT - represents OMs relating to calls that encounter the *Termination_Attempt* trigger
- OABANDON-represents OMs relating to calls that encounter the *O_Abandon* event.
- SHF-represents OMs relating to calls that encounter the *Switch_Hook_Flash* event.

Release history

OM group CAINTRI2 was introduced in UCS13.

Registers

The OM group CAINTRI2 registers display on the MAP terminal as follows:

KEY (OM_TRIGGER_TYPE)			
QUERY2	RESRCV2	BLOCKED2	IGNORE2
NOTRIG2	LEAVETD2		NO_MATC2
STRCONV2		RCLRCON2	EDPSRCV2
EDPREQ2	EDPNOTI2	FEATADD2	FEATAUT2
FEATCAR2	NXTCNRT2		
CITR2		CIFR2	CTRCONV2
CCLRCON2			

Note: To display all registers within the same OM group requires issuing the OMSHOW command twice. For example, OMSHOW CAINTRIG active and OMSHOW CAINTRI2 active displays all registers within the group.

OM group CAINTRI2 (continued)

Group structure

OM group CAINTRI2 consists of twenty-four tuples.

Key field:

OM_TRIGGER_TYPE

Info field:

None

Associated OM groups

CAINAGOM, CAINMSGs, CAINMSGR, CAINOM, CAINUIF, CAINLNP

Register QUERY2

Register QUERY2 (Trigger Queries) is an extension register of register QUERY. QUERY2 counts the number of times a call queries the SCP.

Register QUERY2 release history

Register QUERY2 was introduced in UCS13.

Associated registers

None

Associated logs

None

Extension registers

None

Register validation

None

Register RESPRCV2

Register RESPRCV2 (Responses Received) is an extension register of register RESPRCVD. RESPRCV2 counts the number of responses the switch receives from the SCP that can be decoded and the requested action attempted. This register may be pegged when the switch receives messages Analyze_Route, Disconnect, Continue, Authorize_Termination, Collect_Information, non-conversational Connect_To_Resource and non-conversational Send_To_Resource.

Register RESPRCV2 release history

Register RESPRCV2 was introduced in UCS13.

OM group CAINTRI2 (continued)

Associated registers

None

Associated logs

None

Extension registers

None

Register validation

None

Register BLOCKED2

Register BLOCKED2 (BLOCKED2 Calls) is an extension register of register BLOCKED. BLOCKED2 counts the number of times a call has BLOCK datafilled as the trigger action in the trigger table.

Register BLOCKED2 release history

Register BLOCKED2 was introduced in UCS13.

Associated registers

None

Associated logs

None

Extension registers

None

Register validation

None

Register IGNORE2

Register IGNORE2 (IGNORE2d AIN Triggers) is an extension register of register IGNORE. IGNORE2 counts the number of times a CAIN call has IGNORE2 datafilled as the trigger action in the trigger table or encounters an Event Detection Point (EDP) with an IGNORE2 action specified in the appropriate EDP action extension parameter.

Register IGNORE2 release history

Register IGNORE2 was introduced in UCS13.

OM group CAINTRI2 (continued)

Associated registers

None

Associated logs

None

Extension registers

None

Register validation

None

Register NOTRIG2

Register NOTRIG2 (No Trigger) is an extension register of register NOTRIG. NOTRIG2 counts the number of times a CAIN call has CONT_NOTRIG2 datafilled as the trigger action in the trigger table. Call processing continues, at this current TDP (Trigger Detection Point) without checking any remaining triggers.

Register NOTRIG2 release history

Register NOTRIG2 was introduced in UCS13.

Associated registers

None

Associated logs

None

Extension registers

None

Register validation

None

Register LEAVETD2

Register LEAVETD2 (Leave Trigger Detection Point) is an extension register of register LEAVETDP. LEAVETD2 counts the number of times a CAIN call has LEAVE_TDP datafilled as the trigger action in the trigger table. Call processing continues, at this current TDP (Trigger Detection Point) without any remaining triggers.

Register LEAVETD2 release history

Register LEAVETD2 was introduced in UCS13.

OM group CAINTRI2 (continued)

Associated registers

None

Associated logs

None

Extension registers

None

Register validation

None

Register NO_MATC2

Register NO_MATC2 is an extension register of register NO_MATCH. NO_MATC2 counts the number of times a CAIN call evaluates a trigger with no match in the corresponding trigger table.

Register NO_MATC2 release history

Register NO_MATC2 was introduced in UCS13.

Associated registers

None

Associated logs

None

Extension registers

None

Register validation

None

Register STRCONV2

Register STRCONV2 (Send To Resource Conversation) is an extension register of register STRCONV. STRCONV2 counts the number of times the switch receives a Send To Resource message in a conversation package.

Register STRCONV2 release history

Register STRCONV2 was introduced in UCS13.

Associated registers

None

OM group CAINTRI2 (continued)

Associated logs

None

Extension registers

None

Register validation

None

Register RCLRCON2

Register RCLRCON2 (Resource Clear Conversation) is an extension register of register RCLRCONV. RCLRCON2 counts the number of times the switch sends a Resource Clear message in a conversation package.

Register RCLRCON2 release history

Register RCLRCON2 was introduced in UCS13.

Associated registers

None

Associated logs

None

Extension registers

None

Register validation

None

Register EDPSRCV2

Register EDPSRCV2 (Event Detection Points Received) is an extension register of register EDPSRCVD. EDPSRCV2 counts the number of times the switch receives a valid Request_Report_BCM_Event component.

Register EDPSRCV2 release history

Register EDPSRCV2 was introduced in UCS13.

Associated registers

None

Associated logs

None

OM group CAINTRI2 (continued)

Extension registers

None

Register validation

None

Register EDPREQ2

Register EDPREQ2 (Event Detection Point Requests) is an extension register of register EDPREQ. EDPREQ2 counts the number of Event Detection Point Requests the switch sends to the SCP.

Register EDPREQ2 release history

Register EDPREQ2 was introduced in UCS13.

Associated registers

None

Associated logs

None

Extension registers

None

Register validation

None

Register EDPNOTI2

Register EDPNOTI2 (Event Detection Point Notifications) is an extension register of register EDPNOTIF. EDPNOTI2 counts the number of Event Detection Point Notification messages the switch sends to the SCP.

Register EDPNOTI2 release history

Register EDPNOTI2 was introduced in UCS13.

Associated registers

None

Associated logs

None

Extension registers

None

OM group CAINTRI2 (continued)

Register validation

None

Register FEATADD2

Register FEATADD2 (Feature Address Processor) is an extension register of register FEATADDR. FEATADD2 counts the number of times a CAIN call has FEAT datafilled as the trigger action in table OFTRREQ and is datafilled with ADDR feature processor.

Register FEATADD2 release history

Register FEATADD2 was introduced in UCS13.

Associated registers

None

Associated logs

None

Extension registers

None

Register validation

None

Register FEATAUT2

Register FEATAUT2 (Feature Authorization Code Processor) is an extension register of register FEATAUTH. FEATAUT2 counts the number times a CAIN call has FEAT datafilled as the trigger action in table OFTRREQ and is datafilled with AUTH feature processor.

Register FEATAUT2 release history

Register FEATAUT2 was introduced in UCS13.

Associated registers

None

Associated logs

None

Extension registers

None

OM group CAINTRI2 (continued)

Register validation

None

Register NEXTRTE2

Register NEXTRTE (Next Route Trigger Action) is an extension register of register NEXTRTE. NEXTRTE2 counts the number of times a CAIN call has NEXTRTE datafilled as the trigger action in the trigger table or encounters an EDP with NEXTRTE action specified in the appropriate EDP action extension parameter. Tables NETBUSY, OCLDBUSY, ONOANSWR may have NEXTRTE datafilled as the trigger action in the trigger table.

Register NEXTRTE2 release history

Register NEXTRTE2 was introduced in UCS13.

Associated registers

None

Associated logs

None

Extension registers

None

Register validation

None

Register NXTCNRT2

Register NXTCNRT2 (Next Route Trigger Action) is an extension register of register NXTCNRTE. NXTCNRT2 counts the number of times a CAIN call has NXTCNRT2 datafilled as the trigger action in the trigger table or encounters an EDP with NXTCNRT2 action specified in the appropriate EDP action extension parameter. Tables NETBUSY, OCLDBUSY, ONOANSWR may have NXTCNRT2 datafilled as the trigger action in the trigger table.

Register NXTCNRT2 release history

Register NXTCNRT2 was introduced in UCS13.

Associated registers

None

Associated logs

None

OM group CAINTR12 (continued)

Extension registers

None

Register validation

None

Register CINTR2

Register CINTR2 (Call Info To Resource Messages) is an extension register of register CINTR. CINTR2 counts the number of Call_Info_To_Resource messages received by the SSP.

Register CINTR2 release history

Register CINTR2 was introduced in UCS13.

Associated registers

None

Associated logs

None

Extension registers

None

Register CIFR2

Register CIFR2 (Call Info From Resource Messages) is an extension register of register CIFR. CIFR2 counts the number Call_Info_From_Resource messages sent to the SCP.

Register CIFR2 release history

Register CIFR2 was introduced in UCS13.

Associated registers

None

Associated logs

None

Extension registers

None

OM group CAINTRI2 (continued)

Register CTRCONV2

Register CTRCONV2 (Conversational Connect_To_Resource Messages) is an extension register of register CTRCONV. CTRCONV2 counts the number of conversational Connect_To_Resource Messages received from the SCP.

Register CTRCONV2 release history

Register CTRCONV2 was introduced in UCS13.

Associated registers

The processing of the Connect_To_Resource message can peg the following registers:

- QUERY2, RESPRCV2, BLOCKED2, IGNORE2, NOTRIG2, LEAVETD2, ERROR, NO_MATC2, and CCLRCON2 of OM group CAINTRI2.
- OMIDCALL and CTRCLR of OM group CAINMSGs.
- DISCON, CON2RSRC, COLLINFO, APPLERRR, FAILREPR, and REPERRR of OM group CAINMSGR.
- AGQUERY2, AGRESPR, AGERROR, AGCTRCNV, and AGCTRCLR of OM group CAINAGOM.

Associated logs

None

Extension registers

None

Register CCLRCON2

Register CCLRCON2 (Conversational CTR_Clear Messages) is an extension register of register CCLRCONV. CCLRCON2 counts the number of CTR_Clear conversational messages sent by the SSP.

Register CCLRCON2 release history

Register CCLRCON2 was introduced in UCS13.

Associated registers

The processing of the Connect_To_Resource message can peg the following registers:

- QUERY2, RESPRCV2, BLOCKED2, IGNORE2, NOTRIG2, LEAVETD2, ERROR, NO_MATC2, and CTRCONV2 of OM group CAINTRI2.
- OMIDCALL and CTRCLR of OM group CAINMSGs.

OM group CAINTRI2 (end)

- DISCON, CON2RSRC, COLLINFO, APPLERRR, FAILREPR, and REPERRR of OM group CAINMSGR.
- AGQUERY2, AGRESPR, AGERROR, AGCTRCNV, and AGCTRCLR of OM group CAINAGOM.

Associated logs

None

Extension registers

None

OM group CAINTRIG

OM description

The Carrier AIN Trigger (CAINTRIG) group provides OMs for each Carrier Advanced Intelligent Network (CAIN) trigger and Event Detection Point.

CAINTRIG consists of 24 tuples on each DMS switch:

- TOTAL - represents the total OM tuples pegged in this group for all of the different trigger/Event Detection Points.
- OFFHKIMM - represents OMs relating to calls that trigger at the *Off_Hook_Immediate* trigger
- OFTRREQ - represents OMs relating to calls that trigger at the *O_Feature_Requested* trigger
- OFFHKDEL - represents OMs relating to calls that encounter the *Off_Hook_Delay* trigger.
- PRIBCHNL - represents OMs relating to calls that trigger at the *PRI_B-Channel* trigger
- SIOTRK - represents OMs relating to calls that trigger at the *Shared_Interoffice_Trunk* trigger
- SPECFEAT - represents OMs relating to calls that trigger at the *Specific_Feature_Code* trigger
- CUSTDP - represents OMs relating to calls that trigger at the *Customized_Dialing_Plan* trigger
- SPECDIG - represents OMs relating to calls that trigger at the *Specific_Digit_String* trigger
- OFFCCODE - represents OMs relating to calls that trigger at the *Office_Code* trigger
- NETBUSYE - represents OMs relating to calls that encounter the *Network_Busy* event
- NETBUSY - represents OMs relating to calls that trigger at the *Network_Busy* trigger
- OTERMSZE - represents OMs relating to calls that encounter the *O_Term_Seized* event
- OCLDBSYE - represents OMs relating to calls that encounter the *O_Called_Party_Busy* event
- OCLDBUSY - represents OMs relating to calls that trigger at the *O_Called_Party_Busy* trigger

- OANSWRE - represents OMs relating to calls that encounter the *O_Answer* event
- ONOANSRE - represents OMs relating to calls that encounter the *O_No_Answer* event
- ONOANSW - represents OMs relating to calls that trigger at the *O_No_Answer* trigger
- ODISC - represents OMs relating to calls that encounter the *O_Disconnect* event
- TIMEOUT - represents OMs relating to calls that encounter the *Timeout* event
- OIECREO - represents OMs relating to calls that encounter the *O_IEC_Reorigination* trigger
- TERMATT - represents OMs relating to calls that encounter the *Termination_Attempt* trigger
- OABANDON - represents OMs relating to calls that encounter the *O_Abandon* event.
- SHF - represents OMs relating to calls that encounter the *Switch_Hook_Flash* event.

Release history

Extension register QUERYSC2 added to extension group CAINTRI2 in CSP18/SN05.

Extension group CAINTRI2 was added for this OM group in UCS13.

Tuples OABANDON and SHF were added in UCS11 (AX1372).

Six new tuples are added in UCS08: OIECREO, SPECFEAT, TERMATT, TIMEOUT, ODISC, and OFFHKDEL. Six new registers are added in UCS08: CTRCONV, CCLRCONV, VIPREQ, VIPRESP, CITR, and CIFR.

12 new registers were created in UCS07: RESPRCVD, NOTRIG, LEAVETDP, STRCONV, RCLRCONV, EDPSRCVD, EDPREQ, EDPNOTIF, FEATADDR, FEATAUTH, FEATCARD and NXTCNRTE.

Changes in OM group CAINTRIG for the UCS DMS-250 switch include the following for UCS07:

- Tuple TOTAL was added.
- Registers NEXTRTE, FEAT, and RESPONSE were redefined.
- Registers RESPONSE, CONV, and FEAT were deleted

Registers CONV, NEXTRTE, and FEAT were created in UCS06.

OM group CAINTRIG was introduced in UCS05.

Registers

The following OM group CAINTRIG registers display on the MAP terminal as follows:

```

KEY (OM_TRIGGER_TYPE)
  QUERY    RESPRCVD  BLOCKED    IGNORE
  NOTRIG   LEAVETDP  ERROR      NO_MATCH
  QUERYSCU STRCONV    RCLRCONV   EDPSRCVD
  EDPREQ   EDPNOTIF   FEATADDR   FEATAUTH
  FEATCARD NEXTRTE    NXTCNRTE   VIPREQ
  VIPRESP  CITR       CIFR       CTRCONV
  CCLRCONV

```

Group structure

OM group CAINTRIG consists of twenty-four tuples.

Key field:

OM_TRIGGER_TYPE

Info field:

None

Associated OM groups

CAINAGOM, CAINMSGS, CAINMSGR, CAINOM, CAINUIF, CAINLNP

Register QUERY

Register QUERY (Trigger Queries) counts the number of times a call queries the SCP.

Register QUERY release history

Register QUERY was introduced in UCS05.

Associated registers

None

Associated logs

None

Extension registers

QUERY2 in OM Group CAINTRI2

Register validation

None

Register RESPRCVD

Register RESPRCVD (Responses Received) counts the number of responses the switch receives from the SCP that can be decoded and the requested action attempted. This register may be pegged when the switch receives messages Analyze_Route, Disconnect, Continue, Authorize_Termination, Collect_Information, non-conversational Connect_To_Resource and non-conversational Send_To_Resource.

Register RESPRCVD release history

Register RESPRCVD was introduced in UCS07.

Associated registers

None

Associated logs

None

Extension registers

RESPRCV2 in OM Group CAINTRI2

Register validation

None

Register BLOCKED

Register BLOCKED (Blocked Calls) counts the number of times a call has BLOCK datafilled as the trigger action in the trigger table.

Register BLOCKED release history

Register BLOCKED was introduced in UCS05.

Associated registers

None

Associated logs

None

Extension registers

BLOCKED2 in OM Group CAINTRI2

Register validation

None

Register IGNORE

Register IGNORE (Ignored AIN Triggers) counts the number of times a CAIN call has IGNORE datafilled as the trigger action in the trigger table or encounters an Event Detection Point (EDP) with an IGNORE action specified in the appropriate EDP action extension parameter.

Register IGNORE release history

Register IGNORE was introduced in UCS05.

Associated registers

None

Associated logs

None

Extension registers

IGNORE2 in OM Group CAINTRI2

Register validation

None

Register NOTRIG

Register NOTRIG (No Trigger) counts the number of times a CAIN call has CONT_NOTRIG datafilled as the trigger action in the trigger table. Call processing continues, at this current TDP (Trigger Detection Point) without checking any remaining triggers.

Register NOTRIG release history

Register NOTRIG was introduced in UCS07.

Associated registers

None

Associated logs

None

Extension registers

NOTRIG2 in OM Group CAINTRI2

Register validation

None

Register LEAVETDP

Register LEAVETDP (Leave Trigger Detection Point) counts the number of times a CAIN call has LEAVE_TDP datafilled as the trigger action in the

trigger table. Call processing continues, at this current TDP (Trigger Detection Point) without any remaining triggers.

Register LEAVETDP release history

Register LEAVETDP was introduced in UCS07.

Associated registers

None

Associated logs

None

Extension registers

LEAVETD2 in OM Group CAINTRI2

Register validation

None

Register ERROR

Register ERROR (Error Scenario Encountered) counts the number of times a CAIN fatal application error occurs during call processing.

Register ERROR release history

Register ERROR was introduced in UCS05.

Associated registers

None

Associated logs

None

Extension registers

None

Register validation

None

Register NO_MATCH

Register NO_MATCH counts the number of times a CAIN call evaluates a trigger with no match in the corresponding trigger table.

Register NO_MATCH release history

Register NO_MATCH was introduced in UCS05.

Associated registers

None

Associated logs

None

Extension registers

NO_MATC2 in OM Group CAINTRI2

Register validation

None

Register QUERYSCU

Register QUERYSCU (Query Service Control Unit) counts the number of times a CAIN call queries the SCU.

Register QUERYSCU release history

Register QUERYSCU was introduced in UCS06.

Associated registers

None

Associated logs

None

Extension registers

QUERYSC2 in OM group CAINTRI2

Register validation

None

Register STRCONV

Register STRCONV (Send To Resource Conversation) counts the number of times the switch receives a Send To Resource message in a conversation package.

Register STRCONV release history

Register STRCONV was introduced in UCS07.

Associated registers

None

Associated logs

None

Extension registers

STRCONV2 in OM Group CAINTRI2

Register validation

None

Register RCLRCONV

Register RCLRCONV (Resource Clear Conversation) counts the number of times the switch sends a Resource Clear message in a conversation package.

Register RCLRCONV release history

Register RCLRCONV was introduced in UCS07.

Associated registers

None

Associated logs

None

Extension registers

RCLRCON2 in OM Group CAINTRI2

Register validation

None

Register EDPSRCVD

Register EDPSRCVD (Event Detection Points Received) counts the number of times the switch receives a valid Request_Report_BCM_Event component.

Register EDPSRCVD release history

Register EDPSRCVD was introduced in UCS07.

Associated registers

None

Associated logs

None

Extension registers

EDPSRCV2 in OM Group CAINTRI2

Register validation

None

Register EDPREQ

Register EDPREQ (Event Detection Point Requests) counts the number of Event Detection Point Requests the switch sends to the SCP.

Register EDPREQ release history

Register EDPREQ was introduced in UCS07.

Associated registers

None

Associated logs

None

Extension registers

EDPREQ2 in OM Group CAINTRI2

Register validation

None

Register EDPNOTIF

Register EDPNOTIF (Event Detection Point Notifications) counts the number of Event Detection Point Notification messages the switch sends to the SCP.

Register EDPNOTIF release history

Register EDPNOTIF was introduced in UCS07.

Associated registers

None

Associated logs

None

Extension registers

EDPNOTI2 in OM Group CAINTRI2

Register validation

None

Register FEATADDR

Register FEATADDR (Feature Address Processor) counts the number of times a CAIN call has FEAT datafilled as the trigger action in table OFTRREQ and is datafilled with ADDR feature processor.

Register FEATADDR release history

Register FEATADDR was introduced in UCS07.

Associated registers

None

Associated logs

None

Extension registers

FEATADD2 in OM Group CAINTRI2

Register validation

None

Register FEATAUTH

Register FEATAUTH (Feature Authorization Code Processor) counts the number times a CAIN call has FEAT datafilled as the trigger action in table OFTRREQ and is datafilled with AUTH feature processor.

Register FEATAUTH release history

Register FEATAUTH was introduced in UCS07.

Associated registers

None

Associated logs

None

Extension registers

FEAUT2 in OM Group CAINTRI2

Register validation

None

Register FEATCARD

Register FEATCARD (Feature Card Trigger) counts the number times a CAIN call has FEAT datafilled as the trigger action in table OFTRREQ and is datafilled with CARD feature processor.

Register FEATCARD release history

Register FEATCARD was introduced in UCS07.

Associated registers

None

Associated logs

None

Extension registers

FEATCAR2 in OM Group CAINTRI2

Register validation

None

Register NEXTRTE

Register NEXTRTE (Next Route Trigger Action) counts the number of times a CAIN call has NEXTRTE datafilled as the trigger action in the trigger table or encounters an EDP with NEXTRTE action specified in the appropriate EDP action extension parameter. Tables NETBUSY, OCLDBUSY, ONOANSWR may have NEXTRTE datafilled as the trigger action in the trigger table.

Register NEXTRTE release history

Register NEXTRTE was introduced in UCS06.

Associated registers

None

Associated logs

None

Extension registers

NEXTRTE2 in OM Group CAINTRI2

Register validation

None

Register NEXTCNRTE

Register NEXTCNRTE (Next CAIN Route) counts the number of times a CAIN call has NEXTCNRTE datafilled as the trigger action or encounters an EDP with NEXTCNRTE action specified in the appropriate EDP action extension parameter. Tables NETBUSY, OCLDBUSY, and ONOANSWR may have NEXTCNRTE datafilled as the trigger action in trigger tables.

Register NEXTCNRTE release history

Register NEXTCNRTE was introduced in UCS07.

Associated registers

None

Associated logs

None

Extension registers

NEXTCNRT2 in OM Group CAINTRI2

Register validation

None

Register VIPREQ

Register VIPREQ (Virtual IP Request) counts the number of SCP requests for VIP handling through Send_To_Resource or Connect_To_Resource messages.

Register VIPREQ release history

Register VIPREQ was introduced in UCS08.

Associated registers

The processing of the Virtual IP Request can peg the following registers:

- QUERY, RESPRCVD, STRCONV, RCLRCONV, CCLRCONV and CTRCONV of OM group CAINTRIG.
- RSRCCLR of OM group CAINMSGs.
- SND2RSRC of OM group CAINMSGR.
- AGQUERY, AGRESPR, AGSTRCNV, AGRSCLR, AGCTRCNV, and AGCTRCLR of OM group CAINAGOM.

Associated logs

None

Extension registers

None

Register VIPRESP

Register VIPRESP (Virtual IP Response) counts the number of responses to an SCP with a normal ClearCause after VIP handling.

Register VIPRESP release history

Register VIPRESP was introduced in UCS08.

Associated registers

The processing of the Virtual IP Response can peg the following registers:

- QUERY, RESPRCVD, STRCONV, RCLRCONV, CCLRCONV and CTRCONV of OM group CAINTRIG.
- RSRCCLR of OM group CAINMSGs.
- SND2RSRC of OM group CAINMSGR.
- AGQUERY, AGRESPR, AGSTRCONV, AGRSCLR, AGTRCONV, and AGTRCLR of OM group CAINAGOM.

Associated logs

None

Extension registers

None

Register CTR

Register CTR (Call Info To Resource Messages) counts the number of Call_Info_To_Resource messages received by the SSP.

Register CTR release history

Register CTR was introduced in UCS08.

Associated registers

None

Associated logs

None

Extension registers

CITR2 in OM Group CAINTRI2

Register CIFR

Register CIFR (Call Info From Resource Messages) counts the number of Call_Info_From_Resource messages sent to the SCP.

Register CIFR release history

Register CIFR was introduced in UCS08.

Associated registers

None

Associated logs

None

Extension registers

CIFR2 in OM Group CAINTRI2

Register CTRCONV

Register CTRCONV (Conversational Connect_To_Resource Messages) counts the number of Conversational Connect_To_Resource Messages received from the SCP.

Register CTRCONV release history

Register CTRCONV was introduced in UCS08.

Associated registers

The processing of the Connect_To_Resource message can peg the following registers:

- QUERY, RESPRCVD, BLOCKED, IGNORE, NOTRIG, LEAVETDP, ERROR, NO_MATCH, and CCLRCONV of OM group CAINTRIG.
- OMIDCALL and CTRCLR of OM group CAINMSGGS.
- DISCON, CON2RSRC, COLLINFO, APPLERRR, FAILREPR, and REPERRR of OM group CAINMSGR.
- AGQUERY, AGRESPR, AGERROR, AGCTRCNV, and AGCTRCLR of OM group CAINAGOM.

Associated logs

None

Extension registers

None

Register CCLRCONV

Register CCLRCONV (Conversational CTR_Clear Messages) counts the number of CTR_Clear conversational messages sent by the SSP

Register CCLRCONV release history

Register CCLRCONV was introduced in UCS08.

Associated registers

The processing of the Connect_To_Resource message can peg the following registers:

- QUERY, RESPRCVD, BLOCKED, IGNORE, NOTRIG, LEAVETDP, ERROR, NO_MATCH, and CTRCONV of OM group CAINTRIG.
- OMIDCALL and CTRCLR of OM group CAINMSGGS.

- DISCON, CON2RSRC, COLLINFO, APPLERRR, FAILREPR, and REPERRR of OM group CAINMSGR.
- AGQUERY, AGRESPR, AGERROR, AGCTRCNV, and AGCTRCLR of OM group CAINAGOM.

Associated logs

None

Extension registers

CCLRCON2 in OM Group CAINTRI2

OM group CAINUIF

OM description

The Carrier AIN User Interface Framework (CAINUIF) group provides OMs for TCAP *Send_To_Resource* and *Connect_To_Resource* messages.

Release history

OM group CAINUIF is introduced in UCS06.

Registers

The following OM group CAINUIF registers display on the MAP terminal as follows:

AINTOTDC	AINTOTAN	AINUSRAB	AINRSCNA
AINRSCNI	AINTOTTN	AINBUFFR	AINBUFOV
AINPSIGN	AINPDIAL		

Group structure

OM group CAINUIF consists of one tuple.

Key field:

None

Info field:

None

Associated OM groups

None

Register AINTOTDC

Register AINTOTDC (Total Digit Collection Attempts) counts the total number of digit collection attempts by the UIF.

Register AINTOTDC release history

Register AINTOTDC is introduced in UCS06.

Associated registers

None

OM group CAINUIF (continued)

Associated logs

None

Extension registers

None

Register validation

None

Register AINTOTAN

Register AINTOTAN (Total Announcement Attempts) counts the total number of attempts to play an announcement by the UIF.

Register AINTOTAN release history

Register AINTOTAN is introduced in UCS06.

Associated registers

None

Associated logs

None

Extension registers

None

Register validation

None

Register AINUSRAB

Register AINUSRAB (AIN User Abandons) counts the total number of user abandons during use of the UIF.

Register AINUSRAB release history

Register AINUSRAB is introduced in UCS06.

Associated registers

None

Associated logs

None

Extension registers

None

OM group CAINUIF (continued)

Register validation

None

Register AINRSCNA

Register AINRSCNA (Resource Unavailable) counts the number of times resources were determined to be unavailable by the UIF.

Register AINRSCNA release history

Register AINRSCNA is introduced in UCS06.

Associated registers

None

Associated logs

None

Extension registers

None

Register validation

None

Register AINRSCNI

Register AINRSCNI (Resource Not Implemented) counts the number of times resources were determined to be not implemented or installed by the UIF.

Register AINRSCNI release history

Register AINRSCNI is introduced in UCS06.

Associated registers

None

Associated logs

None

Extension registers

None

Register validation

None

OM group CAINUIF (continued)

Register AINTOTTN

Register AINTOTTN (AIN Total Attempts to Play a Tone) counts the total number of attempts to play a tone by the UIF.

Register AINRTOTTN release history

Register AINTOTTN is introduced in UCS06.

Associated registers

None

Associated logs

None

Extension registers

None

Register validation

None

Register AINBUFFR

Register AINBUFFR (AIN Buffering Attempts) counts the number of buffering attempts by the UIF.

Register AINRBUFFR release history

Register AINBUFFR is introduced in UCS06.

Associated registers

None

Associated logs

None

Extension registers

None

Register validation

None

Register AINBUFOV

Register AINBUFOV (AIN Buffer Overflow) counts the number of buffer overflow events by the UIF.

OM group CAINUIF (continued)

Register AINBUFOV release history

Register AINBUFOV is introduced in UCS06.

Associated registers

None

Associated logs

None

Extension registers

None

Register validation

None

Register AINPSIGN

Register AINPSIGN (AIN Permanent Signal Received) counts the number of times permanent signal was received by the UIF.

Register AINPSIGN release history

Register AINPSIGN is introduced in UCS06.

Associated registers

None

Associated logs

None

Extension registers

None

Register validation

None

Register AINPDIAL

Register AINPDIAL (AIN Partial Dial Received) counts the number of times partial dial was received by the UIF.

Register AINPDIAL release history

Register AINPDIAL is introduced in UCS06.

Associated registers

None

OM group CAINUIF (end)

Associated logs

None

Extension registers

None

Register validation

None

OM group CBK

OM description

Code block group (CBK)

The OM group CBK counts call attempts that are blocked or passed by the network management (NWM) CBK control. The group counts each call attempt made under NWM CBK.

Code controls allow the operating company to:

- limit traffic that enters the network from specified destination codes
- flag codes that are hard to reach
- study the level of traffic that is routed to specified destination codes.

The OM group CBK contains two peg registers: CBKCNT, and CBKPASS.

Release history

BCS20

The OM group CBK was introduced prior to BCS20.

BCS23

The CBKPASS was added in BCS23.

Registers

The OM group CBK registers appear on the MAP terminal as follows:



CBKCNT CBKPASS

Group structure

The OM group CBK provides one tuple for each active CBK control. The maximum number of active NWM controls is 256. In offices with the NTX455AB package, the maximum number of active NWM controls is 64.

Key field:

There is no key field.

Info field:

CBK_OMINFO has the following parts: CBKKEY, CBKANN, CBK_TYPE and CBKGAP_OR_PCT_LEVEL.

The CBKKEY has the following parts: CT, DR, and SNPA.

OM group CBK (continued)

CT is the code type. The fixed CT for CBK are:

CCODE

Country code

NAC

Non-area code

ACODE

Area code

PFX

Prefix digits

The digit register (DR) is the called number code that calls are diverted from if the call comes from a specified serving numbering plan area (SNPA).

The SNPA or serving translation scheme (STS) is the area code of the serving office to which the control applies. If the control applies to all SNPA/STS served by the office, set the SNPA to ALL. If the code type is CCODE or PFX, the SNPA field does not apply. A field appears in the printout.

The CBKANN identifies the announcement to which blocked calls are to be routed. The fixed CBKANN for CBK are:

NCA

No-circuit announcement

EA1

Emergency announcement 1

EA2

Emergency announcement 2.

Calls are normally routed to the NCA. When an extreme congestion condition occurs, the blocked calls can be routed to EA1 or EA2.

The CBK_TYPE is the type of CBK control used. The fixed CBK_TYPE for CBK are:

PCT

Percentage

GAP

Call Gapping.

If the CBK_TYPE is GAP, CBKGAP_OR_PCT_LEVEL indicates the length of time between the calls that are complete. If CBK_TYPE is PCT, CBKGAP_OR_PCT_LEVEL indicates the percentage of calls to be blocked.

OM group CBK (continued)

Associated OM groups

There are no associated OM registers.

Associated functional groups

There are no associated functional groups.

Associated functionality codes

The functionality codes associated with OM group CBK appear in the following table:

Functionality	Code
NWM	NTX060AB
Local Features II	NTX902AA

OM group CBK (continued)

OM group CBK registers: originating traffic

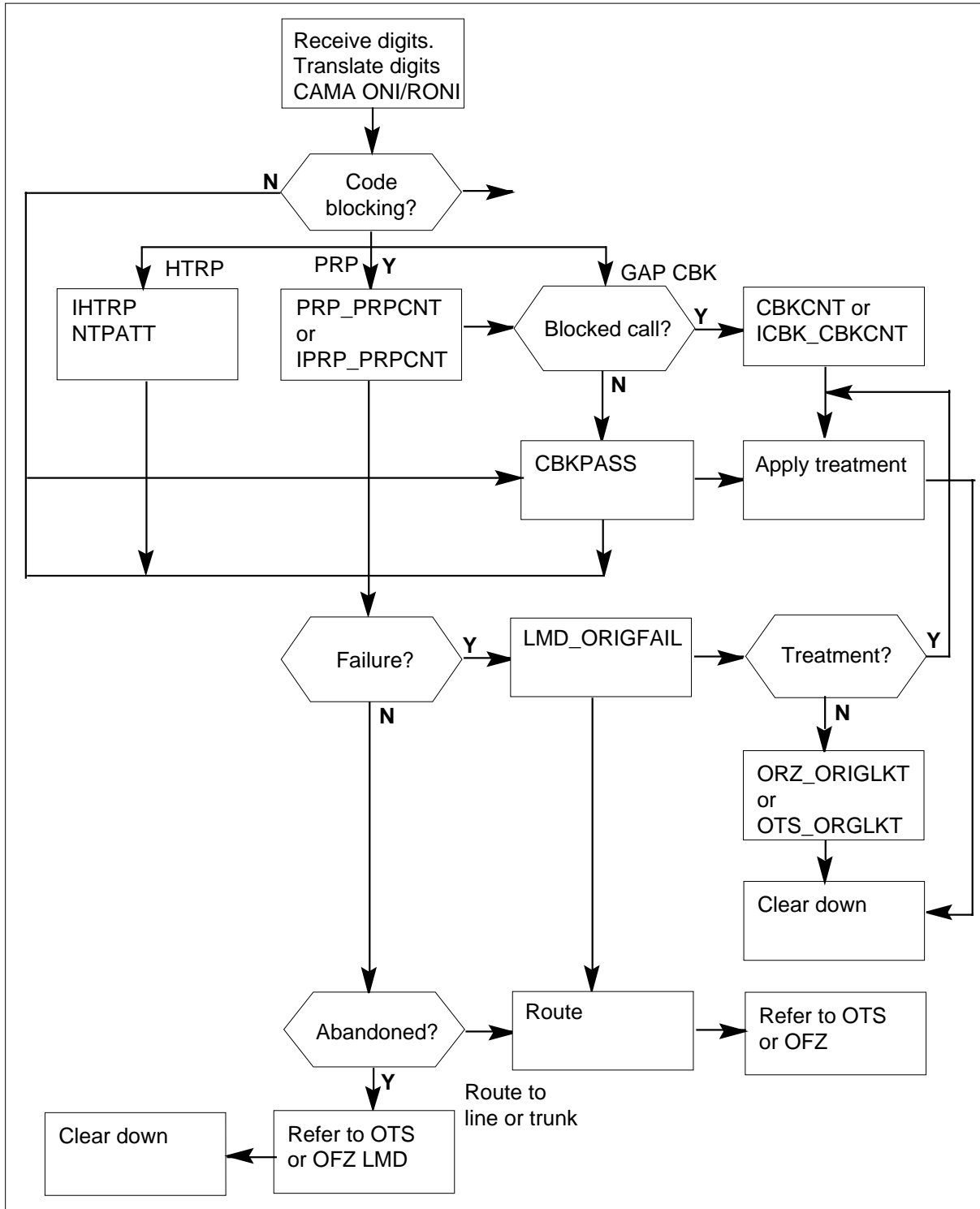

OM group CBK (continued)

OM group CBK registers: incoming traffic

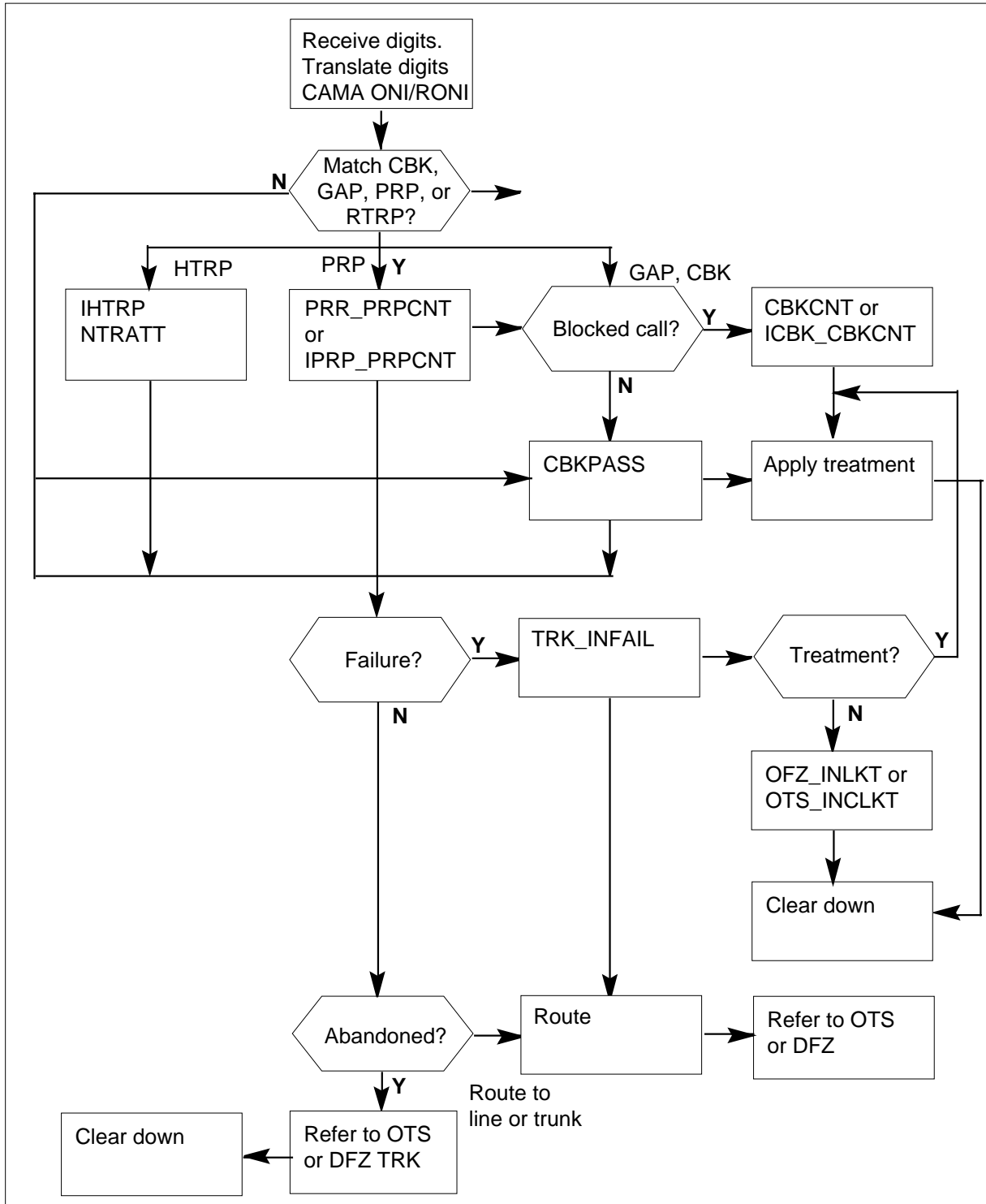

OM group CBK (continued)

CBKCNT

Code block group count (CBKCNT)

The CBKCNT counts calls that are blocked by the NWM CBK control.

CBKCNT release history

BCS20

The CBKCNT was introduced in BCS20.

Associated registers

There are no associated registers.

Associated logs

The system generates the NWM200 log when the code blocking control PCT is activated or deactivated.

Extension registers

There are no extension registers.

The system generates the NWM203 log when the code blocking control GAP is activated or deactivated.

CBKPASS

Code block group pass (CBKPASS)

The CBKPASS counts calls that are passed by the NWM CBK.

CBKPASS release history

BCS23

The CBKPASS was introduced in BCS23.

Associated registers

There are no associated registers.

Associated logs

The system generates the NWM110 log when the CBK control PCT is activated or deactivated.

OM group CBK (end)

The system generates the NWM113 log when the CBK control GAP is activated or deactivated.

Extension registers

There are no extension registers.

OM group CDR250

OM description

The OM group CDR250 serves to provide registers for monitoring the status and use of resources during call detail recording operation in a DMS switch. A new register CDRFREE is pegged for calls requiring a CDR but completing without a CDR that is free calls.

Release history

OM group CDR250 was introduced in UCS11 (AX1360). Register CDRFREE (AX1360) was added in UCS11.

Registers

The following OM group CDR250 registers display on the MAP terminal as follows:

```
cdrfree  cdrfree2
```

Group structure

OM group CDR250 has one tuple per DMS switch.

Key field:

None

Info field:

None

Associated OM groups

None

Register CDRFREE

Register CDRFREE is needed for each call needing a CDR but completing without one for the following reason:

- the recording unit (RU) extension block is unavailable and the table OFCVAR office parameter CDR_UNAVAIL_BLOCK equals "No."

Register CDRFREE is pegged when a dead process is encountered.

OM group CDR250 (end)

Register CDRFREE release history

Register CDRFREE was introduced in UCS11.

Associated registers

None

Associated logs

None

Extension registers

CDRFREE2 is the extension register for CDRFREE.

Register validation

None

OM group CF3P

OM description

Three-port conference circuits (CF3P)

Lines that use the Three-way Calling (3WC) feature request three-port conference circuits. Calls that go to service analysis positions after the activation of the position request three-port conference circuits. Trunk test positions request three-port conference circuits when a request to monitor talking is issued.

The registers in CF3P provide information on the use of a three-port conference circuit. The information includes the number of times the system seized a circuit. The information also includes the number of times that a circuit was not available. The information also includes the queue overflows and abandons.

Multiple usage registers monitor conference circuits in different busy states. Registers also monitor three-port conference circuits assigned to TOPS positions.

The USNBD feature uses the registers in OM group CF3P to monitor the usage of 3-way conference bridges used for combined CCRs.

Release history

The OM group CF3P was introduced before BCS20.

NA011

Supports use of this OM group by the USNBD feature.

APC005

Functionality is added to support Meridian Digital Centrex (MDC) features, like as 3WC, on Global Peripheral Platform (GPP) lines for the following groups.

- Australian telephone user part (ATUP)
- ANSI ISDN user part (ANSI ISUP)
- Australian ISUP (AISUP) trunk signaling

BCS33

The system can convert registers CNFTRU, CNFSBU and CNFMBU from hundred call seconds (CCS) to deci-erlangs. The system uses the command OMSHOW on the ACTIVE class to convert the register before they appear.

OM group CF3P (continued)**BCS21**

Registers CNFTRU, CNFSBU, and CNFMBU are modified. The method of calculating erlangs changes to provide average traffic values over a given time period.

BCS20

Registers CNFTRU, CNFSBU, and CNFMBU are modified. The output can be specified to be in deci-erlangs or CCS.

Registers

The OM group CF3P registers appear on the MAP terminal as follows:

CNFSZRS	CNFOVFL	CNFQOCC	CNFQOVFL
CNFQABAN	CNFTRU	CNFSBU	CNFMBU

The second variant applies to TOPS offices with toll and combined local/toll. This OM group has eleven registers:

CNFSZRST	CNFOVFLT	CNFQOCCT	CNFQOVFT
CNFQABNT	CNFTRUT	CNFSBUT	CNFMBUT
TOPSZRS	TOPSOVFL	TOPSTRU	

Group structure

The OM group CF3P provides one tuple for each office.

Info field:

CONF_MEM_NUMBER This field indicates the number of software-equipped conference circuits in the office.

Key field:

COMMON_LANGUAGE_NAME. This field contains the external identifier CF3P.

The OM group CF3P is available for non-TOPS environments and for TOPS offices with toll or combined local/toll capabilities. To obtain the correct OM outputs for TOPS offices with toll, you must set office parameter OFFICETYPE in table OFCSTD to OFF200TOPS. For combined local/toll with TOPS offices, you must set office parameter OFFICETYPE in table

OM group CF3P (continued)

OFCSTD to OFF200TOPS, OFFCOMBTOPS, OFFEADAS, OFFCOMBITOPS or OFF500.

To detect the three-port conference use in a remote office, you must set the office parameter. You must set the office parameter OFFICETYPE in table OFCSTD to OFF200TOPS or OFFCOMBTOPS.

An office that uses three-port conference circuits to serve TOPS positions uses office parameter TOPS_THRESHOLD. Office parameter TOPS_THRESHOLD in table OFCENG gives the percentage of in-service three-port circuits reserved for TOPS use. The system translates this percentage into a number of circuits each time an audit of conference circuit data occurs. The office parameter AUDIT_INTERVAL in table OFCSTD defines the audit frequency.

Associated OM groups

There are no associated OM groups.

Associated functional groups

The functional group TOPS is associated with OM group CF3P.

Associated functionality codes

The associated functionality codes for OM group CF3P appear in the following table.

Functionality	Code
Common Basic	NTX001AA

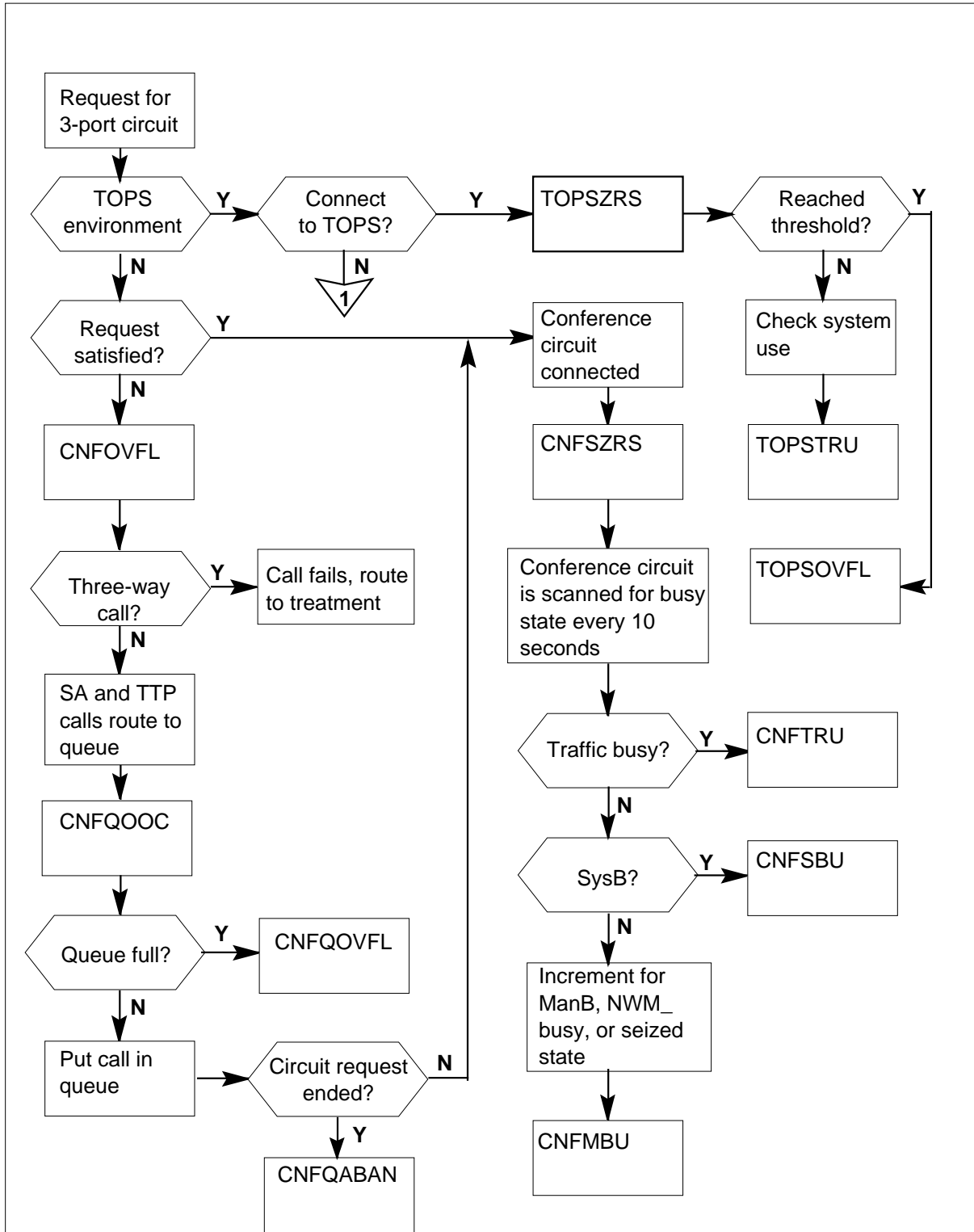
OM group CF3P (continued)**OM group CF3P registers**

OM group CF3P (continued)

OM group CF3P registers (continued)

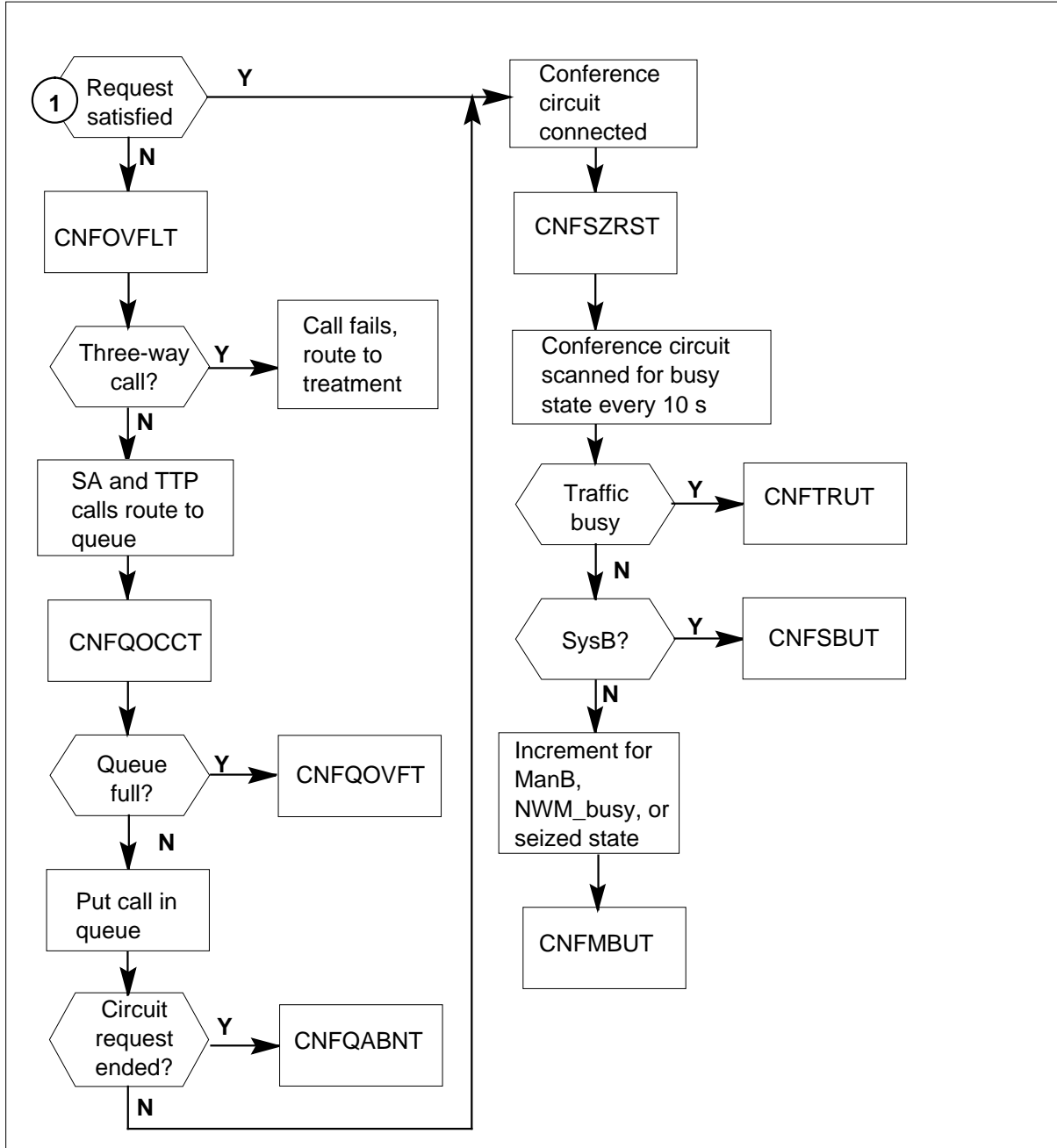

Register CNFMBU

CF3P manual busy usage (CNFMBU)

OM group CF3P (continued)

Register CNFMBU is a usage register. Every 10 s CNFMBU scans the conference circuits. CNFMBU records the number of conference circuits that are in any of the following states during the last OM transfer period:

- manual busy
- seized
- network management procedures

Maintenance personnel can seize a circuit for diagnostic tests while working from the trunk test position at the MAP terminal. Personnel also can be working by the automatic trunk test (ATT) system can seize a circuit for diagnostic tests. A system audit on the conference ports can also seize a circuit for diagnostic tests.

The system updates the active register every 10 s with the number of CF3Ps that are in any of the previously listed states. For example, if one conference port is manual busy, the active register increases by 1 every 10s. The register will continue to increase for as long as the port is in this state. The register also increases if the system seizes one of the ports for a system audit. The system copies the accumulated count to the holding register (CNFMBU) every 30 min (and erases the previous value). If no ports are in these busy states, CNFMBU will show a value that is not zero. Values that are not zero will only appear if the system counted a port during the last OM transfer period (30 min).

Non-TOPS environments use this register.

Register CNFMBU release history

Register CNFMBU was introduced before BCS20.

BCS33

When you set office parameter OMINERLANGS to Y, the usage count converts from CCS to deci-erlangs. The system uses the OMSHOW command on the ACTIVE class to convert usage counts before they appear. The value held in the active register does not change and remains in CCS.

BCS20

Register modified to allow the system to record the usage count in deci-erlangs rather than CCS.

Associated registers

There are no associated registers.

Associated logs

There are no associated logs.

OM group CF3P (continued)

Register CNFMBUT

Register CF3P manual busy usage TOPS environment (CNFMBUT)

Register CNFMBUT is a usage register. Every 10 s CNFMBUT scans the conference circuits. CNFMBUT records the number of conference circuits that are in any of the following states during the last OM transfer period:

- manual busy
- seized
- network management procedures

Maintenance personnel that work from the trunk test position at the MAP terminal can seize a circuit for diagnostic tests. The ATT system can also seize a circuit for diagnostic tests.

The system updates the active register every 10 s with the number of CF3Ps that are in any of the previously listed states. For example, if one conference port is manual busy, the active register increases by 1 every 10 s. The register will continue to increase for as long as the port is in this state. The system copies the accumulated count to the holding register (CNFMBUT) every 30 min, (and erases the previous value). CNFMBUT shows a value that is not zero if the system counted any port during the last OM transfer period of 30 min. CNFMBUT shows a value that is not zero while the ports are not in these busy states.

Register CNFMBUT release history

Register CNFMBUT was introduced before BCS20.

BCS20

Register modified to allow the system to record the usage count in deci-erlangs or CCS.

Associated registers

There are no associated registers.

Associated logs

There are no associated logs.

Register CNFOVFL

CF3P overflows (CNFOVFL)

OM group CF3P (continued)

Register CNFOVFL increases when the system can not satisfy a request for a three-port conference circuit immediately because conference circuits are busy.

Three way callig attempts fail and the system routes the calls to treatment. Service analysis and trunk test position requests attempt to queue.

The register applies to non-TOPS environments.

Register CNFOVFL release history

Register CNFOVFL was introduced before BCS20.

Associated registers

Register CNFOVFL equals the number of calls that attempt to enter the conference circuit work queue.

Number of calls that enter the queue = CNFOVFL - CNQOVFL.

Associated logs

The all trunks busy (ATB) subsystem generates ATB100 for each blocked attempt to seize a trunk to a exact numbering plan area (NPA) or central office. The system advanced the call to another route.

Register CNFOVFLT

CF3P overflows TOPS environment (CNFOVFLT)

Register CNFOVFLT counts requests for three-port conference circuits in a TOPS environment that the system can not satisfy immediately. The system can not satisfy the requests because all conference circuits are busy.

Three-way Calling attempts fail and the system routes the calls to a treatment. Service analysis and trunk test position requests attempt to queue.

Register CNFOVFLT release history

Register CNFOVFLT was introduced before BCS20.

Associated registers

Register CNFOVFLT equals the number of calls that attempt to enter the conference circuit work queue.

Number of calls that enter the queue = CNFOVFLT - CNQOVFL.

OM group CF3P (continued)

Associated logs

The ATB subsystem generates ATB100 for each blocked attempt to seize a trunk to a specified NPA or central office. The system advances the call to another route.

Register CNFQABAN

Register CF3P queue abandons (CNFQABAN)

Register CNFQABAN counts circuit requests abandoned while the requests wait in the conference circuit queue.

The system uses this register in non-TOPS environments.

Register CNFQABAN release history

Register CNFQABAN was introduced before BCS20.

Associated registers

There are no associated registers.

Associated logs

The line maintenance subsystem generates the following logs when the system encounters problems during call processing: LINE104, LINE105, LINE109, and LINE204.

Register CNFQABNT

Register CF3P queue abandons TOPS environment

Register CNFQABNT counts circuit requests abandoned while the requests wait in the conference circuit queue.

Register CNFQABNT release history

Register CNFQABNT was introduced before BCS20.

Associated registers

There are no associated registers.

Associated logs

The line maintenance subsystem when the system generates the following logs when the system encounters problems during call processing:

- LINE104
- LINE105

OM group CF3P (continued)

- LINE109
- LINE204

Register CNFQOCC

CF3P queue occupancy (CNFQOCC)

Register CNFQOCC is a usage register. Every 10 s the system scans conference circuits, and CNFQOCC records. The system scans if requests for a conference circuit are waiting in the queue. The queue consists of waiting service analysis and trunk test position requests only.

The system uses this register in non-TOPS environments.

Register CNFQOCC release history

Register CNFQOCC was introduced before BCS20.

Associated registers

There are no associated registers.

Associated logs

There are no associated logs.

Register CNFQOCCT

CF3P queue occupancy TOPS environment

Register CNFQOCCT is a usage register. Every 10 s the system scans the conference circuits, and CNFQOCCT records. The system scans if requests for a conference circuit are waiting in the queue. The queue consists of waiting service analysis and trunk test position only.

Register CNFQOCCT release history

Register CNFQOCCT was introduced before BCS20.

Associated registers

There are no associated registers.

Associated logs

There are no associated logs.

Register CNFQOVFL

CF3P queue overflows (CNFQOVFL)

OM group CF3P (continued)

Register CNFQOVFL counts attempts to enter the wait queue when the queue is full. Only requests from trunk test or service analysis positions increase this register. Other requests do not attempt to wait.

The system uses this register in non-TOPS environments.

Register CNFQOVFL release history

Register CNFQOVFL was introduced before BCS20.

Associated registers

There are no associated registers.

Associated logs

The line maintenance subsystem generates LINE 138 when the system routes a call to a treatment after being call processing busy.

The trunk maintenance subsystem generates LINE 138 when the system routes a call to a treatment after being call processing busy.

Register CNFQOVFT

CF3P queue overflows TOPS environment (CNFQOVFT)

Register CNFQOVFT counts attempts to enter the wait queue when the queue is full. Only requests from trunk test or service analysis positions increment this register, since other requests do not attempt to wait.

Register CNFQOVFT release history

Register CNFQOVFT was introduced before BCS20.

Associated registers

There are no associated registers.

Associated logs

The line maintenance subsystem generates LINE 138 when the system routes a call to a treatment after being call processing busy.

The trunk maintenance subsystem generates TRK 138 when the system routes a call to a treatment after being call processing busy.

Register CNFSBU

CF3P system busy usage (CNFSBU)

OM group CF3P (continued)

Register CNFSBU is a usage register. Every 10 s the system scans conference circuits. CNFSBU records if the conference circuits are remote busy, peripheral module busy, system busy, carrier failed, or unloaded. A conference request that originated in the system can place the conference circuits in these states.

The system uses this register in non-TOPS environments.

Register CNFSBU release history

Register CNFSBU was introduced before BCS20.

BCS33

When you set office parameter OMINERLANGS to Y, you convert the usage count from CCS to deci-erlangs before the count appears. Use the OMSHOW command on the ACTIVE class to display the usage count. The value in the active registers remains in CCS.

BCS20

Register modified to allow the system to record the usage count in deci-erlangs or CCS.

Associated registers

There are no associated registers.

Associated logs

The trunk maintenance subsystem generates TRK106 when a diagnostics test on trunk equipment fails.

Register CNFSBUT

CF3P system busy usage TOPS environment (CNFSBUT)

Register CNFSBUT is a usage register. Every 10 s the system scans the conference circuits, and CNFSBUT records. The system scans if they are remote busy, peripheral module busy, system busy, carrier failed, or unloaded. A conference request that originated in the system can place these circuits in this state.

Register CNFSBUT release history

Register CNFSBUT was introduced before BCS20.

BCS20

Register modified to allow the system to record the usage count in deci-erlangs or CCS.

OM group CF3P (continued)

Associated registers

There are no associated registers.

Associated logs

The trunk maintenance subsystem generates TRK 106 when a diagnostics test on trunk equipment fails.

Register CNFSZRS

CF3P seizures (CNFSZRS)

Register CNFSZRS increases when the system assigns a circuit in response to a request. The system assigns the circuit before an attempt to set up network paths to the three ports.

The system uses this register in non-TOPS environments.

Register CNFSZRS release history

Register CNFSZRS was introduced before BCS20.

Associated registers

There are no associated registers.

Associated logs

There are no associated logs.

Register CNFSZRST

CF3P seizures TOPS environment (CNFSZRST)

Register CNFSZRST increases when the system assigns a circuit in response to a request. The system assigns the circuit before an attempt to set up network paths to the three ports.

Register CNFSZRST release history

Register CNFSZRST was introduced before BCS20.

Associated registers

There are no associated registers.

Associated logs

There are no associated logs.

Register CNFTRU

CF3P traffic busy usage

OM group CF3P (continued)

Register CNFTRU is a usage register. Every 10 s the system scans the conference circuits, and CNFTRU records if the circuits are call processing busy, unloaded, or locked out.

The system uses this register in non-TOPS environments.

Register CNFTRU release history

Register CNFTRU was introduced before BCS20.

BCS33

When you set office parameter OMINERLANGS to Y, you convert the usage count from CCS to deci-erlangs before the count appears. Use the OMSHOW command on the ACTIVE class to display the usage count. The value in the active registers remains in CCS.

BCS20

Register modified to allow the system to record the usage count in deci-erlangs or CCS.

Associated registers

There are no associated registers.

Associated logs

There are no associated logs.

Register CNFTRUT

CF3P traffic busy usage TOPS environment (CNFTRUT)

Register CNFTRUT is a usage register. Every 10 s the system scans conference circuits, and CNFTRUT records if the circuits are call processing busy, deloaded, or locked out.

Register CNFTRUT release history

Register CNFTRUT was introduced before BCS20.

BCS20

Register modified to allow the system to record the usage count in deci-erlangs or CCS.

Associated registers

There are no associated registers.

Associated logs

There are no associated logs.

OM group CF3P (continued)

Register TOPSOVFL

CF3P overflows by TOPS positions (TOPSOVFL)

Register TOPSOVFL increases when a call that attempts to connect to a TOPS position cannot request a conference circuit. The request fails because circuits are not available for TOPS calls.

If this is the second attempt to obtain resources

- on an operator-initiated call, the operator does not observe a response and must re-initiate the call
- on a first operator-handled (that is, 0+, 0-, 1+ coin/hotel) call, the system routes the call to no service circuit (NOSC) treatment
- on a system-initiated recall, the system floats the call and does not use the recall indication.

Register TOPSOVFL release history

Register TOPSOVFL was introduced before BCS20.

Associated registers

There are no associated registers.

Associated logs

There are no associated logs.

Register TOPSTRU

CF3P TOPS traffic busy usage(TOPSTRU)

Register TOPSTRU is a usage register. Every 10 s the system scans the conference circuits. Register TOPSTRU records if the system assigned the circuits to calls being served at a TOPS position in non-CAMA mode.

Register TOPSTRU release history

Register TOPSTRU was introduced before BCS20.

Associated registers

There are no associated registers.

Associated logs

There are no associated logs.

Register TOPSZRS

CF3P seized by TOPS positions (TOPSZRS)

OM group CF3P (end)

Register TOPSZRS increases when the system assigns a three-port conference circuit to a call at a TOPS position. TOPSZRS increases when the system assigns the circuit before any attempt to set up the required network paths. TOPSZRS can increase a second time for the same call. TOPSZRS increases again if the call fails on the first attempt to obtain all the required resources.

The CAMA ONI/RONI and ANIF calls to TOPS positions do not use a conference circuit.

Register TOPSZRS release history

Register TOPSZRS was introduced before BCS20.

Associated registers

There are no associated registers.

Associated logs

There are no associated logs.

OM group CF6P

OM description

Six-port conference bridge measurements (CF6P)

The OM group CF6P provides information on the use of a six-port conference circuit.

Registers increase when:

- the system seizes a circuit
- the system makes a circuit not available
- a queue overflows
- the system abandons a queue

The following items request six-port conference circuits:

- lines that use the Six-way Conference (6WC) feature
- calls that go to service analysis positions after the activation of the position
- trunk test positions (TTP) when the user issues a request to monitor talking.

Release history

The OM group CF6P was introduced before BCS20.

APC005

Functionality is added to support Meridian Digital Centrex (MDC) features, like 6WC, on Global Peripheral Platform (GPP) lines for:

- ANSI ISDN telephone user part (ATUP)
- ANSI ISDN user part (ANSI ISUP)
- Australian ISUP (AISUP) trunk signaling

BCS33

The system can convert registers CF6TRU, CF6SBU, and CF6MBU from hundred call seconds (CCS) to deci-erlangs before the register appears. Use the OMSHOW command on the active class to display the register.

Registers

The OM group CF6P registers appear on the MAP terminal as follows:

OM group CF6P (continued)

CF6SZRS	CF6OVFL	CF6QOCC	CF6QOVFL
CF6QABAN	CF6TRU	CF6SBU	CF6MBU

Group structure

The OM group CF6P provides one register for each office.

Key field:

COMMON_LANGUAGE_NAME

Info field:

CONF6_OM_INFO

Associated OM groups

There are no associated OM groups.

Associated functional groups

There are no associated functional groups.

Associated functionality codes

The associated functionality codes for OM group CF6P appear in the following table.

Functionality	Code
Integrated Business Networks-Basic (IBN)	NTX100AA
DMS-250 Translation Verification	NTX238AA

OM group CF6P (continued)

OM group CF6P registers

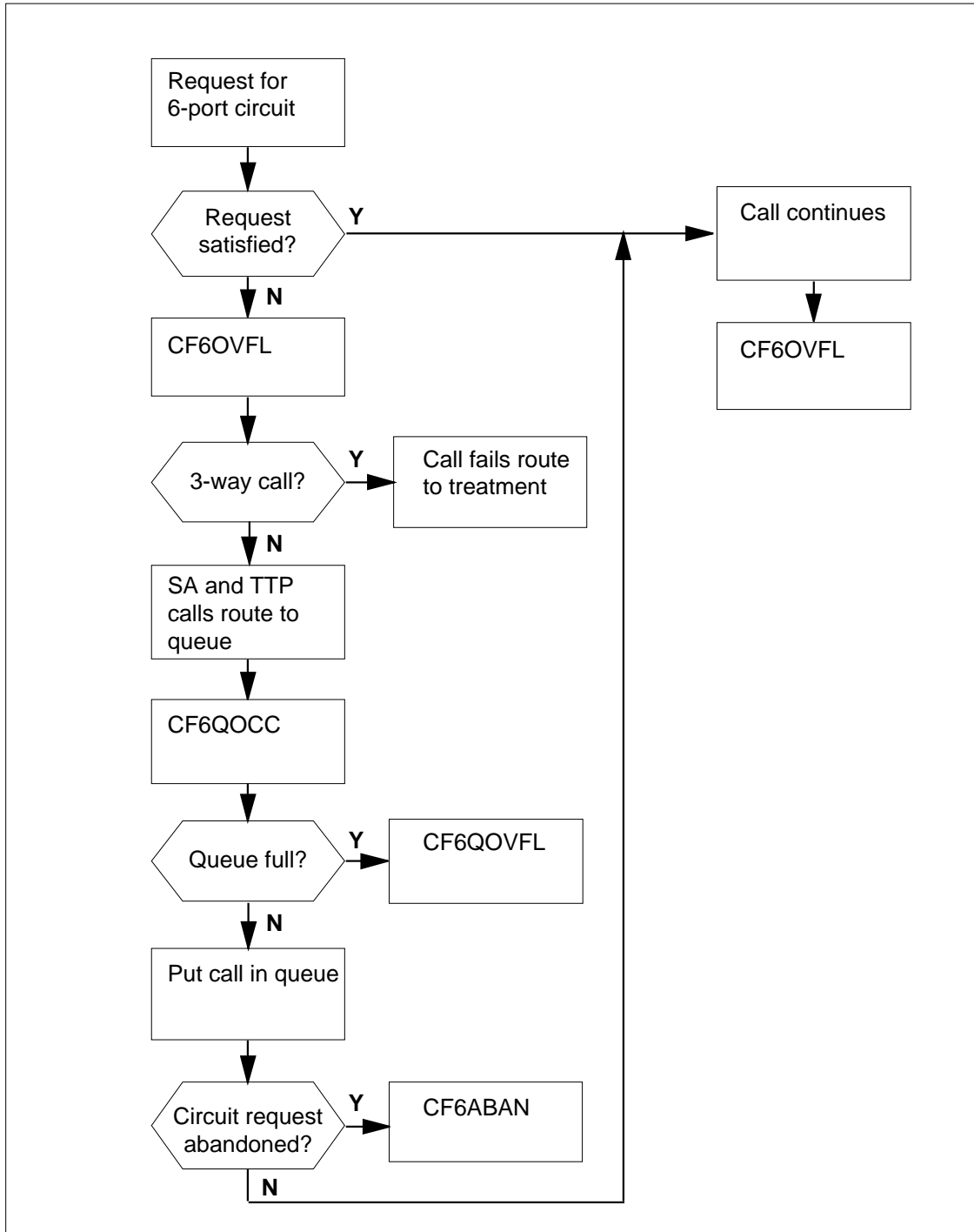

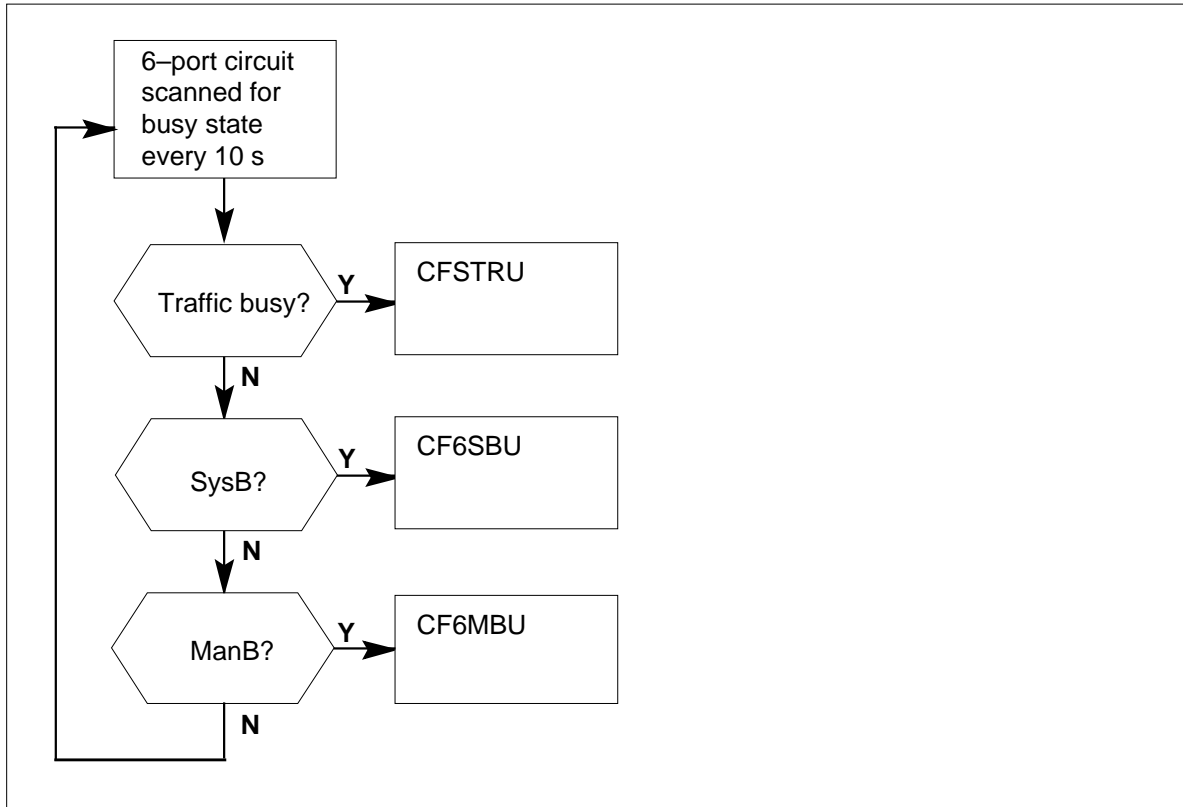
OM group CF6P (continued)**OM group CF6P registers (continued)****Register CF6MBU**

CF6P manual busy usage (CF6MBU)

Register CF6MBU is a usage register. Every 10 s, the system scans conference circuits. Register CF6MBU records the number of conference circuits in any of the following states during the last OM transfer period:

- manual busy
- seized
- busy (because of network management procedures (NWM))

The items in the following list can seize a circuit for diagnostic tests:

- maintenance personnel that work from a trunk test position at the MAP terminal
- the automatic trunk test (ATT) system
- a system audit on the conference ports.

OM group CF6P (continued)

The system updates the active register every 10 s with the number of CF6Ps that are in any of these states. If one conference port is manually busy, the register increases. The register also increases if the system seizes one of the ports for a system audit. The register increases by 1 every 10 s for as long as the port is in this state. The system copies the accumulated count to the holding register (CF6MBU) every 30 min (and erases the previous value). Register CF6MBU shows a value that is not zero if the system counts a port during the last OM transfer period (30 min). Register CF6MBU displays this value when ports are not in busy states.

Register CF6MBU release history

Register CF6MBU was added before BCS20.

BCS33

When you set office parameter OMINERLANGS to Y, the system converts the usage count from CCS to deci-erlangs before the count appears. Use the OMSHOW command on the ACTIVE class to display the usage count. The value in the active registers remains in CCS.

Associated registers

There are no associated registers.

Associated logs

There are no associated logs.

Extension registers

There are no extension registers.

Register CF6OVFL

CF6P overflow (CF6OVFL)

Register CF6OVFL counts calls that cannot locate enough conference bridges.

Register CF6OVFL release history

Register CF6OVFL was introduced before BCS20.

Associated registers

There are no associated registers.

Associated logs

The system generates ATB100 when an attempt to seize a trunk to a exact numbering plan area or central office blocks.

OM group CF6P (continued)

Extension registers

There are no extension registers.

Register CF6QABAN

CF6P queue abandons

Register CF6QABAN counts calls that abandon while waiting in queue for the system to connect the calls to a conference circuit.

Register CF6QABAN release history

Register CF6QABAN was introduced before BCS20.

Associated registers

There are no associated registers.

Associated logs

The system generates LINE104 when the system encounters problems during call processing.

The system generates LINE105 when the system encounters problems during call processing.

The system generates LINE109 when the system encounters problems during call processing.

The system generates LINE204 when the system encounters problems during call processing.

Extension registers

There are no extension registers.

Register CF6QOCC

CF6P queue occupancy (CF6QOCC)

Register CF6QOCC is a usage register. The scan rate is 10 s. Register CF6QOCC records if requests are in queue for the system to assign a conference circuit. The queue consists of waiting service analysis and trunk test position requests only.

Register CF6QOCC release history

Register CF6QOCC was introduced before BCS20.

OM group CF6P (continued)

Associated registers

There are no associated registers.

Associated logs

There are no associated logs.

Extension registers

There are no extension registers.

Register CF6QOVFL

CF6P queue overflow (CF6QOVFL)

Register CF6QOVFL counts requests for a conference circuit that encounter a circuit queue full condition.

Register CF6QOVFL release history

Register CF6QOVFL was introduced before BCS20.

Associated registers

There are no associated registers.

Associated logs

The system generates LINE138 when the system routes a call to a treatment after it is call processing busy.

The system generates TRK138 when the system routes a call to a treatment after it is call processing busy.

Extension registers

There are no extension registers.

Register CF6SBU

CF6P system busy usage (CF6SBU)

Register CF6SBU is a usage register. The scan rate is 10 s. Register CF6SBU records if conference circuits are in one of the following states. The circuits are in this state as a result of a busying that originated in the system:

- remote busy
- peripheral module busy
- system busy

OM group CF6P (continued)

- carrier fail
- unloaded

Register CF6SBU release history

Register CF6SBU was introduced before BCS20.

BCS33

When office parameter OMINERLANGS is set to Y, the system converts the usage count from CCS to deci-erlangs. Conversion is done before to their display using the OMSHOW command on the ACTIVE class. The value held in the active registers is not altered and remains in CCS.

Associated registers

There are no associated registers.

Associated logs

The system generates TRK106 when a diagnostic test on trunk equipment fails.

Extension registers

There are no extension registers.

Register CF6SZRS

CF6P Seizures (CF6SZRS)

Register CF6SZRS counts calls that seize a conference circuit.

Register CF6SZRS release history

Register CF6SZRS was introduced before BCS20.

Associated registers

There are no associated registers.

Associated logs

There are no associated logs.

Extension registers

There are no extension registers.

Register CF6TRU

CF6P traffic busy usage (CF6TRU)

OM group CF6P (end)

Register CF6TRU0 is a usage register. The scan rate is 10 s. CF6TRU records if conference circuits are in the following states:

- call processing busy
- call processing busy unload
- lockout

Register CF6TRU release history

CF6TRU is added prior to BCS20.

BCS33

When the office parameter OMINERLANGS is set to Y, the system converts the usage count from CCS to deci-erlangs. Conversion takes place before to their display using the OMSHOW command on the ACTIVE class. The value held in the active registers is not altered and remains in CCS.

Associated registers

There are no associated registers.

Associated logs

There are no associated logs.

Extension registers

There are no extension registers.

OM group CM

OM description

Computing module (CM)

The OM group CM provides information on the performance of the computing module (CM). The computing module is the control component of a DMS SuperNode switch. The CM performs call processing and maintenance functions. The computing module consists of the following duplicated central processing units (CPU), memory, message controllers (MC) and subsystem clocks (SSC).

Twenty-three peg registers count:

- manual and system requests for switches of activity (SWACT)
- SWACTs that a routine exercise test (REx) cause
- warm restarts that a system or manual action cause
- cold restarts that a system or manual action cause
- transient mismatches
- loss of sync that mismatch interrupts cause
- fault traps
- faults in the CPU, memory, or SSC
- aborted REx tests
- system busy MCs
- system-busy peripheral module controller (PMC) nodes or ports
- failed REx tests of a CPU, memory, LINK or PMC class
- failed SSC section of LINK class REx

CM has three usage registers that record which of the following reasons causes the CM to operate out-of-sync:

- manual or system action
- REx tests

The system uses data that the CM provides to assess the performance of the computing module. The system also uses the data to monitor fault interrupts and resource outages.

Release history

OM group CM was introduced in BCS22.

OM group CM (continued)

BASE06

The system deletes CMRMCFL and CMRSSCFL from registers of MAP display and from flow chart.

BCS30

The system deletes CMRMCFL and CMRSSCFL.

BCS28

The system sets CMRMCFL and CMRSSCFL to zero and adds CMRLNKFL.

BCS25

The system adds CMRPMCFL.

BCS24

The system adds PMCNDBSY and PMCLKBSY.

Registers

The OM group CM registers display on the MAP terminal as follows:

CMSSWACT	CMMSWACT	CMRSWACT	CMSWINIT
CMMWINIT	CMSCINIT	CMMCINIT	CMTRMISM
CMDPSYNC	CMTRAP	CMCPUFLT	CMMEMFLT
CMSSCFLT	CMMSBSY	CMREXFLT	CMRCPUFL
CMRMEMFL	CMSSMPXU	CMMSMPXU	CMRSMPXU
PMCNDBSY	PMCLKBSY	CMRPMCFL	CMRLNKFL
CMRBASFL	CMRFULFL		

Group structure

The OM group CM provides one tuple for each office.

Key field:

There is no Key field

Info field:

There is no Info field

Associated OM groups

The OM group SLM provides information on the system load module (SLM).

Associated functional groups

There are no associated functional groups.

OM group CM (continued)

Associated functionality codes

The associated functionality codes for OM group CM appear in the following table.

Functionality	Code
SuperNode SN-20 Processor	NTXF70AA
DMS SuperNode System Load Module	NTX942AA

OM group CM (continued)

OM group CM registers

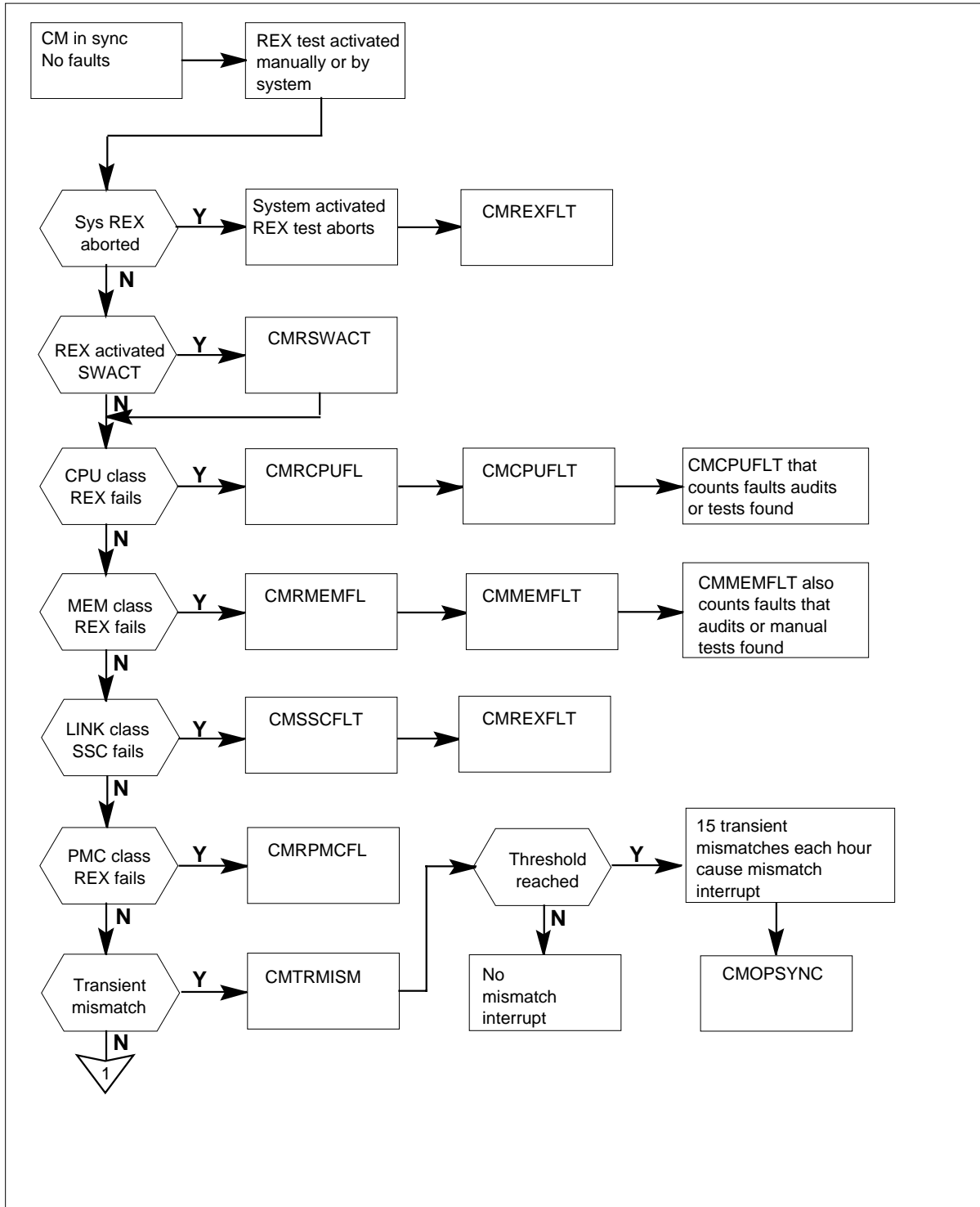

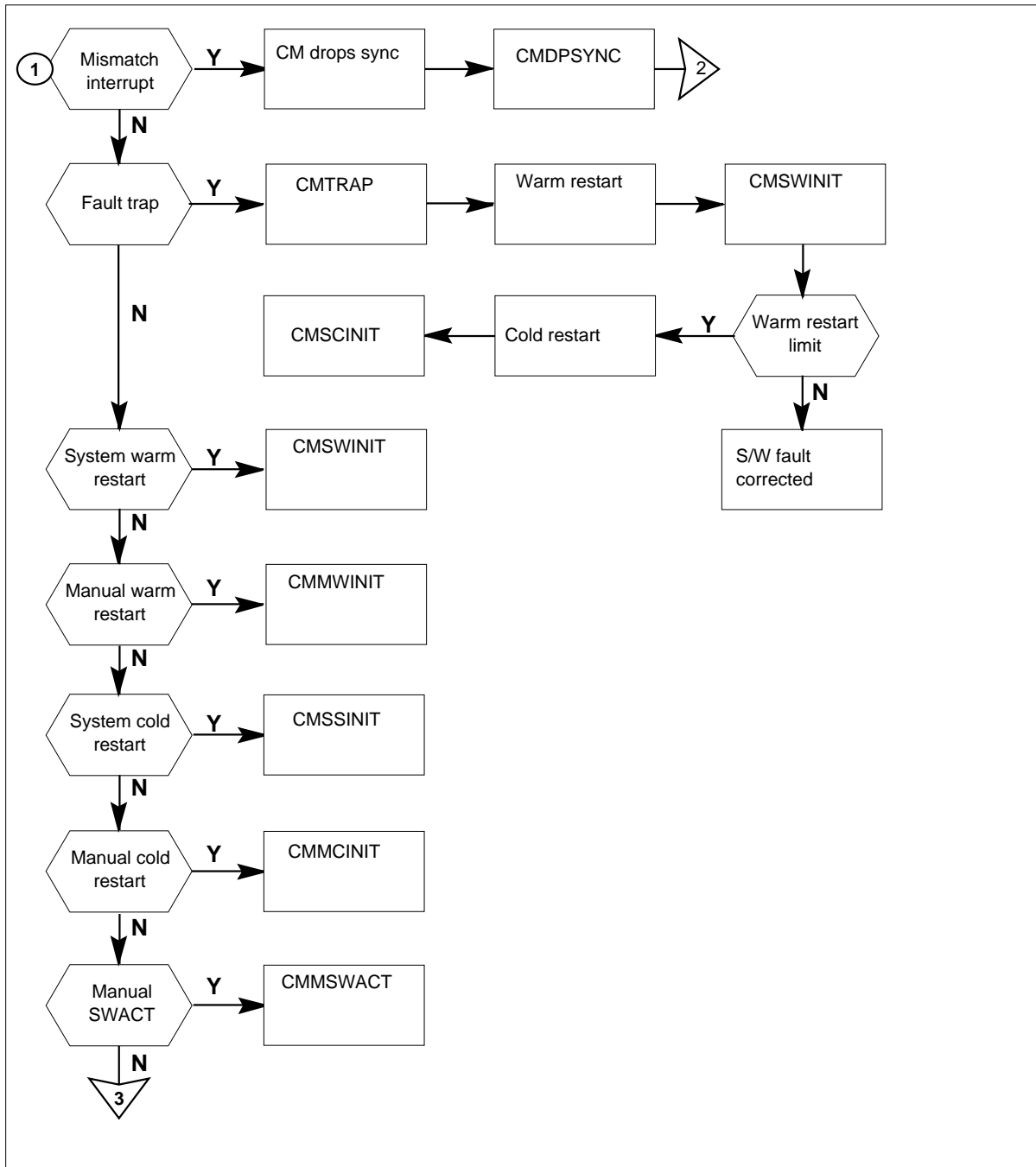
OM group CM (continued)**OM group CM registers (continued)**

OM group CM (continued)

OM group CM registers (continued)

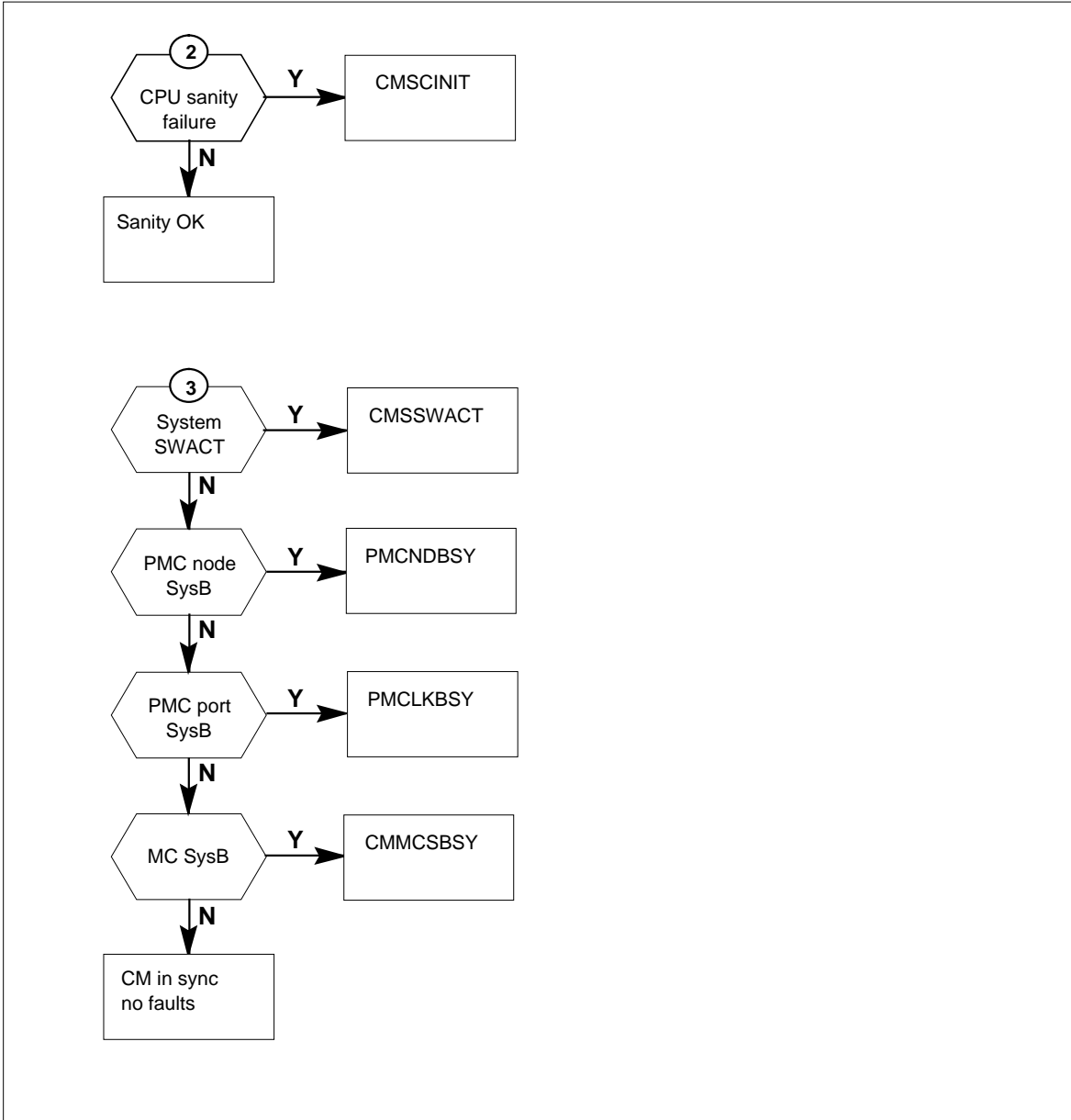

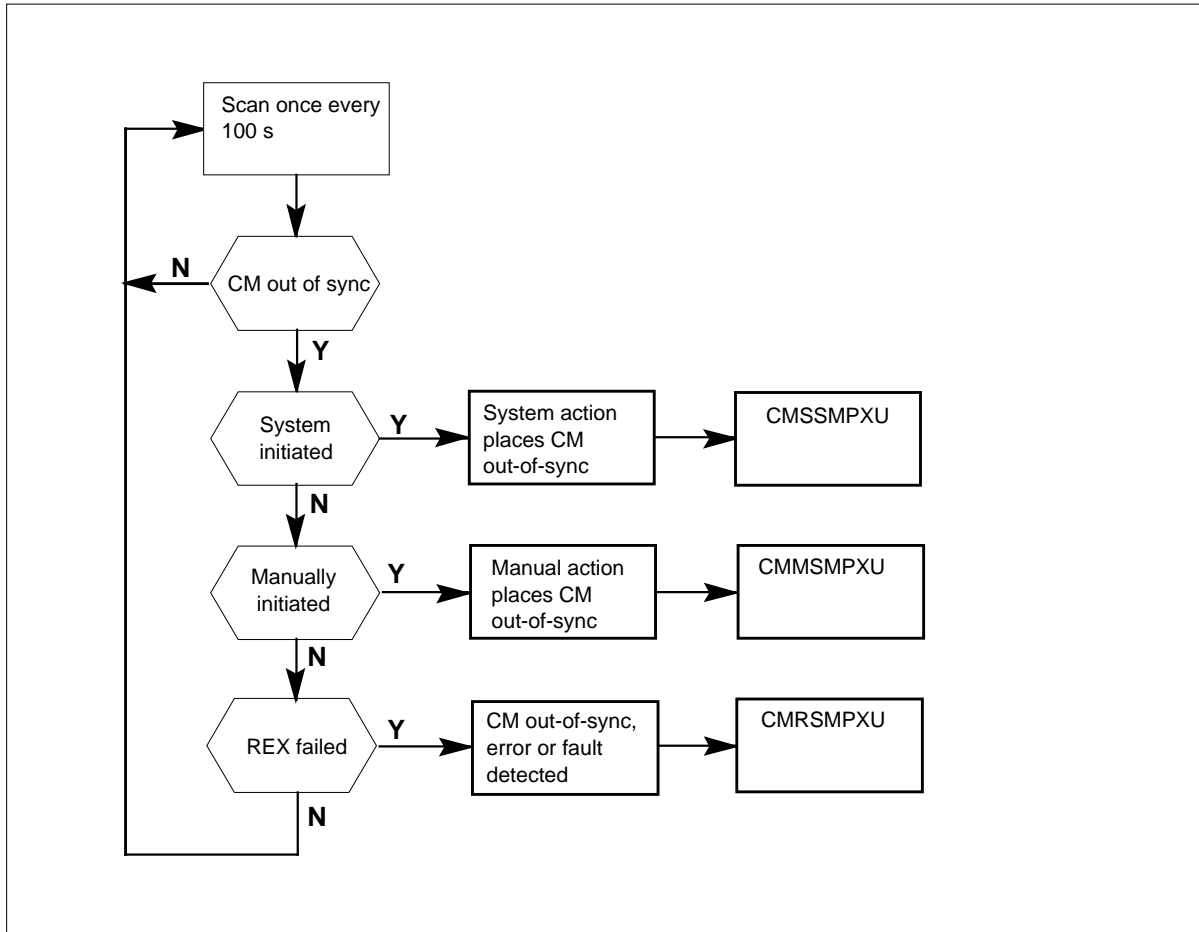
OM group CM (continued)**OM group CM registers (continued)****Register CMCPUFLT**

Computing module central processing unit faults (CMCPUFLT)

Register CMCPUFLT increases when the system deletes a fault in a CPU.

Register CMCPUFLT release history

Register CMCPUFLT was introduced in BCS22.

Associated registers

Register CMMEMFLT increases when the system detects a memory fault in the CM.

Register CMSSCFLT increases when the system detects a subsystem clock (SSC) fault in the CM.

OM group CM (continued)

Register CMREXFLT increases when a system-activated CM REx test aborts.

Associated logs

The system generates CM125 when a CPU test fails.

Register CMDPSYNC

Computing module dropped sync (CMDPSYNC)

Register CMDPSYNC increases when the CM loses synchronization because of a mismatch interrupt. A mismatch interrupt occurs when one of the following occurs

- a fault mismatch
- 15 transient mismatches in one hour

Register CMDPSYNC release history

Register CMDPSYNC was introduced in BCS22.

Associated registers

Register CMTRMISM counts transient mismatches in the CM.

Associated logs

The system generates MM101 when a transient mismatch occurs.

Register CMMCINIT

Computing module manual cold initialization (CMMCINIT)

Register CMMCINIT when a manual request causes a cold restart of CM software and memory.

Register CMMCINIT release history

Register CMMCINIT was introduced in BCS22.

Associated registers

Register CMMWINIT increases when a manual request causes a warm restart of CM software and memory.

Register CMSCINIT increases when a system request causes a cold restart of CM software and memory.

Register CMSWINIT increases when a system request causes a warm restart of CM software and memory.

OM group CM (continued)

Associated logs

The system generates CM120 when a system-initiated restart occurs.

Register CMMCSBSY

Computing module message controller system busy

Register CMMCSBSY increases when makes a message controller (MC) system busy. This increase will occur because of faults or because both MC links are system busy.

Register CMMCSBSY increases when an MC changes state to system busy during the execution of a REx test.

Register CMMCSBSY release history

Register CMMCSBSY was introduced in BCS22.

Associated registers

There are no associated registers.

Associated logs

The system generates CM104 when an MC change state to system busy.

Register CMMEMFLT

Computing module memory faults

CMMEMFLT counts memory faults in the CM that:

- affect a memory module or the complete memory card
- require system or manual interruption

The following cause memory faults:

- test failures
- defective store
- transient soft errors

Register CMMEMFLT release history

CMMEMFLT was introduced in BCS22.

Associated registers

Register CMCPUFLT increases when the system detects a CPU fault.

OM group CM (continued)

Register CMSSCFLT increases when the system detects a fault in the CM subsystem clock (SSC).

Register CMREXFLT increases a system-activated CM REx test aborts.

Associated logs

The system generates CM112 when a memory card fails a test.

The system generates CM113 when a memory card changes state to in-service trouble (ISTB).

Register CMMSMPXU

Computing module manual out-of-sync usage

Register CMMSMPXU is a usage register. The scan rate is slow: 100 s. Register CMMSMPXU records if the CM is out of sync (simplex mode) because of a manual request.

The system places CM in simplex mode. To place the CM in a simplex mode, the system inputs the DPSYNC or IMAGE commands at the MAP terminal.

Register CMMSMPXU release history

Register CMMSMPXU was introduced in BCS22.

Associated registers

Register CMSSMPXU records if the CM is out-of-sync because of a system action.

Register CMRSMPXU records if the CM is out-of-sync because of errors or that a REx test detected.

Associated logs

The system generates CM102 every hour while the CM is out of sync.

The system generates CM117 when a successful image test completes.

Register CMMSWACT

Computing module manual switch of activity (CMMSWACT)

Register CMMSWACT increases when a manual request causes a switch of activity (SWACT) in the CM.

OM group CM (continued)

The system initiates manual switches of activity when the system performs the following actions at the MAP terminal:

- inputs the SWACT command
- complete tests of a message controller (MC) or time of day (TOD) clock

Register CMMSWACT release history

Register CMMSWACT was introduced in BCS22.

Associated registers

Register CMSSWACT increases when a system request causes a switch of activity in the CM.

Register CMRSWACT increases when a REx test causes a switch of activity in the CM.

Associated logs

The system generates CM101 when a switch of activity is present in the CM.

Register CMMWINIT

Computing module manual warm initialization (CMMWINT)

Register CMMWINIT increases when a manual request causes a warm restart of CM software and memory.

To produce a manual restart, the system inputs the restart command at the reset terminal interface (RTIF). To perform manual restart, you can also input non-menu commands at the command interpreter (CI) level.

Register CMMWINIT release history

Register CMMWINIT was introduced in BCS22.

Associated registers

Register CMSCINIT increases when a system request causes a cold restart of the CM.

Register CMSWINIT increases when a system request causes a warm restart of the CM.

Register CMMCINIT increases when a manual request causes a cold restart of the CM.

Associated logs

The system generates CM120 when a system-initiated restart occurs.

OM group CM (continued)

Register CMRCPUFL

Computing module routine exercise test central processing unit class failure

The system increases CMRCPUFL when a system or manually activated CPU class REx test fails.

Scheduled REx tests run daily. The data that CMRCPUFL collects are meaningful only when accumulated over a period of a week or a month.

Register CMRCPUFL release history

Register CMRCPUFL was introduced in BCS22.

Associated registers

The system increases CMREXFLT when a system activated CM REx test aborts.

Register CMRMEMFL increases when a CM memory REx test fails.

Register CMRSSCFL increases when an SSC REx test fails.

Register CMRMCFL increases when an MC REx test fails.

Register CMRPMCFL increases when a PMC REx test fails.

Associated logs

The system generates CM122 when a system or manually requested REx test fails.

Register CMREXFLT

Computing module routine exercise test fault

Register CMREXFLT increases when a system-activated CM REx test aborts because of one of the following:

- the system jams the mate CPU to the inactive state
- the mate CPU is already under test
- the CM is out-of-sync
- the system disables the REx test

The system does not increase CMREXFLT when a manually requested REx test aborts. REx tests run daily. The data that CMREXFLT collects are meaningful only when accumulated over a period of a week or a month.

OM group CM (continued)

Register CMREXFLT release history

Register CMREXFLT was introduced in BCS22.

Associated registers

The system increases CMRCPUFL when a CPU REx test fails.

The system increases CMRMEMFL when a CM memory REx test fails.

The system increases CMRSSCFL when an SSC REx test fails.

The system increases CMRMCFL when an MC REx test fails.

The system increases CMRPMCFL when a PMC REX test fails.

Associated logs

The system generates CM122 when a system or manually activated REx test fails.

Register CMRLNKFL

Computing module link class routine exercise test failures

Register CMRLNKFL counts failures of the link class (REx) test in the computing module of the DMS-core. The system can manually initiate this test with the REXtst command at the MAP terminal. The system can initiate the test according to a schedule set by the operating company. The link class REx test class includes the subsystem clock and message controller.

Register CMRLNKFL release history

Register CMRLNKFL was introduced in BCS28.

Associated registers

Register CMRLNKFL replaces CMRSSCFL and CMRMCFL.

Associated logs

The system generates CM122 reports when any REx test fail.

Register CMRMEMFL

Computing module routine exercise test MEM class failure (CMRMEMFL)

The system increases CMRMEMFL when a system or manually activated CM MEM class REx test fails.

OM group CM (continued)

REx tests are scheduled to run daily. The data collected in CMRMEMFL is only meaningful when accumulated over a period of a week or a month.

Register CMRMEMFL release history

Register CMRMEMFL was introduced in BCS22.

Associated registers

Register CMREXFLT increases when a system-activated CM REx test aborts.

Register CMRCPUFL increases when a CPU REx test fails.

Register CMRSSCFL increases when an SSC REx test fails.

Register CMRMCFL increases when an MC REx test fails.

Register CMRPMCFL increases when a PMC REx test fails.

Associated logs

The system generates CM122 when a system or manually requested REx test fails.

Register CMRPMCFL

Computing module routine exercise test PMC class peripheral module controller failures (CMRPMCFL)

Register CMRPMCFL increases when a system or manually activated PMC class REx test fails.

Register CMRPMCFL release history

Register CMRPMCFL was introduced in BCS25.

Associated registers

Register CMREXFLT when the system aborts a system activated CM REx test.

Register CMRCPUFL increases when a CPU REx test fails.

Register CMRMEMFL increases when a CM memory REx test fails.

Register CMRMCFL increases when an MC REx test fails.

Register CMRSSCFL increases when an SSC REx test fails.

OM group CM (continued)

Associated logs

The system generates CM122 when the system runs a REx test correctly.

Register CMRSMPXU

Computing module routine test out-of-sync usage.

Register CMRSMPXU is a usage register. The scan rate is slow: 100 s. Register CMRSMPXU records if the computing module (CM) is out-of-sync because of errors or faults that a routine exercise (REx) test detected.

Register CMRSMPXU does not increase when the CM drops sync during a normal REx test.

Register CMRSMPXU release history

CMRSMPXU was introduced in BCS22.

Associated registers

Register CMSSMPXU records if the CM is out of sync because of a system action.

Register CMMSMPXU records if the CM is out of sync because of a manual request.

Associated logs

The system generates CM102 every hour while the CM is out of sync.

The system generates CM121 when the system runs a REx test correctly.

Register CMRSWACT

Computing module routine exercise switch of activity

The system increases CMRSWACT when a REx test causes a switch of activity in the CM.

The REx test switches CPU activity daily to make sure that both sides of the CM hardware work. Three activity switches occur during a CM REx test.

Register CMRSWACT release history

Register CMRSWACT was introduced in BCS22.

Associated registers

Register CMSSWACT increases when a system request causes a switch of activity in the CM.

OM group CM (continued)

Register CMMSWACT increases when a manual request causes a switch of activity in the CM.

Associated logs

The system generates CM101 when there is a switch of activity in the CM.

Register CMSCINIT

Computing module system cold initialization (CMSCINIT)

The system increases CMSCINIT when a system request causes a cold restart of CM software and memory.

The system initiates a cold restart if one of the following occurs:

- the system isolates the CM by closed MC links
- the system drops synchronization and must test the inactive CPU image
- a CPU is off-line and is about to receive activity
- a CPU sanity test fails after a mismatch interrupt occurs
- the system reached the allowed limit for warm restarts and the system requires a restart
- damage of the permanent store area
- the queues are defective

Register CMSCINIT release history

Register CMSCINIT was introduced in BCS22.

Associated registers

Register CMMWINIT increases when a manual request causes a warm restart of the CM.

Register CMSWINIT increases when a system request causes a warm restart of the CM.

Register CMMCINIT increases when a manual request causes a cold restart of the CM.

Associated logs

The system generates CM120 when a system-initiated restart occurs.

Register CMSSCFLT

Computing module subsystem clock faults (CMSSCFLT)

OM group CM (continued)

Register CMSSCFLT increases when a subsystem clock (SSC) fault is detected in the CM.

Register CMSSCFLT release history

CMSSCFLT was introduced in BCS22.

Associated registers

Register CMCPUFLT increases when the system detects a CPU fault.

Register CMMEMFLT increases when the system detects a memory fault in the CM.

Register CMREXFLT increases when system-activated CM REx test aborts.

Associated logs

There are no associated logs.

Register CMSSMPXU

Computing module system out-of-sync usage (CMSSMPXU)

Register CMSSMPXU is a usage register. The scan rate is 100 s. Register CMSSMPXU records if the CM is out of sync (simplex mode) because of a system action.

The system places the CM out-of-sync when:

- the system detects a mismatch defect
- the number of transient mismatches reaches the threshold

The CM remains out-of-sync until system or manual action completes.

Register CMSSMPXU release history

Register CMSSMPXU was introduced in BCS22.

Associated registers

Register CMMSMPXU records if the CM operates out-of-sync because of a manual request.

Register CMRSMPXU records if the CM operates out-of-sync because a REx test deleted errors or faults .

Associated logs

The system generates CM102 every hour while the CM is out of sync.

OM group CM (continued)

The system generates CM120 when a system restart occurs.

The system generates MM100 when a fault mismatch occurs in the CM.

The system generates MM101 when the CM is out of sync.

Register CMSSWACT

Computing module system switch of activity (CMSSWACT)

Register CMSSWACT increases when a system request causes a switch of activity (SWACT) in the CM. The SWACT preserves processor sanity after a mismatch interrupt occurs.

Register CMSSWACT release history

CMSSWACT was introduced in BCS22.

Associated registers

The system increases CMMSWACT when a manual request causes a switch of activity in the CM.

The system increases CMRSWACT when a REx test causes a switch of activity in the CM.

Associated logs

The system generates CM101 when a switch of activity is present in the CM.

The system generates MM100 when a fault mismatch occurs.

Register CMSWINIT

Computing module system warm initialization (CMSWINT)

The system increases CMSWINIT when a system request causes a warm restart of CM software and memory.

System-initiated warm restarts correct the following problems:

- software traps
- failure to create system processes
- death of system processes
- corrupt or insufficient store
- errors
- time-outs

OM group CM (continued)

Register CMSWINIT release history

Register CMSWINIT was introduced in BCS22.

Associated registers

Register CMMWINIT increases when a manual request causes a warm restart of the CM.

Register CMSCINIT increases when a system request causes a cold restart of the CM.

Register CMMCINIT increases when a manual request causes a cold restart of the CM.

Associated logs

The system generates CM120 when a system-initiated restart occurs.

Register CMTRAP

Computing module trap

Register CMTRAP counts trap interrupts in the CM. Trap interrupts occur when the system detects an error that causes a trap.

Register CMTRAP release history

Register CMTRAP was introduced in BCS22.

Associated registers

There are no associated registers.

Associated logs

The system generates CM100 each day at 0900 h. CM 100 provides a summary of CM status information.

The system generates CM103 when a large number of traps occur in the CM.

The system generates CM119 when a trap occurs in the CM.

Register CMTRMISM

Computing module transient mismatches (CMTRMISM)

Register CMTRMISM counts transient mismatches in the CM.

Transient mismatches occur when the system cannot isolate faults. These mismatches do not cause the CM to go out-of-sync unless 15 mismatches

OM group CM (continued)

occur within one hour. When the system reaches this threshold, the CM goes out-of-sync until you correct the problem.

Register CMTRMISM release history

Register CMTRMISM was introduced in BCS22.

Associated registers

There are no associated registers.

Associated logs

The system generates MM101 when a transient mismatch occurs.

Register PMCLKBSY

Peripheral module controller link system busy (PMCLKBSY)

Register PMCLKBSY increases when the system makes a peripheral module controller (PMC) port system busy.

Register PMCLKBSY increases when the system makes a PMC port system busy during the execution of a REx test.

Register PMCLKBSY release history

Register PMCLKBSY was introduced in BCS24.

Associated registers

Register PMCNDBSY increases when the system makes a PMC node system busy.

Associated logs

The system generates CM137 when the system makes a PMC port system busy.

Register PMCNDBSY

Peripheral module controller node system busy (PMCNDSBY)

Register PMCNDBSY increases when the system makes a peripheral module controller (PMC) node system busy.

Register PMCNDBSY does not increase when the system makes a PMC node system busy in a REx test.

Register PMCNDBSY release history

PMCNDBSY was introduced in BCS24.

OM group CM (end)

Associated registers

Register PMCLKBSY increases when the system makes a PMC port system busy.

Associated logs

The system generates CM133 when a system makes a PMC node system busy.

Register CMRBASFL

Computing Module Routine Exercise BASE Class Fault (CMRBASFL)

Register CMRBASFL increases when a test fails within the BASE class.

The BASE class is a small group of tests that make sure the inactive processor is sane. Complete the test before the system moves the activity over to the mate. If a fault is present on the inactive plane, the system pegs a fault against the OM for each failed test.

Register CMRBASFL release history

Register CMRBASFL was introduced in BAS05.

Associated registers

There are no associated registers.

Associated logs

There are no associated logs.

Register CMRFULFL

Computing Module Exercise FULL Class Fault (CMRFULFL)

Register CMRFULFL increases when a test fails in the FULL class.

The FULL class encompasses the measure of REx tests that include CPU, MEM, LINK, PMC, and BASE. If any of these tests fail while the system executes a full class, faults will be individually pegged against this OM.

Register CMRFULFL release history

Register CMRFULFL was introduced in BAS05.

Associated registers

There are no associated registers.

Associated logs

There are no associated logs.

OM group CP

OM description

Call processing software resources

CP provides information on the use of call processing software resources such as call condense blocks, call processes, multiblocks, wakeup blocks, and long buffers. CP contains 27 peg registers.

CP is provided for all types of DMS switch offices.

Release history

OM group CP was introduced prior to BCS20.

CSP18/SN05

Extension registers CPLOSZ2, CINITC2, and WAKESZ2 introduced.

GSF031

Register ORIGDENY is pegged in the Generic Services Framework (GSF) environment.

BCS26

Added registers INLBSZ, INLBSZ2, INLBOVFL, and CPLBOOVF.

BCS25

Deleted registers CCBTRU, CPTRU, CPLTRU, OUTBRTU, MULTRU, WAKETRU.

BCS24

Zeroed registers CCBTRU, CPTRU, CPLTRU, OUTBRTU, MULTRU, and WAKETRU, and deleted register CPLLOW.

BCS23

Zeroed register CPLLOW. When the guaranteed dial tone queue is full and dial tone cannot be guaranteed, register ORIGDENY is incremented.

BCS22

Added that register ORIGDENY counts originations ignored by the central control (CC) due to overload.

BCS21

Software change to provide usage counts either in CCS or in deci-erlangs.

OM group CP (continued)**BCS20**

If register ORIGDENY is incremented, a call origination is lost.

Registers

OM group CP registers display on the MAP terminal as follows:

CCBSZ	CCBSZ2	CCBOVFL	CPSZ
CPSZ2	CPTRAP	CPSUIC	ORIGDENY
WAITDENY	CPLSZ	CPLSZ2	CPLOOVFL
CPLPOVFL	CPLOSZ	OUTBSZ	OUTBOVFL
MULTSZ	MULTOVFL	WAKESZ	WAKEOVFL
CINITC	WINITC	INITDENY	INLBSZ
INLBSZ2	INLBOVFL	CPLBOOVF	CPLOSZ2
CINITC2	WAKESZ2		

Group structure

OM group CP provides one tuple per office. Each tuple consists of 30 registers.

Key field:

None

Info field:

There are six information fields. The first always has value zero. The remaining five contain the number of CP letters, wakeup blocks, call processes, call condense blocks, and longbuffers that are provisioned for the office.

Two tables must be datafilled: OFCENG and OFCSTD.

The office parameter NCCBS, in table OFCENG, defines the number of call condense blocks.

The office parameter NUMCALLPROCESSES, in table OFCENG, defines the number of call processes.

The office parameter NUMCPWAKE, in table OFCENG, defines the number of wakeup blocks.

Associated OM groups

CP2 extends OM group CP. It measures the use of extended call control blocks and reflects the maximum number of selected call processing resources in simultaneous use during each OM transfer period.

OM group CP (continued)

Associated functional groups

None

Associated functionality codes

The functionality codes associated with OM group CP are shown in the following table.

Functionality	Code
Common Basic	NTX001AA
International—Call Processing System	NTX485AA
International—Common Basic	NTX470AA
OMs in Erlangs	NTX664AA
Enhanced Real Time Indicator	NTX291AA
NonRes NT Support Software	NTX181AA
International—Local Basic (UPGR NTX472AA)	NTX472AB

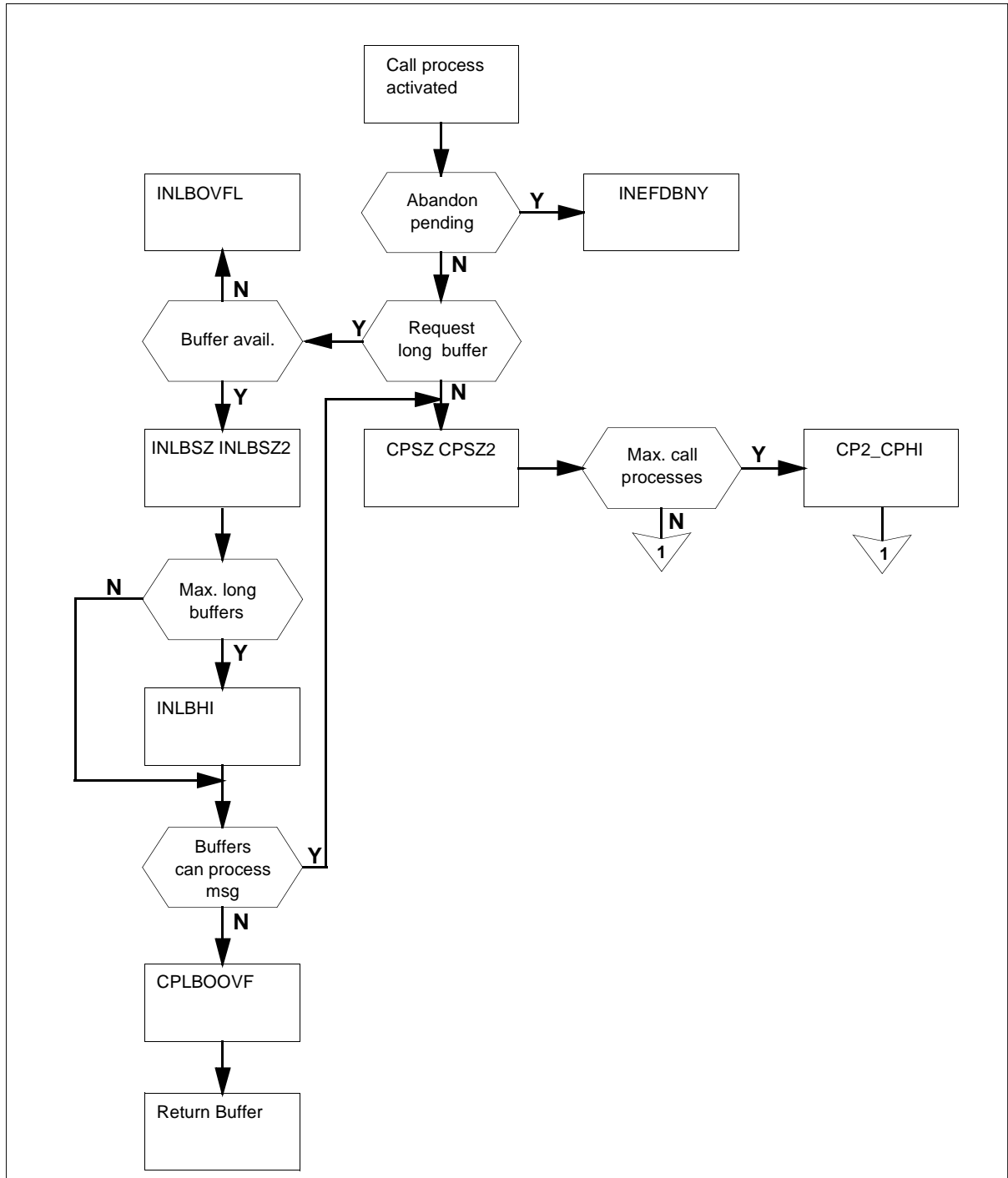
OM group CP (continued)**OM group CP registers**

OM group CP (continued)

OM group CP registers (continued)

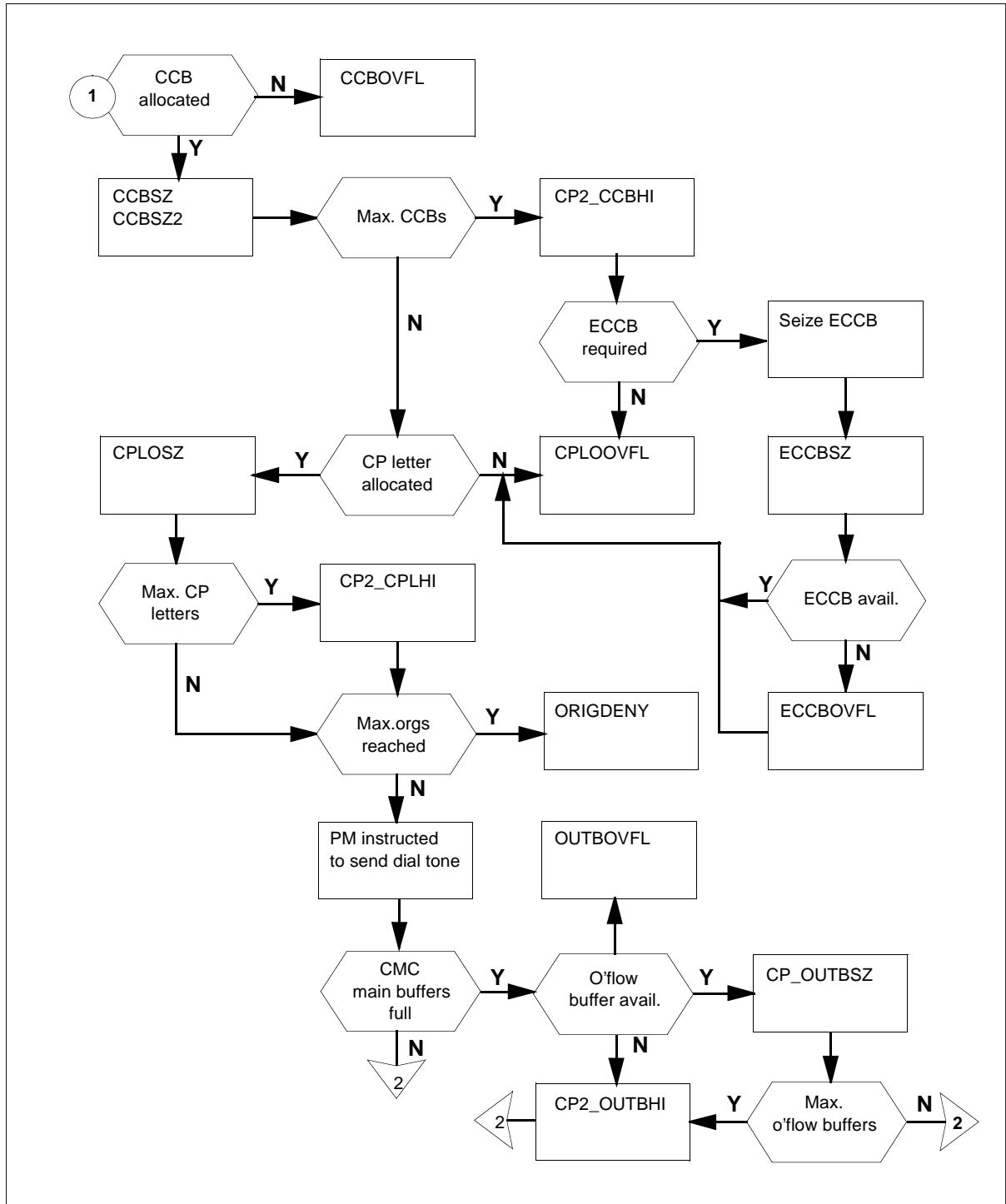

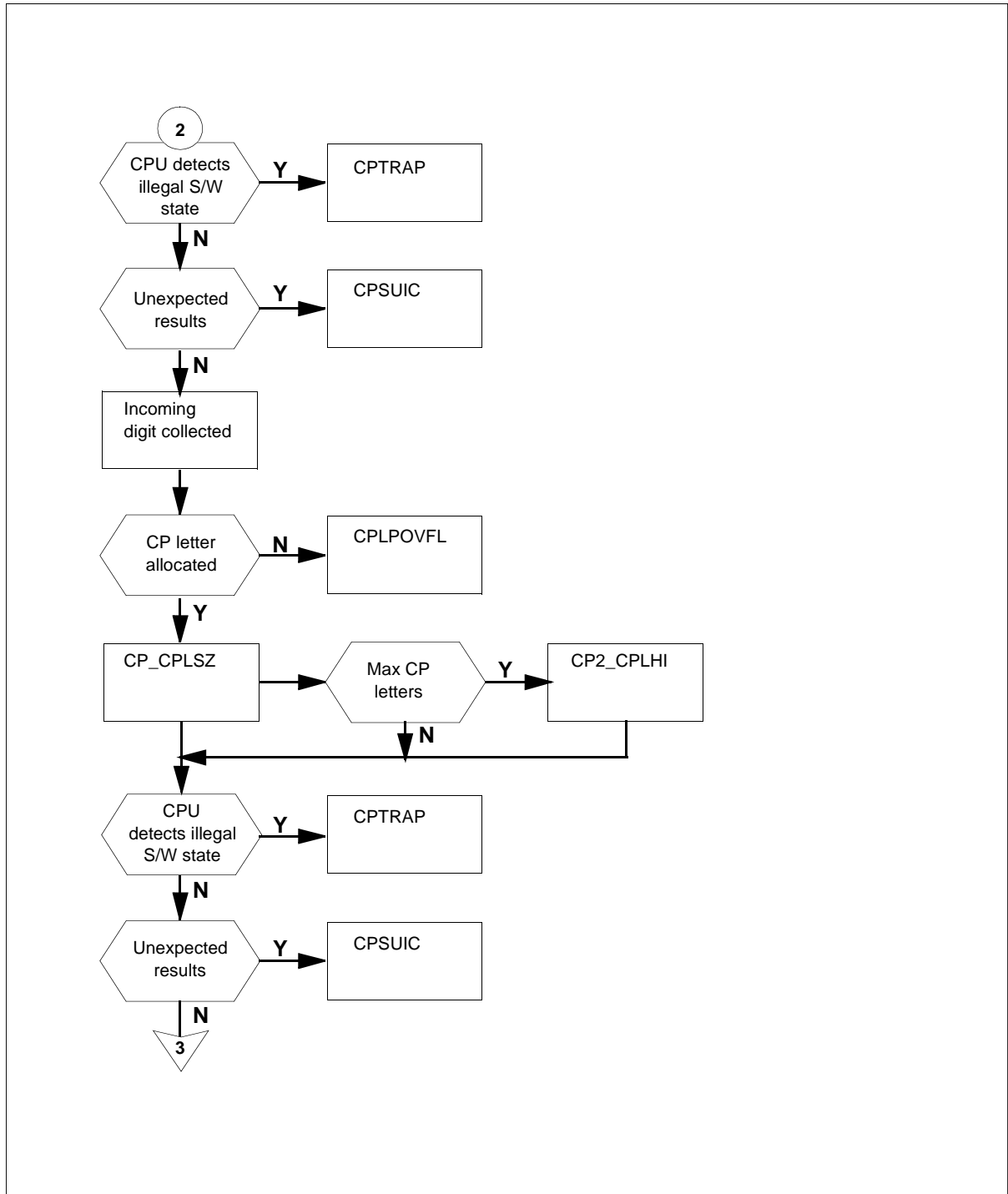
OM group CP (continued)**OM group CP registers (continued)**

OM group CP (continued)

OM group CP registers (continued)

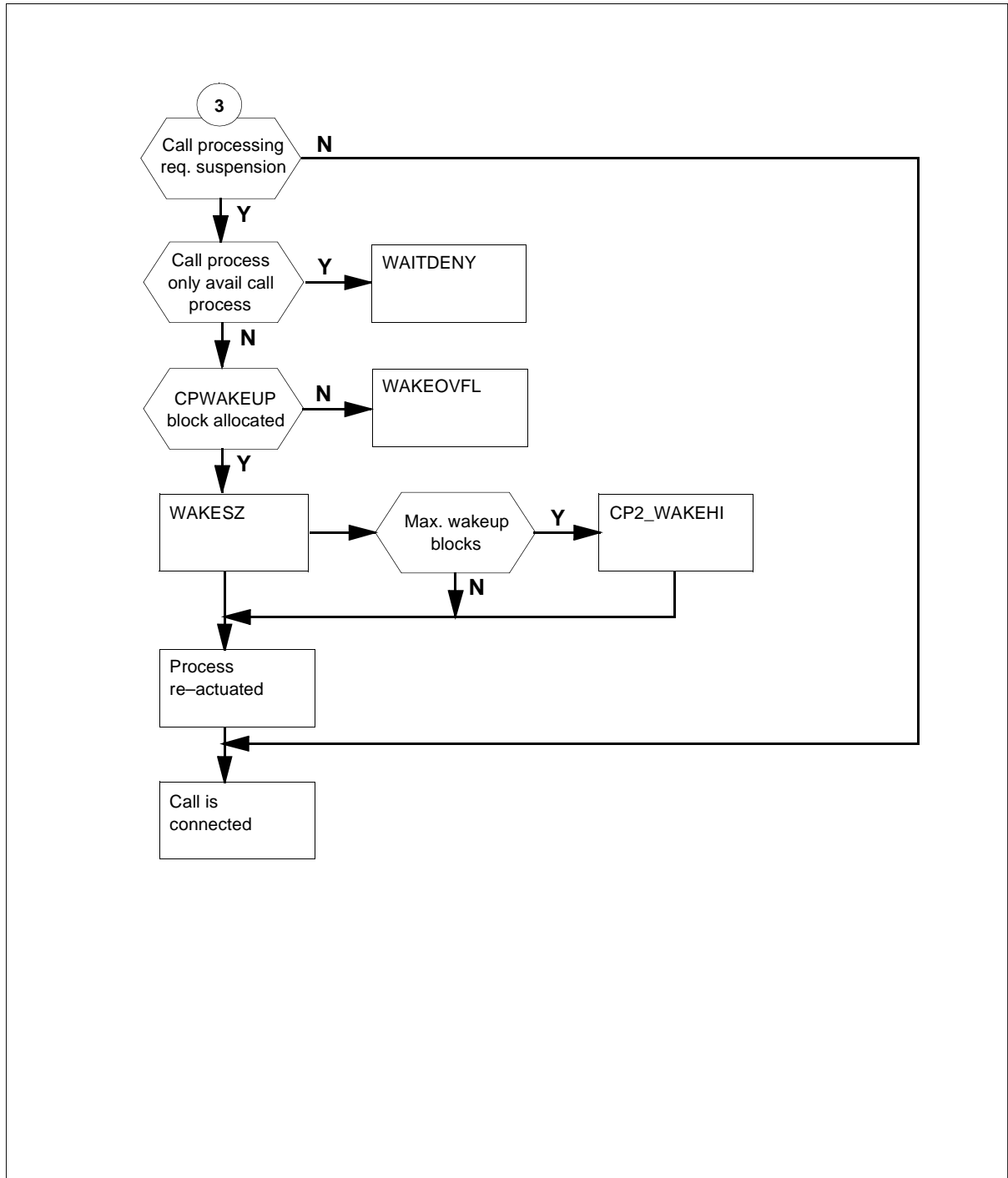

OM group CP (continued)

OM group CP registers: three-way call

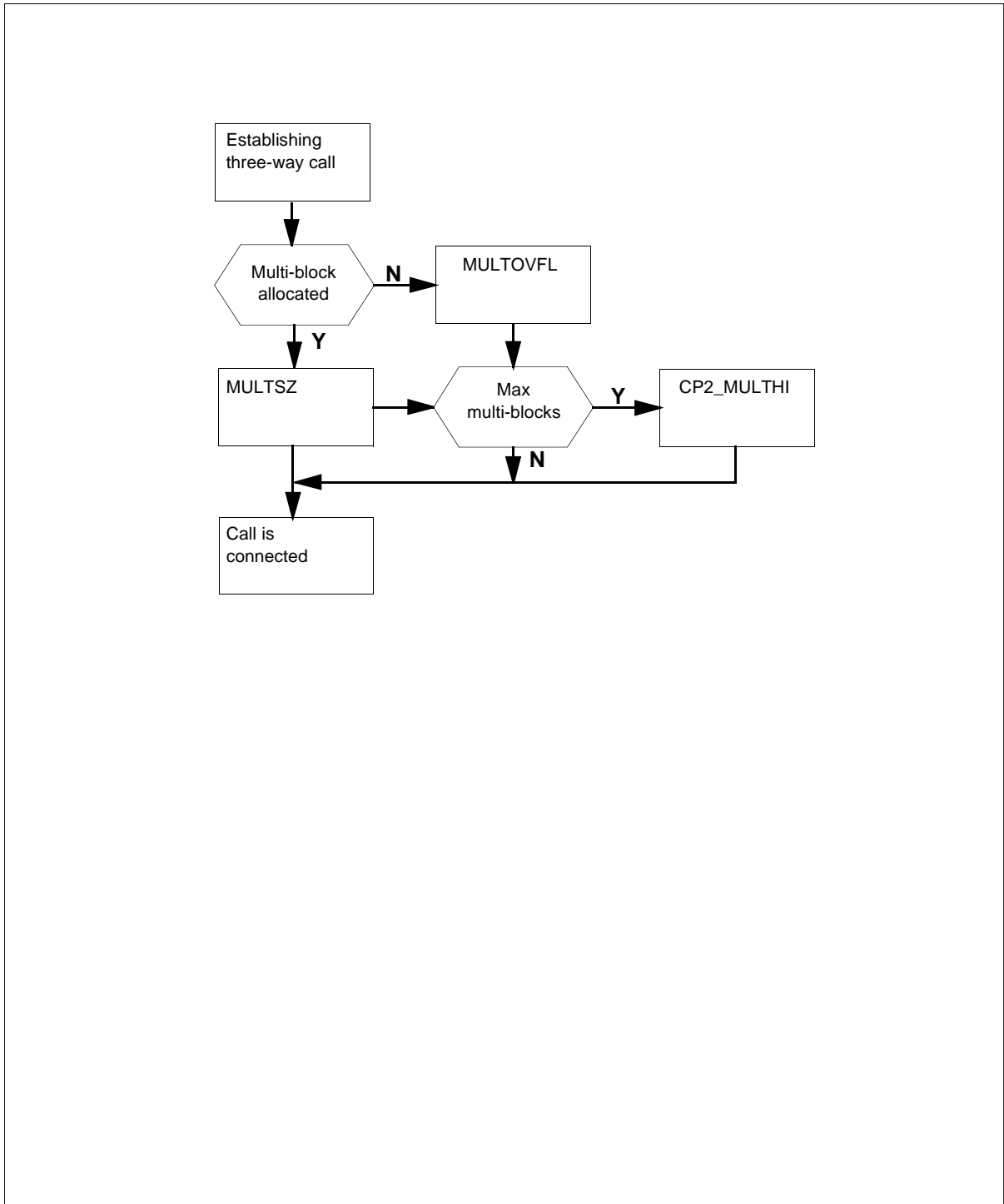

OM group CP (continued)

OM group CP registers: cold and warm restarts

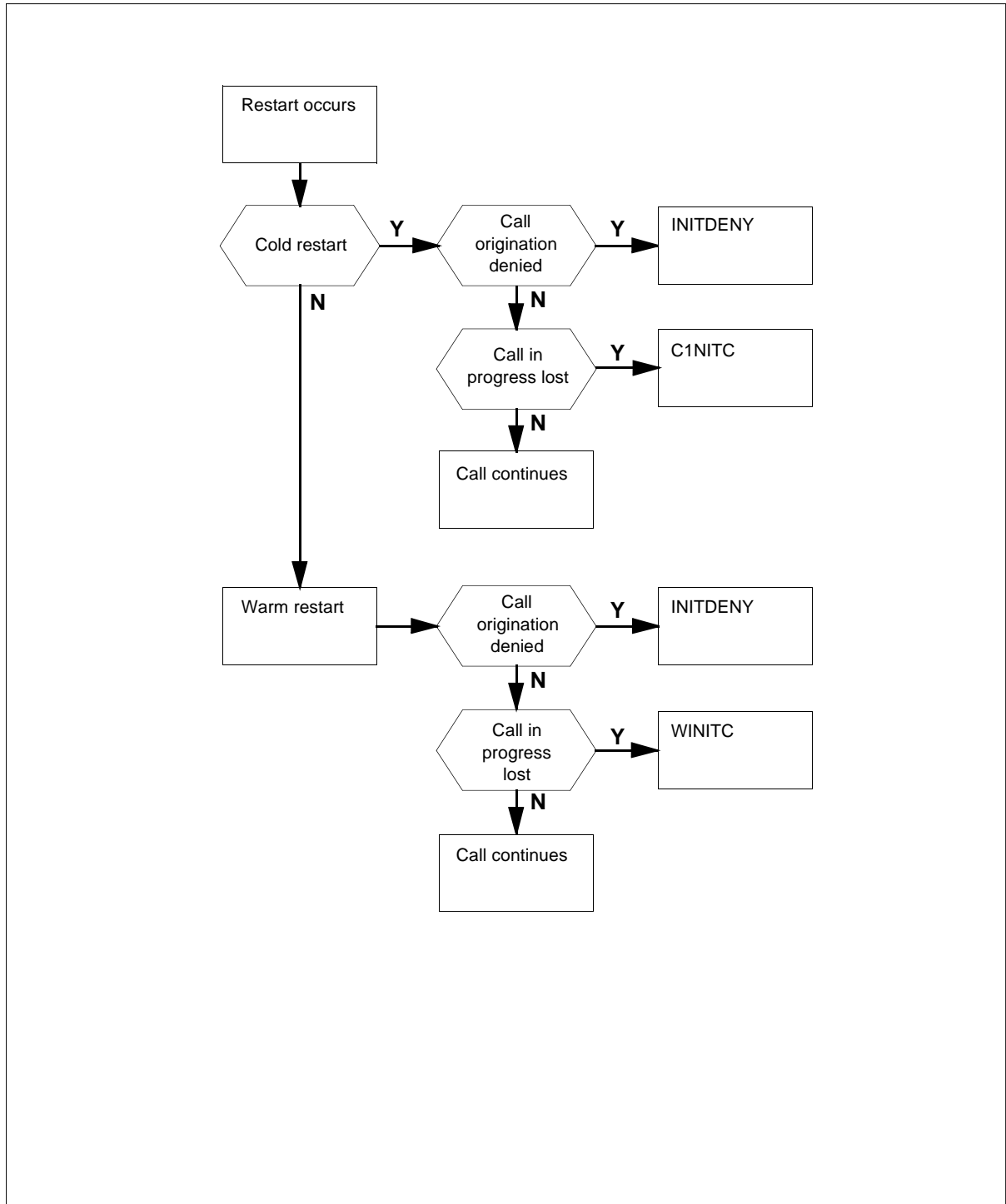

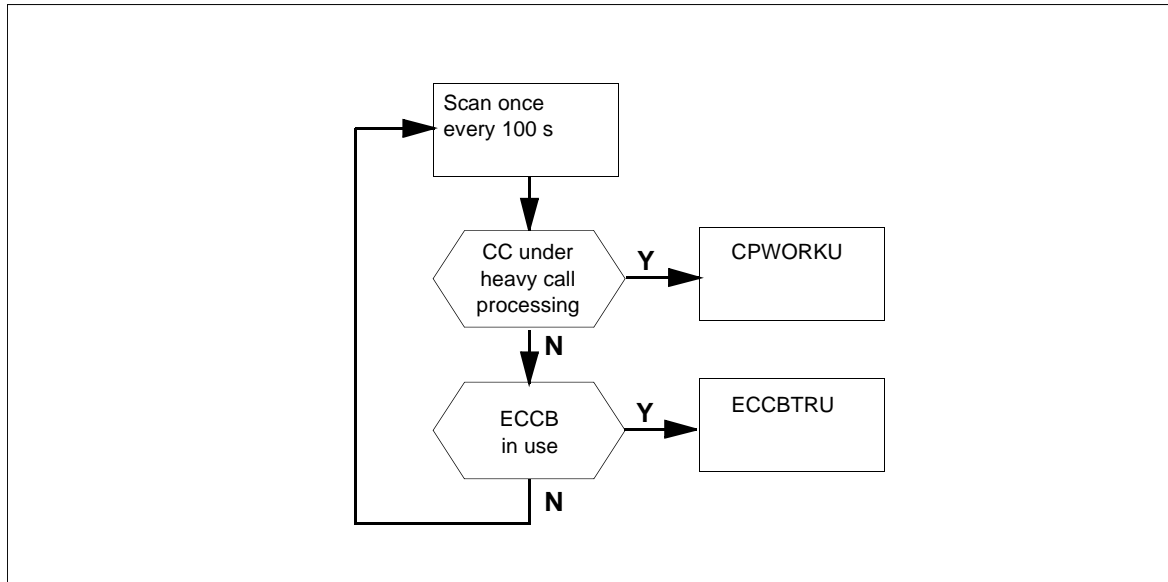
OM group CP (continued)**OM group CP usage registers****Register CCBOVFL**

Call condense block overflow

CCBOVFL counts originating messages that are lost because no idle call condense blocks (CCB) are available to which they can be assigned.

Register CCBOVFL release history

CCBOVFL was introduced prior to BCS20.

Associated registers

None

Associated logs

OM2200 is generated when a threshold defined in tables ALARMTAB and OMTHRESH is exceeded.

Register CCBSZ

Call condense block seizures

CCBSZ is incremented when a call condense block is allocated to an originating call.

Register CCBSZ release history

CCBSZ was introduced prior to BCS20.

OM group CP (continued)

Associated registers

OFZ_NIN counts incoming calls.

OFZ_NORIG counts originating calls.

$CP_CCBSZ = OFZ_NIN + OFZ_NORIG$

Associated logs

None

Extension registers

CCBSZ2

Register CINITC

Calls lost cold restart

CINITC counts call condense blocks that were in use at the time of a cold restart. This count is equal to the number of calls that were in progress and lost because of the cold restart.

Register CINITC release history

CINITC was introduced prior to BCS20.

Associated registers

None

Extension registers

CINITC2

Associated logs

CC107 is generated after a system restart.

INIT is generated when a cold initial program load, reload, or warm restart is performed.

Register CPLBOOVF

Long origination denials

CPLBOOVF counts long originations that were denied to reserve long buffers for long progress messages.

Register CPLBOOVF release history

CPLBOOVF was introduced in BCS26.

OM group CP (continued)

Associated registers

None

Associated logs

None

Register CPLOOVFL

Call processing letters overflow originating calls

CPLOOVFL counts originating messages that could not be passed to call processing using a CP letter because the number of letters available did not exceed the number reserved for calls in progress.

If this register is being pegged, then the CPU is overloaded. The calling capacity has temporarily been exceeded because of a very high busy hour. Parameter ORIDTHRES in table OFCENG needs to be examined.

Register CPLOOVFL release history

CPLOOVFL was introduced prior to BCS20.

Associated registers

None

Associated logs

OM2200 is generated when a threshold defined in tables ALARMTAB and OMTHRESH is exceeded.

Register CPLOSZ

Call processing letters seizures originating calls

CPLOSZ counts origination messages that are successfully attached to a call condense block.

Register CPLOSZ release history

CPLOSZ was introduced prior to BCS20.

Associated registers

None

Extension registers

CLOPSZ2

OM group CP (continued)

Associated logs

None

Register CPLPOVFL

Call processing letters overflow existing calls

CPLPOVFL counts attempts to send a progress message to an existing call that fail because no CP letters are available.

If this register is being pegged, then the CPU is overloaded. The calling capacity has temporarily been exceeded because of a very high busy hour. Parameter ORIDTHRES in table OFCENG needs to be examined.

Register CPLPOVFL release history

CPLPOVFL was introduced prior to BCS20.

Associated registers

None

Associated logs

OM2200 is generated when a threshold defined in tables ALARMTAB and OMTHRESH is exceeded.

Register CPLSZ

Call processing letters seizures existing calls

CPLSZ counts seizures of CP letters that carry messages to calls already in the system.

Register CPLSZ release history

CPLSZ was introduced prior to BCS20.

Associated registers

None

Associated logs

None

Extension registers

CPLSZ2

Register CPSUIC

Call process suicide

OM group CP (continued)

CPSUIC counts calls that fail during call processing because unexpected results were detected during call processing.

Register CPSUIC release history

CPSUIC was introduced prior to BCS20.

Associated registers

None

Associated logs

NET101 is generated when a receiving peripheral detects an integrity mismatch.

SWER is generated when a software condition affecting normal operation of the DMS switch or its peripherals occurs, or when a manual request from the LOGUTIL level of the MAP terminal for a log trace is made.

AUDT100 is generated when an error in a call process is encountered.

AUDT103 is generated when a call process is destroyed.

AUD395 is generated when a call process stops unexpectedly.

AUD398 is generated when a call process stops unexpectedly.

Register CPSZ

Call process seizures

CPSZ is incremented when a call process is activated, which can occur several times during a call.

Register CPSZ release history

CPSZ was introduced prior to BCS20.

Associated registers

None

Associated logs

None

Extension registers

CPSZ2

OM group CP (continued)

Register CPTRAP

Call process trap

CPTRAP counts calls that fail during call processing because the call processing unit hardware detected illegal software conditions.

Only those traps affecting call processing are counted in CPTRAP.

Register CPTRAP release history

CPTRAP was introduced prior to BCS20.

Associated registers

CPU_TRAPINT counts the number of trap interrupts.

CP_CPTRAP £ CPU_TRAPINT

Associated logs

SWER is generated when a software condition affecting normal operation of the DMS switch or its peripherals occurs, or when a manual request from the LOGUTIL level of the MAP display for a log trace is made.

TRAP is generated when an interruption of normal DMS switch operations occurs because of a software or hardware error condition.

AUDT101 is generated when a problem is encountered in the call condense block.

AUDT103 is generated when a call process is destroyed.

AUDT197 is generated when a call is routed to a missing route list.

CC103 is generated when a TRAP occurs.

CC104 is generated when a fault is detected in a central message controller (CMC).

Register INITDENY

Call originations denied, cold and warm restarts

INITDENY counts line and trunk call originations that are lost during cold and warm restarts.

Register INITDENY release history

INITDENY was introduced in BCS20.

OM group CP (continued)

Associated registers

OFZ_NIN counts incoming calls.

OFZ_NORIG counts originating calls.

The values in OFZ_NIN and OFZ_NORIG are converted into a measure of average call origination volume per unit time. This measure multiplied by the duration of the restart is used to increment INITDENY.

Associated logs

CC107 is generated after a system restart.

Register INLBOVFL

Incoming long buffer overflow

INLBOVFL counts requests for a long buffer for an incoming long message that are unsuccessful because there were no free long buffers in the system.

Register INLBOVFL release history

INLBOVFL was introduced in BCS26.

Associated registers

None

Associated logs

OM2200 is generated when a threshold, as defined in tables ALARMTAB and OMTHRESH, is exceeded.

Register INLBSZ

Incoming long buffer seizure

INLBSZ counts successful requests for a long buffer for an incoming long message.

Register INLBSZ release history

INLBSZ was introduced in BCS26.

Associated registers

None

Associated logs

None

OM group CP (continued)

Extension registers

INLBSZ2

Register MULTOVFL

Multiblock overflow

MULTOVFL counts attempts at three-way calling that fail because no idle multiblock is available.

Register MULTOVFL release history

MULTOVFL was introduced prior to BCS20.

Associated registers

None

Associated logs

OM2200 is generated when a threshold, as defined in tables ALARMTAB and OMTHRESH, is exceeded.

Register MULTSZ

Multiblock seizure

MULTSZ counts seizures of a multiblock.

Register MULTSZ release history

MULTSZ was introduced prior to BCS20.

Associated registers

None

Associated logs

None

Register ORIGDENY

Origination denial

ORIGDENY counts originations that are ignored by the CC because they were not serviced within 3 s of arrival.

Register ORIGDENY release history

ORIGDENY was introduced in BCS20.

OM group CP (continued)

GSF031

This register is pegged in the GSF environment.

BCS23

In DMS-100 switch International offices, the ORIGDENY register is incremented when the dial tone queue is full and a dial tone cannot be given to a subscriber.

BCS22

ORIGDENY measures originations ignored by the CC.

BCS20

The incrementing of ORIGDENY implies that a call origination is lost.

Associated registers

None

Associated logs

None

Register OUTBOVFL

Outgoing buffer overflow

OUTBOVFL counts outgoing messages that are lost because no idle outgoing buffer was available.

Register OUTBOVFL release history

OUTBOVFL was introduced prior to BCS20.

Associated registers

None

Associated logs

OM2200 is generated when a threshold, as defined in tables ALARMTAB and OMTHRESH, is exceeded.

Register OUTBSZ

Outgoing buffer seizures

OUTBSZ counts messages going to peripheral modules that are placed in an outgoing buffer because the CMC through which they are routed is busy.

OM group CP (continued)

Register OUTBSZ release history

OUTBSZ was introduced prior to BCS20.

Associated registers

None

Associated logs

None

Register WAITDENEY

Wait denial

WAITDENEY counts calls that are lost because call processing requested a brief suspension and the associated call process was the only one available to process requests for service from other calls. The call is lost.

Register WAITDENEY release history

WAITDENEY was introduced prior to BCS20.

Associated registers

None

Associated logs

None

Register WAKEOVFL

CPWAKEUP block overflow

WAKEOVFL counts unsuccessful CPWAKEUP block seizures.

Register WAKEOVFL release history

WAKEOVFL was introduced prior to BCS20.

Associated registers

None

Associated logs

OM2200 is generated when a threshold condition, as defined in tables ALARMTAB and OMTHRESH, is exceeded.

Register WAKESZ

CPWAKEUP block seizure

WAKESZ counts CPWAKEUP block seizures.

Register WAKESZ release history

WAKESZ was introduced prior to BCS20.

Associated registers

None

Extension registers

WAKESZ2

Associated logs

None

Register WINITC

Calls lost warm restart

WINITC counts calls in progress that were lost because of a warm restart. Following a restart, a short period of time may elapse before the register recognizes how many calls were lost.

Register WINITC release history

WINITC was introduced prior to BCS20.

Associated registers

None

Associated logs

CC107 is generated after a system restart.

INIT is generated when a cold initial program load, reload, or warm restart is performed.

SOS100 is generated when a DUMP command fails.

SWCT103 is generated when a switch of activity (SWACT) step fails to complete successfully.

OM description

Call processing software resources extension (CP2)

The OM group CP2 contains 11 peg registers and two usage registers that extend group CP. The CP2 provides additional information on call processing software resources. This OM group provides information on the use of extended call condense blocks (ECCB). The CP2 contains the high watermark OMs for call processing software resources.

High watermark registers CPLHI, CCBHI, CPHI, OUTBHI, MULTHI, WAKEHI, and INLBHI count the following call processing software resources:

- call processing letters
- call condense blocks
- call processes
- outgoing buffers
- multi-blocks
- wakeup-service blocks
- long buffers

These registers count the preceding software resources if these resources are in use at the same time during the previous OM transfer period. You can use these registers to verify and adjust the engineered quantities of the resources.

All types of DMS switch offices can use CP2.

The scan rate for usage registers is 100 s.

Release history

The OM group CP2 was introduced before BCS20.

GSF031

Register INEFDENY increases in the Generic Services Framework (GSF) environment.

BCS29

Register INEFDENY increases in DMS-250 switch offices by the three-message toss.

OM group CP2 (continued)**BCS26**

Register INLBHI was introduced in BCS26.

BCS25

Register OVRLD was introduced in BCS25.

BCS23

Registers CPLHI, CCBHI, CPHI, OUTBHI, MULTHI, and WAKEHI were introduced in BCS23.

BCS22

Register INEFDENY was introduced in BCS22.

BCS21

Software changes in BCS21 provide use counts in centum call seconds (CCS) or deci-erlangs. Register CPWORKU was introduced in BCS21.

Registers

The OM group CP2 registers appear on the MAP terminal as follows:

ECCBSZ	ECCBOVFL	ECCBTRU	CPWORKU
INEFDENY	CPLHI	CCBHI	CPHI
OUTBHI	MULTHI	WAKEHI	OVRLD
INLBHI			

Group structure

OM group CP2 provides one tuple for each office.

Key field:

There is no key field.

Info field:

There are two information fields. The first field value is 0. The second field is the number of extended callcontrol blocks for the office.

You must make entries in the following three tables: OFCENG, OFCSTD, and OFCVAR.

The office parameter NUMECCBS in table OFCENG defines the number of extended call control blocks.

The office parameter NCCBS in table OFCENG defines the number of call condense blocks.

OM group CP2 (continued)

The office parameter NUMCALLPROCESS in table OFCENG defines the number of call processes.

The office parameter ORIGTHRES in table OFCENG defines the maximum number of CP letters that the system can use to serve originations.

The office parameter NMULTIBLKS in table OFCENG defines the number of multi-blocks.

The office parameter NUMCPWAKE in table OFCENG defines the number of wakeup-service blocks.

The office parameter NUMLONGBUFFERS in table OFCENG defines the number of long buffers.

The office parameter NUMOUTBUFFS in table OFCSTD defines the number of outgoing buffers.

The office parameter CPSTATUS_ON in table OFCVAR indicates if the system must collect CPSTATUS data.

Associated OM groups

The OM group CP records the use of call processing software resources. These resources include call condense blocks, call processes, CP letters, multi-blocks, wakeup-service blocks, and long buffers.

Associated functional groups

There are no associated functional groups.

Associated functionality codes

The associated functionality codes for the OM group CP2 appear in the following table.

Functionality	Code
Common Basic	NTX001AA

OM group CP2 (continued)

OM group CP2 registers

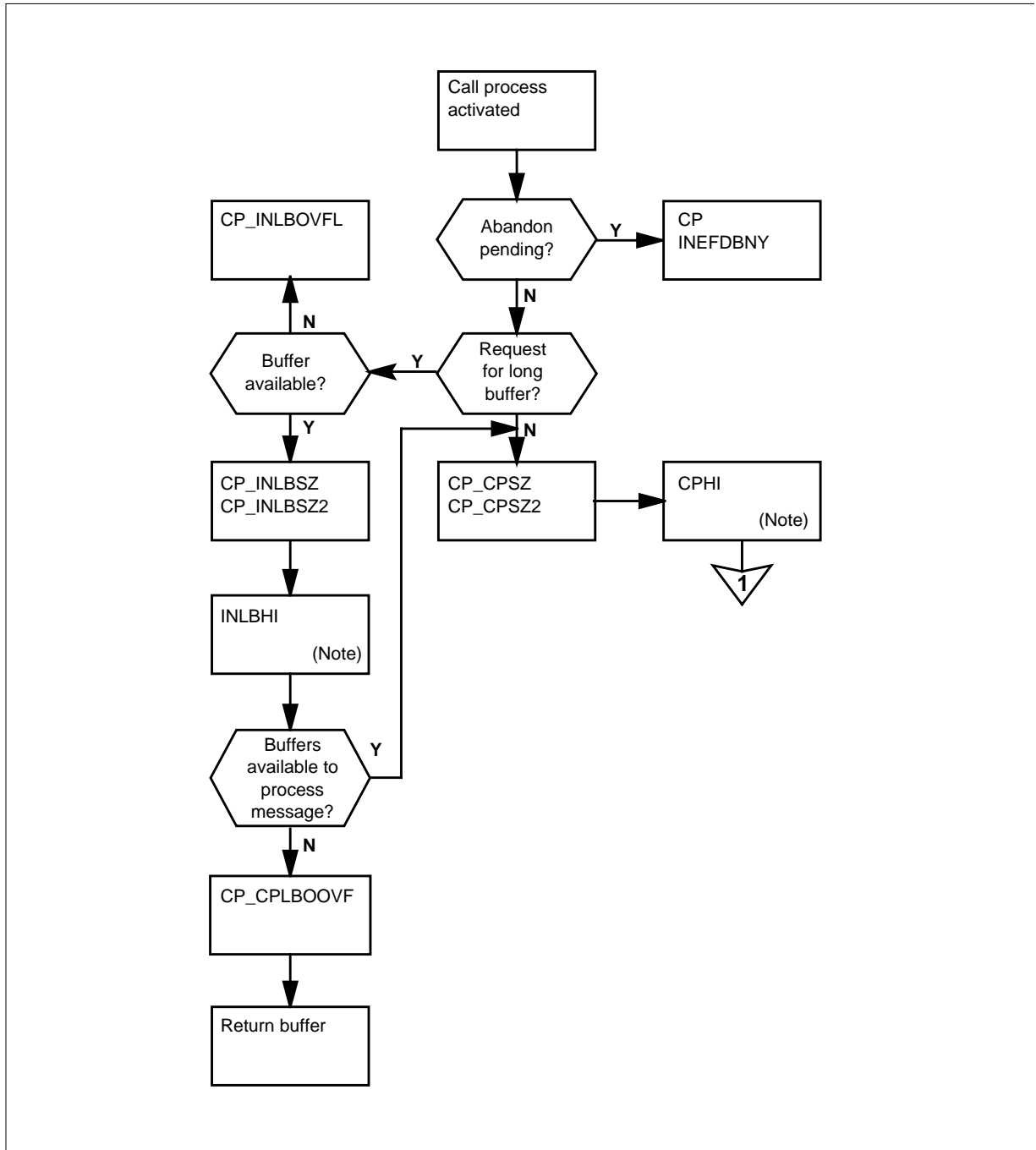

Note: Refer to the figure OM group CP2 registers: high watermarks.

OM group CP2 (continued)

OM group CP2 registers (continued)

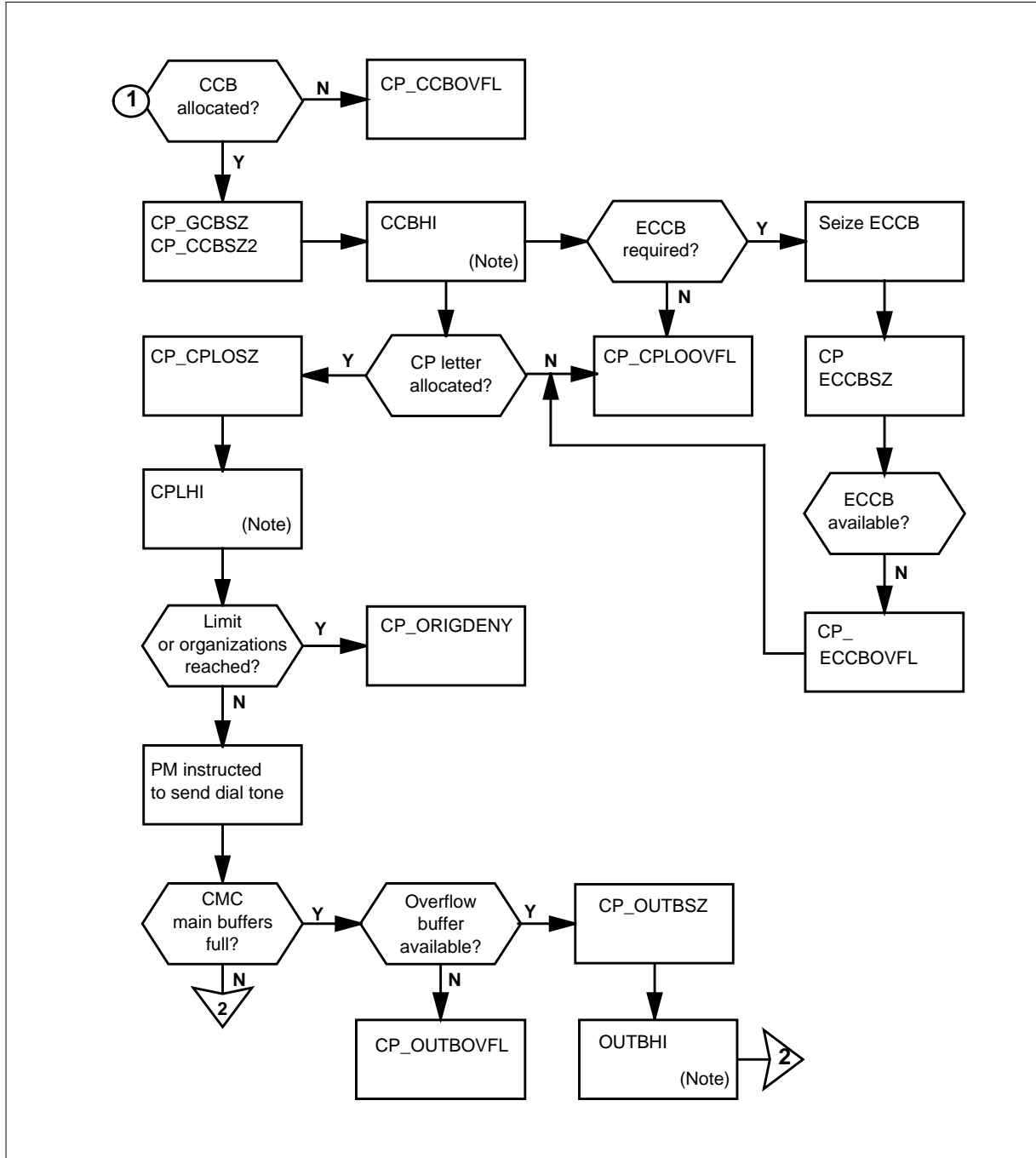

Note: Refer to the figure OM group CP2 registers: high watermarks.

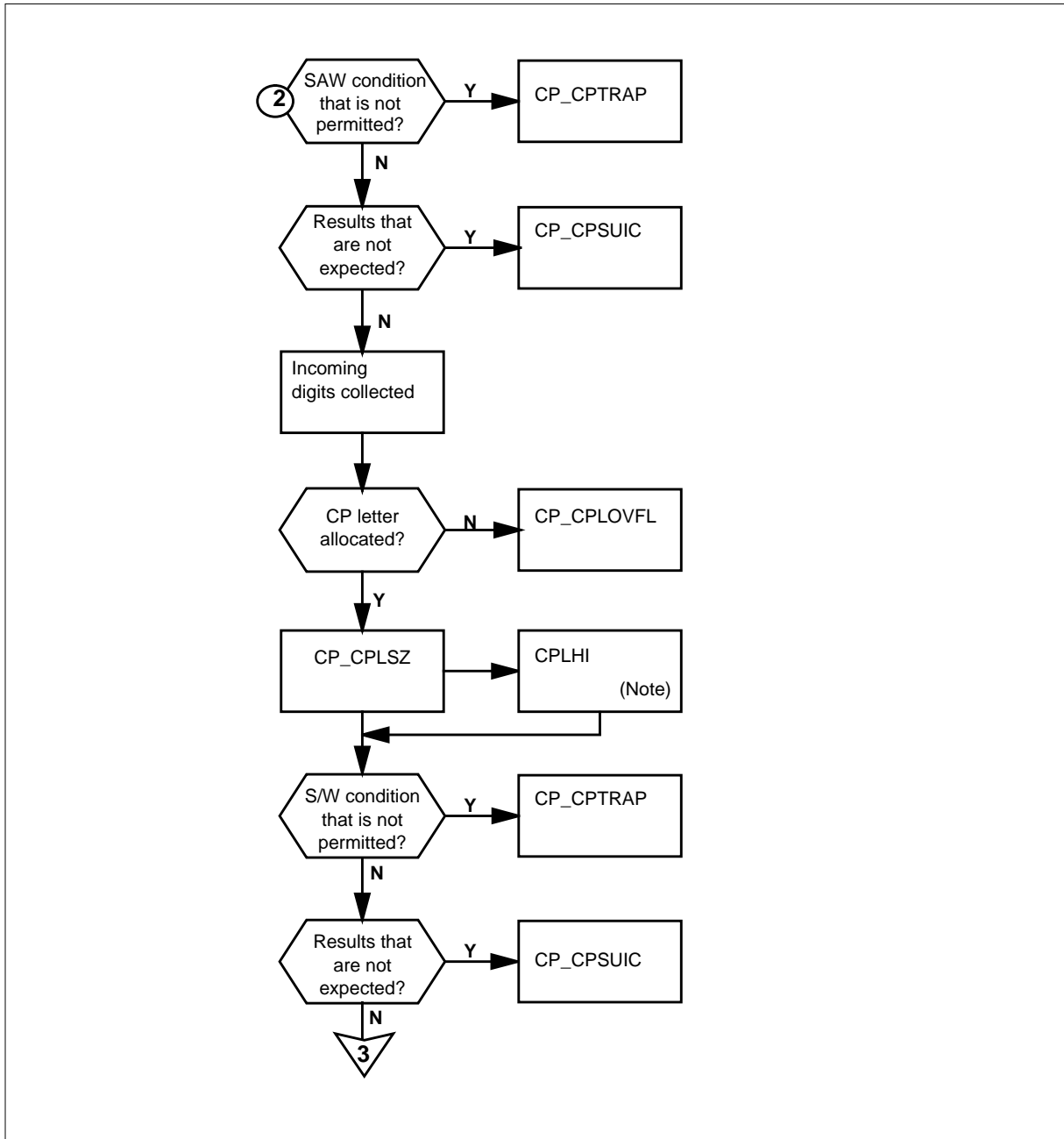
OM group CP2 (continued)**OM group CP2 registers (continued)**

Note: Refer to the figure OM group CP2 registers: high watermarks

OM group CP2 (continued)

OM group CP2 registers (continued)

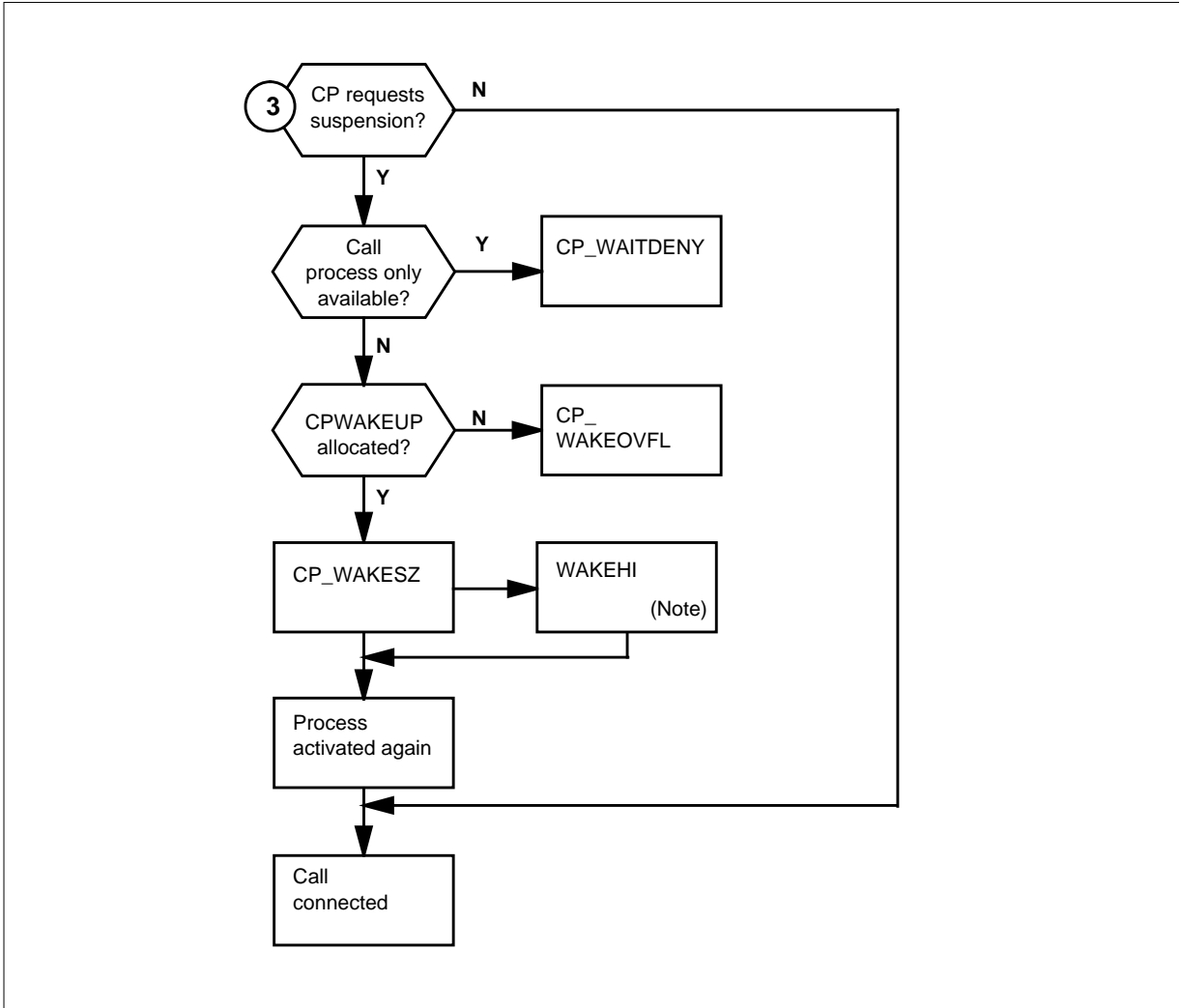

Note: Refer to the figure OM group CP2 registers: high watermarks.

The high watermarks appear in the following flowchart.

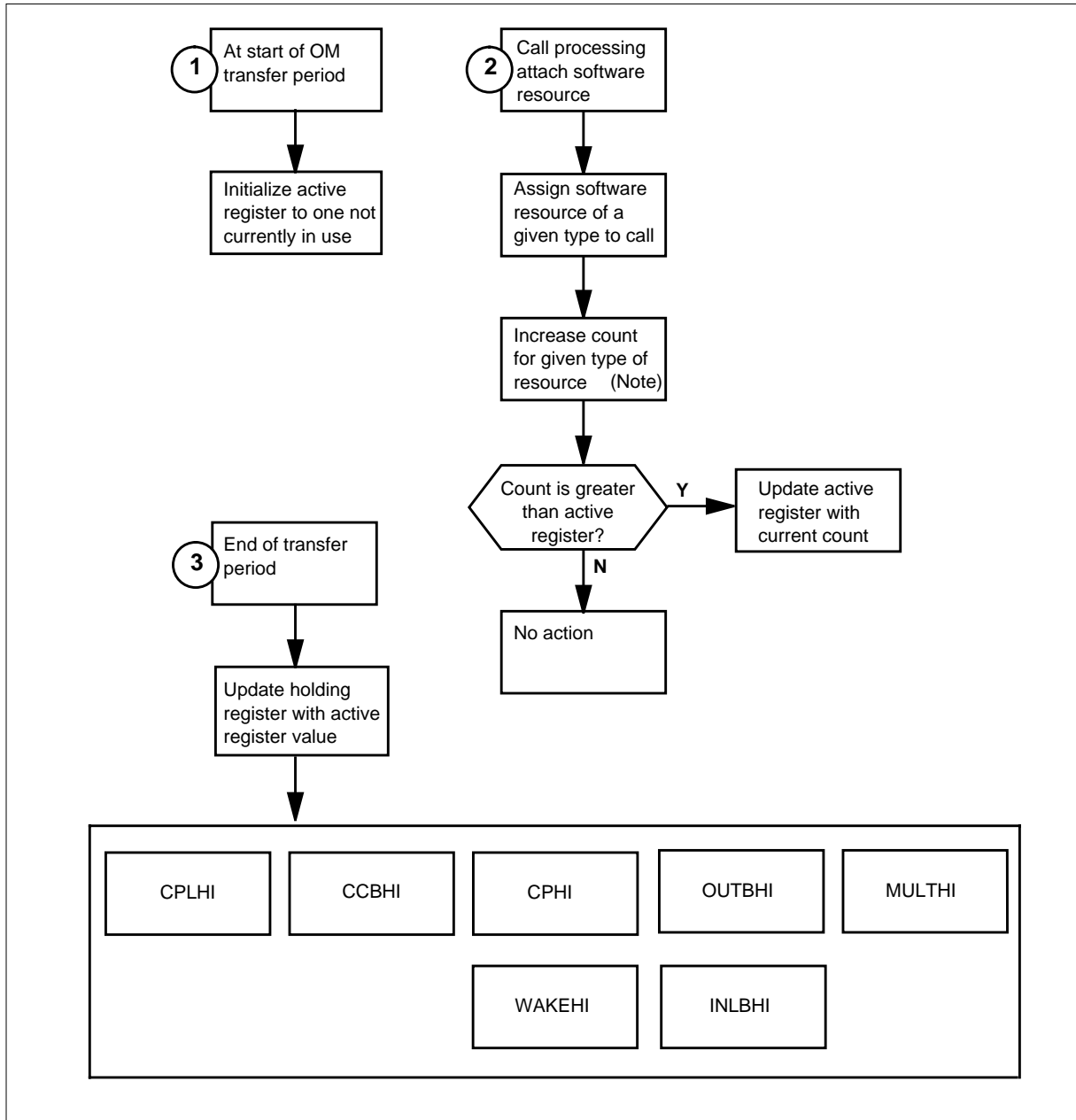
OM group CP2 (continued)**OM group CP2 registers: high watermarks**

Note: The count decreases when a software resource release occurs.

Register CCBHI

Call condense block high watermark (CCBHI)

OM group CP2 (continued)

Register CCBHI reflects the maximum number of CCBs in use at the same time during the previous OM transfer period. This OM transfer period is 15 or 30 min. To predict peak use correctly, you must gather high watermarks for the busiest hours of the busiest days of the year. Follow the High Day Busy Hour or the Extreme Value Engineering method. Use this data to perform calculations and to adjust the number of CCBs. These adjustments make sure that the CCBs are never more than 80% busy during peak use periods.

At the start of each transfer period, the system initializes the active register to the number of CCBs currently in use. The system updates the active register continuously during the transfer period. The system updates this register when the number of blocks currently in use is greater than the value recorded at an earlier period of time.

At the end of the transfer period, the system transfers the active register value to the holding register (CCBHI). The active register value remains in the CCBHI until the system writes a new value. The system writes this value at the end of the next transfer period. The transfer period is 15 or 30 min.

To predict peak use, gather the maximum value of all the high watermarks from each transfer period during the busiest days of the year. Make sure that you add an additional amount to this value so that software resource use during peak periods does not exceed 80%. Enter the calculated value in office parameter NCCBS in table OFCENG.

Register CCBHI release history

Register CCBHI was introduced in BCS23.

Associated registers

There are no associated registers.

Associated logs

There are no associated logs.

Register CPHI

Call processes high watermark (CPHI)

Register CPHI reflects the maximum number of call processes in use at the same time during the previous OM transfer period. The OM transfer period is 15 or 30 min. To predict peak use, correctly gather the high watermarks for the busiest hours of the busiest days of the year. Follow the High Day Busy Hour or the Extreme Value Engineering method. Use this data to perform calculations and to adjust the number of call processes. These adjustments

OM group CP2 (continued)

make sure that the call processes are never more than 80% used during the peak use periods.

At the start of each transfer period, the system initializes the active register to the number of call processes currently in use. The system updates the active register continuously during the transfer period. The system updates the active register when the number of call processes that are currently in use exceeds the previously recorded value.

At the end of the transfer period (15 or 30 min), the active register value is transferred to the holding register (CPHI), where it is retained without change until the system writes a new value. The system writes over a new value at the end of the next transfer period.

To predict correct peak use, take the maximum value of all high watermarks from each transfer period during the busiest days of the year. Calculate an addition to the maximum value to make sure of software resource use is not greater than the target 80% during peak use periods. Enter the calculated value in office parameter NUMCALLPROCESS in table OFCENG.

Register CPHI release history

CPHI was introduced in BCS23.

Associated registers

There are no associated registers.

Associated logs

There are no associated logs.

Register CPLHI

Call processing letters high watermark

Register CPLHI reflects the maximum number of call processing letters in simultaneous use during the previous OM transfer period. The OM transfer period is 15 or 30 min. To predict peak use, gather high watermarks for the busiest hours of the busiest days of the year. Follow the High Day Busy Hour or the Extreme Value Engineering method. Use this data to perform calculations to adjust call processing letters. Adjust the call processing letters to make sure that the letters are never more than 80% busy during peak use periods.

At the start of each transfer period, the system initializes the active register to the number of call processing letters currently in use. The system updates the active register continuously during the transfer period. The system updates the

OM group CP2 (continued)

active register when the number of call processing letters currently in use is greater than the previously recorded value.

At the end of the transfer period, the system transfers the active register value to the holding register (CPLHI). The active value register remains in the CPLHI without change until the system writes over the value. The system writes over the value at the end of the next transfer period.

To predict correct peak use, take the maximum value of all high watermarks from each transfer period during busiest days of year. Add an additional calculated amount to this value. This addition makes sure that the system does not exceed the target 80% use of software resources during peak use periods. Software parameter NUMCPLETTERS sets the calculated amount.

You can use register CPLHI to indicate not enough CP letters.

Register CPLHI release history

CPLHI was introduced in BCS23.

Associated registers

Register CP_CPLPOVFL counts failed attempts to send a progress message to a current call. The attempts fail because idle CP letters are not available. Denial of CP letters to calls in progress can cause serious traffic degradation in the office.

Register CP_CPLOOVFL counts messages that the system cannot pass to call processing through the originating buffers. The buffers associate with peripheral modules in the sequence given. The system cannot pass these messages to call processing with a CP letter. This condition occurs because the number of letters available is not greater than the number reserved for calls in progress.

Associated logs

There are no associated logs.

Register CPWORKU

Call processing use (CPWORKU)

Register CPWORKU is a usage register. The system scans the scheduler in the central control (CC) every 100 s. This register records the scheduler state. Use the count in CPWORKU to measure the amount of time that the CC undergoes heavy call processing.

OM group CP2 (continued)

Register CPWORKU release history

CPWORKU was introduced in BCS21.

Associated registers

There are no associated registers.

Associated logs

There are no associated logs.

Register ECCBOVFL

Extended call control block unsuccessful attempts (ECCBOVFL)

Register ECCBOVFL counts failed requests for an ECCB. The requests fail because the system does not have enough software resources.

Register ECCBOVFL release history

ECCBOVFL was introduced before BCS20.

GL04

The DMS-100G switch does not increment ECCBOVFL.

Associated registers

There are no associated registers.

Associated logs

The system generates LINE138 if the system routes a call to a treatment after the call is call processing busy.

The system generates TRK138 if the system routes a call to a treatment after the call is call processing busy.

Register ECCBSZ

Extended call control blocks successful seizures (ECCBSZ)

Register ECCBSZ counts ECCBs that the system seizes.

Register ECCBSZ release history

ECCBSZ was introduced before BCS20.

Associated registers

There are no associated registers.

OM group CP2 (continued)

Associated logs

There are no associated logs.

Register ECCBTRU

Extended call control block usage (ECCBTRU)

Register ECCBTRU is a usage register. The system scans the ECCBs every 100s and register ECCBTRU records if these blocks are in use.

Register ECCBTRU release history

ECCBTRU was introduced before BCS20.

BCS21

Software changed in BCS21 to provide use counts in CCS or in deci-erlangs.

Associated registers

There are no associated registers.

Associated logs

There are no associated logs.

Register INEFDENY

Ineffective deny (INEFDENY)

Register INEFDENY counts origination and abandon pairs that the central control (CC) ignores. The CC ignores the pairs because the pairs were not serviced in 0.5 s of the time origination arrived in the CC.

In DMS-250 switch offices, three messages associate with a CCB on the start queue. Register INEFDENY increases by the three-message toss. If message 1 is an origination and message 3 is an abandon or clear forward, the system ignores the origination. Register INEFDENY increases. If message 1 is an origination and message 2 is an abandon or clear forward and message 3 is not an origination, the system ignores the origination. Register INEFDENY increases.

Register INEFDENY release history

Register INEFDENY was introduced in BCS22.

GSF031

Register INEFDENY was added to GSF031.

The system pegs this register when two or three message toss overload controls toss messages.

OM group CP2 (continued)

BCS29

Register INEFDENY was added in BCS29 to increase by the three-message toss in DMS-250 switch offices.

Associated registers

There are no associated registers.

Associated logs

There are no associated logs.

Register INLBHI

Long buffer high watermark (INLBHI)

Register INLBHI reflects the maximum number of long buffers in use at the same time during the previous OM transfer period. The OM transfer period is 15 or 30 min. To predict peak usage correctly, gather high watermarks for the busiest hours of the busiest days of the year. Follow the High Day Busy Hour or the Extreme Value Engineering method. Use this data to perform calculations and to adjust the number of CCBs. These adjustments make sure that the CCBs are never more than 80% busy during peak use periods.

At the start of each transfer period, the system initializes the active register to the number of long buffers currently in use. The system updates the active register continuously during the transfer period. The system updates the registers when the number of long buffers currently in use is greater than the previously recorded value.

At the end of the transfer period, the system transfers the active register value to the holding register (INLBHI). The active register value remains in the CCBHI until the system writes a new value at the end of the next transfer period.

To predict peak use, gather the maximum value of all the high watermarks from each transfer period during the busiest days of the year. Make sure that you add an additional amount to this value so that software resource use during peak periods does not exceed 80%. Enter the calculated value in office parameter NUMLONGBUFFERS in table OFCENG.

Register INLBHI release history

Register INLBHI was introduced in BCS26.

Associated registers

There are no associated registers.

OM group CP2 (continued)

Associated logs

There are no associated logs.

Register MULTHI

Multiblock high watermark (MULTHI)

Register MULTHI reflects the maximum number of multi-blocks in use at the same time during the previous OM transfer period. This OM transfer period is 15 or 30 min. To predict peak use correctly, you must gather high watermarks for the busiest hours of the busiest days of the year. Follow the High Day Busy Hour or the Extreme Value Engineering method. Use this data to perform calculations and to adjust the number of multi-blocks. These adjustments make sure that the multi-blocks are never more than 80% busy during peak use periods.

At the start of each transfer period, the system initializes the active register to the number of multi-blocks currently in use. The system updates the active register continuously during the transfer period. The system updates this register when the number of multi-blocks currently in use is greater than the value recorded at an earlier period of time

At the end of the transfer period, the system transfers the active register value to the holding register (MULTHI). The active register value remains in the MULTHI until the system writes a new value. The system writes this value at the end of the next transfer period. The transfer period is 15 or 30 min.

To predict peak use, gather the maximum value of all the high watermarks from each transfer period during the busiest days of the year. Make sure that you add an additional amount to this value so that software resource use during peak periods does not exceed 80%. Enter the calculated in office parameter NMULTIBLKS in table OFCENG.

Register MULTHI was introduced in BCS23.

Associated registers

There are no associated registers.

Associated logs

There are no associated logs.

Register OUTBHI

Outgoing buffer high watermark (OUTBHI)

OM group CP2 (continued)

Register OUTBHI reflects the maximum number of outgoing buffers in use at the same time during the previous OM transfer period. This OM transfer period is 15 or 30 min. To predict peak use correctly, you must gather high watermarks for the busiest hours of the busiest days of the year. Follow the High Day Busy Hour or the Extreme Value Engineering method. Use this data to perform calculations and to adjust the number of outgoing buffers. These adjustments make sure that the multi-blocks are never more than 80% busy during peak use periods.

At the start of each transfer period, the system initializes the active register to the number of outgoing buffers currently in use. The system updates the active register continuously during the transfer period. The system updates this register when the number of outgoing buffers currently in use is greater than the value recorded at an earlier period of time

At the end of the transfer period, the system transfers the active register value to the holding register (OUTBHI). The active register value remains in the OUTBHU until the system writes a new value. The system writes this value at the end of the next transfer period. The transfer period is 15 or 30 min.

To predict peak use, gather the maximum value of all the high watermarks from each transfer period during the busiest days of the year. Make sure that you add an additional amount to this value so that software resource use during peak periods does not exceed 80%. Enter the calculated value in office parameter NUMOUTBUFFS in table OFCENG.

High use of outgoing buffers can cause central message controller (CMC) congestion or out-of-service states.

Register OUTBHI release history

Register OUTBHI was introduced in BCS23.

Associated registers

There are no associated registers.

Associated logs

There are no associated logs.

Register OVRLD

Central control overload (OVRLD)

Register OVRLD counts the number of minutes during which CC overload controls were active during the last OM transfer period. If the OVRLD field is set to on, this register increases every minute by CPSTATUS. You set the

OM group CP2 (continued)

OVRLD field to on at the CPSTATUS display at the MAP terminal or on the CPSTAT output.

Register OVRLD release history

Register OVRLD was introduced in BCS25.

Associated registers

There are no associated registers.

Associated logs

There are no associated logs.

Register WAKEHI

Wakeup block high watermark (WAKEHI)

Register WAKEHI reflects the maximum number of wakeup-service blocks in use at the same time during the previous OM transfer period. This OM transfer period is 15 or 30 min. To predict peak use correctly, you must gather high watermarks for the busiest hours of the busiest days of the year. Follow the High Day Busy Hour or the Extreme Value Engineering method. Use this data to perform calculations and to adjust the number of outgoing buffers. These adjustments make sure that the multi-blocks are never more than 80% busy during peak use periods.

At the start of each transfer period, the system initializes the active register to the number of wakeup-service blocks currently in use. The system updates the active register continuously during the transfer period. The system updates this register when the number of wakeup-service blocks currently in use is greater than the value previously recorded.

At the end of the transfer period, the system transfers the active register value to the holding register (WAKEHI). The active register value remains in the WAKEHI until the system writes a new value. The system writes this value at the end of the next transfer period. The transfer period is 15 or 30 min.

To predict peak use, gather the maximum value of all the high watermarks from each transfer period during the busiest days of the year. Make sure that you add an additional amount to this value so that software resource use during peak periods does not exceed 80%. Enter the calculated value in office parameter NUMCPWAKE in table OFCENG.

Register WAKEHI release history

Register WAKEHI was introduced in BCS23.

OM group CP2 (end)

Associated registers

There are no associated registers.

Associated logs

There are no associated logs.

OM group CPUSTAT

OM description

Central processing unit status (CPUSTAT)

The OM group CPUSTAT provides information on CPU occupancy. The CPU occupancy is the percentage of total CPU time that the CPU spends on one function. CPUSTAT shows the CPU percentage assigned to the scheduler and the percentage available for call processing at capacity. You can use this OM group to check capacity.

The support operating system (SOS) scheduler uses scheduler classes to allocate CPU time processes that occur at the same time. A scheduler class is a group of processes that perform like or related functions. CPUSTAT measures the CPU use of processes that runs in each scheduler class for all types of CPUs. The OM group CPUSTAT does not measure for the Bell-Northern Research reduced instruction set computer (BRISC) SuperNode core.

The OM group CPUSTAT registers count the following CPU occupancies:

- call processing
- call processing occupancy available
- scheduler
- system operations
- critical system maintenance
- Network Operating System (NOS) file transfer
- operational measurements
- guaranteed terminals
- processes that are not guaranteed and that you can delay
- idler
- auxiliary call processing
- network maintenance

Use the data supplied by CPUSTAT to calculate the average work time and the switch capacity for office equipment and engineering.

Release history

The OM group CPUSTAT was introduced in BCS25

OM group CPUSTAT (continued)

BCS36

Register CPSSNIP was introduced in BCS36.

BCS34

Register CPSNETM was introduced in BCS34.

BCS31

Register CPSAUXCP was introduced in BCS31.

Registers

The OM group CPUSTAT registers appear on the MAP terminal as follows:

CPSCPOCC	CCPAVAIL	CPSSCHED	CPSFORE
CPSMAINT	CPSDNC	CPSOM	CPSGTERM
CPSBKG	CPSIDLE	CPSAUXCP	CPSNETM
CPSSNIP			

Group structure

The OM group CPUSTAT provides one tuple for each office.

Key field:

There is no Key field

Info field:

There is no Info field

Parameter CC_ENGLEVEL_WARNING_THRESHOLD in table OFCENG defines the engineered occupancy level of the switch.

Parameter AUXCP_CPU_SHARE in table OFCENG shows the percentage of CPU time allocated for the auxiliary call processing scheduler class.

Parameter GUARANTEED_TERMINAL_CPU_SHARE in table OFCENG indicates the percentage of CPU time allocated for the guaranteed terminal scheduler class.

Associated OM groups

The OM group APOCCS measures CPU use for processes that run on an application processor.

The OM group BRSTAT provides information on CPU use for SuperNode offices that use the Bell-Northern Research reduced instruction set computer (BRISC).

OM group CPUSTAT (continued)

The OM group BSCPU measures CPU use for processes that run on a Billing Server.

The OM group CP provides information on the use of call condense blocks (CCBs).

The OM group CP2 provides information on the use of extended call condense blocks (ECCBs).

The OM group ENETOCC measures CPU use for processes that run on the enhanced network (ENET).

The OM group NCMCPUST measures CPU use for processes that run on non-CM SOS-based nodes.

Associated operational groups

The following operational groups associate with OM group CPUSTAT:

- DMS-100 Local
- DMS-100/200
- DMS-100/200 TOPS
- DMS-200
- DMS-200 TOPS
- DMS-100 Meridian
- DMS-MTX
- DMS-250
- DMS-300
- Meridian SL-100 PBX
- DMS-SuperNode

Associated functionality codes

The following table shows functionality codes associated with OM group CPUSTAT.

Functionality	Code
Enhanced Real Time Indicator	NTX291AA
ISDN Base Access	NTX750AA

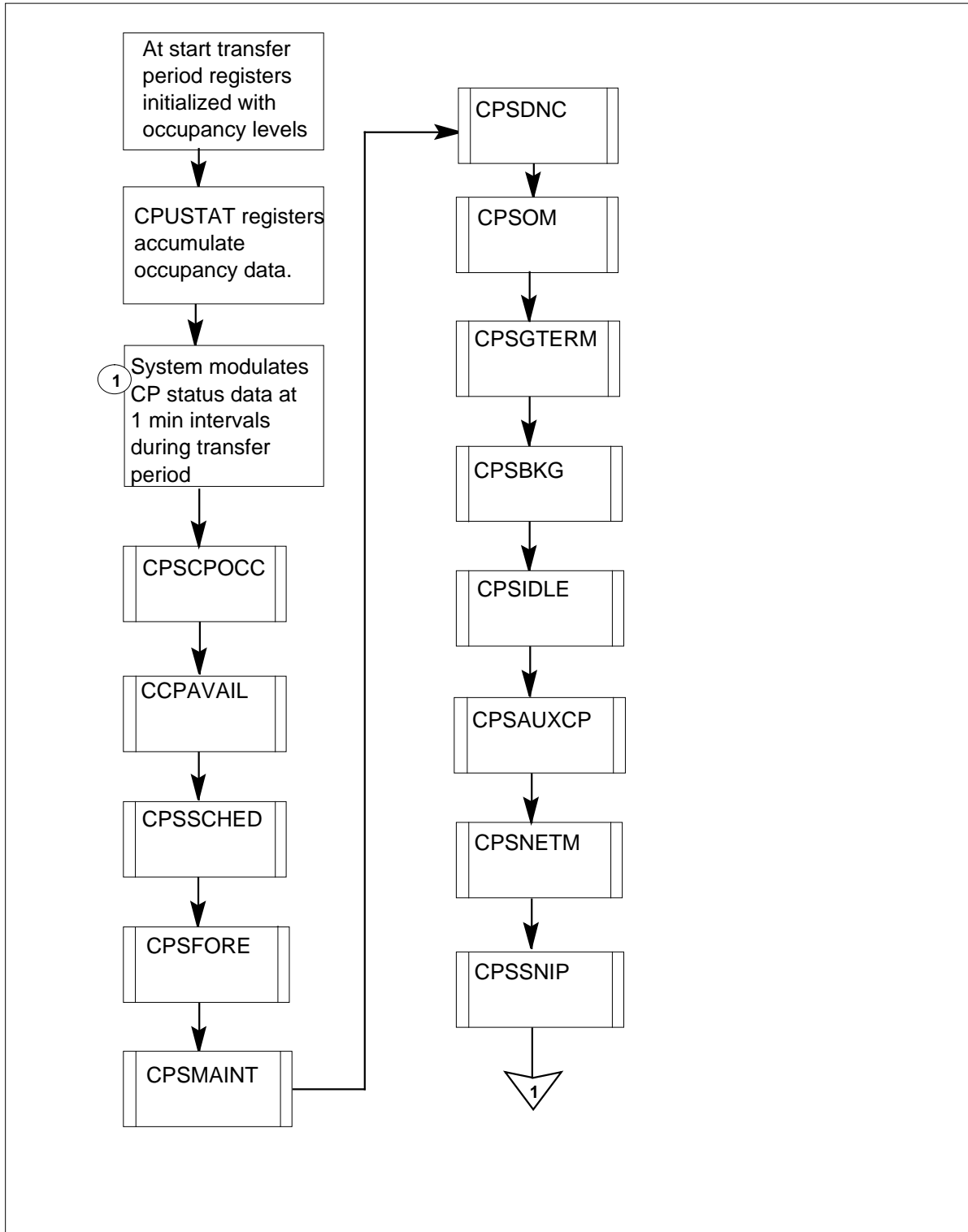
OM group CPUSTAT (continued)**OM group CPUSTAT registers**

OM group CPUSTAT (continued)

Register CCPAVAIL

CPU call processing available occupancy (CCPAVAIL)

Register CCPAVAIL accumulates the CPU call processing available occupancies and displays this amount as an integer. Each of these occupancies is the percentage of CPU time that available for call processing in a given time sample. This occupancy is the difference between maximum CPU time available for call processing and the percentage of CPU time in use in a given time sample.

At the beginning of the transfer period, the system initializes CCPAVAIL to the current value of the CPU call processing available occupancy. The system updates the occupancy values from CPSTATUS data at 1 min intervals during the transfer period. Each time the occupancy increases, register CCPAVAIL accumulates the value.

To obtain the average CPU call processing available occupancy for one min, divide the holding register value by the transfer period. Measure the transfer period in minutes.

Register CCPAVAIL release history

Register CCPAVAIL was introduced in BCS25.

Associated registers

There are no associated registers.

Associated logs

There are no associated logs.

Register CPSAUXCP

CPU status auxiliary call processing occupancy (CPSAUXCP)

Register CPSAUXCP accumulates the CPU auxiliary call processing occupancies and displays this amount as an integer. Each of these occupancies is the percentage of CPU time spent on the simplified-message desk interface (SMDI) incoming message handler processes. The system measures these occupancies in a given time sample. These processes are the processes in the auxiliary call processing scheduler class.

At the beginning of the transfer period, the system initializes CPSAUXCP to the current value of the CPU auxiliary call processing occupancy. The system updates the occupancy values from CPSTATUS data at 1 min intervals during the transfer period. Each time, the occupancy increases and the register CPSAUXCP accumulates the value.

OM group CPUSTAT (continued)

To obtain the average CPU auxiliary call processing occupancy for 1 min, divide the holding register value by the transfer period. Measure the transfer period in minutes.

Office parameter AUXCP_CPU_SHARE in table OFCENG indicates percentage of CPU time allocated for the auxiliary call processing scheduler class.

Register CPSAUXCP release history

Register CPSAUXCP was introduced in BCS31.

Associated registers

There are no associated registers.

Associated logs

There are no associated logs.

Register CPSBKG

CPU status background occupancy (CPSBKG)

Register CPSBKG accumulates the CPU background occupancies and displays this amount as an integer. Each of these occupancies is the percentage of CPU time spent on processes related to:

- the log system,
- audits
- non-critical system maintenance
- non-guaranteed MAP
- operational measurements

The system measures those occupancies in a given time sample.

At the beginning of the transfer period, the system initializes register CPSBKG to the current value of the CPU background occupancy. The system updates the occupancy values from CPSTATUS data at 1 min intervals during the transfer period. Each time the occupancy increases, register CPSBKG accumulates the value.

To obtain the average CPU background occupancy for 1 min, divide the holding register value by the transfer period. Measure the transfer period in minutes.

OM group CPUSTAT (continued)

Register CPSBKG release history

Register CPSBKG was introduced in BCS25.

Associated registers

There are no associated registers.

Associated logs

There are no associated logs.

Register CPSCPOCC

CPU status call processing occupancy (CPSCPOCC)

Register CPSCPOCC accumulates the CPU call processing occupancies and displays this amount as an integer. Each of these occupancies is the percentage of CPU time spent on call processing-related processes in a given time sample. These processes are processes in the following scheduler classes:

- high-priority call processing
- normal call processing
- deferrable call processing

At the beginning of the transfer period, the system initializes CPSCPOCC to the current value of the CPU call processing occupancy. The system updates the occupancy values from CPSTATUS data at 1 min intervals during the transfer period. Each time the occupancy increases, register CPSCPOCC accumulates the value.

To obtain the average CPU call processing occupancy for 1 min, divide the holding register value by the transfer period. Measure the transfer period in minutes.

Register CPSCPOCC release history

Register CPSCPOCC was introduced in BCS25.

Associated registers

There are no associated registers.

Associated logs

There are no associated logs.

Register CPSDNC

CPU status dynamic network controller occupancy (CPSDNC)

OM group CPUSTAT (continued)

Register CPSDNC accumulates the CPU dynamic network controller (DNC) occupancies and displays this amount as an integer. Each of these occupancies is percentage of CPU time spent on Network Operations System (NOS) processes that communicate with a DNC. The system measures the occupancies in a given sample. These are the processes in the NOS file transfer scheduler classes.

At the beginning of the transfer period, the system initializes CPSDNC to the current value of the CPU DNC occupancy. The system updates occupancy values from CPSTATUS data at 1 min intervals during the transfer period. Each time the occupancy increases register CPSDNC accumulates the value.

To obtain the average CPU DNC occupancy for 1 min, divide the holding register value by the transfer period. Measure the transfer period in minutes.

Register CPSDNC release history

Register CPSDNC was introduced in BCS25.

Associated registers

There are no associated registers.

Associated logs

There are no associated logs.

Register CPSFORE

CPU status front occupancy (CPSFORE)

Register CPSFORE accumulates the CPU front occupancies displays this amount as an integer. Each of these occupancies is the percentage of CPU time spent on system operations-related processes in a given time sample. These processes are processes in the system and system tools scheduler classes. These scheduler classes were earlier known as system7 and system6, in the sequence given.

At the beginning of the transfer period, the system initializes CPSFORE to the current value of the CPU front occupancy. The system updates the occupancy values from CPSTATUS data at 1 min intervals during the transfer period. Each time the occupancy increases, register CPSFORE accumulates the value.

To obtain the average CPU front occupancy for 1 min, divide the holding register value by the transfer period. Measure the transfer period in minutes.

Register CPSFORE release history

Register CPSFORE was introduced in BCS25.

OM group CPUSTAT (continued)

Associated registers

There are no associated registers.

Associated logs

There are no associated logs.

Register CPSGTERM

CPU status guaranteed terminal occupancy (CPSGTERM)

Register CPSGTERM accumulates the CPU guaranteed terminal occupancies and displays this amount as an integer. Each of these occupancies is percentage of CPU time spent on guaranteed MAP terminals, guaranteed log devices, and the login process. The system measures those occupancies in a given time sample. These are processes in the guaranteed terminal scheduler class, earlier known as guaranteed background. Guaranteed terminal occupancy is at the cost of call processing.

At the beginning of the transfer period, the system initializes CPSGTERM to the current value of the CPU guaranteed terminal occupancy. The system indicates the occupancy values from CPSTATUS data at 1 min intervals during the transfer period. Each time the occupancy increases, register CPSGTERM accumulates the value.

To obtain the average CPU guaranteed terminal occupancy for 1 min, divide the holding register value by the transfer period. Measure the transfer period in minutes.

Office parameter GUARANTEED_TERMINAL_CPU_SHARE in table OFCENG indicates percentage of CPU time allocated for the guaranteed terminal scheduler class.

Register CPSGTERM release history

Register CPSGTERM was introduced in BCS25.

Associated registers

There are no associated registers.

Associated logs

There are no associated logs.

Register CPSIDLE

CPU status idler occupancy (CPSIDLE)

OM group CPUSTAT (continued)

Register CPSIDLE accumulates the CPU idler occupancies and displays this amount as an integer. Each of these occupancies is the percentage of CPU time spent on the idler process, memory checksums, and call processing audits. The system measures these occupancies in a given time sample. These are processes in the idler scheduler class, earlier known as system 0.

At the beginning of the transfer period, the system initializes CPSIDLE to the current value of the CPU idler occupancy. The system updates the occupancy values from CPSTATUS data at 1 min intervals during the transfer period. Each time the occupancy increases, register CPSIDLE accumulates the value.

To obtain the average CPU idler occupancy for 1 min, divide the holding register value by the transfer period. Measure the transfer period in minutes.

Register CPSIDLE release history

Register CPSIDLE was introduced in BCS25.

Associated registers

There are no associated registers.

Associated logs

There are no associated logs.

Register CPSMAINT

CPU status maintenance occupancy (CPSMAINT)

Register CPSMAINT accumulates the CPU maintenance occupancies and displays this amount as an integer. Each of these occupancies is the percentage of CPU time spent on critical system maintenance processes in a given one time sample. These are processes in the maintenance scheduler class.

At the beginning of the transfer period, the system initializes CPSMAINT to the current value of the CPU maintenance occupancy. The system updates occupancy values from CPSTATUS data at 1 min intervals during the transfer period. Each time the occupancy increases, register CPSMAINT accumulates the value.

To obtain the average CPU maintenance occupancy for 1 min, divide the holding register value by the transfer period. Measure the transfer period in minutes.

Register CPSMAINT release history

Register CPSMAINT was introduced in BCS25.

OM group CPUSTAT (continued)

Associated registers

There are no associated registers.

Associated logs

There are no associated logs.

Register CPSNETM

CPU status network maintenance class (CPSNETM)

Register CPSNETM accumulates the CPU network maintenance occupancies and displays this amount as an integer. Each of these occupancies is the percentage of CPU time spent on network maintenance processes in a given time sample. These are processes in the network maintenance scheduler class.

At the beginning of the transfer period, the system initializes CPSNETM to the current value of the CPU network maintenance occupancy. The system updates occupancy values from CPSTATUS data at 1 min intervals during the transfer period. Each time the occupancy increases, register CPSNETM accumulates the value.

To obtain the average CPU network maintenance occupancy for 1 min, divide the holding register value by the transfer period. Measure the transfer period in minutes.

Register CPSNETM release history

Register CPSNETM was introduced in BCS34.

Associated registers

There are no associated registers.

Associated logs

There are no associated logs.

Register CPSOM

CPU status operational measurements occupancy (CPSOM)

Register CPSOM accumulates the CPU operational measurements (OM) occupancies and amount as an integer. Each of these occupancies is the percentage of CPU time spent on OM processes in a given time sample. These are processes in the guaranteed and not guaranteed OM scheduler classes.

At the beginning of the transfer period, the system initializes CPSOM to the current value of the CPU OM occupancy. The system updates the occupancy

OM group CPUSTAT (continued)

value from CPSTATUS data at 1 min intervals during the transfer period. Each time the occupancy increases, register CPSOM accumulates the value.

To obtain the average CPU OM occupancy for 1 min, divide the holding register value by the transfer period. Measure the transfer period in minutes.

Register CPSOM release history

Register CPSOM was introduced in BCS25.

Associated registers

There are no associated registers.

Associated logs

There are no associated logs.

Register CPSSCHED

CPU status scheduler occupancy (CPSSCHED)

Register CPSSCHED accumulates the CPU scheduler occupancies and displays this amount as an integer. Each of these occupancies is the percentage of CPU time the scheduler spends in a given time sample.

At the beginning of the transfer period, the system initializes CPSSCHED to the current value of the CPU scheduler occupancy. The system updates the occupancy values from CPSTATUS data at 1 min intervals during the transfer period. Each time the occupancy increases, register CPSSCHED accumulates the value.

To obtain the average CPU scheduler occupancy for 1 min, divide the holding register value by the transfer period. Measure the transfer period in minutes.

Register CPSSCHED release history

CPSSCHED was introduced in BCS25.

Associated registers

There are no associated registers.

Associated logs

There are no associated logs.

Register CPSSNIP

CPU status of SuperNode internet protocol class (CPSSNIP)

OM group CPUSTAT (end)

Register CPSSNIP measures the CPU use of the SuperNode internet protocol (SNIP) scheduler class on SuperNode cores.

Note: This register does not apply to BRISC SuperNode cores.

Register CPSSNIP release history

Register CPSSNIP was introduced in BCS36.

Associated registers

There are no associated registers.

Associated logs

There are no associated logs.

OM group CSL

OM description

Console device maintenance summary (CSL)

The OM group CSL counts errors and faults, and records system or manual busy use for console devices. Console devices include teletypewriters and MAP terminals. Use the data collected by CSL to assess the performance of the console devices.

CSL has four registers. Two peg registers count console device errors and faults.

Two usage registers record if console devices are system busy or manual busy.

Release history

The OM group CSL was introduced in BCS20.

BCS33

Registers CSLSBU and CSLMBU were added to OM group CSL in BCS33. Use the OMSHOW command on the ACTIVE class to change these registers from CCS to deci-erlangs before display.

BCS21

Software changed for OM group CSL in BCS21 to provide usage counts in CCS or deci-erlangs.

Registers

The OM group CSL registers appear on the MAP terminal as follows:



CSLERR CSLFLT CSLSBU CSLMBU

Group structure

The OM group CSL provides one tuple for each office.

Key field:

There is no Key field

Info field:

There is no Info field

Associated OM groups

There are no associated OM groups.

OM group CSL (continued)

Associated operational groups

The following operational groups associate with OM group CSL:

- DMS-100 Local
- DMS-100/200 Local/Toll
- DMS-100/200 Local/Toll with TOPS
- DMS-200 Toll
- DMS-200 with TOPS
- DMS-100 Meridian
- DMS-MTX Mobile Telephone Exchange
- DMS-250 Toll/Tandem
- DMS-300 Gateway
- Meridian SL-100 PBX

Associated functionality codes

The associated functionality codes with OM group CSL appear in the following table.

Functionality	Code
Common Basic	NTX001AA
OMs in Erlangs	NTX664AA

OM group CSL (continued)

OM group CSL registers

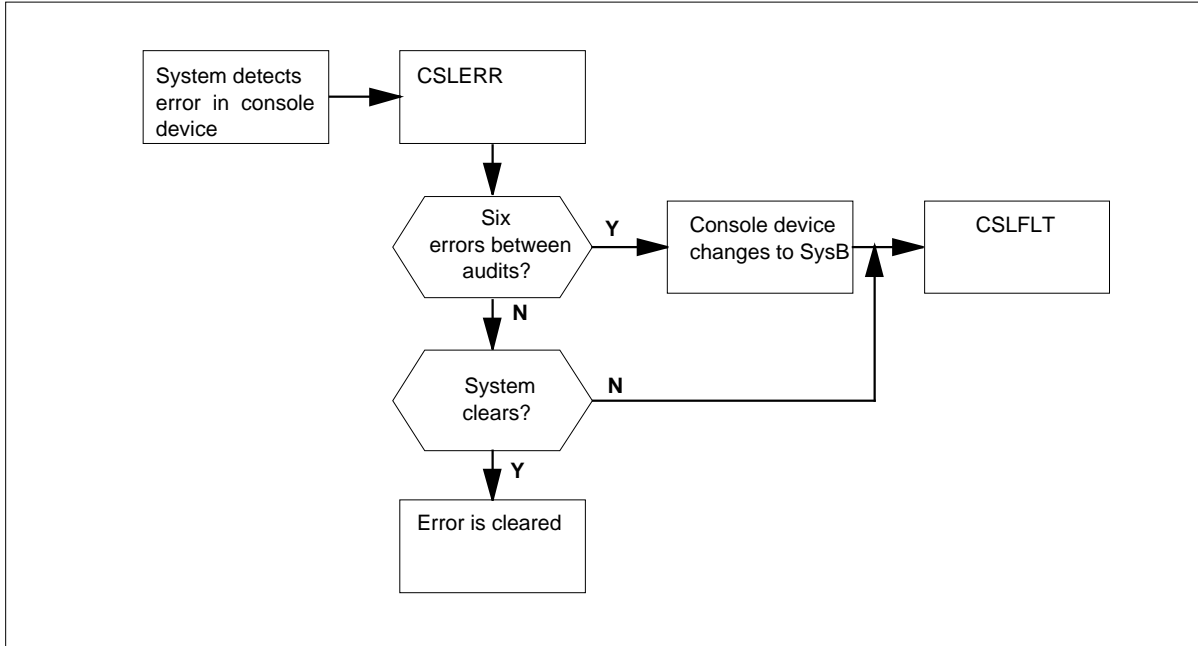

OM group CSL (continued)

OM group CSL usage registers

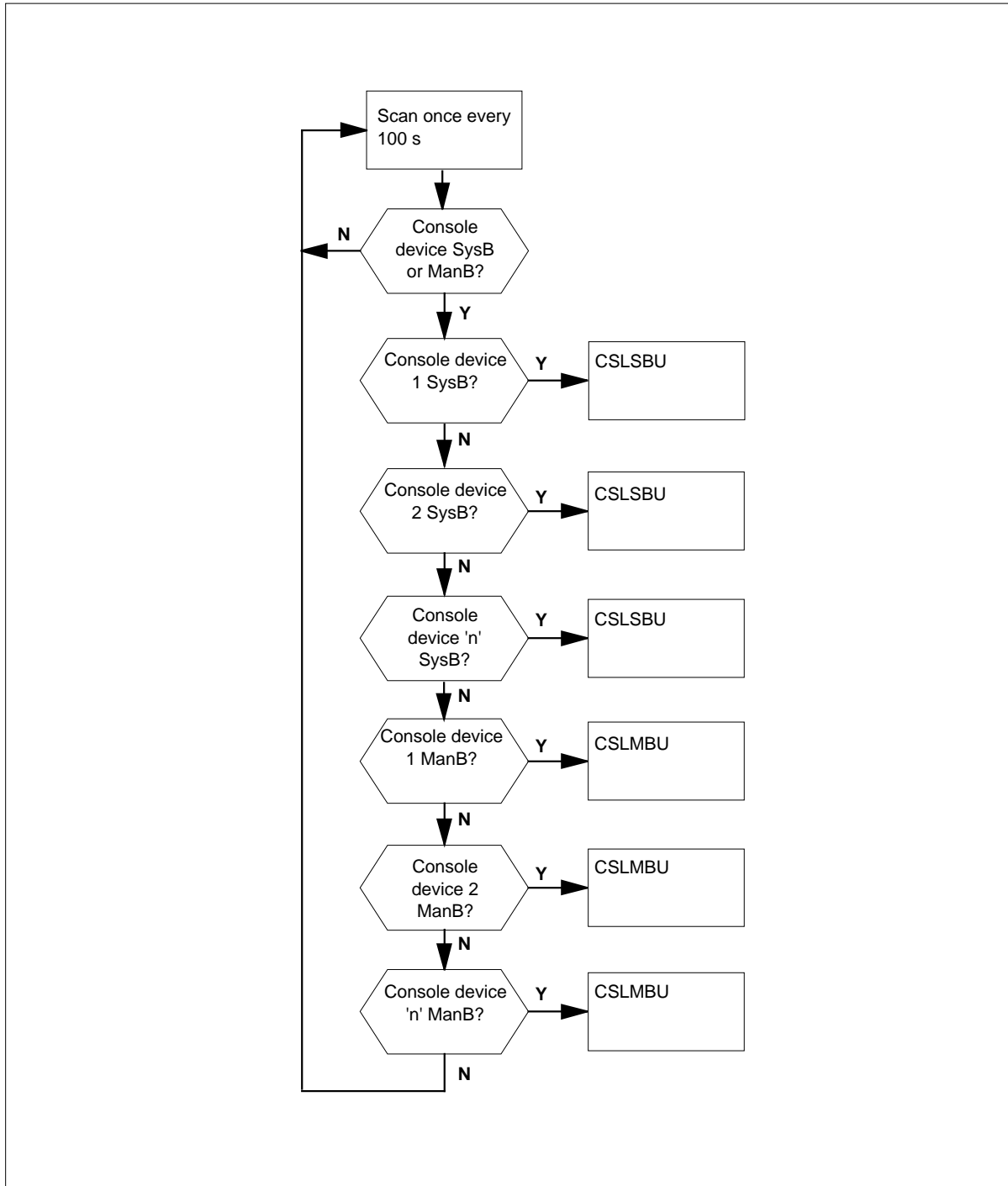

OM group CSL (continued)

Register CSLERR

Console device errors (CSLERR)

Register CSLERR counts console device errors. The count includes errors that clear and errors that make a console device system busy.

The errors that CSLERR counts include

- transmission errors between the central control (CC) and the input/output device (IOD) controller that cause messages to rebound.
- time outs of an IOD controller before the controller returns a required response
- transmission of dataset-not-ready or bad-message responses by a device controller

For a single console device, the system attempts to clear up to five errors that occur between following maintenance audits. If a sixth error occurs, the system makes the console device system busy.

Register CSLERR release history

Register CSLERR was introduced before BCS20.

Associated registers

Register CSLFLT counts faults that make a console device system busy.

Associated logs

The system generates IOD120 when the system detects a difference between current maximum device number (MDN) and expected maximum device number. If the system updates the MDN, the system generates the UPDATED in the log. If the system cannot update the MDN, the system generates MISMATCH in the log.

The system generates IOD306 to indicate that different console device errors occurred.

The system generates IOD310 to indicate that the file system detects a fault in a terminal.

The system generates IOD311 to indicate that a message-related error occurred on a terminal.

The system generates IOGA101 when the I/O handler processes a fault reports related to a messaging fault on a node of the switch.

OM group CSL (continued)

The system generates IOGA105 generates when a node on the switch reports a fault on a node C-side link. Control of the link transfers to the node that interfaces with the C-side of the link.

Register CSLFLT

Console device faults (CSLFLT)

Register CSLFLT counts faults that make a console device system busy. The faults that CLSFLT count include:

- console device errors that system action cannot clear
- the sixth error that occurs between following maintenance audits in a single console device

The system attempts to clear up to five errors that occur between following audits on a single console device. If a sixth error occurs, the system makes the console device system busy. The console device remains system busy or disconnects until manual or system interruption returns to service the console.

Register CSLFLT release history

Register CSLFLT was introduced in BCS20.

Associated registers

Register CSLERR counts console device errors. The count includes errors that the system can clear and errors that make the console device system busy.

Associated logs

The system generates IOD119 when the system detects a messaging fault between:

- a console device and the I/O controller (IOC)
- the IOC and the central message controller (CMC)

The system generates IOD307 to indicate that a loop test on a console device fails.

The system generates IOD308 to indicate that a terminal controller detects a fault on a console device.

Register CSLMBU

Console device manual busy use (CSLMBU)

Register CSLMBU is a usage register. The scan rate is 100 s. Register CSLMBU records if console devices are manual busy.

OM group CSL (continued)

Register CSLMBU release history

Register CSLMBU was introduced before BCS20.

BCS33

When you set office parameter OMINERLANGS to Y, you convert the usage count from CCS to deci-erlangs before the count appears. Use the OMSHOW command on the ACTIVE class to display the usage count. The value in the active register remains in CCS.

BCS21

Software changed for register CSLMBU in BCS21 to provide usage counts in either CCS or deci-erlangs.

Associated registers

Register CSLSBU records if console devices are system busy.

Associated logs

The system generates IOD303 when the system makes a console device manual busy.

The system generates IOD312 when a console device that displays logs becomes P-side busy. An interruption of the power supply or a command from the MAP terminal can make the console device P-side busy.

Register CSLSBU

Console device system busy use (CSLSBU)

Register CSLSBU is a usage register. The scan rate is 100 s. Register CSLSBU records if console devices are system busy.

Register CSLSBU release history

Register CSLSBU was introduced before BCS20.

BCS33

When you set office parameter OMINERLANGS to Y, you convert the usage count from CCS to deci-erlangs before the count appears. Use the OMSHOW command on the ACTIVE class to display the usage count. The value in the active register remains in CCS.

BCS21

Software changed for register CSLSBU to provide usage counts in CCS or deci-erlangs.

OM group CSL (end)

Associated registers

Register CSLMBU records if console devices are manual busy.

Associated logs

The system generates IOD304 when a console device becomes system busy for one of the following reasons:

- a file system error
- to perform an audit
- a message overload condition

The system generates IOD312 when a console device that displays logs becomes P-side busy. An interruption of the power supply or a command at the MAP can make the console device P-side busy.

OM group DAISGEN

OM description

General data access/information services OMs (DIASGEN)

The OM group DAISGEN provides information on data access/information services (DAIS) in the enhanced input/output controller (EIOC). The OM group DAISGEN counts the following activities:

- system events
- connect events
- refuse events
- release events
- not-finish events
- abort events
- protocol errors
- system errors

Release history

The OM group DAISGEN was introduced in BCS27.

BCS32

Registers for the OM group DAISGEN in BCS32 by the Call History Information Processing System (CHIPS) Enhanced File Transfer feature.

Registers

The OM group DAISGEN registers appear on the MAP terminal as follows:

DAISSYEV	DAISCOEV	DAISREEV	DAISRLEV
DAISNFEV	DAISABEV	DAISPRER	DAISSYER

Group structure

The OM group DAISGEN provides one tuple for each office.

Key field:

There is no Key field

Info field:

There is no Info field

OM group DAISGEN (continued)

Associated OM groups

The DUTLGEN OM group provides the same measurements for the DMS common transport layer.

Associated operational groups

The operational group EIOC associates with OM group DAISGEN.

Associated functionality codes

The associated functionality codes for the OM group DAISGEN appear in the following table.

Functionality	Code
CNS—Data Access Interface	NTXG13AA

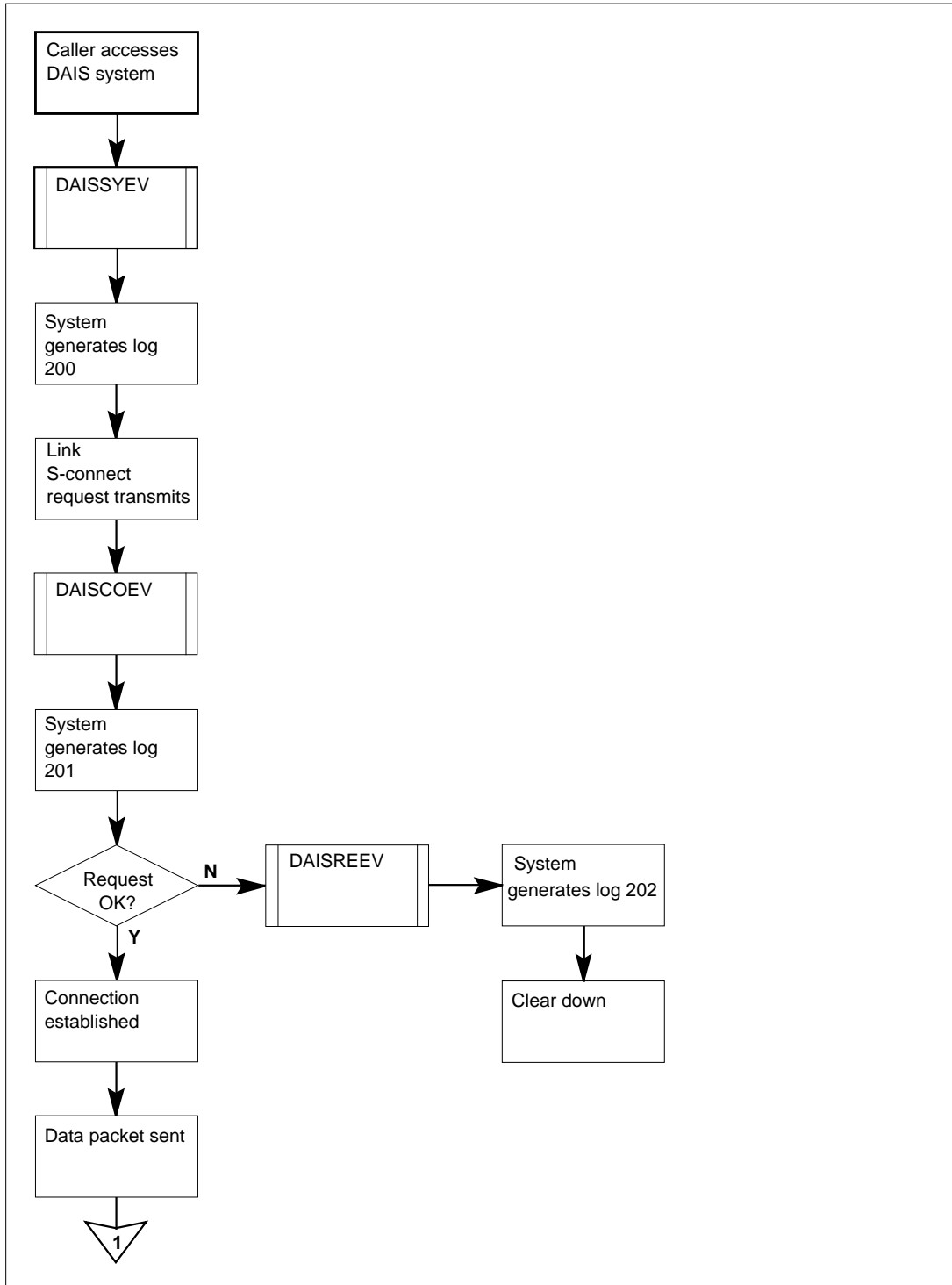
OM group DAISGEN (continued)**OM group DAISGEN registers**

OM group DAISGEN (continued)

OM group DAISGEN registers (continued)

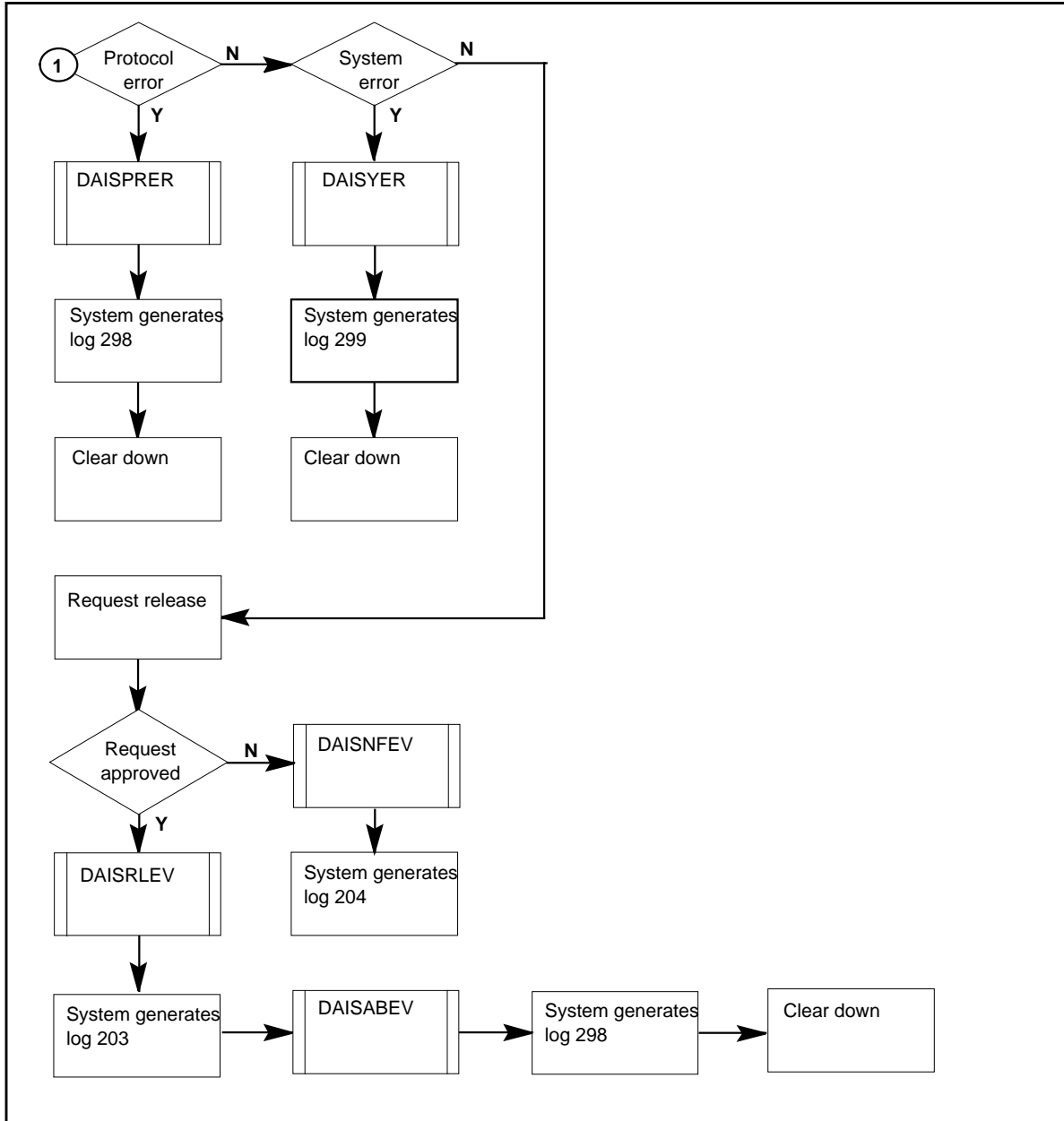

Register DAISABEV

Data access/information services (DAIS) abort events (DAISABEV)

Register DAISABEV counts abort events that occur in DAIS in the EIOC. An abort event occurs when a DAIS link sends or receives a system disconnect request, and receives or sends confirmation.

OM group DAISGEN (continued)

Register DAISABEV release history

Register DAISABEV was introduced in BCS27.

Associated registers

There are no associated registers.

Associated logs

Register DAIS297 generates when an abort event occurs. The log report includes the date, time and an explanation text.

Register DAISCOEV

DAIS connect events (DAISCOEV)

Register DAISCOEV counts connect events that occur in DAIS in the EIOC.

Register DAISCOEV release history

Register DAISCOEV was introduced in BCS27.

Associated registers

There are no associated registers.

Associated logs

The system generates DAIS201 when a connect event occurs. The log report includes the date, time, and an explanation text.

Register DAISNFEV

DAIS not-finish events (DAISNFEV)

Register DAISNFEV counts not-finish events that occur in DAIS in the EIOC.

A not-finish event occurs when a DAIS link sends a release request and receives a release reject. A not-finish event also occurs when a DAIS link receives a release request and sends a release reject.

Register DAISNFEV release history

Register DAISNFEV was introduced in BCS27.

Associated registers

There are no associated registers.

Associated logs

The system generates DAIS204 when a not-finish event occurs.

OM group DAISGEN (continued)

Register DAISPRER

DAIS protocol errors (DAISPRER)

Register DAISPRER counts protocol errors that occur in DAIS.

Register DAISPRER release history

Register DAISPRER was introduced in BCS27.

Associated registers

There are no associated registers.

Associated logs

The system generates DAIS298 when a protocol error occurs. The log report includes the date, time, and explanation text.

Register DAISREEV

DAIS refuse events (DAISREEV)

Register DAISREEV counts refuse events that occur in DAIS in the EIOC.

Register DAISREEV release history

Register DAISREEV was introduced in BCS27.

Associated registers

There are no associates registers.

Associated logs

The system generates DAIS202 when a refuse event occurs. The log report includes date, time, and explanation text.

Register DAISRLEV

DAIS release events (DAISRLEV)

Register DAISRLEV counts release events that occur in DAIS in the EIOC. A release event occurs when a DAIS link sends a release request and receives confirmation.

Register DAISRLEV release history

Register DAISRLEV was introduced in BCS27.

Associated registers

There are no associated registers.

OM group DAISGEN (end)

Associated logs

The system generates DAIS203 when a release event occurs. The log report includes date, time, and explanation text.

Register DAISSYER

DAIS system errors (DAISSYER)

Register DAISSYER counts system errors that occur in DAIS.

Register DAISSYER release history

Register DAISSYER was introduced in BCS27.

Associated registers

There are no associated registers.

Associated logs

DAIS299 generates when a system error occurs. The date, time, and explanation text are included in the log report.

Register DAISSYEV

DAIS system events (DAISSYEV)

Register DAISSYEV counts system events that occur in DAIS in the EIOC.

Register DAISSYEV release history

Register DAISSYEV was introduced in BCS27.

Associated registers

There are no associated registers.

Associated logs

The system generates DAIS200 when a system event occurs. The log report includes date, time, and explanation text.

OM group DCADTALG

OM description

Dynamically Controlled Access Detection Algorithm State Transitions (DCADTALG)

The OM group DCADTALG measures the Dynamically Controlled Access Detection (DCA) detection operation by counting the detection cycles. The OM group DCADTALG measures the changes of state associated with mass call event (MCE) directory number (DN) in the detection algorithm.

The OM group DCADTALG contains registers that are pegged when changes occur or fail in the detection algorithm. You can adjust the detection thresholds and operational parameters to minimize the number of wrongly suspected calls. You can adjust detection thresholds and operational parameters to minimize real-time impact without exceeding the algorithm capacity.

Release history

The OM group DCADTALG was introduced in NA004.

Registers

The following OM registers appear on the MAP terminal as follows:

CYCLES	CLRTHRESH	SUSTOMON	MONTOCLR
SAMOFLO	SUSC	MONOW	

Group structure

The OM group DCADTALG provides one tuple for each office.

Key field:

There is no key field.

Info field:

There is no info field.

Associated OM groups

There are no associated OM registers.

Associated functional groups

The DCA functional groups are associated with OM group DCADTALG.

Associated functionality codes

The functionality codes associated with OM group DCADTALG appear in the following table.

Functionality	Code
DCA Detection	A00002

Register CYCLES

Register Number Cycles (CYCLES)

The CYCLES register counts the detection cycles. Each change of state can occur one time for each DCA and each cycle.

Register CYCLES release history

NA004

The CYCLES register was introduced in NA004.

Associated registers

There are no associated registers.

Associated logs

There are no associated logs.

Extension registers

There are no extension registers.

Register CLRTOSUS

Register Clear to Suspect (CLRTOSUS)

The CLRTOSUS registers counts the DN that are suspected MCE targets based on the ineffective attempt rate measured during sampling.

Register CLRTOSUS release history

NA004

The CLRTOSUS registers was introduced in NA004.

OM group DCADTALG (continued)

Associated registers

There are no associated registers.

Associated logs

There are no associated logs.

Extension registers

There are no extension registers.

Register SUSTOCLR

Register Suspended to Clear (SUSTOCLR)

The SUSTOCLR register counts the DNSs that are not MCE targets after having been suspected.

Register SUSTOCLR release

NA004

The SUSTOCLR register was introduced in NA004.

Associated registers

There are no associated registers.

Associated logs

There are no associated logs.

Extension registers

There are no extension registers.

Register SUSTOMON

Register Suspended Monitor (SUSTOMON)

The SUSTOMON register counts the DNSs that are MCE targets after having been suspected.

Register SUSTOMON release history

The SUSTOMON register was introduced in NA004.

Associated registers

There are no associated registers.

Associated logs

There are no associated logs.

Extension registers

There are no extension registers.

Register MONTOCLR

Register Monitor Clear (MONTOCLR)

The MONTOCLR register counts the DN that are the targets of MCEs that cleared.

Register MONTOCLR release history

NA004

The MONTOCLR register was introduced in NA004.

Associated registers

There are no associated registers.

Associated logs

There are no associated logs.

Extension registers

There are no extension registers.

Register SAMOFLOW

Register Sampling overflow (SAMOFLOW)

The SAMOFLOW register counts ineffective attempts that occur during sampling but are not recorded. The register does not record because the SAMPLE_SIZE limit has been reached.

Register SAMOFLOW release history

NA004

The SAMOFLOW register was introduced in NA004.

Associated registers

There are no associated registers.

Associated logs

There are no associated logs.

OM group DCADTALG (end)

Extension registers

There are no extension registers.

Register SUSOFLOW

Register Suspected overflow (SUSOFLOW)

The SUSOFLOW register counts the DNs that must be suspected but cannot be recorded because the NUM_SUSPECT limit has been reached.

Register SUSOFLOW release history NA004

The SUSOFLOW register was introduced in NA004.

Associated registers

There are no associated registers.

Associated logs

There are no associated logs.

Extension registers

There are no extension registers.

Register MONOFLOW

Register Monitor overflow (MONOFLOW)

The MONOFLOW register counts the DNs that are the targets of MCEs but cannot be monitored because the NUM_MONITOR limit has been reached.

Register MONOFLOW release history NA004

The MONOFLOW register was introduced in NA004.

Associated registers

There are no associated registers.

Associated logs

There are no associated logs.

Extension registers

There are no extension registers.

OM group DCAIA

OM description

Dynamically Cont... effective Attempts (DCAIA)
The DCAIA op... (D) group counts and classifies ineffective attempts to measure switch conditions. The DCA detection records these attempts.

Release history

NA004

The OM group DCAIA was introduced in NA004.

Registers

The following C... group DCAIA registers appear on the MAP terminal as follows:

TOTAL	TRMT	SUP
-------	------	-----

Group structure

The OM group DCAIA provides one tuple for each office.

Key field:

There is no key field.

Info field:

There is no info field.

Associated OM groups

The OM group DCAIA provides information on how to measure the switch conditions that relate to MCLs.

Associated functional groups

The DCA functional group is associated with OM group DCAIA.

Associated functionality codes

The functionality codes for OM group DCAIA appear in the following table:

Functionality	Code
DCA Detection	DCA00002

OM group DCAIA (continued)

OM group DCAIA registers

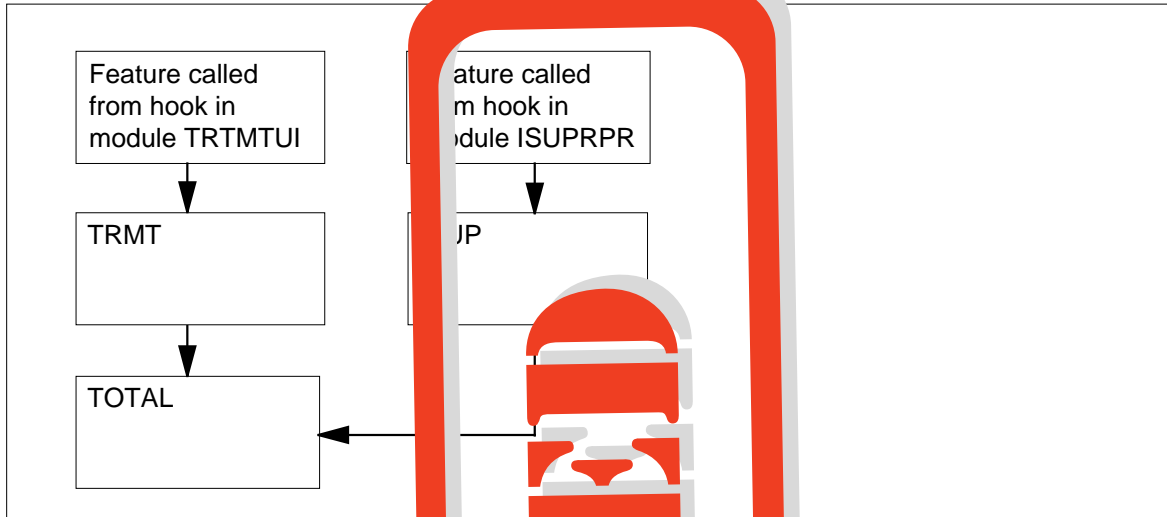

Register TOTAL

Register Total (TOTAL)

The TOTAL register counts termination failures that the DCA considers ineffective attempts.

Register TOTAL release history

The TOTAL register was introduced in November 2004.

Associated registers

There are no associated registers.

Associated logs

There are no associated logs.

Extension registers

There are no extension registers.

Register TRMT

Register Treatment (TRMT)

The TRMT register counts termination failures that the DCA considers to be ineffective attempts for calls that involve the application of treatment.

Register TRMT release history

The TRMT register was introduced in November 2004.

Associated registers

There are no associated registers.

Associated logs

There are no associated logs.

Extension register

There are no extension registers.

Register ISUP

Register integrated service network (ISDN) User Part (ISUP)

The ISUP register could terminate on failures that the DCA considers to be ineffective attempts for calls that involve the relay of an ISUP message.

Register ISUP release history

The ISUP register was introduced in NA 4.

Associated registers

There are no associated registers.

Associated logs

There are no associated logs.

Extension registers

There are no extension registers.

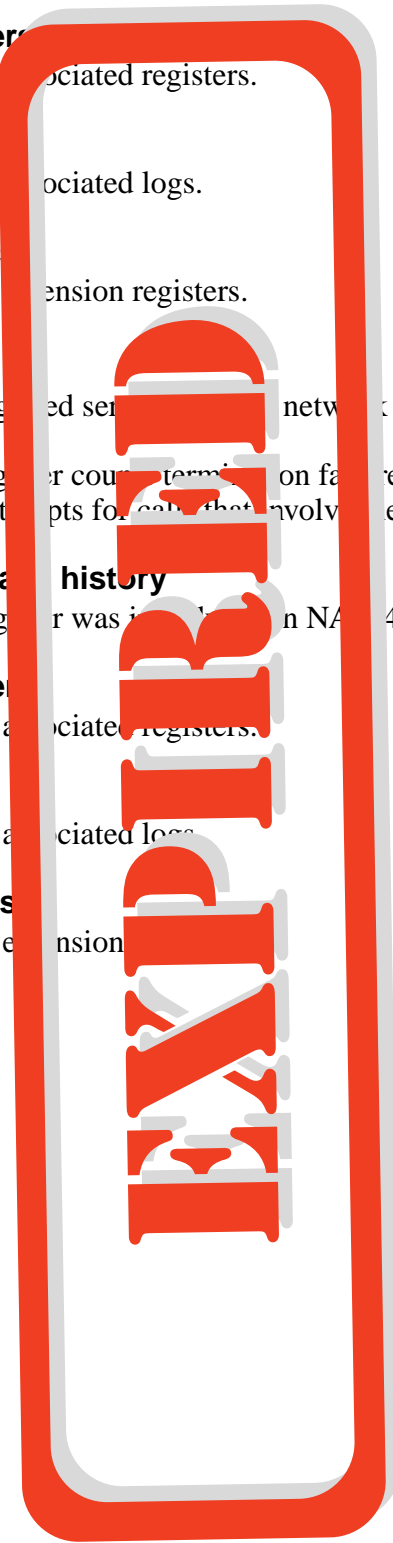

OM group DCAMCEIA

OM description

Dynamically Controlled Access (DCA) Ineffective Attempts for Mass Call Event (DCAMCEIA)

The DCAMCEIA operational measurement (OM) group, counts and classifies ineffective attempts toward directory numbers (DN) to measure switch conditions. These switch conditions relate to mass call events (MCE). The ineffective attempts are targets of MCEs. The collected counts, provide information on patterns of the switch.

Release history

NA004

The DCAMCEIA was introduced in NA004.

Registers

The registers for OM group DCAMCEIA appear on the MAP terminal as follows:

TO	FR	FR_LINE	FR_TRUNK
TO	TO TRUNK	OTHER	

Group structure

The DCAMCEIA provides one tuple for each office.

- Key field:** There is one key field.
- Information field:** There is one information field.

Associated OM groups

The DCAMCEIA provides information on the ineffective attempts that the DCA detects, records.

Associated functional groups

The DCAMCEIA functional groups associate with the OM group DCAMCEIA.

OM group DCAMCEIA (continued)

Associated functions

The function codes for OM group DCAMCEIA appear in the following table:

Function	Code
DCA Description	DCA00002

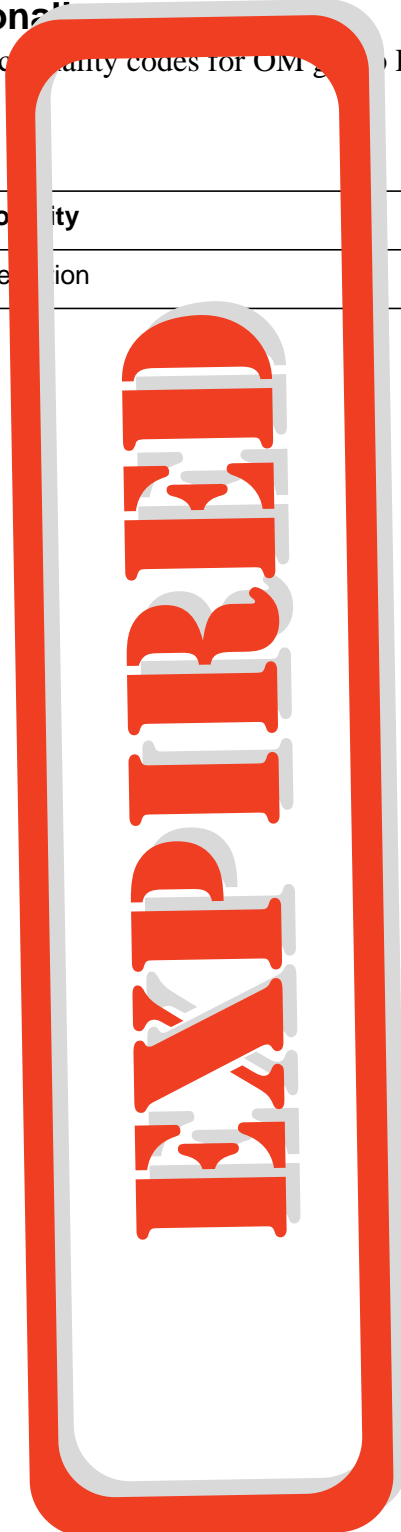

OM group DCAMCEIA (continued)

OM group DCAMCEIA regis

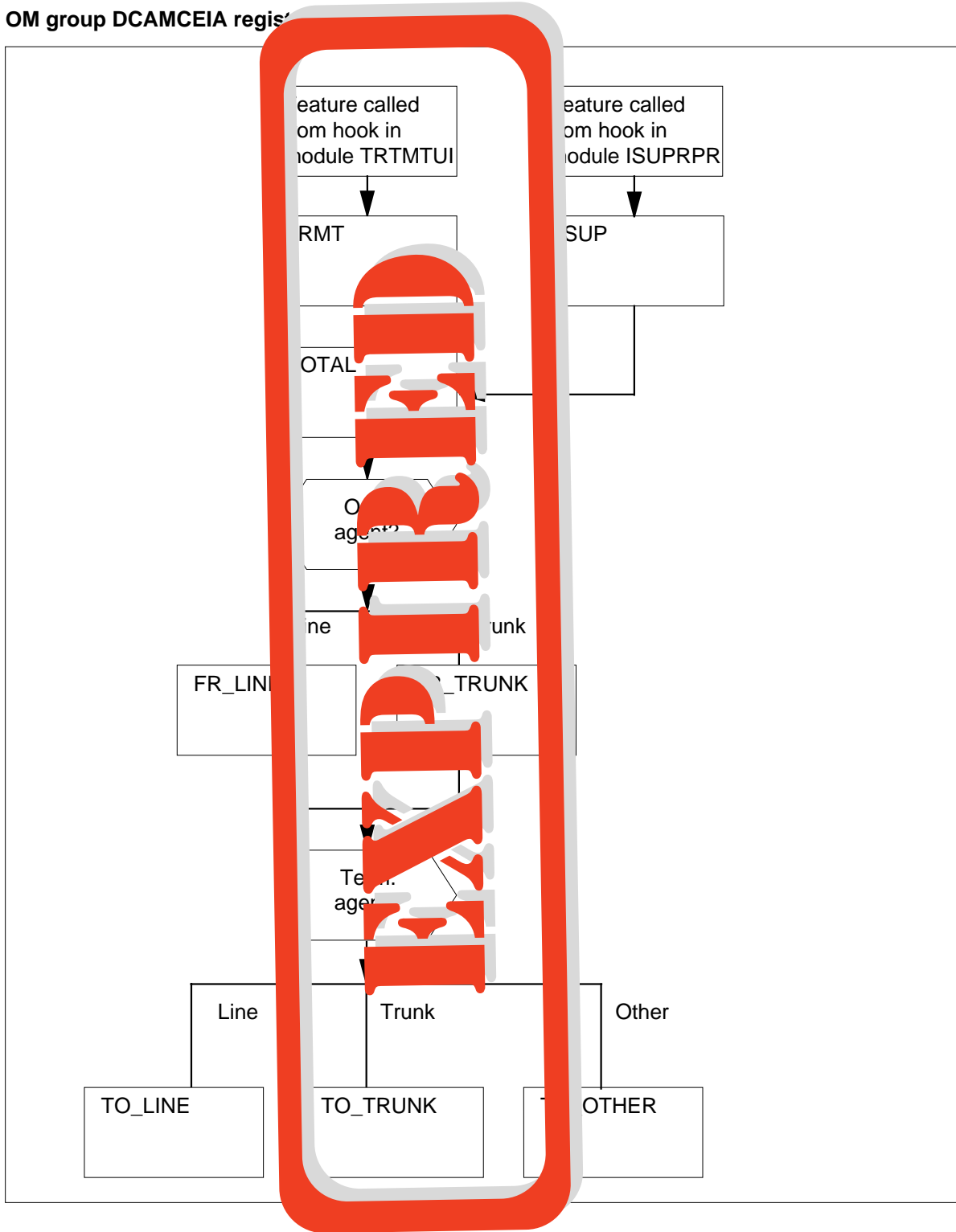

OM group DCAMCEIA (continued)

Register TOTAL

Register Total (TOTAL)

The TOTAL register counts the termination failures that the DCA considers ineffective attempts toward DNS. The DNSs are the targets of MCEs.

Register TOTAL release history

NA004

The TOTAL register was created in NA004.

Associated registers

There are no associated registers.

Associated logs

There are no associated logs.

Extension registers

There are no extension registers.

Register TRMT

Register Treatment (TRMT)

The TRMT register counts the termination failures that the DCA considers ineffective attempts that involve the application of treatment. The DNSs are the targets of MCEs for calls that involve the application of treatment.

Register TRMT release history

NA004

The TRMT register was created in NA004.

Associated registers

There are no associated registers.

Associated logs

There are no associated logs.

Extension registers

There are no extension registers.

OM group DCAMCEIA (continued)

Register ISUP

Register Integrated services digital network (ISDN) User Part (ISUP)

The ISUP register counts the termination failures that the DCA considers ineffective attempts toward DNs. The DNs are the targets of MCEs, for calls that involve the relay of an ISUP message.

Register ISUP release history

NA004

The ISUP register is defined in NA004.

Associated registers

There are no associated registers.

Associated logs

There are no associated logs.

Extension registers

There are no extension registers.

Register FR_LINE

Register Foreign Line (FR_LINE)

The FR_LINE register counts the termination failures that the DCA considers ineffective attempts toward DNs. The DNs are the targets of MCEs for calls that come from a line.

Register FR_LINE release history

NA004

The FR_LINE register is defined in NA004.

Associated registers

There are no associated registers.

Associated logs

There are no associated logs.

Extension registers

There are no

OM group DCAMCEIA (continued)

Register FR_TRUNK

Register From Trunk (FR_TRUNK)

The FR_TRUNK register counts the termination failures that the DCA considers ineffective attempts toward DNSs. These DNSs are the targets of MCEs for calls that come in on a trunk.

Register FR_TRUNK release history

NA004

The FR_TRUNK register was added in NA004.

Associated registers

There are no associated registers.

Associated logs

There are no associated logs.

Extension registers

There are no extension registers.

Register TO_LINE

Register To Line (TO_LINE)

The TO_LINE register counts the termination failures that the DCA considers ineffective attempts toward DNSs. These DNSs are the targets of MCEs for calls that a line completes.

Register TO_LINE release history

NA004

The TO_LINE register was added in NA004.

Associated registers

There are no associated registers.

Associated logs

There are no associated logs.

Extension registers

There are no extension registers.

OM group DCAMCEIA (continued)

Register TO_TRUNK

Register TO_TRUNK (TO_TRUNK)

The TO_TRUNK register counts termination failures that the DCA considers ineffective attempts toward DNs. These DNs are the targets of MCEs for calls that go out on a trunk.

Register TO_TRUNK release history

NA004

The TO_TRUNK register was introduced in NA004.

Associated registers

There are no associated registers.

Associated logs

There are no associated logs.

Extension registers

There are no extension registers.

Register TO_OTHER

Register TO_OTHER (Other Terminator Type TO_OTHER)

The TO_OTHER register counts the termination failures that the DCA considers ineffective attempts toward DNs. These DNs are the targets of MCEs. They are the targets for calls that go out on an agent that is not a line or a trunk.

Register TO_OTHER release history

NA004

The TO_OTHER register was introduced in NA004.

Associated registers

There are no associated registers.

Associated logs

There are no associated logs.

Extension regis

There are no extension registers



OM group DCM

OM description

The OM group Digital carrier module maintenance summary (DCM)

The OM group DCM provides maintenance measurements for digital carrier modules (DCM).

The OM group DCM contains nine registers that count the following:

- errors detected in in-service DCMs
- circuit diagnostics
- DCMs that become manual busy and system busy
- terminals that the system cuts off because DCMs become manual busy or system busy
- outside plant circuit failures

Two usage registers record if DCMs are system busy or manual busy.

Release history

The OM group DCM was introduced before BCS20.

BCS33

When you set office parameter OMINERLANGS to Y, you convert the usage count from CCS to deci-erlangs before the count appears. Use the OMSHOW command on the ACTIVE class to display the usage count. The value in the active registers remains in CCS.

BCS30

Software changed for the OM group DCM to provide use counts in CCS or deci-erlangs.

Registers

The OM group DCM registers appear on the MAP terminal as follows:

DCMERR	DCMFLT	DCMSBU	DCMMBU
DCMCCTDG	DCMCCTFL	DCMMBP	DCMSBP
DCMMBTCO	DCMSBTCO	DCMCCTOP	

Group structure

The OM group DCM provides one tuple for each office.

OM group DCM (continued)

Key field:

There is no Key field

Info field:

There is no Info field

Associated OM groups

The OM group PM provides maintenance measurements for each peripheral module.

The OM group PMTYP totals the registers in group PM for each peripheral module type.

Associated operational groups

There are no associated operational groups.

Associated functionality codes

The associated functionality codes for the OM group DCM appear in the following table.

Functionality	Code
Common Basic	NTX001AA

OM group DCM (continued)

OM group DCM registers

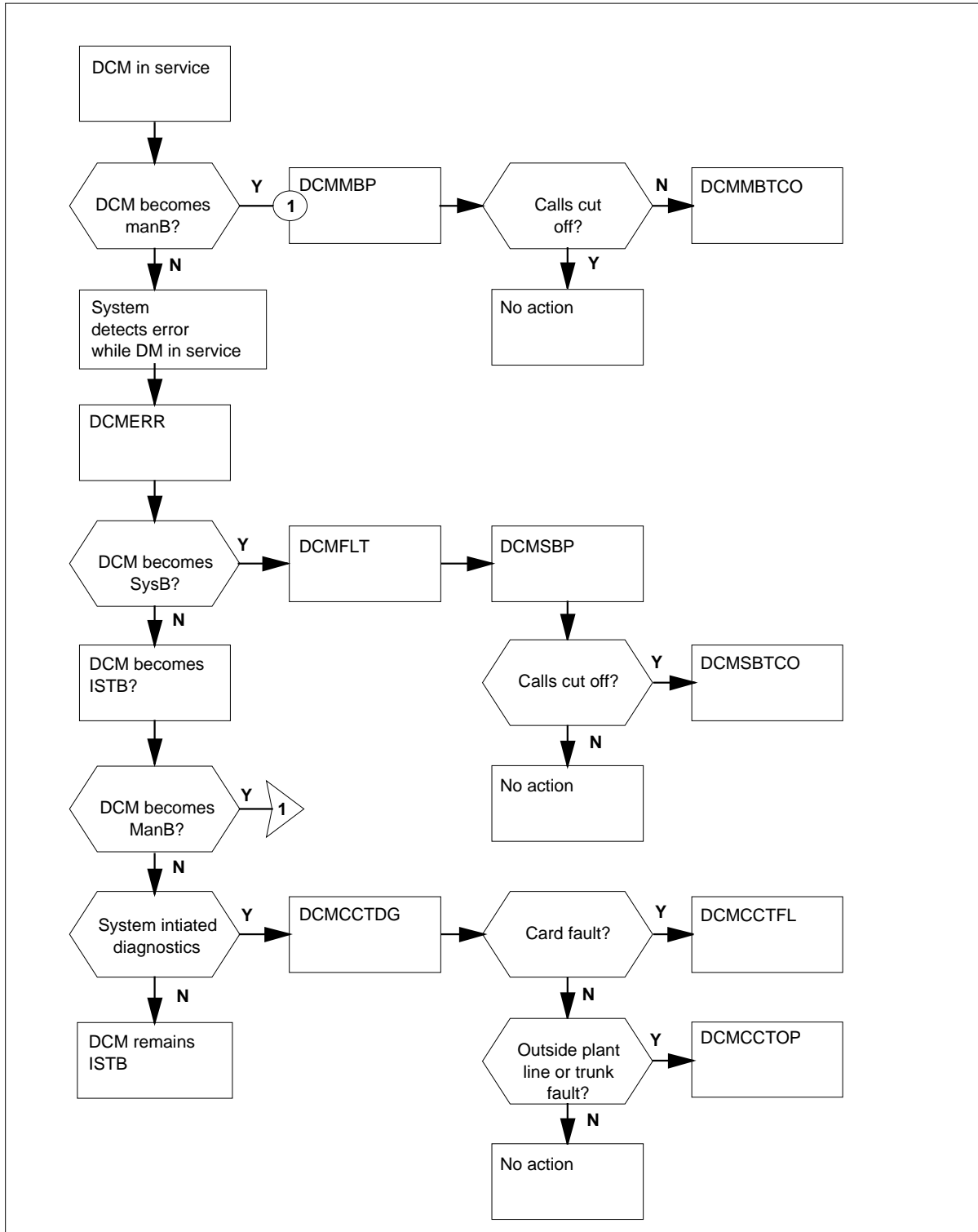

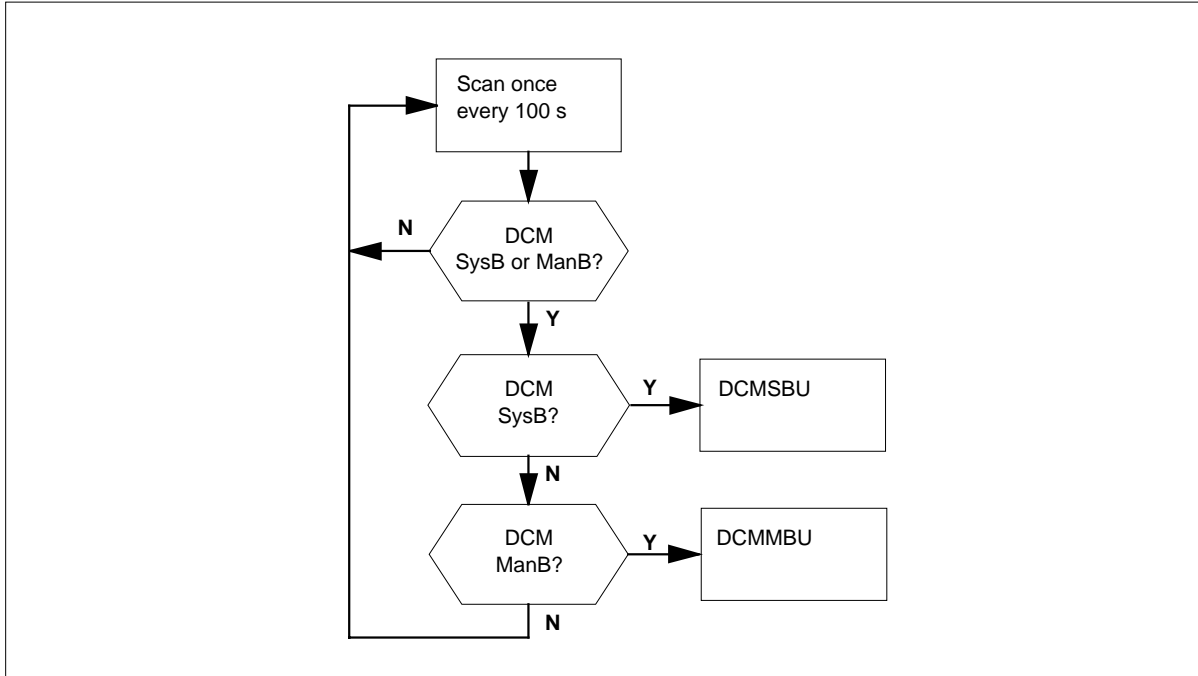
OM group DCM (continued)**OM group DCMuse registers****Register DCMCCTDG**

Digital carrier module (DCM) circuit diagnostics run (DCMCCTDG)

Register DCMCCTDG increases when the system sends a DMC trunk to maintenance software because of repeated problems during call processing. The maintenance software checks if:

- the system removes the DCMs DS-1 trunk card
- the DS-1 set of cards has an alarm in the local group or the remote carrier group

Register DCMCCTDG release history

Register DCMCCTDG was introduced before BCS20.

Associated registers

Register PM_PMCCTDG increases when the system sends a DCM trunk to maintenance software because of repeated problems during call processing.

Register PMTYP_PMTCTDG is the total of register PM_PMCCTDG for the peripheral module (PM) type.

OM group DCM (continued)

Associated logs

There are no associated logs.

Register DCMCCTFL

Digital carrier module (DCM) circuit diagnostics failed (DCMCCTFL)

Register DCMCCTFL increases when:

- the system refers a trunk on a DCM to maintenance software for checking because of repeated problems during call processing
- the system removed the related DS-1 line card
- the DS-1 set of cards has an alarm in the local group or the remote carrier group

Register DCMCCTFL release history

Register DCMCCTFL was introduced before BCS20.

Associated registers

Register PM_PMCCTFL increases when:

- the system sends a DCM trunk to maintenance software because of repeated problems during call processing
- the system removed the related DS-1 line card
- the DS-1 set of cards has an alarm in the local group or the remote carrier group

Register PMTYP_PMTCCTFL is the total of register PM_PMCCTFL for the peripheral module (PM) type.

Associated logs

There are no associated logs.

Register DCMCCTOP

Digital carrier module (DCM) circuit diagnostics outside plant (DCMCCTOP)

Register DCMCCTOP counts outside plant circuit failures that diagnostics called by the signaling test system detect. Register DCMCCTOP increases when the originating office does not receive a start-dial or wink signal from the far-end office. The start-dial responses to the off-hook signal that the originating office sends.

OM group DCM (continued)

Register DCMCCTOP increases when the diagnostic first detects a fault. Register DCMCCTOP does not increase when the diagnostic detects the fault on subsequent retests.

Register DCMCCTOP release history

Register DCMCCTOP was introduced before BCS20.

Associated registers

Register PM_PMCCTOP counts outside plant circuit failures diagnostics called by the signaling test system detects. Register PMCCTOP increases when the originating office does not receive a start-dial or wink signal from the far-end office. The start-dial or wink signal are responses to the off-hook signal that the originating office sends.

Register PMTYP_PMTCCTOP is the total of register PM_PMCCTOP for the PM type.

Associated logs

There are no associated logs.

Register DCMERR

Digital carrier module (DCM) errors (DCMERR)

Register DCMERR counts errors that the system detects in an in-service DCM. Register DCMERR increases when an in-service DCM:

- reports a software error, a RAM parity failure, a DCM firmware error, or DCM controller message congestion
- experiences an integrity failure
- fails a test during a routine or initializing audit
- raises a WAI (who-am-I) flag that indicates that processing in the DCM failed completely
- fails to respond to messages

Register DCMERR increases without regard for if the system takes action on the error.

Register DCMERR release history

Register DCMERR was introduced before BCS20.

Associated registers

Register PM_PMERR counts errors that the system detects in an in-service peripheral module (PM).

OM group DCM (continued)

Register PMTYP_PMTERR is the total of register PM_PMERR for the PM type.

Associated logs

There are no associated logs.

Register DCMFLT

Digital carrier module (DCM) faults (DCMFLT)

Register DCMFLT counts DCM errors that make the DCM system busy pending manual interruption or a successful system-initiated recovery attempt. Register DCMFLT increases with errors that register DCMERR increased with earlier.

Register DCMFLT release history

Register DCMFLT was introduced before BCS20.

Associated registers

Register PM_PMFLT counts peripheral module (PM) errors that make the PM system busy pending manual interruption or successful system-initiated recovery attempt.

Register PMTYP_PMTFLT is the total of register PM_PMFLT for the PM type.

Associated logs

There are no associated logs.

Register DCMMBP

Digital carrier module (DCM) transitions to manual busy (DCMMBP)

Register DCMMBP counts digital carrier modules (DCM) that are in-service or in in-service trouble, and become manual busy.

Register DCMMBP release history

Register DCM was introduced before BCS20.

Associated registers

Register PM_PMMBP counts peripheral modules (PM) that are in-service or in in-service trouble, and become manual busy.

Register PMTYP_PMTMBP is the total of register PM_PMMBP for the PM type.

OM group DCM (continued)

Associated logs

There are no associated logs.

Register DCMMBTCO

Digital carrier module (DCM) manual busy terminals cut off (DCMMBTCO)

Register DCMMBTCO counts terminals that the system cut off when the system makes an in-service DCM manual busy.

Register DCMMBTCO release history

Register DCMMBTCO was introduced before BCS20.

Associated registers

Register PM_PMMBTCO counts terminals that the system cut off when the system makes an in-service peripheral module (PM) manual busy.

Register PMTYP_PMTMBTCO is the total of register PM_PMMBTCO for the PM type.

Associated logs

There are no associated logs.

Register DCMMBU

Digital carrier module (DCM) manual busy usage (DCMMBU)

Register DCMMBU is a usage register. The scan rate is 100 s. Register DCMMBU records if a DCM is manual busy.

Register DCMMBU release history

Register DCMMBU was introduced before BCS20.

BCS33

When you set office parameter OMINERLANGS is set to Y, you convert the usage count from CCS to deci-erlangs before the count appears. Use the OMSHOW command on the ACTIVE class to display the usage count. The value held in the active registers does not alter and remains in CCS.

BCS30

Software changed for the OM group DCMMBU in BCS30 to provide use counts in CCS or deci-erlangs.

OM group DCM (continued)

Associated registers

Register PM_PMMMBU records if a peripheral module (PM) is manual busy. Register PMMMBU is a usage register. The scan rate is 100 s.

Register PMTYP_PMTMMBU is the total of register PM_PMMMBU for the PM type.

Associated logs

There are no associated logs.

Register DCMSBP

Digital carrier module (DCM) transitions to system busy (DCMSBP)

Register DCMSBP counts digital carrier modules (DCM) that are in-service or in in-service trouble, and become system busy.

Register DCMSBP release history

Register DCMSBP was introduced before BCS 20.

Associated registers

Register PM_PMSBP counts peripheral modules (PM) that are in-service or in in-service trouble, and become system busy.

Register PMTYP_PMTSBP is the total of register PM_PMSBP for the PM type.

Associated logs

There are no associated logs.

Register DCMSBTCO

Digital carrier module (DCM) system busy terminals cut off (DCMSBTCO)

Register DCMSBTCO counts terminals that are call processing busy or call processing busy deload. This register counts these terminals when the DCM C-side changes state to busy from an in-service or in-service trouble state.

C-side busy is the state on the DCM before the DCM becomes system busy.

Register DCMSBTCO release history

Register DCMSBTCO was introduced before BCS20.

OM group DCM (continued)

Associated registers

Register PM_PMSBTCO counts terminals that are call processing busy or call processing busy deload. This register counts the terminals when the peripheral module (PM) C-side busy state are from an in-service or in-service trouble state. C-side busy is the state of the PM before the PM becomes system busy.

Register PMTYP_PMTSBTCO is the total of register PM_PMSBTCO for the PM type.

Associated logs

There are no associated logs.

Register DCMSBU

Digital carrier module (DCM) system busy usage (DCMBSU)

Register DCMSBU is a usage register . The scan rate 100 s. Register DCMSBU records if a DCM is system busy.

The system makes a DCM system busy if:

- the DCM fails a routine audit
- message paths to the DCM are not available
- the system receives a minimum of 200 problem reports the DCM in one 10 min audit period

The system tests system busy DCM at 1 min intervals in an attempt to restore the DCMS

Register DCMSBU release history

Register DCMSBU was introduced before BCS20.

BCS33

When you set office parameter OMINERLANGS to Y, you convert the usage count from CCS to deci-erlangs before the count appears. Use the OMSHOW command on the ACTIVE class to display the usage count. The value in the active registers remains in CCS.

BCS30

Software changed for the OM group DCM in BCS30 to provide use counts in CCS or deci-erlangs.

Associated registers

Register PM_PMMSBU records if a peripheral module (PM) is system busy. PMMSBU is a usage register. The scan rate is 100 s.

OM group DCM (end)

Register PMTYP_PMTMSBU is the total of the register PM_PMMSBU for the PM type.

Associated logs

There are no associated logs.

OM group DCMEBSS

OM description

Digital Circuit Multiplication Equipment (DCMEBSS)

This OM group counts the following signals on each occasion from the DCME to the UCS DMS-250 switch:

- no capacity for speech
- no channels available for 3.1 kHz.
- no 64 kbit/s unrestricted capacity available

A related peg count is incremented for each occasion. If the peg count exceeds the predetermined threshold value which is datafilled in table DCMEMTC, a maintenance log is generated.

Release history

OM group DCMEBSS was introduced in UCS07.

Registers

The following OM group DCMEBSS registers display on the MAP terminal as follows:

```
BSSNSPCH BSSN3K1 BSSN64K BSSNSPCU BSSN3K1U BSSN64KU
```

Datafill

Threshold value of OM registers is datafilled in the table DCMEMTC.

Group structure

OM group DCMEBSS

Key field:

none

Info field:

DCME_OMINFO_TYPE

OM group DCMEBSS (continued)

Number of tuples:
one per DCME

Associated OM groups

none

Register BSSKIP

Register Bearer Service Skip

This register measures the number of trunk groups skipped over during routing procedure that have BSSKIP control active.

Register BSSKIP release history

Register BSSKIP was introduced in UCS07.

Associated logs

none

Extension registers

none

Register BSSNSPCH

Register BSS No Capacity For Speech

This register counts the number of No Capacity for Speech signals received from DCME.

Register BSSNSPCH release history

Register BSSNSPCH was introduced in UCS07.

Associated logs

DCME105

Extension registers

none

Register BSSN3K1

Register BSS No Channels Available for 3.1 kHz

This register counts the number of No Channels Available for 3.1 kHz signals received from DCME.

OM group DCMEBSS (continued)

Register BSSNS3K1 release history

Register BSSNS3K1 was introduced in UCS07.

Associated logs

Log number: DCME105

When the peg count exceeds the predetermined threshold in a specified time in table DCMEMTC.

Extension registers

none

Register BSSN64K

Register BSS No 64 kbit/s available

This register counts the number of no 64 kbit/s unrestricted capacity available signals received from DCME.

Register BSSN64K release history

Register BSSN64K was introduced in UCS07.

Associated logs

Log number: DCME105

When the peg count exceeds the predetermined threshold in a specified time in table DCMEMTC.

Extension registers

none

Register BSSNSPCU

Register BSS No Capacity for Speech unavailability usage

This usage count is accumulated as a result of a 10 second scan of the Register BSSN64K signal.

Register BSSNSPCU release history

Register BSSNSPCU was introduced in UCS07.

Associated logs

none

OM group DCMEBSS (end)

Extension registers

none

Register BSSN3K1U

Register BSS No Channels Available for 3.1 kHz

This usage count is accumulated as a result of a 10 second scan of the Register No 3.1 kHz signal.

Register BSSNSPCU release history

Register BSSN3K1U was introduced in UCS07.

Associated logs

none

Extension registers

none

Register BSSN64KU

Register BSS No 64 kbit/s Unrestricted Capacity

This usage count is accumulated as a result of a 10 second scan of the Register No 64kbit/s Unrestricted Capacity Available signal.

Register BSSN64KU release history

Register BSSN64KU was introduced in UCS07.

Associated logs

none

Extension registers

none

OM group DCRDEST

OM description

Dynamically Controlled Routing Destination

The OM group DCRDEST provides measurements for the Dynamically Controlled Routing (DCR) feature for each office destination.

The DCR feature provides tandem routes for toll calls. The DCR feature is for calls that must go to a switch one or two links away from the originating switch. A network processor (NP) computes different tandem routes, and recommends the best route.

At normal intervals, each switch with the DCR feature sends trunk switch measurements to the NP. The NP indicates that calls to go to a DCR toll switch follow a fixed route. The calls can continue on the fixed route or go to a different tandem route. The system can block the calls.

The system provides DCRDEST for all DMS-100 Family switches with the DCR feature.

Release history

BCS20

The OM group DCRDEST was introduced before BCS20.

BCS36

The node names in table DESTKEY are the key names of the tuples of the OM incremented registers.

BCS35

Key field change to provide 253 tuples BCS35.

Registers

The registers for OM group DCRDEST appear on the MAP terminal as follows:

FRSTOFRD	DRTEOVF	BLKRECMD	CNTRECMD
RECMDOVF			

Group structure

The OM group DCRDEST provides one tuple for each DCR destination link name (maximum 253).

OM group DCRDEST (continued)

Key field:

NETNAME\$DEST_NODE_NAME is the office name of a destination that is accessible with links from the office.

Info field:

There is no info field

Enter data in four tables: DESTKEY, DESTNODE, DCROPT, and TKTONODE.

Table DESTKEY stores all DCR destinations, like destinations two or more DCR links away from the switch.

Table DESTNODE contains a tuple for every DCR destination that is one or two DCR links away from the switch.

The operating company uses table DCROPT to control the different modes of operation that the DCR package introduces.

Table TKTONODE lists the trunk group common language location identifiers (CLLI) of all incoming and two-way trunks. The system uses these trunks for DCR. This table also lists the CLLI of the originating office for each DCR trunk.

Associated OM groups

The OM group DCRICTRK provides information on DCR for each incoming trunk group.

The OM group DCRLINK provides information on DCR for each link.

The OM group DCRMISC provides information on DCR for each switch.

Associated functional groups

There are no associated functional groups.

OM group DCRDEST (continued)

Associated functionality codes

The functionality codes for OM group DCRDEST appear in the following table.

Functionality	Code
Dynamically Controlled Routing	NTX022AA
Dynamically Controlled Routing	NTX022AB

OM group DCRDEST (continued)

OM group DCRDEST registers

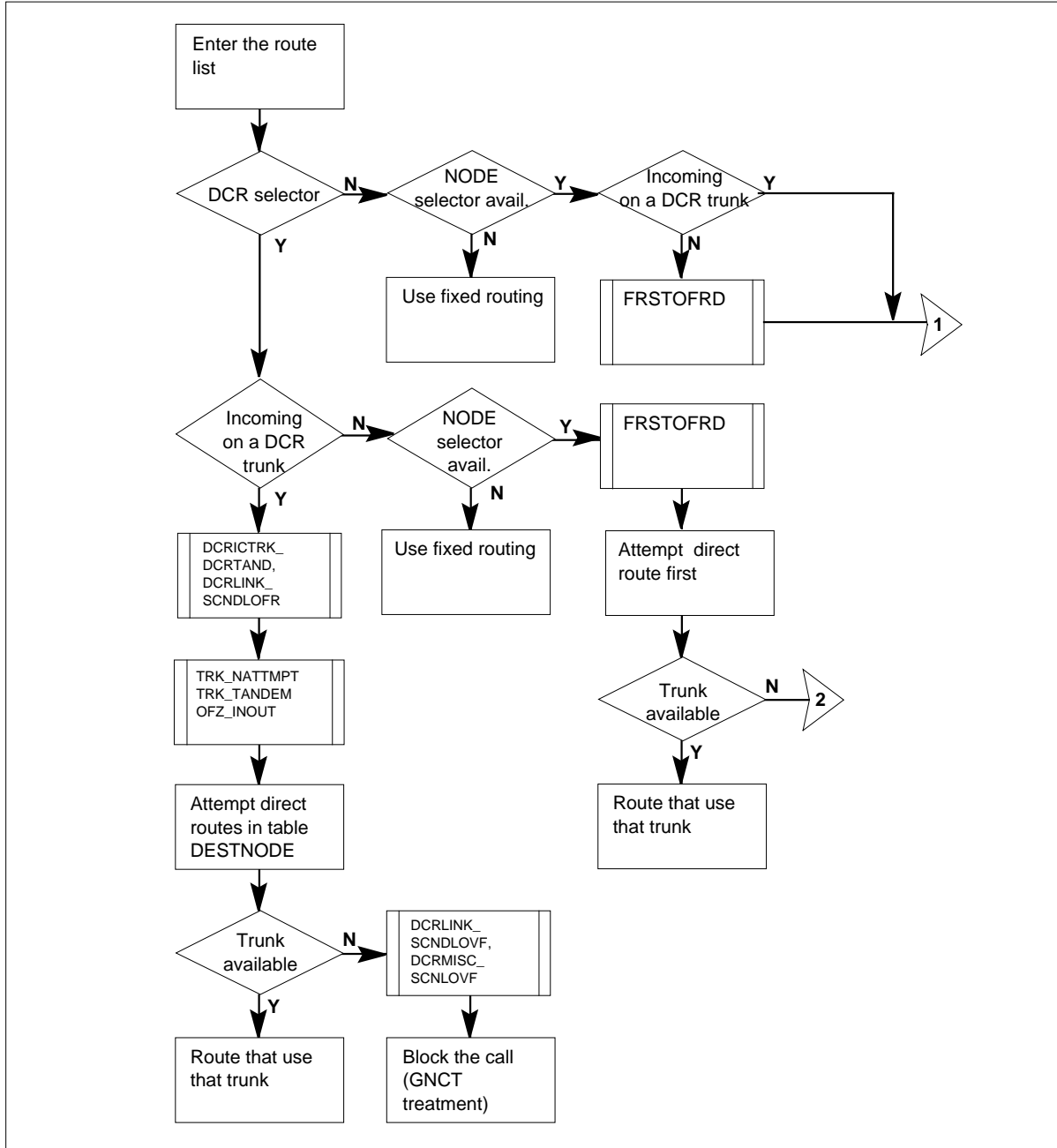

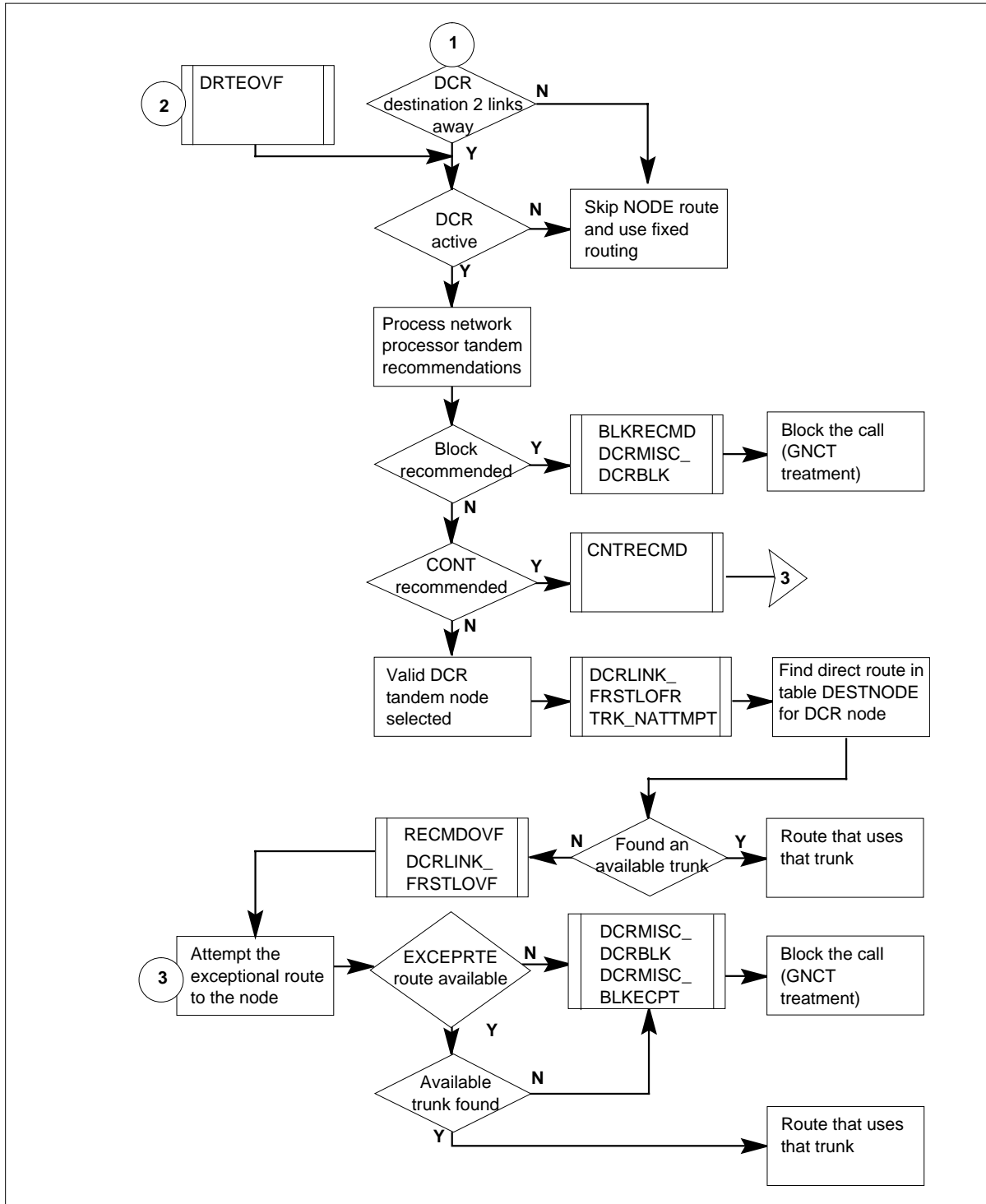
OM group DCRDEST (continued)**OM group DCRDEST registers**

OM group DCRDEST (continued)

Register BLKRECMD

NP block call recommendation

The BLKRECMD register counts DCR calls that the system blocks on the recommendation of the network processor (NP). The system routes these calls to generalized no-circuit treatment (GNCT).

Register BLKRECMD release history

BCS20

Register BLKRECMD was introduced before BCS20.

Associated registers

Register DCRMISC_DCRBLK counts DCR calls that the system blocks because of a BLOCK recommendation from the NP. This register also counts DCR calls that the system blocks in the exceptional route list.

Registers OFZ2 and SOTS provide information on the cause of the GNCT. These registers provide information for outgoing trunks or for the outgoing side of two-way trunks.

Associated logs

The system generates LOG138 if the system routes a call to a treatment after call processing determines that the line is busy.

The system generates LOG138 if the system routes a call to a treatment after call processing determines that the line is busy.

The system does not produce these logs if the system increases register BLKRECMD when the TRAVER command is used.

Register CNTRECMD

NP CONT call recommendation

Register CNTRECMD counts DCR calls that the system continues to route with the exceptional route on the recommendation of the network processor. The system routes these calls to the exceptional route list for the correct DCR destination.

Register CNTRECMD release history

OM group DCRDEST (continued)

BCS20

Register CNTRECMD was introduced before BCS20.

Associated registers

There are no associated registers.

Associated logs

There are no associated logs.

Register DRTEOVF

First offered DCR call overflows

Register DRTEOVF counts first-offered DCR calls that overflow from the direct link. The direct link consists of the direct routes from the originating switch to the DCR destination switch. If the DCR is turned on in the switch, calls that this register counts follow the NP tandem recommendation.

Register DRTEOVF release history**BCS20**

Register DRTEOVF was introduced before BCS20.

Associated registers

Register TRK_NOVFLATB counts calls that overflow a trunk group and that the system routes forward because an idle trunk is not available.

Associated logs

There are no associated logs.

Register FRSTOFRD

First offered DCR calls

Register FRSTOFRD counts first-offered DCR calls. First-offered DCR calls originate at a one toll switch and are to go to another toll switch. The calls continue toward another toll switch. The number of DCR links between the switches does not determine if the calls continue.

The FRSTOFRD register continues to keep a total, if the DCR routing is or is not deactivated.

Register FRSTOFRD release history

Register FRSTOFRD was introduced before BCS20.

OM group DCRDEST (end)

Associated registers

Register TRK_NATTMPT counts outgoing calls that the system routes to the trunk group.

Associated logs

There are no associated logs.

Register RECMDOVF

NP recommended route overflows

Register RECMDOVF counts calls offered to a DCR tandem that overflow the first recommended tandem route. The DCR tandem traffic consists of calls that the path recommended by the network processor, serves. Traffic offered to a DCR tandem is incoming on DCR trunks, or fills from direct routes.

The system routes calls, that this register counts, to the exceptional route list for the correct DCIR destination. If an exceptional route list is not present, or trunks are not available, the system routes the calls to generalized no-treatment (GNCT).

RECMDOVF release history

Register RECMDOVF was introduced before BCS20.

Associated registers

Register DCRLINK_FRSTLOVF counts tandem DCR calls that overflow the first link of the two link recommended path.

Register TRK_NOVFLATB counts calls that overflow the trunk group, that the system forward because an idle trunk is not available.

Associated logs

There are no associated logs.

OM group DCRICTRK

OM description

Dynamically controlled routing incoming trunk

Register DCRICTRK provides measurements for Dynamically Controlled Routing (DCR) for each incoming trunk group.

Dynamically Controlled Routing is a feature that recommends tandem routes for toll calls that the system routes to an exact toll switch. This toll switch is one or two links away from the originating toll switch. A network processor (NP) computes other tandem routes, and recommends the best route.

At normal intervals, each switch with the DCR feature sends its trunk measurements to the NP. The NP recommends that calls for a DCR toll switch continue on the fixed route or go to another tandem route. The system can block the calls.

Register DCRICTRK is provided for all DMS-100 switches with the Dynamically Controlled Routing feature.

Release history

BCS20

The OM group DCRICTRK was introduced before BCS20.

Registers

The registers for OM group DCRICTRK appear on the MAP terminal as follows:



DCRTAND

Group structure

The OM group DCRICTRK provides one tuple for each trunk group.

Key field:

COMMON_LANGUAGE_NAME identifies all trunk groups in the switch. Register DCRICTRK includes incoming or two-way trunk groups you can enter in field TKKEY of table TKTONODE as DCR trunk groups. Enter a maximum of 2048 trunk groups as DCR trunk groups.

OM group DCRICTRK (continued)

Info field:

There is no info field.

Enter data in four tables: DESTKEY, DESTNODE, DCROPT, and TKTONODE.

Table DESTKEY stores all DCR destination, like destinations more than two DCR links away from the switch.

Table DESTNODE contains a tuple for every DCR destination that is one or two DCR links away from the switch.

The operating company uses Table DCROPT to control the modes of operation that the DCR package introduced.

Table TKTONODE lists the trunk group CLLIs of all incoming and two-way trunks used for DCR. This table also lists the CLLI of the originating office for each DCR trunk group

Associated OM groups

The OM group DCRDEST provides DCR measurements for each toll office destination.

The OM group DCRLINK provides DCR measurements for each toll link.

The OM group DCRMISC provides DCR measurements for each switch.

Associated functional groups

There are no associated functional groups.

Associated functionality codes

The functionality codes for OM group DCRICTRK appear in the following table.

Functionality	Code
Dynamically Controlled Routing	NTX022AA

OM group DCRICTRK (continued)

OM group DCRICTRK registers

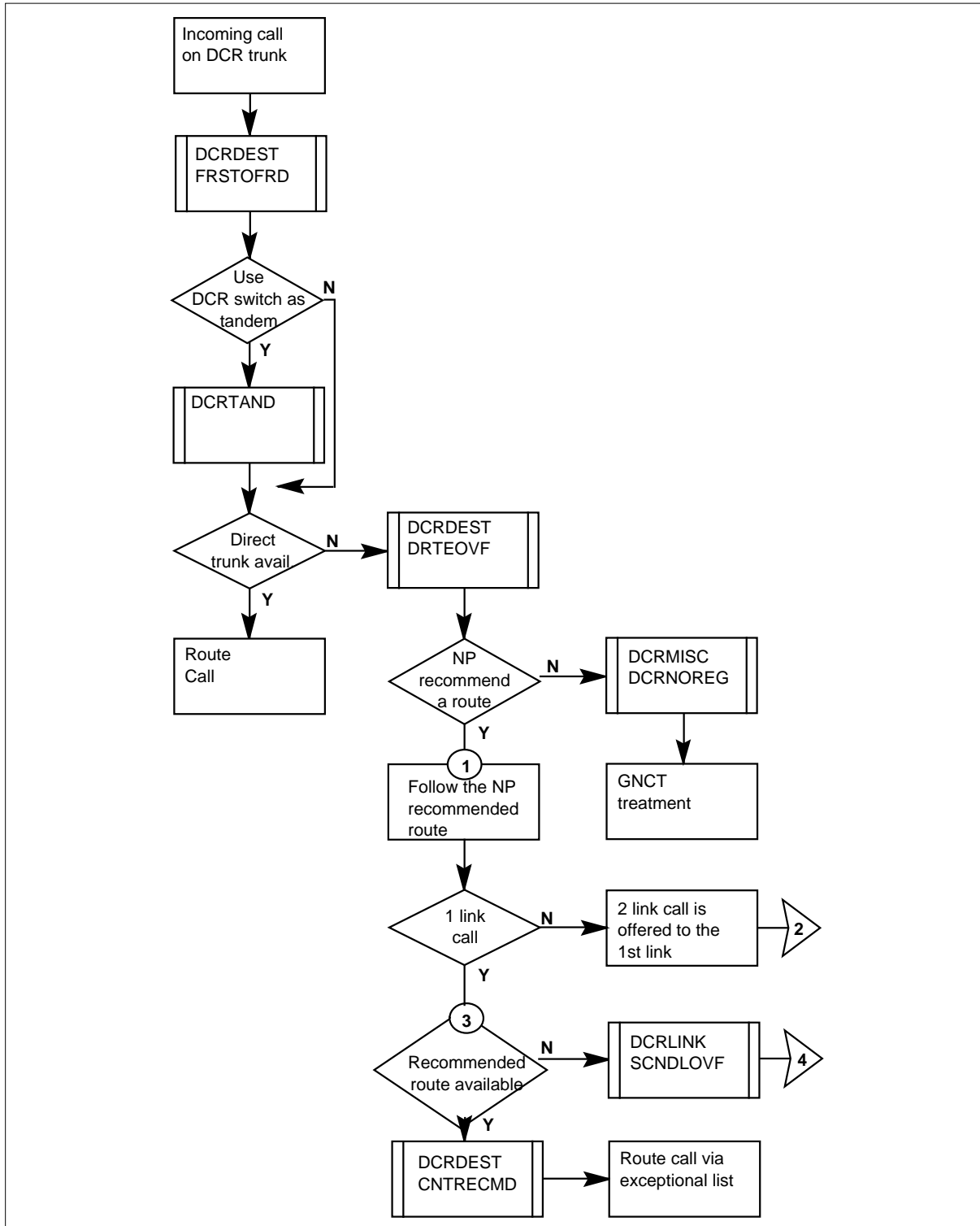

OM group DCRICTRK (continued)

OM group DCRICTRK registers

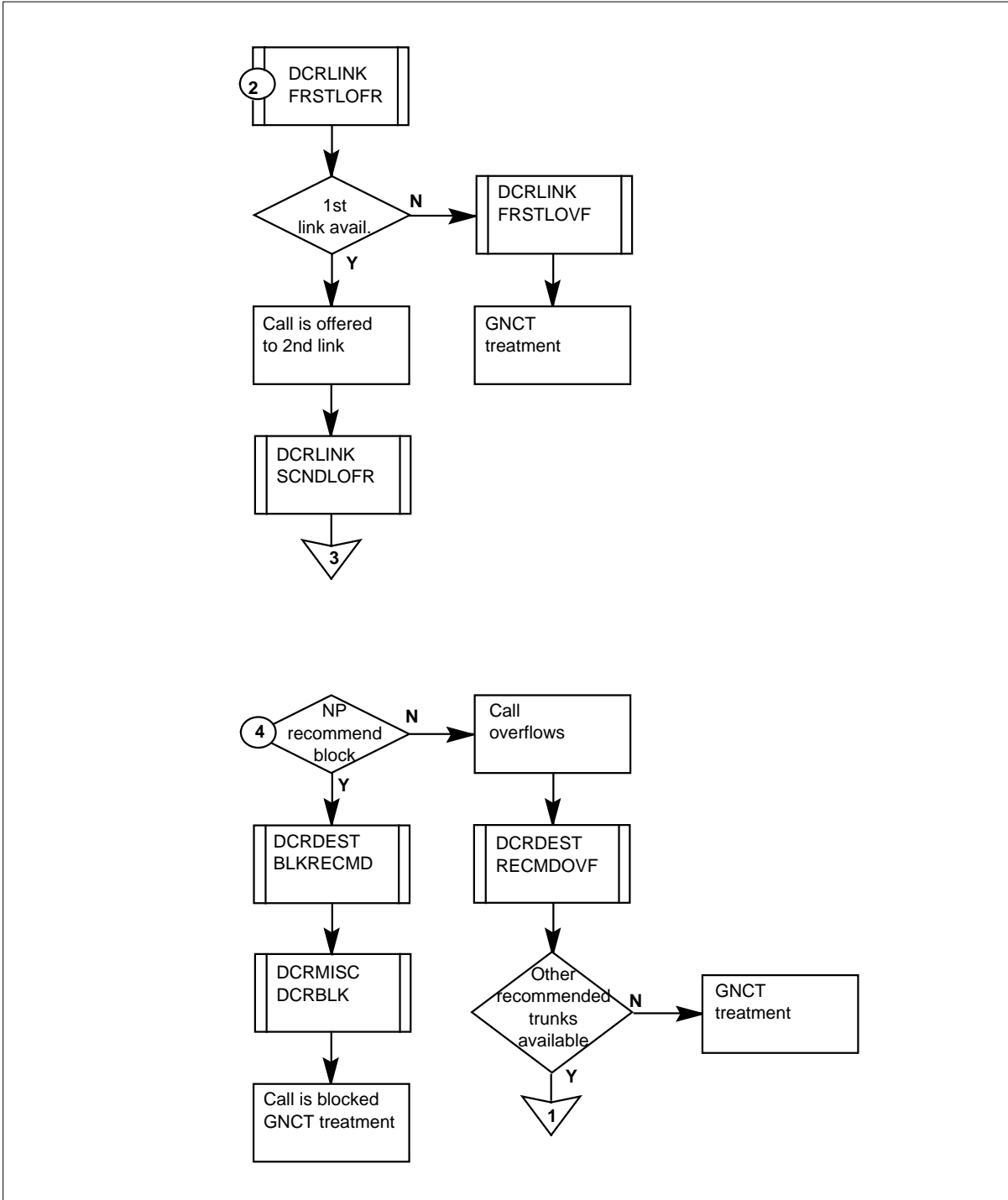

OM group DCRICTRK (end)

Register DCRTAND

Incoming dynamically controlled routing (DCR) tandem attempts

Register DCRTAND counts incoming DCR calls that attempt to use the DCR switch as a tandem office.

Register DCRTAND continues to count, when DCR routing is deactivated.

Register DCRTAND increases at the routing stage so that the register can use the CI command TRAVER (translation and routing verification). The system uses the CI command TRAVER with the no trace (NT) option.

Register DCRTAND release history

Register DCRTAND was introduced before BCS20.

Associated registers

Register TRK_NATTMPT counts outgoing calls that the system routes to the trunk group.

Register DCRLINK_SCNDLOFR counts tandem DCR calls that the register offers to the second link of the two-link recommended path.

Associated logs

There are no associated logs.

OM group DCRLINK

OM description

Dynamically Controlled Routing link status (DCRLINK)

The DCRLINK provides measurements for the Dynamically Controlled Routing (DCR) feature in each toll link.

The DCR feature provides tandem routes for toll calls. These toll calls are for a toll switch that is one or two links away from the originating toll switch. A network processor (NP) computes other possible tandem routes, and recommends the route that can succeed.

At normal intervals, each switch with the DCR feature sends the trunk measurements to the NP. The NP recommends a route for calls for a DCR toll switch.

The NP recommends one of the following routes:

- that the calls continue on the fixed route
- that the system route the calls to another tandem route
- that the system block the calls

Release history

the OM group DCRLINK was introduced before BCS20.

BCS36

The node names in table DESTNODE are the key names of the tuples of the OM increased registers.

BCS35

Key field changed to provide for 253 tuples.

Registers

the OM group DCRLINK registers appear on the MAP terminal as follows:

FRSTLOFR	SCNDLOFR	FRSTLOVF	SCNDLOVF
----------	----------	----------	----------

Group structure

the OM group DCRLINK provides one tuple for each DCR destination node name (maximum 253).

OM group DCRLINK (continued)

Key field:

The NETNAME\$DEST_NODE_NAME identifies the office names of the toll destinations that are accessible with toll links from the switch. The user assigns office names in field DESTKEY of table DESTKEY. The field contains only the destinations that are one link away from the switch.

Info field:

There is no info field.

The user must enter tables DESTKEY, DESTNODE, DCROPT, and TKTONODE.

Table DESTKEY stores all DCR destinations. These destinations include destinations that are more than two DCR links away from the switch.

Table DESTNODE contains a tuple for each DCR destination that is one or two DCR links away from the switch.

The operating company uses table DCROPT to control modes of operation that the DCR package introduces.

Table TKTONODE lists the trunk group common language location identifiers (CLLI) of all incoming and two-way trunks that DCR uses. Table TKTONODE lists the CLLI of the originating office from which the trunk group comes.

Associated OM groups

The DCRICTRK provides DCR measurements for each incoming trunk group.

The DCRDEST provides DCR measurements for each toll office destination.

The DCRMISC provides DCR measurements for each switch.

OM group DCRLINK (continued)

Associated functional groups

The following functional group associates with the OM group DCRLINK:

- All DMS-100 switches with the DCR feature have the DCRLINK.

Associated functionality codes

The associated functionality codes for the OM group DCRLINK appear in the following table.

Functionality	Code
Dynamically Controlled Routing	NTX022AA
Dynamically Controlled Routing	NTX022AB

OM group DCRLINK (continued)

the OM group DCRLINK registers

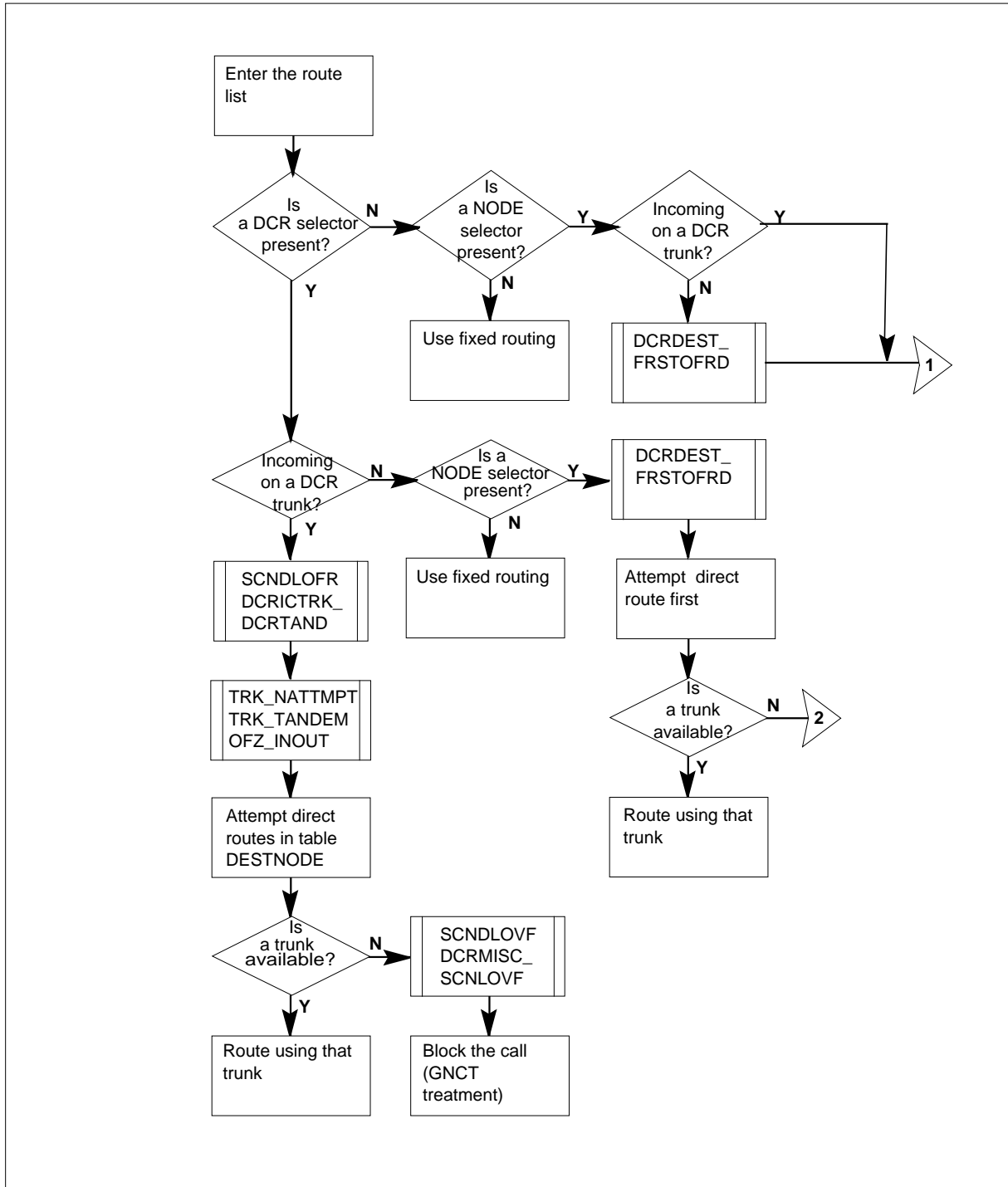

OM group DCRLINK (continued)

the OM group DCRLINK registers (end)

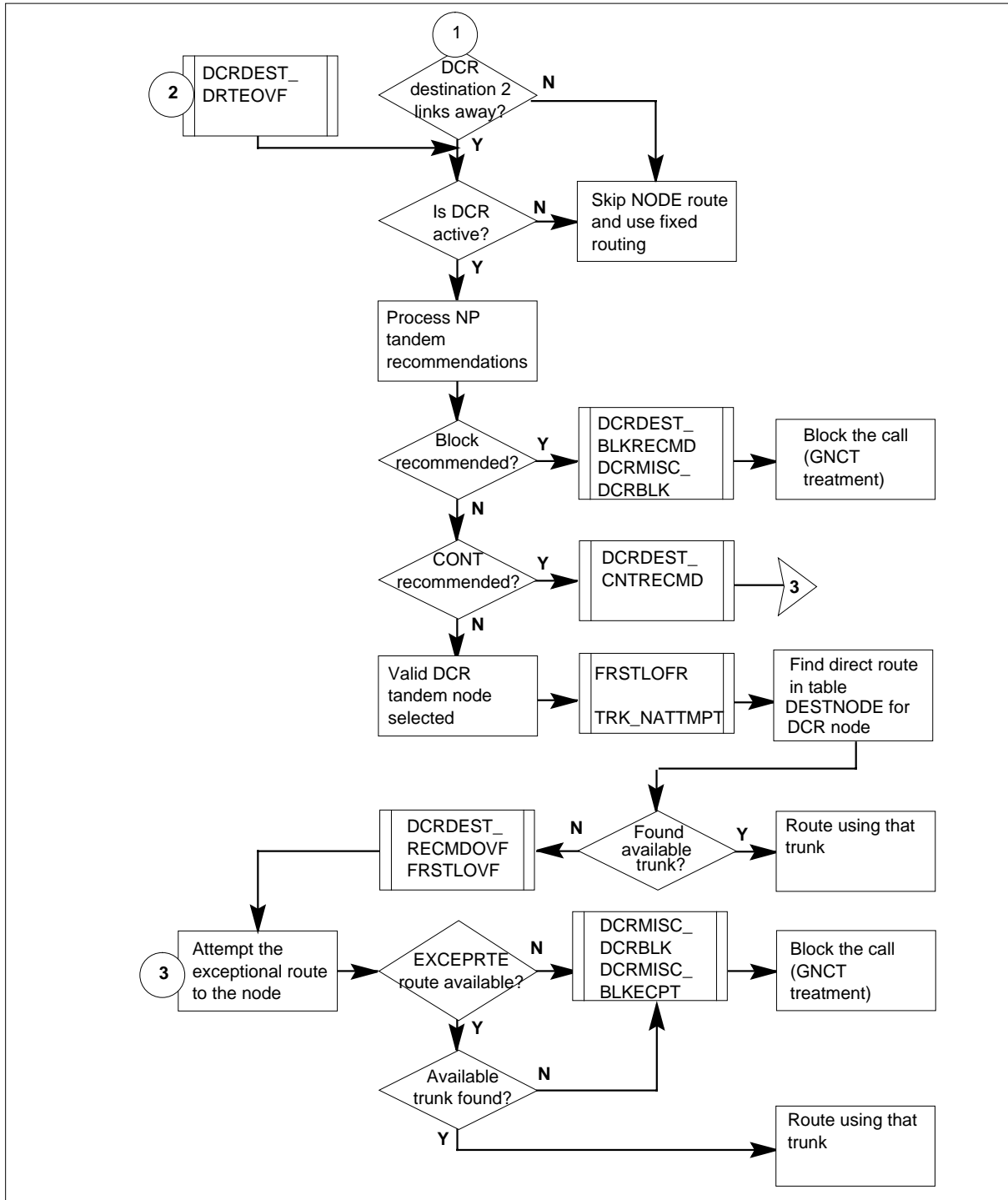

OM group DCRLINK (continued)

Register FRSTLOFR

First link offered DCR calls (FRSTLOFR)

Register FRSTLOFR counts tandem DCR calls that the system offers to the first link of a two-link recommended path. This register increases when the system routes a call to a correct DCR tandem route. The subsystem routes the call to the DCR tandem route if the route is or is not available.

Register FRSTLOFR release history

Register FRSTLOFR was introduced before BCS20.

Associated registers

Register TRK_NATTMPT counts outgoing calls that the system routes to the trunk group.

Associated logs

There are no associated logs.

Register FRSTLOVF

First link offered DCR call overflows (FRSTLOVF)

Register FRSTLOVF counts tandem DCR calls that overflow the first link of a two-link recommended path. The system routes these calls to the special route list for the correct DCR destination. If there is no special route list or there are no trunks available, the system routes the call to generalized no-circuit treatment (GNCT).

Register FRSTLOVF release history

Register FRSTLOVF was introduced before BCS20.

Register Associated registers

Register DCRDEST_RECMDOVF counts DCR calls that overflow the first recommended tandem route.

Register TRK_NOVFLATB counts calls that overflow a trunk group. The system reroutes these calls because an idle trunk is not available.

Registers OFZ2 and SOTS provide information on the cause of the GNCT for outgoing trunks or the outgoing side of two-way trunks.

Associated logs

There are no associated logs.

OM group DCRLINK (continued)

Register SCNDLOFR

Second link offered DCR calls (SCNDLOFR)

Register SCNDLOFR counts tandem DCR calls that the system offers as the second link of a two-link recommended path.

Register SCNDLOFR continues to count when DCR deactivates.

Register SCNDLOFR increases at the routing stage. As a result, the SCNDLOFR can increase. It increases when the user uses CI command TRAVER (translation and routing verification) with the no-trace (NT) option.

Register SCNDLOFR release history

Register SCNDLOFR was introduced before BCS20.

Associated registers

Register TRK_NATTMPT counts outgoing calls that the system routes to the trunk group.

Register DCRICTRK_DCRTAND counts incoming calls that attempt to use the DCR switch as a tandem office.

Associated logs

There are no associated logs.

Register SCNDLOVF

Second link offered DCR call overflows (SCNDLOVF)

Register SCNDLOVF counts tandem DCR calls that overflow the second link of a two-link recommended path. The system routes these calls to generalized no-circuit treatment(GNCT).

Register SCNDLOVF continues to count when DCR deactivates.

Register SCNDLOVF release history

Register SCNDLOVF was introduced before BCS20.

Associated registers

Register TRK_NOVFLATB counts calls that overflow the trunk group. The system reroutes these calls because an idle trunk is not available.

Registers OFZ2 and SOTS provide information on the cause of GNCT for outgoing trunks or the outgoing side of two-way trunks.

OM group DCRLINK (end)

Associated logs

The system generates LINE138 if the system routes a call to a treatment because the line is call processing busy.

The system generates TRK138 if the system routes a call to a treatment because the trunk is call processing busy.

If SCNDLOVF increases because the operating company used the TRAVER command, the system does not generate these logs.

OM group DCRMISC

OM description

Dynamically Controlled Routing miscellaneous (DCRMISC)

The DCRMISC provides measurements for switches that use the Dynamically Controlled Routing (DCR) feature.

The DCR feature provides tandem routes for toll calls for a toll switch. The DCR provides routes for calls for a toll switch that is one or two links away from the originating toll switch. A network processor (NP) computes other possible tandem routes, and recommends the route that can succeed.

At equal intervals, each switch with the DCR feature sends the trunk measurements to the NP. The NP recommends specified routes for calls for a DCR toll switch.

The NP recommends the following action:

- the calls continue on the fixed route
- the calls route to a different tandem route
- the system block the calls

all DMS-100 switches with the DCR feature have the DCRMISC.

Release history

The OM group DCRMISC was introduced before BCS20.

CSP02

Registers MANSWTCH and AUTSWTCH were introduced.

BCS36

Table node names in table DCRNETID appear as the keys to the tuples of the OM-increase registers.

BCS35

The key field changed to provide six tuples.

BCS27

Registers BLKECPT and SCNLOVF were introduced in BCS27.

BCS22

Registers DCRNOREC and DCRBDREC were introduced in BCS22.

OM group DCRMISC (continued)

Registers

The following OM group DCRMISC registers appear on the MAP terminal as follows:

DCRBLK	DCRNOREC	DCRBDREC	BLKECPT
SCNLOVF	MANSWTCH	AUTSWTCH	

Group structure

The OM group DCRMISC provides six tuples, one for each office.

Key field:

NETNAME

Info field:

There is no info field

The user must enter tables DESTKEY, DESTNODE, DCROPT and TKTONODE.

Table DESTKEY stores all DCR destinations. These destinations can be destinations that are more than two DCR links away from the switch.

Table DESTNODE contains a tuple for every DCR destination that is one or two DCR links away from the switch.

The operating company uses DCROPT to control the different modes of operation the DCR package introduces.

Table TKTONODE lists the trunk group common language location identifiers (CLLI). Table TKTONODE lists the CLLI of all incoming and two-way trunks considered to be DCR trunks. For each DCR trunk group, the table lists the CLLI of the office from which the trunk group is incoming.

Associated OM groups

Other DCR OM groups are:

- The DCRDEST provides DCR measurements for each toll office destination.
- The DCRICTRK provides DCR measurements for each incoming trunk group.
- The DCRLINK provides DCR measurements for each toll link.

OM group DCRMISC (continued)

Associated functional groups

All DMS-100 switches with the DCR feature associate with OM group DCRMISC.

Associated functionality codes

The functionality codes associated with OM group DCRMISC appear in the following table.

Functionality	Code
Dynamically Controlled Routing (DCR/HPR)	NTX022AA
Dynamically Controlled Routing (upgrade)	NTX022AB

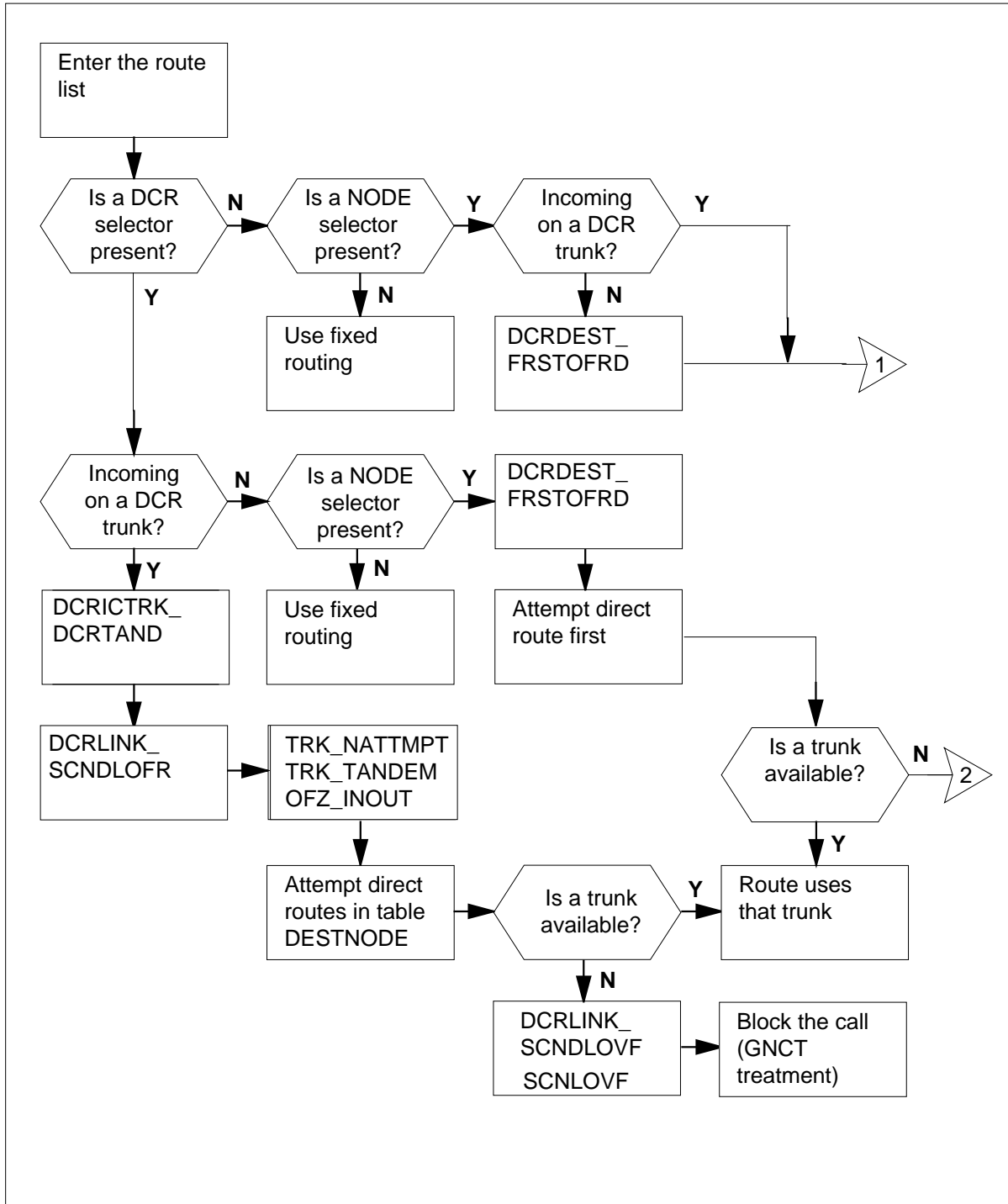
OM group DCRMISC (continued)**OM group DCRMISC registers**

OM group DCRMISC (continued)

OM group DCRMISC registers (continued)

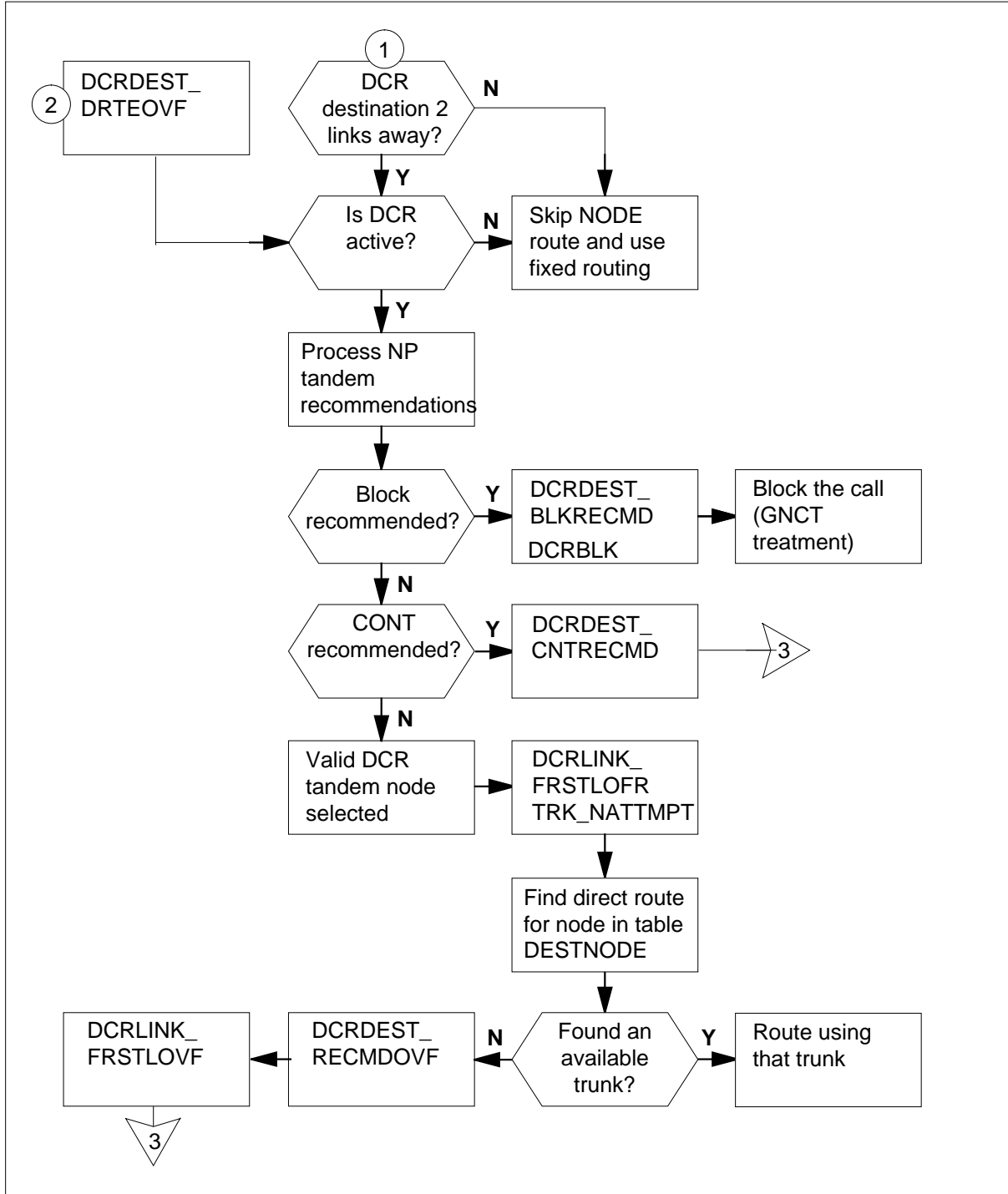

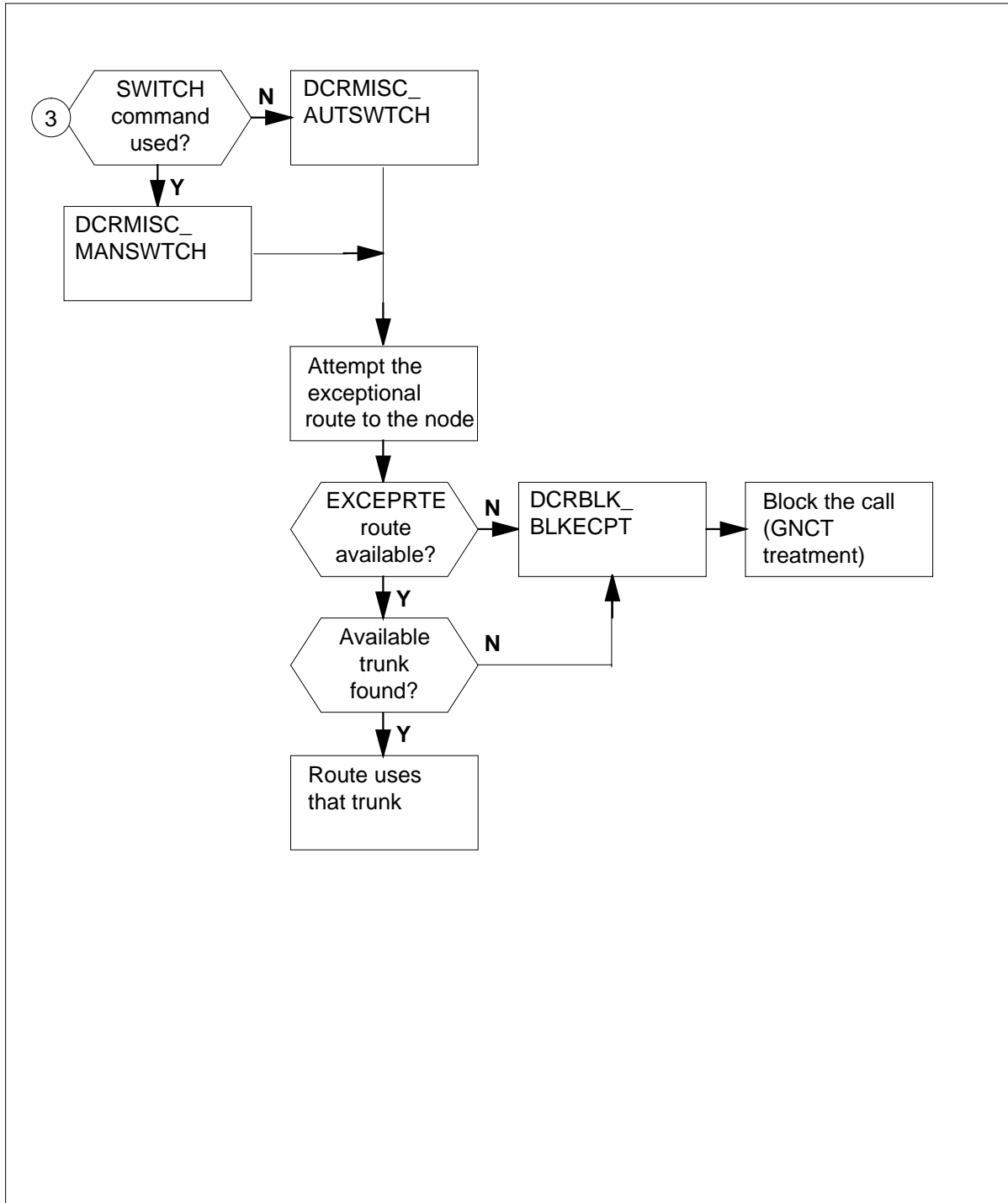
OM group DCRMISC (continued)**OM group DCRMISC registers (end)**

OM group DCRMISC (continued)

Register BLKECPT

Blocked Dynamically Controlled Routing calls attempting exceptional routes (BLKECPT)

Register BLKECPT counts DCR calls that the system blocks after the calls attempt DCR exceptional routes. The system blocks the calls because trunks are not available. The system can block the calls when DCR exceptional routes datafill is not present.

Register BLKECPT release history

Register BLKECPT was introduced in BCS27.

Associated registers

Register DCRBLK includes calls that the system counts in BLKECPT.

Associated logs

There are no associated logs.

Register DCRBDREC

Bad network processor recommendations (DCRBDREC)

Register DCRBDREC counts invalid recommendation packets that the network processor sends to the DMS switch. The Network processor sends the recommendation packets to the DMS switch because of sanity failures or transmission errors. The system ignores the invalid recommendations. The system uses the recommendations from the previous reporting cycle to route calls.

Register DCRBDREC release history

Register DCRBDREC was introduced in BCS22.

Associated registers

There are no associated registers.

Associated logs

There are no associated logs.

Register DCRBLK

DCR blocked calls (DCRBLK)

Register DCRBLK counts DCR calls that the system blocks because of a block recommendation from the network processor. The DCRBLK counts calls that the system blocks in the exceptional route list. The system blocks calls in the

OM group DCRMISC (continued)

exceptional route list because trunks are not available, or because the route list is empty.

Register DCRBLK release history

Register DCRBLK was introduced before BCS20.

Associated registers

Register DCRDEST_BLKRECMD counts DCR calls that the system blocks on the recommendation of the NP.

Associated logs

The system generates LINE138 if the system routes a call to a treatment because the line is call processing busy.

The system generates TRK138 if the system routes a call to a treatment because the trunk is call processing busy.

The system does not produce these logs if the user increments DCRBLK with the TRAVER command.

Register DCRNOREC

No network processor (NP) recommendation (DCRNOREC)

Register DCRNOREC counts reporting cycles when the NP does not make a recommendation. The NP does not make a recommendation because of a loss of communication between the switch and the NP. A failure in the NP causes loss of communication. A failure in the link between the DMS switch and the NP can cause loss of communication.

Register DCRNOREC release history

Register DCRNOREC was introduced in BCS22.

Associated registers

There are no associated logs.

Associated logs

There are no associated logs.

Register SCNLOVF

Second link overflow (SCNLOVF)

OM group DCRMISC (continued)

Register SCNLOVF counts tandem DCR calls that overflow the second link of a two-link recommended path. The system routes these calls to generalized no-circuit (GNCT) treatment.

Register SCNLOVF counts calls when the system deactivates DCR routing.

Register SCNLOVF release history

Register SCNLOVF was introduced in BCS27.

Associated registers

Register DCRLINK_SCNDLOVF counts tandem DCR calls that overflow the second link of a two-link recommended path for each DCR link.

Associated logs

The system generates LINE138 when the system routes a call to a treatment after the call is processing busy.

The system generates TRK138 when the system routes a call to a treatment after the call is processing busy.

Register MANSWTCH

Manual switch over (MANSWTCH)

Register MANSWTCH measures the number of times that a DCR network switches communication from an active link to a standby link. The DCR network switches communication because of the DCRUTIL CI command SWITCH.

Register MANSWTCH release history

Register MANSWTCH was introduced in BCS37.

Associated registers

There are no associated registers.

Associated logs

The system generates log number DCR107 when the MANSWTCH register increases.

Extension registers

There are no extension registers.

Register AUTSWTCH

Automatic switch over (AUTSWTCH)

OM group DCRMISC (end)

Register AUTSWTCH measures the number of times that a DCR network switches communication from an active link to a standby link. This action occurs for reasons other than the use of the DCRUTIL CI command SWITCH.

Register AUTSWTCH release history

Register AUTSWTCH was introduced in BCS37.

Associated registers

There are no associated registers.

Associated logs

The system generates log number DCR107 when the AUTSWTCH register increases.

Extension registers

There are no extension registers.

OM group DDU

OM description

Disk drive unit file and maintenance work (DDU)

Register DDU provides information on disk drive units (DDU). A DDU is an external storage device in an I/O equipment frame.

Two peg registers count errors and faults that the system detects in DDUs. Two usage registers record if DDUs are manual or system busy.

The system uses data provided by DDU to monitor the performance of DDUs.

Release history

The OM group DDU was introduced before BCS20.

BCS33

When you set office parameters DDUMBUSY and DDUSBUSY, you convert hundred call seconds (CCS) to deci-erlangs before the CCS appears. Use the OMSHOW command on the ACTIVE class to display the CCS. The value in the active register remains in CCS.

BCS30

Software changed for the OM group DDU provide use counts in CCS or deci-erlangs.

Registers

The OM group DDU registers appear on the MAP terminal as follows:



DDUERROR DDUFAULT DDUMBUSY DDUSBUSY

Group structure

The OM group DDU provides one tuple for each office.

Key field:

There is no Key field

Info field:

There is no Info field

Associated OM groups

There are no associated OM groups.

OM group DDU (continued)

Associated operating groups

The following operating groups associate with OM group DDU:

- DMS-100 Local
- DMS-200 Toll
- DMS-250 Toll/Tandem
- DMS-300 Gateway
- DMS International
- DMS-MTX

Associated functionality codes

The associated functionality codes for the OM group DDU appear in the following table.

Functionality	Code
Common Basic	NTX001AA
International Switching Center-Basic	NTX300AA

OM group DDU (continued)

OM group DDU registers

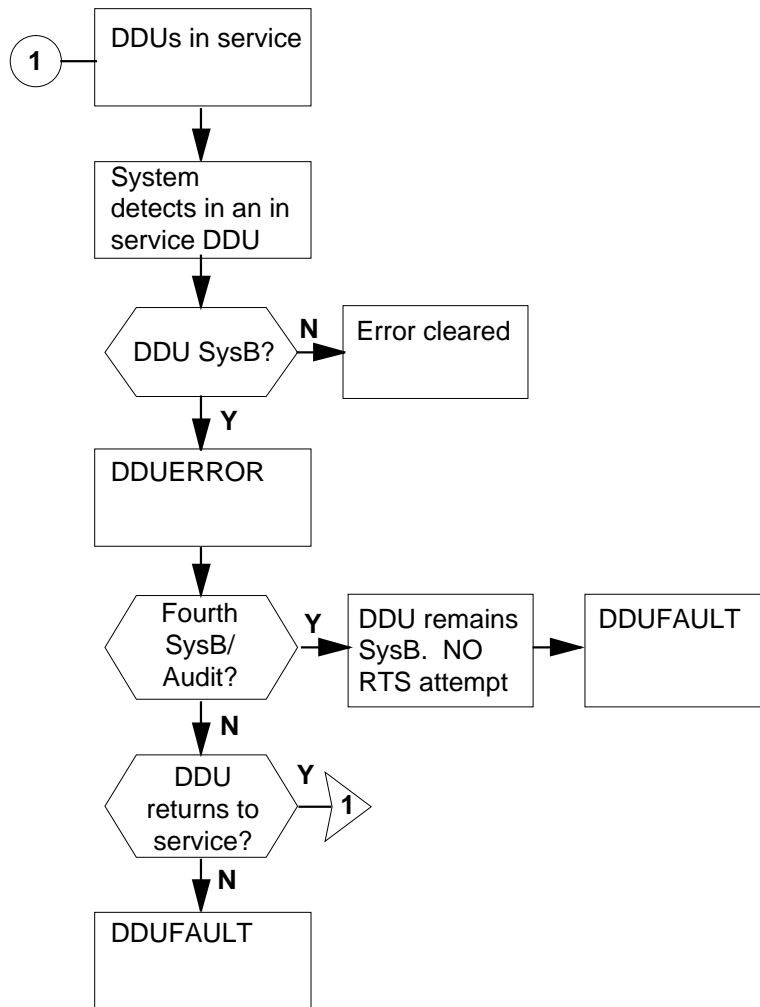

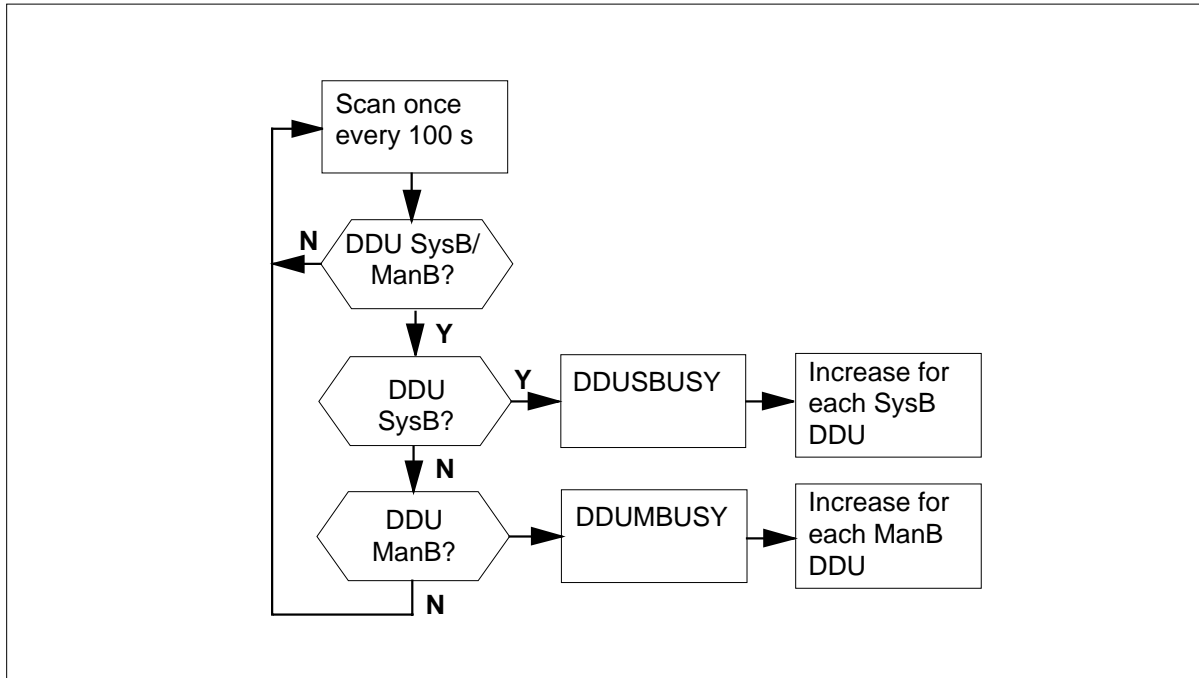
OM group DDU (continued)**OM group DDUUsage registers****Register DDUERROR**

DDU errors (DDUERROR)

Register DDUERROR counts I/O errors that cause an in-service DDU to become system busy. Register DDUERROR counts:

- temporary errors that cause the DDU to become temporarily system busy
- faults that cause the DDU to remain system busy until an action corrects the fault

Register DDUERROR release history

Register DDUERROR was introduced before BCS20.

Associated registers

Register DDUFAULT counts system attempts to return to service a failed DDU.

Associated logs

The system generates DDU100 when DDU initialization is complete or software errors prevent DDU initialization.

The system generates DDU101 when the system detects I/O errors in a DDU.

OM group DDU (continued)

The system generates DDU204 when a DDU becomes system busy.

The system generates DDU205 when an attempt to return to service a DDU occurs.

The system generates IOGA101 when the I/O error handler processes a message-related fault report.

Register DDUFAULT

DDU fault (DDUFAULT)

Register DDUFAULT increases if either of the following events occurs:

- the system makes an attempt to return to service a DDU that fails after an error makes the DDU system busy
- the system makes a DDU system busy four times in a single audit cycle and the DDU remains system busy

Register DDUFAULT release history

Register DDUFAULT was introduced before BCS20.

Associated registers

Register DDU_DDUERROR counts input or output errors that make an in-service DDU system busy.

Associated logs

The system generates DDU204 when a DDU becomes system busy.

The system generates DDU205 when an attempt to return to service a DDU occurs.

The system generates DDU208 when the I/O subsystem reports that a sanity time-out occurs on a DDU.

The system generates DDU209 when a DDU becomes C-side busy because a C-side node changes state.

The system generates DDU212 when a DDU fails a system or manually initiated diagnostic.

Register DDUMBUSY

DDU manual busy usage (DDUMBUSY)

OM group DDU (continued)

Register DDUMBUSY is a usage register. The scan rate 100 s. Register DDUMBUSY increases each time the system detects a manual busy DDU.

Register DDUMBUSY release history

Register DDUMBUSY was introduced before BCS20.

BCS33

When you set office parameter OMINERLANGS to Y, you convert the usage count from CCS to deci-erlangs before the count appears. Use the OMSHOW command on the ACTIVE class to convert the usage count. The value in the active registers remains in CCS.

BCS30

Software changed for register DDUMBUSY in BCS30 to provide use counts in CCS or in deci-erlangs.

Associated registers

There are no associated registers.

Associated logs

The system generates DDU203 when you attempt to make a DDU manual busy.

Register DDUSBUSY

DDU system busy usage (DDUSBUSY)

Register DDUSBUSY is a usage register. The scan rate is slow 100 s. Register DDUSBUSY increases each time the system detects a system busy DDU.

DDUSBUSY release history

Register DDUSBUSY was introduced before BCS20.

BCS33

When you set office parameter OMINERLANGS to Y, you convert the usage count from CCS to deci-erlangs before the count appears. Use the OMSHOW command on the ACTIVE class to display the usage count. The value in the active registers remains in CCS.

BCS30

Software changed for register DDUSBUSY in BCS30 provide usage counts either in CCS or in deci-erlangs.

Associated registers

There are no associated registers.

OM group DDU (end)

Associated logs

The system generates DDU204 when a DDU becomes system busy.

OM group DRM

Om description

Distributed Record Manager

DRM operational measurements (OM) track the number of application records, blocks of records written to disk, and the number of file rotations.

Release history

OM group DRM was introduced in BCS34.

Registers

OM group DRM registers display as follows:

RECORDS1	RECORDS2	BLOCKS1	ROTATES
----------	----------	---------	---------

Group structure

OM group DRM provides 32 tuples per office.

Key field:

OMDRMAPPLNAMESR

Info field:

None

Associated OM groups

None

Associated products

Billing Server

Register RECORDS

RECORDS counts the number of individual DRM application records written into a block. A block contains records grouped together to be written to disk. As an application requests DRM to write a block to disk, it will also pass DRM a count of the application records in that block. The number of records is not used by DRM except to add to the RECORDS register.

OM group DRM (end)

Register RECORDS release history

Register RECORDS was introduced in BCS34.

Associated registers

RECORDS is associated with BLOCKS because it increases by n as BLOCKS increases (for example, each time a BLOCK is incremented, the count of application records within the block also increases).

Extension register

RECORDS2

Register BLOCKS

BLOCKS counts the number of blocks DRM is given to write to disk. The block size is dictated by the DRM application. A block is a collection of one or more application records.

Register BLOCKS release history

Register BLOCKS was introduced in BCS34.

Associated registers

BLOCKS is associated with RECORDS because it increases by n as RECORDS increases.

Register ROTATES

ROTATES counts the number of new files opened.

Register ROTATES release history

Register ROTATES was introduced in BCS34.

OM group DS1CARR

OM description

DS-1 digital carrier maintenance summary (DS1CARR)

The OM group DS1CARR provides information about maintenance thresholds and out-of-service (OOS) thresholds. This OM group provides this information for digital trunks on digital peripheral modules (PM). When the DS-1 exceeds OOS thresholds, the system removes the DS-1 from service until the DS-1 is manually returned to service. Trunks on the DS-1 carrier are set to the carrier fail state. You can set each DS-1 carrier to NOT TO BE REMOVED or leave the DS-1 carrier alone. You perform this procedure when the DS-1 carrier reaches the OOS threshold. If you set the DS-1 carrier to NOT TO BE REMOVED, the system only generates a log. The CARRIER level of the MAP terminal displays this information on the DS-1 carrier.

For remote line module (RLM) or line concentrating module (LCM) link errors, the OM group DS1CARR provides monitoring for the:

- central control (CC) or host end
- remote end of a DS-1 carrier, except for the following registers:
 - DS1SBU
 - DS1MBU
 - DS1PBU
 - DS1CBU

The system reports one set of registers for each carrier port of each digital PM.

If a carrier system is busy, all trunks that the carrier system serves change to the carrier fail state. Register TRK_SBU records system busy use for each trunk group.

Maintenance thresholds are 1 bit in 107 for bit error rate, 17 accumulated losses of frame, or 4 accumulated slips.

The OOS thresholds are 1 bit in 103 for bit error rate, 511 accumulated losses of frame, or 255 accumulated slips. A carrier that becomes busy because of bit error must wait to return to service. The carrier cannot return to service until the measured long-term rate of the system drops below 1 bit in 105.

Release history

The OM group DS1CARR was introduced before BCS20.

OM group DS1CARR (continued)

BCS33

Number of tuples in the OM group DS1CARR increases. The increase allows the addition of the compact remote cluster controller (RCC2). The increase also allows the addition of the direct fiber interface (DFI)-type compact peripheral module measurement.

BCS32

The OM group DS1CARR expanded to include the DS-1 links associated with subscriber carrier module (SCM) access node type PM. The DFI and RCC2 were introduced to the information field description.

BCS31

The PM type FRIU was introduced to the DS1OMINFO field. Registers DS1SLP and DS1PBU are always zero for PM type FRIU.

BCS30

Software changed to provide use counts in CCS or deci-erlangs.

BCS29

Register DS1ECF was introduced.

BCS25

Register DS1BPV was deleted.

BCS24

Register DS1BPV was set to zero, and registers DS1BER, DS1ES, DS1SES, DS1UAS and DS1AIS were introduced.

Registers

The OM group DS1CARR registers appear on the MAP terminal as follows:

DS1LCGA	DS1RCGA	DS1LOF	DS1SLP
DS1SBU	DS1MBU	DS1PBU	DS1CBU
DS1BER	DS1ES	DS1SES	DS1UAS
DS1AIS	DS1ECF		

Group structure

The OM group DS1CARR provides one tuple for each DS-1 carrier on the host peripheral. This OM group also provides two tuples for each remote control cluster (RCC). One tuple is for the carrier on the P-side and one tuple is for the carrier on the C-side.

OM group DS1CARR (continued)

Key field:

There is no key field.

Info field:

The DS1OMINF information field identifies a terminal on a given digital PM.

The information field contains the following:

- site of the PM
- PM type
- external PM sequence number
- DS-1 carrier number (0 to 19) in the PM
- carrier direction (C or P). The carrier direction indicates if the PM port is on the central side (C-side) or peripheral side (P-side) of the carrier.

Associated OM groups

There are no associated OM groups.

Associated functional groups

The following operating groups associate with the OM group DS1CARR:

- RLM
- LCM

Associated functionality codes

The associated functionality codes for OM group DS1CARR appear in the following table.

Functionality	Code
Common Basic	NTX001AA
Frame Relay Basic	NTXF25AA
CNS Integrated Echo Cancellor	NTXG24AA

OM group DS1CARR (continued)

OM group DS1CARR registers

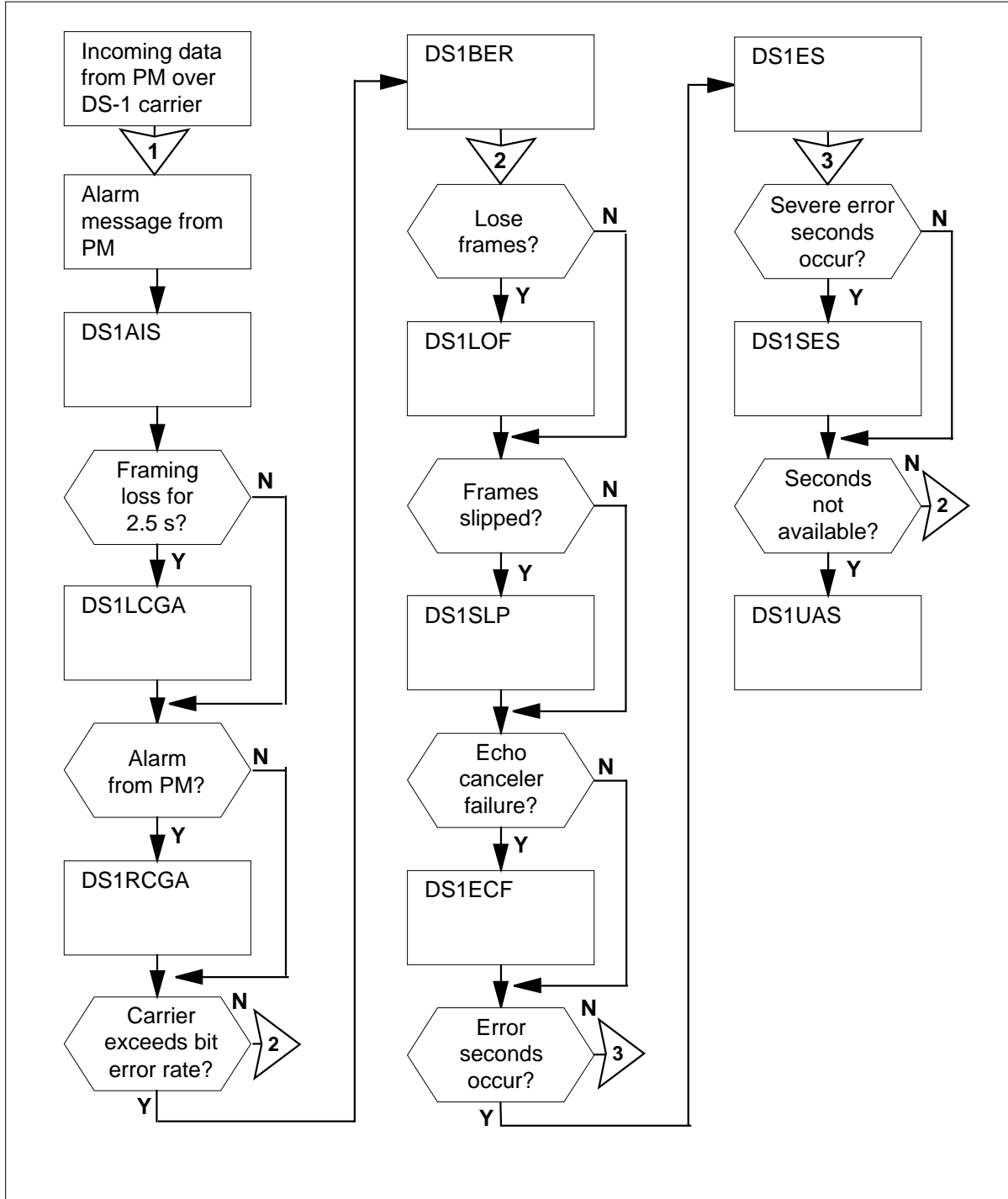

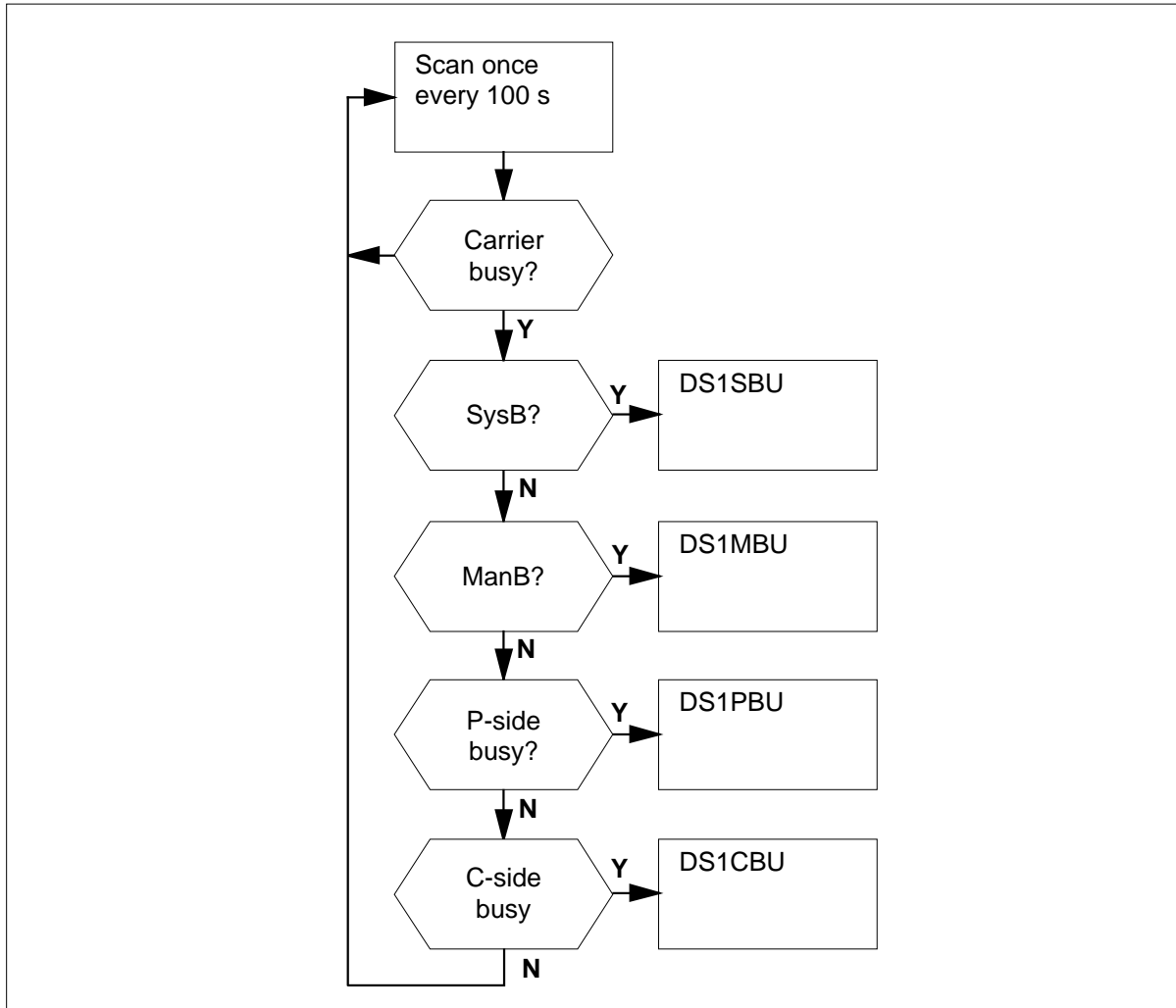
OM group DS1CARR (continued)**OM group DS1CARR usage registers****Register DS1AIS**

DS-1 alarm indication signals (DS1AIS)

Register DS1AIS counts messages the system receives from the PM and indicates that the PM receives an alarm indication signal.

Register DS1AIS release history

Register DS1AIS was introduced in BCS24.

Associated registers

There are no associated registers.

OM group DS1CARR (continued)

Associated logs

There are no associated logs.

Register DS1BER

DS-1 bit error rate (DS1BER)

Register DS1BER counts messages that the system receives from the PM. The messages indicate that the bit error rate exceeds maintenance or OOS thresholds.

Register DS1BER release history

Register DS1BER was introduced in BCS24.

Associated registers

Information in DS1BPV before BCS24 is now in register DS1BER.

Associated logs

There are no associated logs.

Register DS1CBU

C-side busy usage (DS1CBU)

Register DS1CBU is a usage register. The scan rate is 100 s. Register DS1CBU records if the DS-1 carrier is C-side busy. The DS-1 carrier is C-side busy because the C-side PM of the carrier is OOS.

Register DS1CBU release history

Register DS1CBU was introduced before BCS20.

BCS30

Software changed to provide use counts in CCS or deci-erlangs.

Associated registers

There are no associated registers.

Associated logs

The PM subsystem generates PM107 when a PM changes state to C-side busy because of a system request.

Register DS1ECF

DS-1 echo canceller failure (DS1ECF)

OM group DS1CARR (continued)

Register DS1ECF counts the number of echo canceller failures in the DS-1 carrier during a 10 min audit cycle.

Register DS1ECF release history

Register DS1ECF was introduced in BCS29.

Associated registers

There are no associated registers.

Associated logs

The trunk maintenance subsystem generates TRK109 when a test on a DS-1 fails.

Register DS1ES

DS-1 error seconds (DS1ES)

Register DS1ES counts DS-1 error seconds during XMS-based peripheral module (XPM) audits. Table CARRMTC identifies error second thresholds.

Register DS1ES release history

Register DS1ES was introduced in BCS24.

BCS28

Software changed to include counts for remote cluster controller central side (C-side) carriers.

Associated registers

There are no associated registers.

Associated logs

There are no associated logs.

Register DS1LCGA

Local carrier group alarm (DS1LCGA)

Register DS1LCGA increases when the system receives a local carrier group alarm message from the PM.

The system reports a local carrier group alarm when the system loses framing on incoming data for 2.5 s. The alarm clears when the system regains framing for 10 s. While the alarm is active, the CC maintains the carrier system as system busy.

OM group DS1CARR (continued)

DS1LCGA release history

Register DS1LCGA was introduced in BCS20.

Associated registers

There are no associated registers.

Associated logs

The PM subsystem generates PM 109 when a T1 carrier becomes system busy.

The trunk maintenance subsystem generates PM109 when a test on a DS-1 fails.

Register DS1LOF

Loss of frame (DS1LOF)

Register DS1LOF counts occurrences of frame loss on the incoming side of the associated digital carrier.

The system obtains counts of frame loss when an audit runs at midnight. The system schedules audits to run at 10 min intervals, at a lower priority than operational measurement transfers. The audit reports frame losses during any given period. The number of frame losses that the audit reports can be high or low by 10 min increments.

The CARRIER display at a MAP terminal shows the number of frame losses accumulated from midnight. If the system returned to service after midnight, the CARRIER display shows the number of frame losses accumulated from the return to service. The system updates the carrier display every 6.5 s.

Register DS1LOF release history

Register DS1LOF was introduced before BCS20.

Associated registers

There are no associated registers.

Associated logs

The system generates PM110 when the DS-1 carrier exceeds maintenance or OOS thresholds.

Register DS1MBU

Manual busy usage (DS1MBU)

OM group DS1CARR (continued)

Register DS1MBU is a usage register. The scan rate is 100 s. Register DS1MBU records if a DS-1 carrier is manual busy.

Register DS1MBU release history

Register DS1MBU was introduced before BCS20.

BCS30

Software changed to provide use counts in CCS or deci-erlangs.

Associated registers

There are no associated registers.

Associated logs

The PM subsystem generates PM105 when a digital carrier module (DCM) is made manual busy.

The trunk maintenance subsystem generates TRK182 when problems occur during digitone reception for an incoming call over a trunk. The trunk maintenance subsystem also generates TRK182 when the system cannot determine the call destination.

Register DS1PBU

Peripheral side (P-side) busy usage (DS1PBU)

Register DS1PBU is a usage register. The scan rate is 100 s. Register DS1PBU records if a DS-1 carrier is P-side busy. A carrier is P-side busy when the carrier remote (P-side) PM is OOS.

Register DS1PBU release history

Register DS1PBU was introduced before BCS20.

BCS31

Register DS1PBU is always zero for PM type FRIU.

BCS30

Software changed to provide use counts in CCS or deci-erlangs.

Associated registers

There are no associated registers.

Associated logs

The PM subsystem generates PM183 when a P-side link becomes system busy.

OM group DS1CARR (continued)

Register DS1RCGA

Remote carrier group alarm (DS1RCGA)

Register DS1RCGA counts remote carrier group alarm messages that the system receives from the PM.

The system reports a remote DS-1 carrier group alarm when DIGIT TWO is zero for all incoming words for 450 ms. The alarm clears when the system removes the far-end DIGIT TWO forcing signal for 75 ms. When the alarm is active, the CC keeps the carrier system system busy.

Register DS1RCGA release history

Register DS1RCGA was introduced before BCS20.

Associated registers

There are no associated registers.

Associated logs

The PM subsystem generates PM109 when a T1 carrier line becomes system busy.

The trunk maintenance subsystem generates TRK109 when a test on a DS-1 fails.

Register DS1SBU

System busy usage (DS1SBU)

Register DS1SBU is a usage register. The scan rate is 100 s. Register DS1SBU records if a DS-1 carrier is system busy when:

- a removal from service occurs at the CARRIER level at a MAP. The DS-1 carrier exceeds the bipolar violation, accumulated frame loss, accumulated slip count, or OOS threshold.
- the carrier group alarm is active
- you remove a trunk card before you manually busy the carrier system
- the supporting digital PM is busy
- the system loses a carrier serving an RLM high data link controller that handles signaling traffic to and from the RLM

A carrier system becomes busy when the carrier reaches an OOS threshold. A carrier system remains OOS until you manually return the carrier to service.

OM group DS1CARR (continued)

Register DS1SBU release history

Register DS1SBU was introduced before BCS20.

BCS30

Software changed to provide use counts in CCS or deci-erlangs.

Associated registers

There are no associated registers.

Associated logs

The PM subsystem generates PM109 when a T1 carrier becomes system busy.

The trunk maintenance subsystem generated TRK109 when a test on a DS-1 fails.

Register DS1SES

DS-1 severe error seconds (DS1SES)

Register DS1SES counts DS-1 severe error seconds during XPM audits. Table CARRMTC identifies severe error second thresholds.

Register DS1SES release history

Register DS1SES was introduced in BCS24.

BCS28

Software changed to include counts for remote cluster controller central side (C-side) carriers.

Associated registers

There are no associated registers.

Associated logs

There are no associated logs.

Register DS1SLP

Frame slip (DS1SLP)

Register DS1SLP counts occurrences of frame slip on an associated digital carrier. Frame slip occurs as a result of overrun or underrun of the incoming bit stream.

The system obtains counts of frame loss when an audit runs at midnight. The system schedules audits to run at 10-minute intervals, at a lower priority than

OM group DS1CARR (end)

operational measurement transfers. The audit reports frame losses during any given period. The number of frame losses that the audit reports can be high or low by 10 min increments.

The CARRIER display at a MAP terminal shows the number of frame losses accumulated from midnight. If the system returned to service after midnight, the CARRIER display shows the number of frame losses accumulated from the return to service. The system updates the carrier display every 6.5 s.

Register DS1SLP release history

Register DS1SLP was introduced in BCS20.

BCS31

Register DS1SLP is always zero for PM type FRIU.

Associated registers

There are no associated registers.

Associated logs

The system generates PM112 one time every 24 hours for each DCM. The system generates PM112 when the CC resets the T1 carrier slip counter to 0.

Register DS1UAS

DS-1 unavailable seconds (DS1UAS)

Register DS1UAS counts DS-1 unavailable seconds during XPM audits.

The unavailable seconds is the duration that the DS-1 is not available for use.

DS1UAS release history

Register DS1UAS was introduced in BCS24.

BCS28

Software changed to include counts for remote cluster controller central side (C-side) carriers.

Associated registers

There are no associated registers.

Associated logs

There are no associated logs.

OM group DSPRMAN

OM description

Expanded OM name: Digital Signal Processor (DSP) Resource Module (RM) Resource Management (RMAN)

This group of OMs contains measures for continuity test (COT), dual tone multifrequency (DTMF), and tone synthesizer (TONESYN) resource events and usage statistics on the DMS-Spectrum Peripheral Module (SPM) in the trunking application. These resources exist only on DSP RMs on a SPM node.

There is one report per SPM node in a DMS switch. Although resource pools are provisioned and configured for each RM, OM reports are given for the node-level pools and not the RM-level pools.

This group of measures is used primarily to check capacity: most of the measures relate to the usage of resources on a SPM node. The report can also be used to measure trouble due to the number of lost resources.

Resources can be lost if an attempt is made to spare a failed RM, but there is no spare RM. Non-restorable resources (COT, DTMF, TONESYN) are always lost when an uncontrolled sparing action occurs. For controlled sparing actions, in-use non-restorable resources are released (that is, they are gracefully relinquished by call processing).

A "non-restorable" if spared, cannot be restored to call processing; therefore, it is lost to call processing. However, it is added to the resource pools when the RM it resides on comes in service (such as, DTMF, COT, and TONESYN). A "restorable resource," if spared, can be restored to call processing with the same state it was in prior to the sparing action (such as, ECAN and DTMF when they are used in FTR mode).

"Controlled sparing" (also called "unforced sparing") is a type of sparing action that occurs if a command is entered at the MAP terminal to deload an RM. The non-restorable resources on the RM are deloaded before the RMs are spared. "Uncontrolled sparing" is a sparing action that occurs as the result of a hardware fault that is detected by RM device maintenance or if a sparing action has been forced at the MAP terminal. The non-restorable resources on the RM are not deloaded before the RM hardware is spared.

"Deloading resources" refers to waiting for resources to be released by call processing before taking a sparing action. Deloading an RM refers to the process of allowing resources in use to be released under normal call processing circumstances. Deloading does not take place in an uncontrolled sparing scenario.

OM group DSPRMAN (continued)

DSPRMAN contains 21 peg registers that count the following events for COT, DTMF, TONESYN, and MF:

- available resource low-water-mark threshold violations
- resources lost
- resources denied
- resources utilized
- the highest number of resources allocated

OM group DSPRMAN is reported to the computing module (CM) from SPM using the SPM OM Transport System (SOTS). SOTS uses the distributed data manager (DDM) of the DMS switch to transport the data.

The interval for collection periods can be changed through office parameters. For example, if table OFCOPT parameter OMHISTORY is set to Y, parameter OMXFER in table OFCENG is disabled and the collection/transfer period for OMs is 5 minutes. When the collection period is 30 minutes, data is collected every 15 minutes. The data from each 15-minute transfer is combined to make a composite set of measurements for the one 30-minute collection.

When collecting OMs from peripherals, the OM base software on the CM gets the data for the active registers one minute before the end of the collection period. While still under control of the OM base software, all active registers become holding registers at the end of the collection period and the active registers are cleared.

For this reason, when using the CI command OMSHOW to see OM data, the active registers usually display as all zeroes, except for the last minute of the collection period. Look at the data in the holding registers. View the real-time data for the active registers directly on the SPM. Use the CM tool REMLOGIN to remotely login to the SPM. Then, at the SPM, change to the directory OMUTILS and use the CI command PRINT to see the active data.

Release history

OM group DSPRMAN was introduced in SPM01 (CSP09).

Registers

OM group DSPRMAN registers display on the MAP terminal as follows:

OM group DSPRMAN (continued)

COTLOW	COTLOST	COTDENY	COTUTIL
COTHI	COTFAIL	DTMFLOW	DTMFLOST
DTMFDENY	DTMFUTIL	DTMFHI	MFLOW
MFLOST	MFDENY	MFUTIL	MFHI
TONELow	TONELOST	TONEDENY	TONEUTIL
TOHEHI			

Group structure

OM group DSPRMAN

Key field:

nil_type_id

Info field:

sots_NODE_INFO

Associated OM groups

ECANRMAN

OM groups ECANRMAN and DSPRMAN contain operational measurements for resources managed by SPM resource management. OM counts are accumulated and reported for each of the different resource types.

Note: There is no mathematical relationship between OM groups ECANRMAN and DSPRMAN.

Associated functional groups

Not applicable

Associated functionality codes

Not applicable

OM logic flow or pseudocode

When SPM resource management requests a resource be attached to a trunk/call, the following high-level steps are followed. These steps result in OMs.

OM group DSPRMAN (continued)

- If a resource is available in the pool, resource management increments an internal usage count pertaining to the resource type. If the total allocated is greater than the current value of the high-water-mark, the high-water-mark register is set to the higher value.
- If a resource is not available for use in the pool, resource management increments the DENY register pertaining to the resource type.
- If a resource has been allocated/given to a user (call processing), and if the number of free resources in the pool is at or below the low-water-mark threshold on the pool, resource management increments the LOW register count pertaining to the resource type requested. An alarm may also generate.
- If resource management must take a resource away from a user (call processing) due to an RM sparing action, resource management increments the LOST register pertaining to the resource type. All non-restorable resources are always lost in uncontrolled sparing actions.
- DTMF, COT, and TONESYN are non-restorable resources.
- DTMF in reorigination mode is a restorable resource.
- If call processing does not relinquish a non-restorable resource, in order to complete the sparing action, resource management takes the non-restorable resource away from call processing. This results in resource management incrementing the LOST register for each resource type for each lost non-restorable resource.

On the local SPM's active common equipment module (CEM), at the end of a 100-second scan period, resource management calculates the percentage utilization of the resources in each of the resource pools and again computes the average for all previous scan periods since the beginning of the current collection period. This value is written to the OM register for percentage utilization of the resource type.

At the end of a transfer/collection period, all registers are zeroed.

The following illustrates a request for DSP resources.

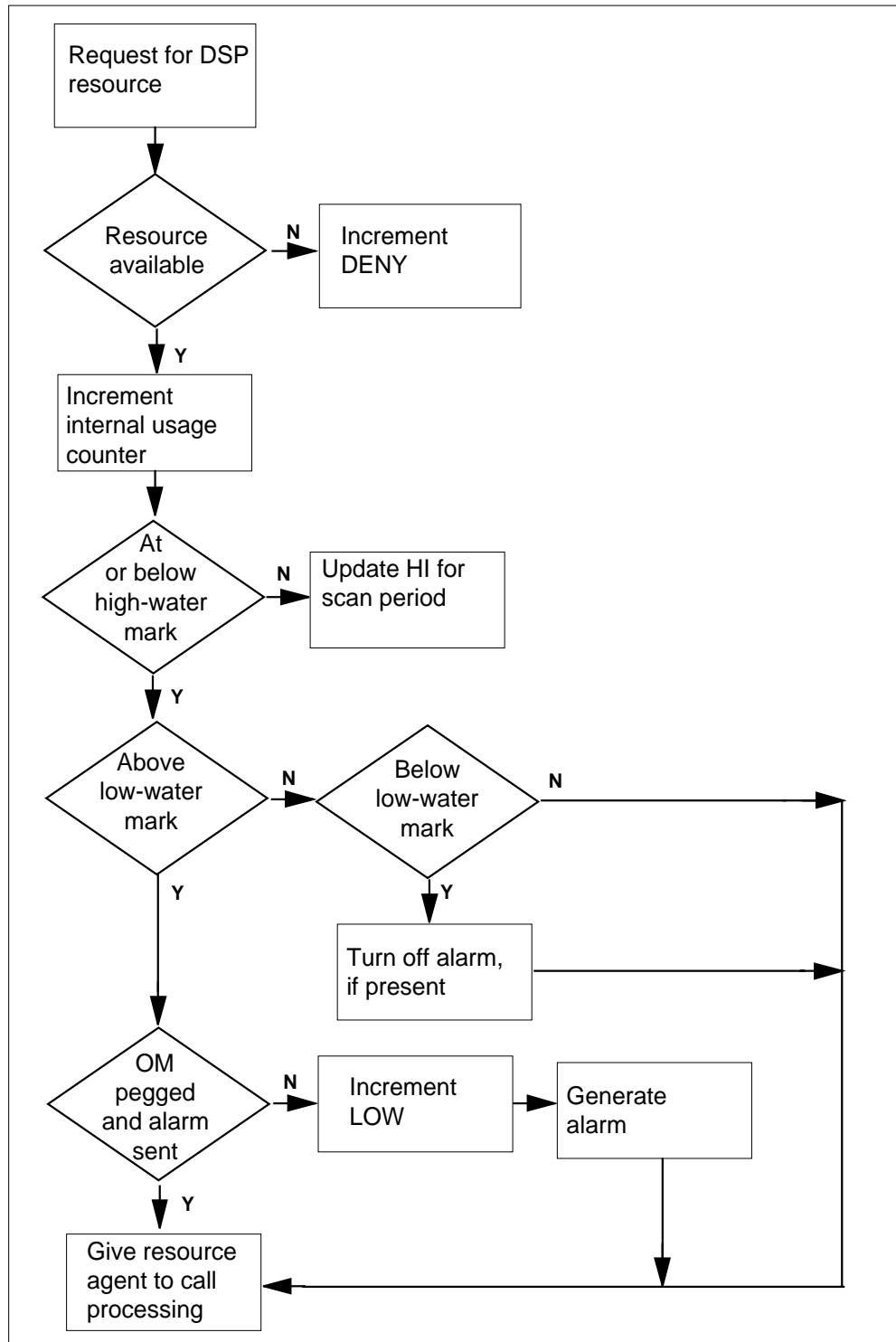
OM group DSPRMAN (continued)

OM group DSPRMAN (continued)

The following illustrates a loss of a DSP resource due to an RM sparing action.

Note 1: COTs are non-restorable resources, so they are lost in the event of sparing an RM. However, the CCS7 protocol allows retest of COT, so the lost resources get replaced/restored.

Note 2: The only restorable resource in DSP is the DTMF resource in reorigination mode.

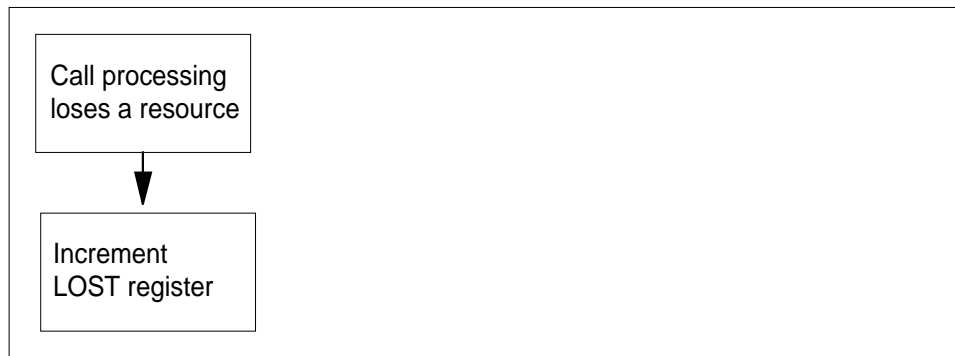

Register COTLOW

Expanded register name: COT low-water-mark threshold violations on the node-level COT pool

This register counts the low-water-mark threshold violations on the SPM node-level pool of COT resources since the last collection period. Crossing the threshold once indicates a potential for resource exhaustion on the node. Crossing the threshold more than once in a collection period indicates the user (call processing) is operating around the threshold for extended periods.

Operating around the threshold for extended periods indicates insufficient COT resources on the node. The corrective action is to provision another RM or another SPM to support the call rate and call mix.

Register COTLOW release history

Register COTLOW was introduced in SPM01 (CSP09).

Associated registers

COTUTIL

OM group DSPRMAN (continued)

The percentage of COTs at the node level is considered high whenever the low-water-mark threshold is crossed. Compute it using the threshold value and the queue size obtained from the SPM node-level MAP terminal.

Associated logs

SPM350 is an alarmed log and has a default status of minor.

Extension registers

Not applicable

Register COTLOST

Expanded register name: Number of COT resources lost by or taken away from resource management users

This register counts the COT resources taken away from or lost by resource management users (such as call processing).

Register COTLOST release history

Register COTLOST was introduced in SPM01 (CSP09).

Associated registers

Not applicable

Associated logs

Not applicable

Extension registers

Not applicable

Register COTDENY

Expanded register name: COT requests denied

Register COTDENY release history

Register COTDENY was introduced in SPM01 (CSP09).

Associated registers

COTUTIL should be 100% before COTDENY increments the peg register.

Associated logs

Not applicable

Extension registers

Not applicable

OM group DSPRMAN (continued)

Register COTUTIL

Expanded register name: Percent utilization of COT resources

COTUTIL calculates the percentage of the total COT resources in the node-level pool allocated to users of resource management (such as call processing). COTUTIL is the average percentage utilization for all scan periods during a collection/transfer period. COTUTIL does not indicate the total number in use at the end of a scan or transfer period.

Note: It is output as a peg register at the CM, but it represents COT resource usage. As far as the OM subsystem is concerned, it is only a pegged count. The percentage statistic is computed locally on the SPM by the resource management at 100-second scan intervals. A local peg is updated, and at the end of the collection period, the average of averages for all scan intervals is output at the CM as a peg register.

Register COTUTIL release history

Register COTUTIL was introduced in SPM01 (CSP09).

Associated registers

Not applicable

Associated logs

Not applicable

Extension registers

Not applicable

Register COTHI

Expanded register name: High-water-mark for COT allocations from the COT pool

COTHI counts the highest number of COT resources allocated from the node-level pool during a collection/transfer period. Its value starts at zero at the beginning of each collection/transfer period for the node. An update occurs when there is a new high-water-mark in the collection period. This occurs when the total number of resources allocated from the COT pool exceeds the previous high-water-mark for the pool.

Register COTHI release history

Register COTHI was introduced in SPM01 (CSP09).

OM group DSPRMAN (continued)

Associated registers

Not applicable

Associated logs

Not applicable

Extension registers

Not applicable

Register COTFAIL

Expanded register name: COT failed for the CCS7 trunk

This register counts the CCS7 COT failures seen for trunks on each SPM node. These events are reported by the DSP application running on the RM. They are pegged on the active CEM of each SPM.

Register COTFAIL release history

Register COTFAIL was introduced in SPM01 (CSP09).

Associated registers

Not applicable

Associated logs

Not applicable

Extension registers

Not applicable

Register DTMFLOW

Expanded register name: DTMF low-water-mark threshold violations on the node-level DTMF pool

This register counts the low-water-mark threshold violations on the SPM node-level pool of DTMF resources since the last collection period. Crossing the threshold once indicates a potential for resource exhaustion on the node. Crossing the threshold more than once in a collection period indicates the user (call processing) is operating around the threshold for extended periods.

Operating around the threshold for extended periods indicates insufficient DTMF resources on the node. The corrective action is to provision another RM or another SPM to support the call rate and call mix.

OM group DSPRMAN (continued)

Register DTMFLOW release history

Register DTMFLOW was introduced in SPM01 (CSP09).

Associated registers

DTMFUTIL

The percentage of DTMFs at the node level is considered high whenever the low-water-mark threshold is crossed. Compute it using the threshold value and the queue size obtained from the SPM node-level MAP terminal.

Associated logs

SPM350 is an alarmed log and has a default status of minor.

Extension registers

Not applicable

Register DTMFLOST

Expanded register name: DTMF resources lost by or taken away from resource management users

This register counts the DTMF resources taken away from users of SPM resource management (such as call processing) due to sparing actions.

Register DTMFLOST release history

Register DTMFLOST was introduced in SPM01 (CSP09).

Associated registers

Not applicable

Associated logs

Not applicable

Extension registers

Not applicable

Register DTMFDENY

Expanded register name: DTMF resources denied

Register DTMFDENY release history

Register DTMFDENY was introduced in SPM01 (CSP09).

OM group DSPRMAN (continued)

Associated registers

DTMFUTIL should be 100% before DTMFDENY increments the peg register.

Associated logs

Not applicable

Extension registers

Not applicable

Register DTMFUTIL

Expanded register name: Percent utilization of DTMF resources

DTMFUTIL calculates the percentage of the total DTMF resources in the node-level pool allocated to users of resource management (such as call processing). DTMFUTIL is the average percentage utilization for all scan periods during a collection/transfer period. It does not indicate the total number in use at the end of a scan or transfer period.

Note: It is output as a peg register at the CM, but it represents DTMF resource usage. As far as the OM subsystem is concerned, it is only a pegged count. The percentage statistic is computed locally on the SPM by the resource management at 100-second scan intervals. A local peg is updated and at the end of the collection period the average of averages for all scan intervals is output at the CM as a peg register.

Register DTMFUTIL release history

Register DTMFUTIL was introduced in SPM01 (CSP09).

Associated registers

Not applicable

Associated logs

Not applicable

Extension registers

Not applicable

Register DTMFHI

Expanded register name: High-water-mark for DTMF allocations from the DTMF pool

OM group DSPRMAN (continued)

DTMFHI counts the highest number of DTMF resources allocated from the node-level pool during a collection/transfer period. Its value starts at zero at the beginning of each collection/transfer period for the node. An update occurs when there is a new high-water-mark in the collection period. This occurs when the total number of resources allocated from the DTMF pool exceeds the previous high-water-mark for the pool.

Register DTMFHI release history

Register DTMFHI was introduced in SPM01 (CSP09).

Associated registers

Not applicable

Associated logs

Not applicable

Extension registers

Not applicable

Register TONELOW

Expanded register name: TONESYSN low-water-mark threshold violations on the node-level TONESYSN pool

This register counts the low-water-mark threshold violations on the SPM node-level pool of TONE resources since the last collection period. Crossing the threshold once indicates a potential for resource exhaustion on the node. Crossing the threshold more than once in a collection period indicates the user (call processing) is operating around the threshold for extended periods.

Operating around the threshold for extended periods indicates insufficient TONE resources on the node. The corrective action is to provision another RM or another SPM to support the call rate and call mix.

Register TONELOW release history

Register TONELOW was introduced in SPM01 (CSP09).

Associated registers

TONEUTIL

The percentage of TONEs at the node level is considered high whenever the low-water-mark threshold is crossed. Compute it using the threshold value and the queue size obtained from the SPM node-level MAP terminal.

OM group DSPRMAN (continued)

Associated logs

SPM350 is an alarmed log and has a default status of minor.

Extension registers

Not applicable

Register TONELOST

Expanded register name: Number of TONESYSN resources taken away from or lost by resource management users

This register counts the TONE resources taken away from users of SPM resource management (such as call processing) due to sparing actions.

Register TONELOST release history

Register TONELOST was introduced in SPM01 (CSP09).

Associated registers

Not applicable

Associated logs

Not applicable

Extension registers

Not applicable

Register TONEDENY

Expanded register name: TONESYSN resources denied

Register TONEDENY release history

Register TONEDENY was introduced in SPM01 (CSP09).

Associated registers

TONEUTIL should be 100% before TONEDENY increments the peg register.

Associated logs

Not applicable

Extension registers

Not applicable

Register TONEUTIL

Expanded register name: Percent utilization of TONESYSN resources

OM group DSPRMAN (continued)

TONEUTIL calculates the percentage of the total TONE resources in the node-level pool allocated to users of resource management (such as call processing). TONEUTIL is the average percentage utilization for all scan periods during a collection/transfer period. It does not indicate the total number in use at the end of a scan or transfer period.

Note: It is output as a peg register at the CM but it represents TONE resource usage. As far as the OM subsystem is concerned, it is only a pegged count. The percentage statistic is computed locally on the SPM by the resource management at 100-second scan intervals. A local peg is updated and at the end of the collection period the average of averages for all scan intervals is output at the CM as a peg register.

Register TONEUTIL release history

Register TONEUTIL was introduced in SPM01 (CSP09).

Associated registers

Not applicable

Associated logs

Not applicable

Extension registers

Not applicable

Register TONEHI

Expanded register name: High-water-mark for TONESYSN resource allocations from the TONESYSN pool

TONEHI counts the highest number of TONE resources allocated from the node-level pool during a collection/transfer period. Its value starts at zero at the beginning of each collection/transfer period for the node. An update occurs when there is a new high-water-mark in the collection period. This occurs when the total number of resources allocated from the TONE pool exceeds the previous high-water-mark for the pool during the collection period.

Register TONEHI release history

Register TONEHI was introduced in SPM01 (CSP09).

Associated registers

Not applicable

Associated logs

Not applicable

OM group DSPRMAN (continued)

Extension registers

Not applicable

Register MFLOW

Expanded register name: Multifrequency (MF) low-water-mark threshold violations on the node-level MF pool

This register counts the low-water-mark threshold violations on the SPM node-level pool of MF resources since the last collection period. Crossing the threshold once indicates a potential for resource exhaustion on the node. Crossing the threshold more than once in a collection period indicates the user (call processing) is operating around the threshold for extended periods.

Operating around the threshold for extended periods indicates insufficient MF resources on the node. The corrective action is to provision another RM or another SPM to support the call rate and call mix.

Register MFLOW release history

Register MFLOW was introduced in SPM01 (CSP09).

Associated registers

MFUTIL

The percentage of MFs at the node level is considered high whenever the low-water-mark threshold is crossed. Compute it using the threshold value and the queue size obtained from the SPM node-level MAP terminal.

Associated logs

SPM350 is an alarmed log and has a default status of minor.

Extension registers

Not applicable

Register MFLOST

Expanded register name: Number of MF resources lost by or taken away from resource management users

This register counts the MF resources taken away from users of SPM resource management (such as call processing) due to sparing actions.

Register MFLOST release history

Register MFLOST was introduced in SPM01 (CSP09).

OM group DSPRMAN (continued)

Associated registers

Not applicable

Associated logs

Not applicable

Extension registers

Not applicable

Register MFDENY

Expanded register name: MF resources denied (call processing failed to allocate for a call)

Register MFDENY release history

Register MFDENY was introduced in SPM01 (CSP09).

Associated registers

MFUTIL should be 100% before MFDENY increments the peg register.

Associated logs

Not applicable

Extension registers

Not applicable

Register MFUTIL

Expanded register name: Average percent utilization of MF resources

MFUTIL calculates the percentage of the total MF resources in the node-level pool allocated to users of resource management (such as call processing). MFUTIL is the average percentage utilization for all scan periods during a collection/transfer period. It does not indicate the total number in use at the end of a scan or transfer period.

Note: It is output as a peg register at the CM, but it represents MF resource usage. As far as the OM subsystem is concerned, it is only a pegged count. The percentage statistic is computed locally on the SPM by the resource management at 100-second scan intervals. A local peg is updated, and at the end of the collection period, the average of averages for all scan intervals is output at the CM as a peg register.

Register MFUTIL release history

Register MFUTIL was introduced in SPM01 (CSP09).

OM group DSPRMAN (end)

Associated registers

Not applicable

Associated logs

Not applicable

Extension registers

Not applicable

Register MFHI

Expanded register name: High-water-mark for MF allocations from the MF pool

MFHI counts the highest number of MF resources allocated from the node-level pool during a collection/transfer period. Its value starts at zero at the beginning of each collection/transfer period for the node. An update occurs when there is a new high-water-mark in the collection period. This occurs when the total number of resources allocated from the MF pool exceeds the previous high-water-mark for the pool.

Register MFHI release history

Register MFHI was introduced in SPM01 (CSP09).

Associated registers

Not applicable

Associated logs

Not applicable

Extension registers

Not applicable

OM group DUTLGEN

OM description

DMS universal transport layer (DUTLGEN)

The OM group DUTLGEN measures activity within the DMS universal transport layer in an office, including:

- system events
- connect events
- refuse events
- disconnect events
- protocol errors
- system errors

Release history

The OM group DUTLGEN was introduced in BCS27.

Registers

The OM group DUTLGEN registers appears on the MAP terminal as follows:

DUTLSYEV	DUTLCOEV	DUTLREEV	DUTLDIEV
DUTLPRER	DUTLSYER		

Group structure

The OM group DUTLGEN provides one tuple per office.

Key field:

There is no Key field.

Info field:

There is no Info field.

Associated OM groups

The OM group DAISGEN - similar information for data access/information services

Associated functional groups

The functional group Enhanced Input Output Controller associates with the OM group DUTLGEN.

OM group DUTLGEN (continued)

Associated functionality codes

The associated functionality codes for the OM group DUTLGEN appear in the following table.

Functionality	Code
CNS-Data Access Interface	NTXG13AA

OM group DUTLGEN (continued)

OM group DUTLGEN registers

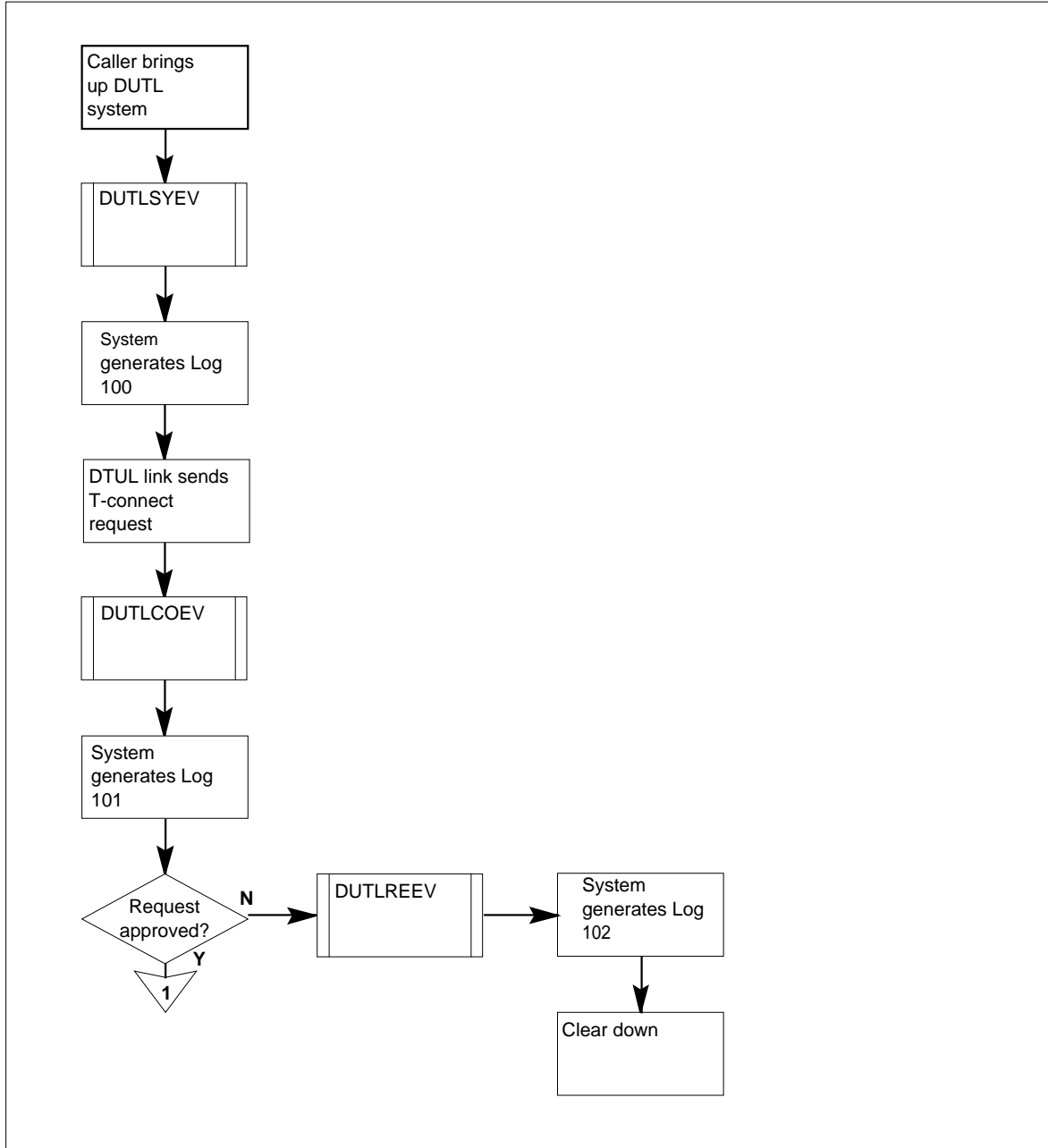

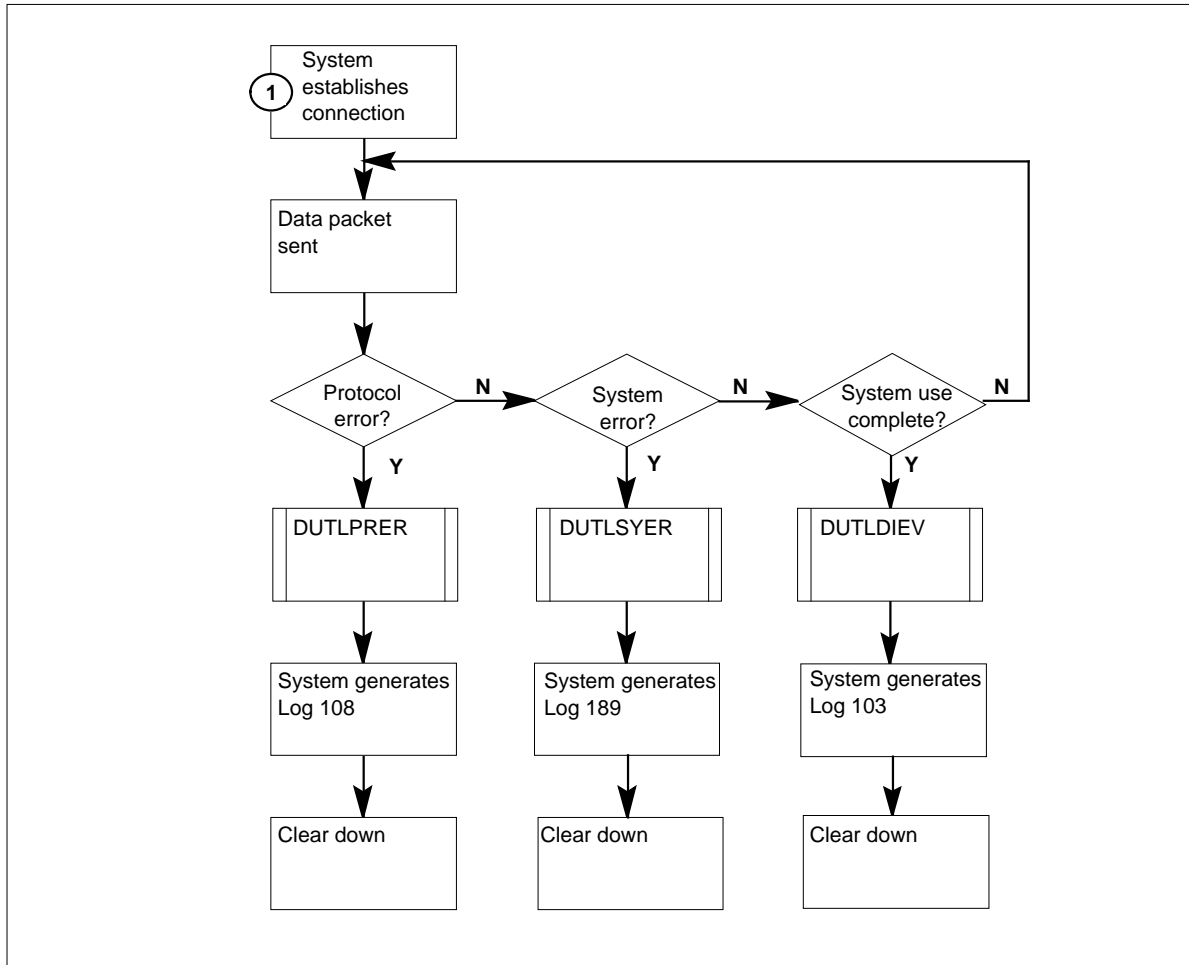
OM group DUTLGEN (continued)**OM group DUTLGEN registers (continued)****Register DUTLCOEV**

DMS universal transport layer connect events (DUTLCOEV)

Register DUTLCOEV counts the number of connect events that occur in the DMS universal transport layer. An example of a connect event is a T-connect request.

Register DUTLCOEV release history

Register DUTLCOEV was introduced in BCS27.

Associated registers

There are no associated registers.

OM group DUTLGEN (continued)

Associated logs

The system generates the DUTL101 when a connect event occurs. The log report includes date, time, and explanatory text.

Register DUTLDIEV

DMS universal transport layer disconnect events (DUTLDIEV)

Register DUTLDIEV counts the number of disconnect events that occur in the DMS universal transport layer. An example of a disconnect event is the close of a network connection.

Register DUTLDIEV release history

Register DUTLDIEV was introduced in BCS27.

Associated registers

There are no associated registers.

Associated logs

The system generates the DUTL103 when a disconnect event occurs. The log report includes date, time, and explanatory text.

Register DUTLPRER

DMS universal transport layer protocol errors (DUTLPRER)

Register DUTLPRER counts the number of protocol errors that occur in the DMS universal transport layer.

Register DUTLPRER release history

Register DUTLPRER was introduced in BCS27.

Associated registers

There are no associated registers.

Associated logs

The system generates the DUTL198 when a protocol error occurs. The log report includes date, time, and explanatory text.

Register DUTLREEV

DMS universal transport layer refuse events (DUTLREEV)

Register DUTLREEV counts the number of refuse events that occur in the DMS universal transport layer. A refuse event occurs when a session request for connection receives a disconnect message.

OM group DUTLGEN (end)

Register DUTLREEV release history

Register DUTLREEV was introduced in BCS27.

Associated registers

There are no associated registers.

Associated logs

The system generates the DUTL102 when a refuse event occurs. The log report includes date, time, and explanatory text.

Register DUTLSYER

DMS universal transport layer system errors (DUTLSYER)

Register DUTLSYER counts the number of system errors that occur in the DMS universal transport layer.

Register DUTLSYER release history

Register DUTLSYER was introduced in BCS27

Associated registers

There are no associated registers.

Associated logs

The system generates the DUTL199 when a system error occurs. The log report includes date, time, and explanatory text.

Register DUTLSYEV

DMS universal transport layer system events (DUTLSYEV)

Register DUTLSYEV counts the number of system events that occur in the DMS universal transport layer. An example of a system event is bringing the network up.

Register DUTLSYEV release history

Register DUTLSYEV was introduced in BCS27.

Associated registers

There are no associated registers.

Associated logs

The system generates the DUTL100 when a system event occurs. The log report includes date, time, and explanatory text.

OM group EACARR

OM description

Equal access carrier measurements (EACARR)

The EACARR provides information on equal access measurements for each carrier that connects to the access tandem (AT). The EACARR makes measurements for each InterLATA carrier (IC) or international carrier (INC).

Release history

OM group EACARR was introduced before BCS20.

BCS24

Registers EADOMES and EAINTL were modified to include Feature Group C (FGC) carriers in BCS24. Registers EADOMPIC, EADOMXXX, EAINTPIC, and EAINTPIC were introduced in BCS24.

Registers

OM group EACARR registers appear on the MAP terminal as follows:

EAWNKFL	EADOMES	EAINTL	EAINTRM
EAACKFL	EADOMPIC	EADOMXXX	EAINTPIC
EAINTPIC			

Group structure

OM group EACARR provides one tuple for each carrier.

Key field:

IC_INC_CARRIER_NAME

Info field:

There is no info field

The CARRNAME in table OCCINFO defines the carrier names.

Associated OM groups

OM group EATSMS associates with OM group EACARR.

The TRK group OM contains operational measurements on the trunks between the end office and the AT.

Associated functional groups

The Access Tandem functional group associates with OM group EACARR.

OM group EACARR (continued)

Associated functionality codes

The functionality codes associated with OM group EACARR appear in the following table.

Functionality	Code
Equal Access End Office	NTX186AA
Access Tandem Switch	NTX386AA

OM group EACARR (continued)

OM group EACARR registers

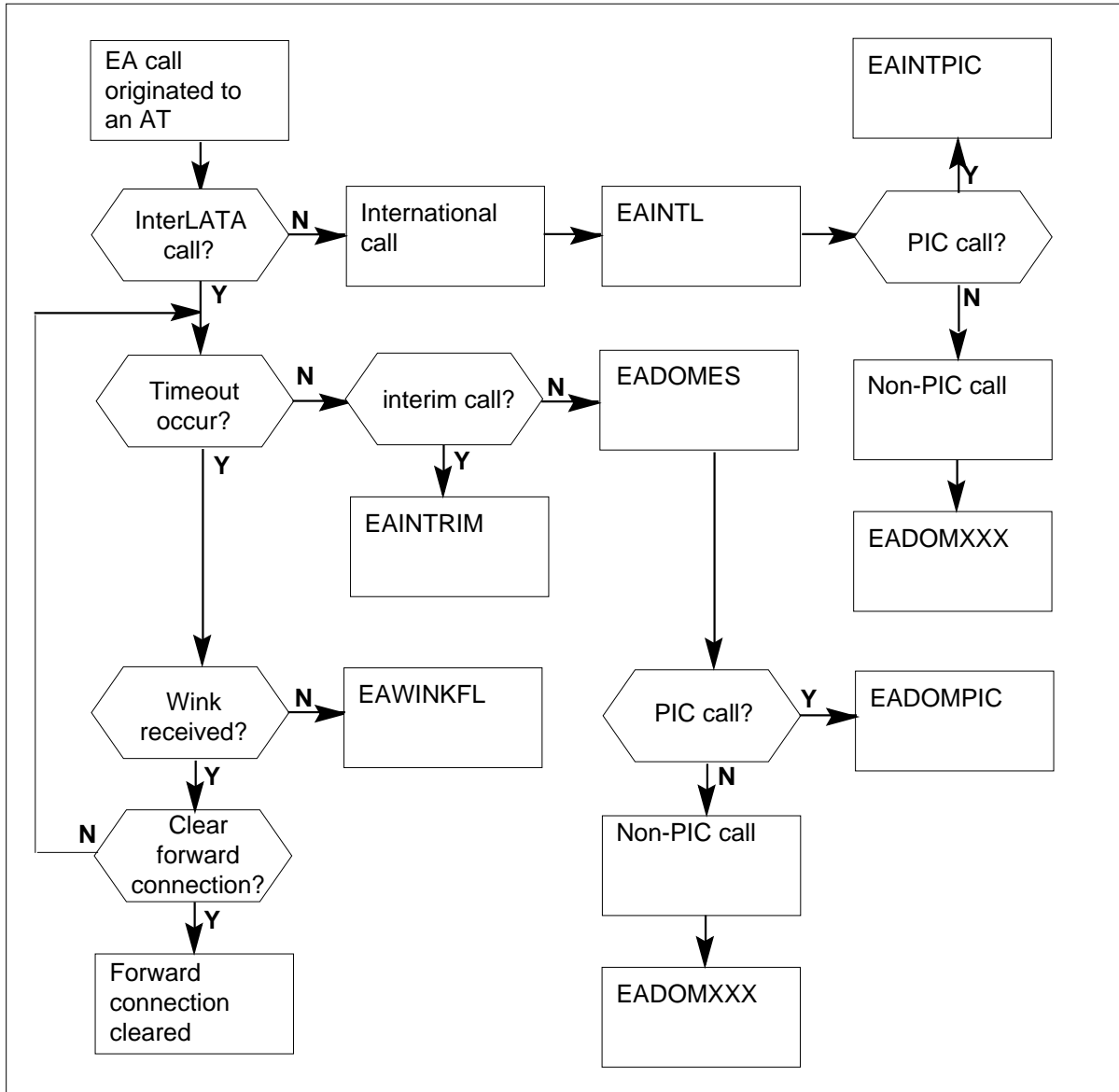

Register EAACKFL-U.S. only

Equal access acknowledgement failures (EAACKFL)

Register EAACKFL counts timeouts that occur before an acknowledgement wink from the carrier. Register EAACKFL increases only when the end office clears the forward connection. When the end office does not respond to the absence of the acknowledgement, the end office clears the forward connection.

OM group EACARR (continued)

The following office parameters in table OFCSTD define timeout periods.

- EA_REC_MAX_WK_TIME
- EA_REC_SUB_PRE_WK_TIME
- EA_REC_1ST_PRE_WK_TIME

Register EAACKFL release history

Register EAACKFL was introduced before BCS20.

BCS27

Software changed to contain call failures or call abandons in ISUP access tandem FGD signaling.

Associated registers

One of EADOMES, EAINTL or EAINTRM increases when EAACKFL increases.

Register EAACKFL does not count calls that increase in EAWNKFL.

Associated logs

There are no associated logs.

Extension registers

There are no extension registers.

Register EADOMES-U.S. only

Equal access domestic calls (EADOMES)

Register EADOMES counts incoming domestic equal access and LATA equal access system (LEAS) IC/INC calls. These carriers are both Primary InterLATA (PIC) and non-PIC carriers. The EADOMES counts incoming calls to the access tandem for a specified carrier. When the system attempts to complete a call, the register increases even if the call does not complete. This register also counts domestic calls that originate from the equal access end office (EAEO) to that carrier.

Register EADOMES release history

Register EADOMES was introduced before BCS20.

BCS24

Modified to include Feature Group C (FGC) carriers in BCS24.

OM group EACARR (continued)

Associated registers

There are no associated registers.

Associated logs

There are no associated logs.

Extension registers

There are no extension registers.

Register EADOMPIC

Equal access domestic PIC calls (EADOMPIC)

Register EADOMPIC counts originating equal access and LATA equal access system (LEAS) domestic PIC calls destined for a specified carrier.

Register EADOMPIC release history

Register EADOMPIC was introduced in BCS24.

Associated registers

There are no associated registers.

Associated logs

There are no associated logs.

Extension registers

There are no extension registers.

Register EADOMXXX

Equal access domestic non-PIC calls (EADOMXXX)

Register EADOMXXX counts originating equal access and LEAS domestic non-PIC calls destined for a specified carrier.

Register EADOMXXX release history

Register EADOMXXX was introduced in BCS24.

Associated registers

There are no associated registers.

Associated logs

There are no associated logs.

OM group EACARR (continued)

Extension registers

There are no extension registers.

Register EAINTL-U.S. only

Equal access international calls (EAINTL)

Register EAINTL counts incoming international equal access and LEAS, both PIC and non-PIC calls. The EAINTL counts the calls to the access tandem that are for a specified carrier. When the system attempts to complete a call, the register increases even if the call does not complete.

This register increases for all international calls from the equal access end office (EAEO) to a specified carrier.

Register EAINTL release history

Register EAINTL was introduced before BCS20.

BCS24

Modified to contain Feature Group C (FGC) carriers in BCS24.

Associated registers

There are no associated registers.

Associated logs

There are no associated logs.

Extension registers

There are no extension registers.

Register EAINTRM

Equal access incoming interim calls (EAINTRM)

Register EAINTRM counts incoming interim (950-YXXX) calls to the access tandem that are for a specified carrier. Register EAINTRM also counts 950-YXXX calls that originate from the EAEO to the same carrier. When the system attempts to complete a call, the register increases even if the call cannot complete.

Register EAINTRM release history

Register EAINTRM was introduced before BCS20.

Associated registers

There are no associated registers.

OM group EACARR (continued)

Associated logs

There are no associated logs.

Extension registers

There are no extension registers.

Register EAINTPIC

Equal access international PIC calls (EAINTPIC)

Register EAINTPIC counts originating equal access and LEAS international PIC calls destined for a specified carrier.

Register EAINTPIC release history

Register EAINTPIC was introduced in BCS24.

Associated registers

There are no associated registers.

Associated logs

There are no associated logs.

Extension registers

There are no extension registers.

Register EAINXXX

Equal access international non-PIC calls (EAINXXX)

Register EAINXXX counts originating equal access and LEAS international non-PIC calls destined for a specified carrier.

Register EAINXXX release history

Register EAINXXX was introduced in BCS24.

Associated registers

There are no associated registers.

Associated logs

There are no associated logs.

Extension registers

There are no extension registers

OM group EACARR (end)

Register EAWNKFL-U.S. only

Equal access wink failures (EAWNKFL)

Register EAWNKFL counts timeouts that occur before the first start pulsing wink from the InterLATA carrier (IC). Register EAWNKFL counts timeouts on domestic and international calls.

The following office parameters in table OFCSTD define timeout periods:

- EA_REC_MAX_WK_TIME
- EA_REC_SUB_PRE_WK_TIME
- EA_REC_1ST_PRE_WK_TIME

Register EAWNKFL release history

Register EAWNKFL was introduced before BCS20.

BCS27

Software changes to contain call failures or call abandons in ISUP access tandem FGD signaling.

Associated registers

One of registers EADOMES, EAINTL, or EAINTRM increases when EAWNKFL increases.

Register EAWNKFL does not count calls that cause EAACKFL to increase.

Associated logs

There are no associated logs.

Extension registers

There are no extension registers.

OM group EADLD

OM description

The Special Number Handling (EADLD) OM group provides information applicable to a specific market. This OM group does not apply to general UCS DMS-250 switch users. When registers for this group appear in the general UCS DMS-250 user's switch, their value is always 0.

When this OM group does apply, the information needs to be available to the offline processor or EADAS machine.

Release history

UCS14 introduced OM group EADLD (A60008434).

Registers

OM group EADLD registers display on the MAP terminal as follows:

```
CLASS: ACTIVE
START:2000/2/17 14:30:00 WED; STOP:2000/2/17 15:34:15 WED;
SLOWSAMPLES: 3; FASTSAMPLES: 25;

EA          EL
0           0
```

Group structure

OM group EADLD

Key field:

None

Info field:

None

Associated OM groups

None

Register EA

Register EA counts the total number of special number type 1 calls received by the UCS DMS-250 switch.

Register EA release history

UCS14 introduced register EA.

OM group EADLD (end)

Associated registers

None

Associated logs

None

Extension registers

None

Register validation

None

Register EL

Register EL. Register EL counts the total number of special number type 2 calls received by the UCS DMS-250 switch.

Register EL release history

UCS14 introduced register EL.

Associated registers

None

Associated logs

None

Extension registers

None

Register validation

None

OM group EATSMS

OM description

Equal access traffic separation/traffic analysis (EATSMS)

This group provides information about call attempts, call set-up time, and call connection time. The EATSMS provides information at carrier separation number and outgoing trunk separation number intersections. The EATSMS counts calls that the system cannot deliver to that intersection because an outgoing trunk is not available.

The EATSMS group separates traffic from one point to the next point. The EATSMS can separate three components of each call:

- point-to-point attempt increase
- set-up time
- point-to-point connect time

The EATSMS group separates carrier and trunk group traffic into the following call types:

- intraLATA-interstate
- interLATA-intrastate
- interLATA-interstate call types

The other common carrier separation number (OCCSEPNO) in table OCCINFO identifies a carrier for traffic separation. The range of values for OCCSEPNO is 0 to 127.

Field TRAFSNO indicates the outgoing trunk group in tables TRKGRP, ANNS, TONES, or STN.

Table OCCTSINT indicates four fields for each instance of carrier and trunk group. The fields are:

- LDSRA for intraLATA-intrastate calls
- LDIRA for intraLATA-interstate calls
- LDSER for interLATA-intrastate calls
- LDIER for interLATA-interstate calls

Note: The GSF software does not increase the OM group EATSMS.

Release history

The OM group EATSMS was introduced before BCS20.

OM group EATSMS (continued)**Registers**

The OM group EATSMS registers appear on the MAP terminal as follows:

OCCTSPEG	OCCTSPG2	OCCTSOVF	OCCTSSU
OCCTSSU2	OCCTSCU	OCCTSCU2	

Group structure

The OM group EATSMS registers provide one tuple for each key, OCCTS_REG_NOS.

Key field:

OCCTS_REG_NOS is an integer in the range 0 to 2047 as

assigned to the carrier and trunk group intersection in fields

LDSRA, LDIRA, LDSER, and LDIER in table OCCTSINT.

Info field:

Does not apply

The following office parameters apply:

- The NO_OCCTS_OM_REGISTERS in table OFCENG specifies the maximum number of OM registers allocated for EA traffic separation.
- The OCCT_DEFAULT_REG_LOG in table OFCVAR controls the production of the default register log report EATS100. The system generates this log when traffic is sent to the default register.
- The OCCTS_ENHANCED_FEATURE appears in table OFCENG. To activate the EA traffic separation option set this feature to Y (yes). The size of the maximum matrix is 128 by 128 and the OM register allocation is 2048.

Associated OM groups

The TFCANA group provides information on call attempts, call set-up time, and call connect time at source-traffic-separation and destination-traffic-separation intersections.

Associated functional groups

The operating group Access Tandem associates with the OM group EATSMS.

OM group EATSMS (continued)

Associated functionality codes

The functionality codes associated with OM group EATSMS appear in the following table.

Functionality	Code
Traffic Separation Increase Count	NTX085AA
Traffic Separation Use	NTX087AA

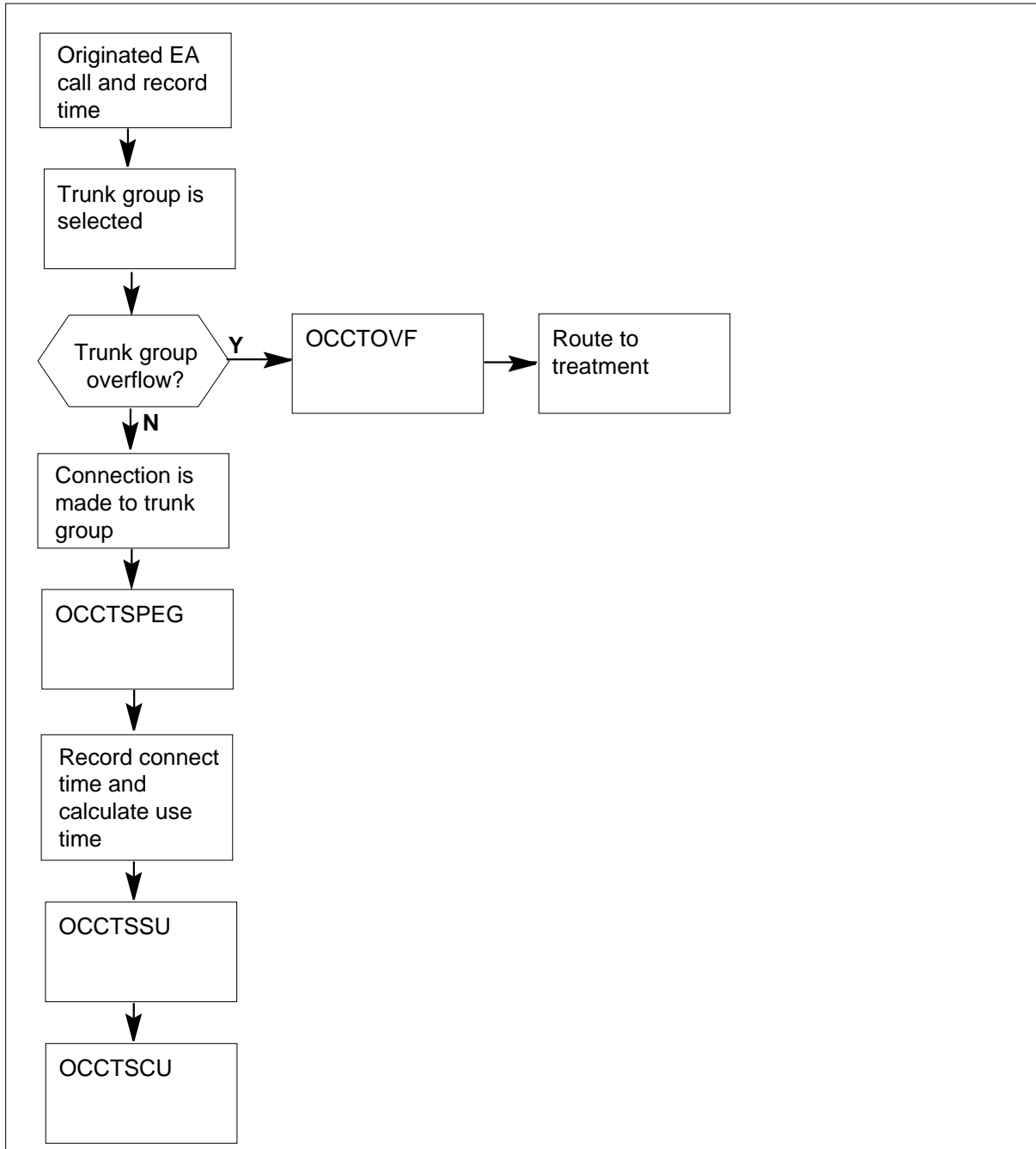
OM group EATSMS (continued)**OM group EATSMS registers****Register OCCTSCU**

OCC traffic separation connect usage

OM group EATSMS (continued)

This register is a use register. This register has a slow scan rate of 100 seconds. The OCCTSCU register records connections at carrier and trunk group intersections.

First the system collects set-up use at the intersection then the system can collect connect use. At the attempt point, the state of the call is set. On call connection the use scan begins to accumulate at the carrier and trunk group intersection.

There is no connect use for partial dial abandon calls. For overlap carrier selected calls, the system collects connect use for partial dial timeout calls. The system collects connect use at the carrier and treatment intersection when there is interdigit timeout.

Register OCCTSCU release history

OCCTSCU was introduced before BCS20.

Associated registers

Does not apply

Associated logs

Does not apply

Extension registers

OCCTSCU2

Register OCCTSOVF

OCC traffic separation overflow

The OCCTSOVF register counts overflow calls from a carrier and trunk group intersection.

Register OCCTSOVF release history

OCCTSOVF was introduced before BCS20.

Associated registers

Does not apply

Associated logs

Does not apply

Extension registers

Does not apply

OM group EATSMS (continued)

Register OCCTSPEG

OCC traffic separation peg count

The OCCTSPEG register counts network connections at each carrier and trunk group intersection.

The carrier and treatment intersection counts partial dial timeout. Use the generic separation number 1 for partial dial abandon calls. Partial dial abandon calls are only counted if the call contains associated overlap carrier call selection (OCS). Calls are also counted when the call has equal access, or the system seizes the trunk.

When the system cannot determine if the call is an equal access call, the system does not count the false state abandon

Register OCCTSPEG release history

OCCTSPEG was introduced prior to BCS20.

Associated registers

Does not have

Associated logs

Does not have

Extension registers

OCCTSPEG2

Register OCCTSSU

OCC traffic separation set-up usage

The OCCTSSU register is a record of the use set-up at each carrier and trunk group intersection. The set-up use is the number of seconds, between origination and connection of a call.

The Set-up count begins when the origination message arrives in the central control. For MF/DTMF trunks, this is the time of seizure. When the network connects to the first available destination terminal, the system calculates the time from origination to connection to a second. The system adds to the register at the carrier and trunk group intersection.

The system collects set-up use for partial dial timeout calls at the carrier and treatment intersection.

OM group EATSMS (end)

The system collects set-up use for false start abandon calls at the carrier by 7 intersection. The system collects set-up use for partial dial abandon calls at the carrier by 1 intersection.

For overlap carrier selected calls, the system collects set-up use at the carrier and trunk group intersection. The system collects this information as soon as enough digits are available to route the call. The system collects the information before all digits are collected. The set-up use is not collected at the carrier by 1 or carrier and treatment intersections even if the call is abandoned.

Register OCCTSSU release history

OCCTSSU was introduced prior to BCS20.

Associated registers

Does not apply

Associated logs

Does not apply

Extension registers

OCCTSSU2

OM group ECANRMAN

OM description

Expanded OM name: Echo Cancellor (ECAN) Resource Management (RMAN)

This group of OMs contains measures for echo canceller (ECAN) resource events and usage statistics on the DMS-Spectrum Peripheral Module (SPM).

There is one report per SPM node in the DMS system. Reports are not given for the resource module (RM) level even though the provisioning takes place at the RM level. Instead, OMs for the resource pools are given for the SPM node level.

This group of measures is used to check capacity: several of these measures relate to usage of the ECAN resources on a node-level basis. This group of OMs can also be used to measure trouble due to ECAN failure to converge Support Operating System (SOS) message events or potential trouble as indicated by the number of lost ECAN resources.

ECANRMAN contains six peg registers that count the following events:

- available resource low-water-mark threshold violations
- resources lost
- resources denied
- SOS events
- resources utilized
- the highest number of resources allocated
- total attempts overflow
- total attempts
- pool usage seconds

OM group ECANRMAN is reported to the computing module (CM) of the SPM using the SPM OM Transport System (SOTS). SOTS uses the distributed data manager (DDM) of the DMS switch to transport the data.

The interval for collection periods can be changed through office parameters. For example, if table OFCOPT parameter OMHISTORY is set to Y, parameter OMXFER in table OFCENG is disabled and the collection/transfer period for OMs is 5 minutes. When the collection period is 30 minutes, data is collected every 15 minutes, and the data from each 15-minute transfer is combined to make a composite set of measurements for the one 30-minute collection.

OM group ECANRMAN (continued)

When collecting OMs from peripherals, the OM base software in the CM gets the data for the active registers one minute before the end of the collection period. While still under control of the OM base software, all active registers become holding registers at the end of the collection period and the active registers are cleared.

For this reason, when using the CI command *OMSHOW* to see OM data, the active registers usually display as all zeroes, except for the last minute of the collection period. Look at the data in the holding registers. View the real-time data for the active registers directly on the SPM. Use the CM tool *remlogin* to remotely log in to SPM, then change to the directory *omutils* and use the CI command *print* to see the active data.

Release history

SP11

AF7913 added the following registers in SPM01 (CSP09):

- ATMPTSOV (Total Attempts Overflow)
- ATMPTS (Total Attempts)
- USGSECS (Pool Usage Seconds)

SPM01

OM group ECANRMAN was introduced in SPM01 (CSP09).

Registers

The following registers display on the MAP terminal:

ECANLOW	ECANLOST	ECANDENY	ECANFAIL	
ECANUTIL	ECANHI	ATMPTSOV	ATMPTS	USGSECS

The following illustrates a request for ECAN resources.

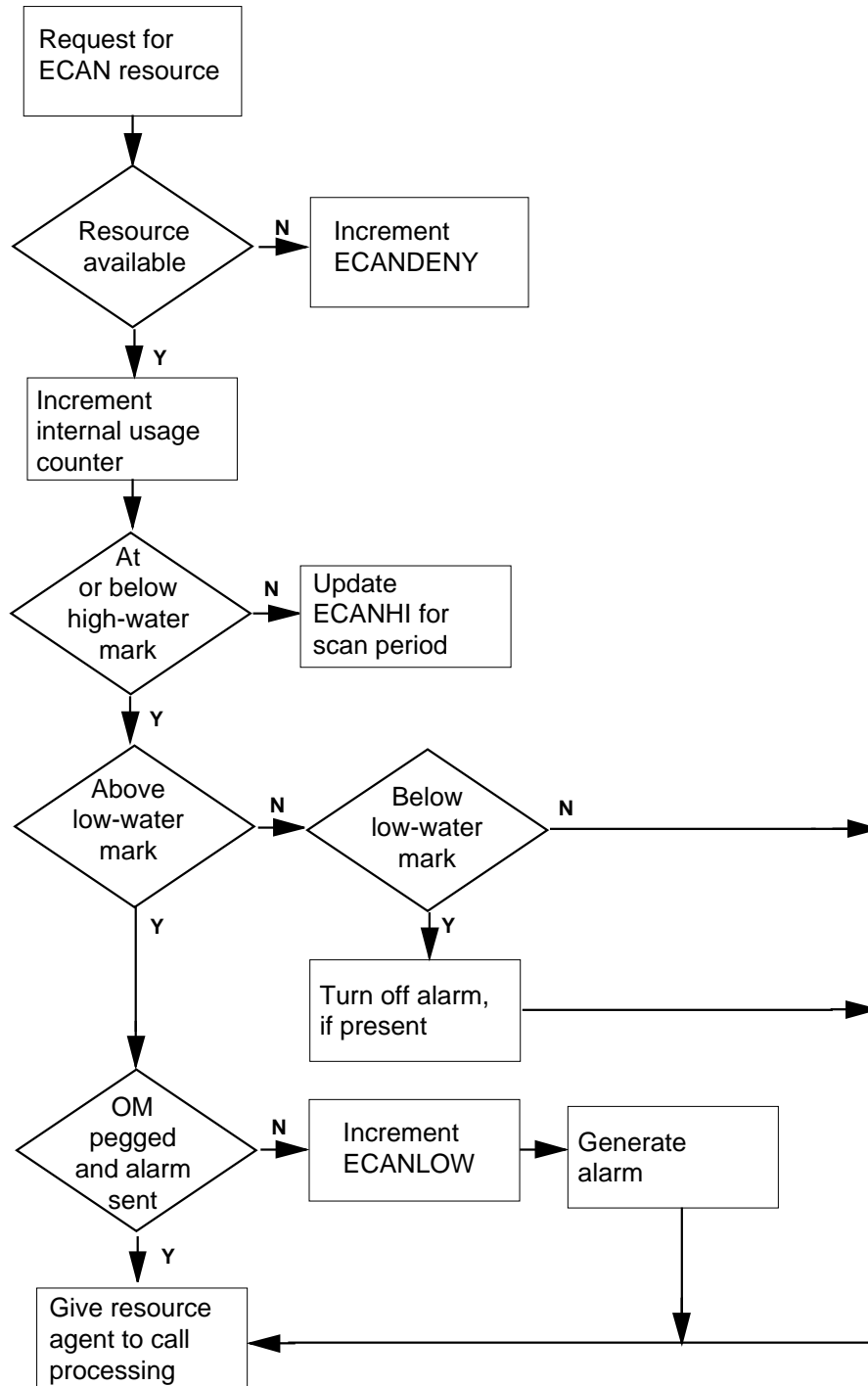
OM group ECANRMAN (continued)

OM group ECANRMAN (continued)

The following illustrates a request for ECAN resources and involves register ECANFAIL.



The following illustrates a request for ECAN resources and involves register ECANLOST.

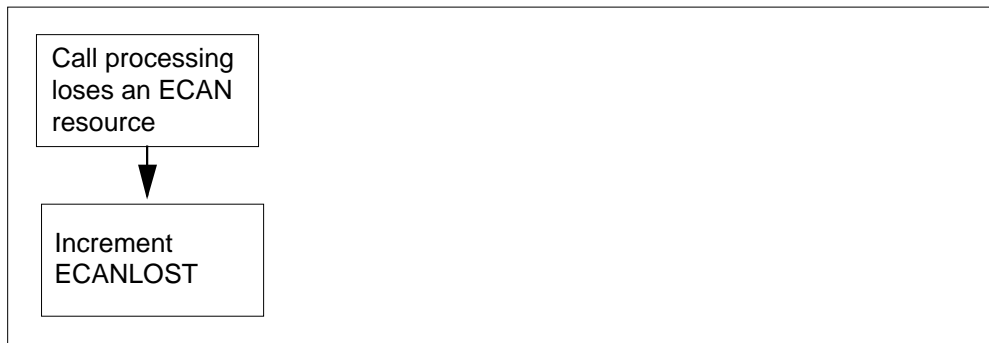

Group structure

OM group ECANRMAN

Key field:

nil_type_id

Info field:

sots_NODE_INFO

Datafill

For all echo cancellers, verify that a corresponding VSP RM is datafilled in SPM table MNCKTPAK.

Associated OM groups

OM group DSPRMAN contains OMs for other resource types existing on SPM nodes.

OM group ECANRMAN (continued)

ECANRMAN and DSPRMAN contain OMs for resources managed by SPM resource management.

Validation formula

There is no mathematical relationship between the groups ECANRMAN and DSPRMAN.

For the ECAN set of resources, or the set of resources of any type, there is a mathematical relationship between the number of resources free and in-use. (These are not output as OMs. They are visible by a MAP interface.)

If the low-water-mark threshold is 60% of the total number of resources in the pool, when the threshold is reached, the number of resources in use must be equal to 60%. The number free must be 40% of the total number in the pool.

Associated products

SPM OC-3 IEC Trunking, NA100SPM

Associated functional groups

Not applicable

Associated functionality codes

Not applicable

OM logic flow or pseudocode

The following functionality is provided by the OM Base subsystem of DMS and the SPM OM Transport System (SOTS).

The OMs in the active registers are swapped into the holding registers and the active registers are cleared at the beginning of every collection period. Peripheral are asked to send their OM data up to the CM one minute before the end of the current collection period. At the CM they are placed for the remainder of this last minute into the active registers for the group. At the end of the last minute, the CM OM Base system swaps the active registers in to the holding registers. Therefore, on the CM, one sees all zeros in the group's active registers when using the OMSHOW tool.

Usually, at the CM and using OMSHOW, a user sees the holding registers for the group that represent what has taken place during the last collection period. To observe the measurements for the active registers, the telco user should remlogin to the active CEM of the SPM of interest, change to directory RESMAN and issue the command PRINTOMS.

OM group ECANRMAN (continued)

The OMs are cleared at the beginning of every collection period. Therefore, they represent what has taken place during the last collection period.

The following rules apply if an ECAN resource is requested from SPM resource management to be attached to a trunk:

- If the increment to the register for total attempts, ATMPTS, would cause overflow of the register, then the total attempts overflow register, ATMPTSOV, is incremented and the register ATMPTS is set to zero. Otherwise, ATMPTS is incremented.
- If no resources are available for use in the ECAN pool, resource management (RMAN) increments the ECANDENY register.
- If a resource is available in the ECAN pool, resource management increments an internal usage counter for the total number of resources allocated from the pool.
- If the usage counter is greater than the current value of the high-water-mark (maximum number of resources allocated at any one instance during the last scan period), resource management updates the high-water-mark register (field) to be equal to the current number of allocated resources.
- If an ECAN resource has been allocated/given to a user (call processing) and if the number of free resources in the pool is at or below the low-water-mark threshold on the ECAN pool, resource management increments the ECANLOW register (field). An alarm also generates.

An ECAN resource agent gets a message from the resource it represents when it has failed to converge (cancel the echo). This is due either to the limits of its parameters as set in table SPMECAN or to an algorithm failure. If this occurs, resource management increments the ECANFAIL register.

If resource management must take an ECAN resource away from a user (call processing) due to an RM sparing action, it increments the ECANLOST register.

When the one second timer for ECAN usage expires, if at least one ECAN resource is in use (allocated), then the register for number of seconds of ECAN pool usage (USGSECS) is incremented.

All non-restorable resources are always lost in sparing actions. ECAN is a restorable resource, so it is not lost in the event of sparing an RM. When a controlled sparing action occurs, resources are gracefully released by call processing, so they are not lost. In the event of an RM failure (critical fault) with no spare RM, all resources on the failed RM are lost.

OM group ECANRMAN (continued)

A “non-restorable resource,” if spared, cannot be restored to call processing; therefore, it is lost to call processing. However, it is added to the resource pools when the RM it resides on (got moved to) comes in service (such as, DTMF, COT, and TONESYN. A “restorable resource,” if spared, can be restored to call processing with the same state it was in prior to the sparing action (such as, ECAN and DTMF when they are used in FTR mode).

“Controlled sparing” (also called “unforced sparing”) is a type of sparing action that occurs if a command is entered at the MAP terminal to deload of an RM. The non-restorable resources on the RM are deloaded before the RMs are spared. “Uncontrolled sparing” is a sparing action that occurs as the result of a hardware fault that is detected by RM device maintenance or if a sparing action has been forced at the MAP terminal. The non-restorable resources on the RM are not deloaded before the RM hardware is spared.

“Deloading resources” refers to waiting for resources to be released by call processing before taking a sparing action. Deloading an RM refers to the process of allowing resources in use to be released under normal call processing circumstances. Deloading does not take place in an uncontrolled sparing scenario.

Register ECANLOW

Expanded register name: Echo cancellation resource low-water-mark threshold violations on the node-level ECAN pool

This register counts the low-water-mark threshold violations on the SPM node-level pool of ECAN resources since the last collection period. Crossing the threshold once indicates a potential for resource exhaustion on the node. Crossing the threshold more than once in a collection period indicates the user (call processing) is operating around the threshold for extended periods.

Operating around the threshold for extended periods indicates insufficient ECAN resources on the node. The corrective action is to provision another RM or another SPM to support the call rate and call mix.

Register ECANLOW release history

Register ECANLOW was introduced in SPM01 (CSP09).

Associated registers

ECANUTIL

The percentage of ECANs at the node level should be considered high whenever the low-water-mark threshold is crossed. Compute it using the

OM group ECANRMAN (continued)

threshold value and the queue size obtained from the SPM node-level MAP terminal.

Associated logs

SPM350 is an alarmed log and has a default status of minor.

Extension registers

Not applicable

Register ECANLOST

Expanded register name: ECAN resources lost or taken away from call processing

This register counts the ECAN resources taken away from users of SPM resource management (such as call processing) due to sparing actions.

Register ECANLOST release history

Register ECANLOST was introduced in SPM01 (CSP09).

Associated registers

Not applicable

Associated logs

Not applicable

Extension registers

Not applicable

Register ECANDENY

Expanded register name: ECAN requests denied

Register ECANDENY release history

Register ECANDENY was introduced in SPM01 (CSP09).

Associated registers

ECANUTIL should be 100% before ECANDENY increments the peg register.

Associated logs

Not applicable

Extension registers

Not applicable

OM group ECANRMAN (continued)

Register ECANFAIL

Expanded register name: ECAN failures to converge SOS events

An ECAN resource is self-monitoring in that it continuously monitors its own performance. When a sustained degradation in performance is detected, an ECAN resource sends an SOS message to its resource agent. The resource agent then pegs the ECANFAIL OM.

Register ECANFAIL release history

Register ECANFAIL was introduced in SPM01 (CSP09).

Associated registers

Not applicable

Associated logs

A log for SOS messages outputs the status message and includes an identification of the resource, on which RM it was located, and on which SPM it was located. Other call processing data is output also.

Extension registers

Not applicable

Register ECANUTIL

Expanded register name: Percent utilization of ECANs

ECANUTIL calculates the percentage of the total ECAN resources in the node-level pool allocated to users of resource management (such as call processing). ECANUTIL is the average percentage utilization for all scan periods during a collection/transfer period. ECANUTIL does not indicate the total number in use at the end of a scan or transfer period.

Note: It is output as a peg register at the CM, but it represents ECAN resource usage. As far as the OM subsystem is concerned, it is only a pegged count. The percentage statistic is computed locally on the SPM by the resource management at 100-second scan intervals. A local peg is updated, and at the end of the collection period, the average of averages for all scan intervals is output at the CM as a peg register.

Register ECANUTIL release history

Register ECANUTIL was introduced in SPM01 (CSP09).

Associated registers

Not applicable

OM group ECANRMAN (continued)

Associated logs

Not applicable

Extension registers

Not applicable

Register ECANHI

Expanded register name: High-water-mark for ECAN usage

ECANHI counts the highest number of ECAN resources allocated from the node-level pool during a collection/transfer period. Its value starts at zero at the beginning of each collection/transfer period for the node. An update occurs when there is a new high-water-mark in the collection period. This occurs when the total number of resources allocated from the ECAN pool exceeds the previous high-water-mark for the pool.

Register ECANHI release history

Register ECANHI was introduced in SPM01 (CSP09).

Associated registers

Not applicable

Associated logs

Not applicable

Extension registers

Not applicable

Register ATMPTSOV

Expanded register name: Total Attempts Overflow

ATMPTSOV is a count of the total number of times during the collection period (OM transfer period) the register ATMPTS has overflowed. That is, it has exceeded the maximum size, 65535, of an OM register. Therefore, the actual number of total attempts to allocate ECANs on the SPM is given by the following formula:

$$(\text{ATMPTSOV} * 65535) + \text{ATMPTS}$$

Register ATMPTSOV release history

Register ATMPTSOV was introduced in SP11 (CSP11).

OM group ECANRMAN (continued)

Associated registers

ATMPTS

Validation formula

Assuming that the number of ECAN resources in the ECAN pool on an SPM remains constant during a collection period, the following formula is true:

$$((\text{ATMPTSOV} * 65535) + \text{ATMPTS}) = (\text{ECANUTIL} * \text{The number of ECAN resources in the SPM ECAN pool}) + \text{ECANDENY}$$

Note: The number of ECANs on an SPM can be seen by issuing the command LISTRES (List Resources) at the SPM level of the MAP. Post the SPM at the MAP then enter the LISTRES command.

Associated logs

Not applicable

Extension registers

Not applicable

Register ATMPTS

Expanded register name: Total Attempts

ATMPTS is a count of the total number of attempts to allocate (get) an echo canceller resource from the ECAN pool on the SPM. It includes all successful allocations, unsuccessful allocation, including denials (due to no ECANs being free) and attempts to allocate when the pool is empty or non-existent. (This last case should never occur if datafill was done correctly and there are VSP RMs inservice when a user of RMAN attempts to make calls requiring ECANs.)

Register ATMPTS release history

Register ATMPTS was introduced in SP11 (CSP11).

Associated registers

ATMPTSOV

Validation formula

Assuming that the number of ECAN resources in the ECAN pool on an SPM remains constant during a collection period, the following formula is true:

OM group ECANRMAN (end)

$((\text{ATMPTSOV} * 65535) + \text{ATMPTS}) = (\text{ECANUTIL} * \text{The number of ECAN resources in the SPM ECAN pool}) + \text{ECANDENY}$

Note: The number of ECANs on an SPM can be seen by issuing the command LISTRES (List Resources) at the SPM level of the MAP. Post the SPM at the MAP then enter the LISTRES command.

Associated logs

Not applicable

Extension registers

ATMPTSOV is the overflow (extension) register.

Register USGSECS

Expanded register name: Usage Seconds

USGSECS is a count of the total of seconds during the collection period for which at least one ECAN was in use (allocated). It is a usage register, that can be used to determine how much the ECAN pool was used during the collection period.

Register ATMPTS release history

Register USGSECS was introduced in SP11 (CSP11).

Associated registers

ECANUTIL is another OM to indicate usage of ECAN resources on an SPM node.

Validation formula

Not applicable

Associated logs

Not applicable

Extension registers

Not applicable

OM group EIUETHER

OM description

Ethernet Interface Unit (EIU) Ethernet

The EIUETHER operational measurement (OM) group allows access to traffic information at the Media Access Control (MAC) protocol level. The information provided by this OM group includes the total count of incoming and outgoing packets and bytes at the MAC interface in a long-word format. The counts accumulate over the OM transfer period. This OM group can be used for traffic measurements of EIU.

Release history

OM group EIUETHER was introduced in BCS34.

Registers

OM group EIUETHER registers display as follows:

EIURXBYT	EIURXBY2	EIURXPKT	EIURXPK2
EIURXBCA	EIURXBC2	EIURXDIS	EIURXDI2
EIURXERR	EIURXER2	EIURXUPP	EIURXUP2
EIUTXBYT	EIUTXBY2	EIUTXPKT	EIUTXPK2
EIUTXBCA	EIUTXBC2	EIUTXDIS	EIUTXDI2
EIUTXERR	EIUTXER2		

Group structure

OM group EIUETHER provides one tuple per IEU.

Key field:

none

Info field:

NCMNODE_INFO

Associated OM groups

None

Associated products

None

Register EIURXBYT

Register EIU MAC Receive BYTeS

OM group EIUETHER (continued)

EIURXBYT is the number of bytes received on the Media Access Control (MAC) interface, including frame check sequence bytes. This register, along with others in this group, is used for Ethernet Interface Unit (EIU) traffic and performance measurements.

Register EIURXBYT release history

Register EIURXBYT was introduced in BCS34.

Associated registers

None

Associated logs

None

Extension register

EIURXBY2

Register EIURXPKT

Register EIU MAC Receive PacKeTs

EIURXPKT is the number of unicast packets delivered to a higher-layer protocol on an Ethernet Interface Unit (EIU). This register, along with others in this group, is used for EIU traffic and performance measurements.

Register EIURXPKT release history

Register EIURXPKT was introduced in BCS34.

Associated registers

None

Associated logs

None

Extension register

EIURXP2

Register EIURXBCA

Register EIU MAC Receive BroadCAsts

EIURXBCA is the number of broadcast packets delivered to a higher-layer protocol. This register, along with others in this group, is used for Ethernet Interface Unit (EIU) traffic and performance measurements.

OM group EIUETHER (continued)

Register EIURXBCA release history

Register EIURXBCA was introduced in BCS34.

Associated registers

None

Associated logs

None

Extension register

EIURXBC2

Register EIURXDIS

Register EIU MAC Receive DIScards

EIURXDIS is the minimum number of received packets chosen to be discarded even though no errors in the packet are detected. Possible reason for discarding a packet is due to resource limitations in the Ethernet Interface Unit (EIU) (no free buffers to hold a received packet). This register, along with others in this group, is used for EIU traffic and performance measurements.

Register EIURXDIS release history

Register EIURXDIS was introduced in BCS34.

Associated registers

None

Associated logs

None

Extension register

EIURXDI2

Register EIURXERR

Register EIU MAC Receive ERRor

EIURXERR is the number of received packets that contained errors. This register, along with others in this group, is used for Ethernet Interface Unit (EIU) traffic and performance measurements.

Register EIURXERR release history

Register EIURXERR was introduced in BCS34.

OM group EIUETHER (continued)

Associated registers

None

Associated logs

None

Extension register

EIURXER2

Register EIURXUPP

Register EIU MAC Receive Unknown Protocol Packets

EIURXUPP is the number of packets discarded because of an unknown or unsupported protocol. This register, along with others in this group, is used for Ethernet Interface Unit (EIU) traffic and performance measurements.

Register EIURXUPP release history

Register EIURXUPP was introduced in BCS34.

Associated registers

None

Associated logs

None

Extension register

EIURXUP2

Register EIUTXBYT

Register EIU MAC Transmit BYTes

EIUTXBYT is the number of bytes transmitted out of the Media Access Control (MAC) interface, including frame check sequence bytes. This register, along with others in this group, is used for Ethernet Interface Unit (EIU) traffic and performance measurements.

Register EIUTXBYT release history

Register EIUTXBYT was introduced in BCS34.

Associated registers

None

OM group EIUETHER (continued)

Associated logs

None

Extension register

EIUTXBY2

Register EIUTXPKT

Register EIU MAC Transmit PacKeTs

EIUTXPKT is the number of packets that higher-layer protocols requested for transmission to a unicast Media Access Control (MAC) address. This register, along with others in this group, is used for Ethernet Interface Unit (EIU) traffic and performance measurements.

Register EIUTXPKT release history

Register EIUTXPKT was introduced in BCS34.

Associated registers

None

Associated logs

None

Extension register

EIUTXPK2

Register EIUTXBCA

Register EIU MAC Transmit BroadCAsts

EIUTXBCA is the number of packets that higher-layer protocols requested for transmission to a broadcast Media Access Control (MAC) address. This register, along with others in this group, is used for Ethernet Interface Unit (EIU) traffic and performance measurements.

Register EIUTXBCA release history

Register EIUTXBCA was introduced in BCS34.

Associated registers

None

Associated logs

None

OM group EIUETHER (end)

Extension register

EIUTXBC2

Register EIUTXDIS

Register EIU MAC Transmit DIScards

EIUTXDIS is the number of outbound packets chosen to be discarded even though no errors were detected to prevent transmission. A possible reason for discarding a packet is due to resource limitations in the Ethernet Interface Unit (EIU) (no free buffers to hold a packet). This register, along with others in this group, is used for EIU traffic and performance measurements.

Register EIUTXDIS release history

Register EIUTXDIS was introduced in BCS34.

Associated registers

None

Associated logs

None

Extension register

EIUTXD12

Register EIUTXERR

Register EIU MAC Transmit Error

EIUTXERR is the number of outbound packets that could not be transmitted because of errors. This register, along with others in this group, is used for Ethernet Interface Unit (EIU) traffic and performance measurements.

Register EIUTXERR release history

Register EIUTXERR was introduced in BCS34.

Associated registers

None

Associated logs

None

Extension register

EIUTXER2

OM group ENETMAT

OM description

Enhanced network matrix card (ENETMAT)

The OM group ENETMAT monitors the performance of enhanced network (ENET) matrix cards. Operational measurements for ENET matrix cards are divided into two sets:

- crosspoint (XPT) cards, like NT9X35
- link paddle boards (PB), like NT9X40 and NT9X41

Register ENETMAT contains 12 peg registers that count the following events:

- errors in ENET XPT cards
- faults in ENET XPT cards
- ENET partitioning that occurs because an ENET XPT card is system busy
- ENET partitioning that occurs because an ENET XPT card is manual busy
- peripheral modules (PM) that are isolated because an ENET XPT card is system busy
- PMs that are isolated because an ENET XPT card is manual busy
- errors in ENET link PBs
- faults in ENET link PBs
- ENET partitioning that occurs because an ENET link PB is system busy
- ENET partitioning that occurs because an ENET link PB is manual busy
- PMs that are isolated because an ENET link PB is system busy
- PMs that are isolated because an ENET link PB is manual busy

Register ENETMAT also contains nine use registers that record the following events:

- an XPT card is system busy
- an XPT card is manual busy
- an XPT card is offline
- ENET partitioning occurred because an ENET XPT card is out of service
- a PM is isolated because an ENET XPT card is out of service
- a link PB is system busy
- a link PB is manual busy

OM group ENETMAT (continued)

- ENET partitioning occurs because an ENET link PB is out of service
- a PM is isolated because an ENET link PB is out of service

Release history

The OM group ENETMAT was introduced in BCS31.

BCS34

Registers ENCDPARU and ENPBPAPU are set to zero.

Registers

The OM group ENETMAT registers appear on the MAP terminal as follows:

ENCDEER	ENCDFLT	ENSBCDU	ENMBCDU
ENOFCDU	ENCDFPARU	ENSDFPAR	ENMDFPAR
ENCDFISO	ENSDFISO	ENMDFISO	ENPBERR
ENPBFLT	ENSBPBU	ENMBPBU	ENPBPARU
ENSPBPAR	ENMPBPAR	ENPBISO	ENSPBISO
ENMPBISO			

Group structure

The OM group ENETMAT provides one tuple per office.

Key field:

There are no Key fields.

Info field:

There are no Info fields.

Associated OM groups

The ENETSYS monitors the performance of the ENET system cards.

The ENETPLNK monitors the performance of the ENET peripheral side (P-side) links.

The ENETOCC provides information on the CPU occupancy of each in-service ENET in a DMS-100 family switch.

OM group ENETMAT (continued)**Associated functional groups**

The following functional groups associate with the OM group ENETMAT:

- SuperNode offices that have ENET

Associated functionality codes

The associated functionality codes for the OM group ENETMAT appear in the following table.

Functionality	Code
ENET - Basic	NTXE01AA

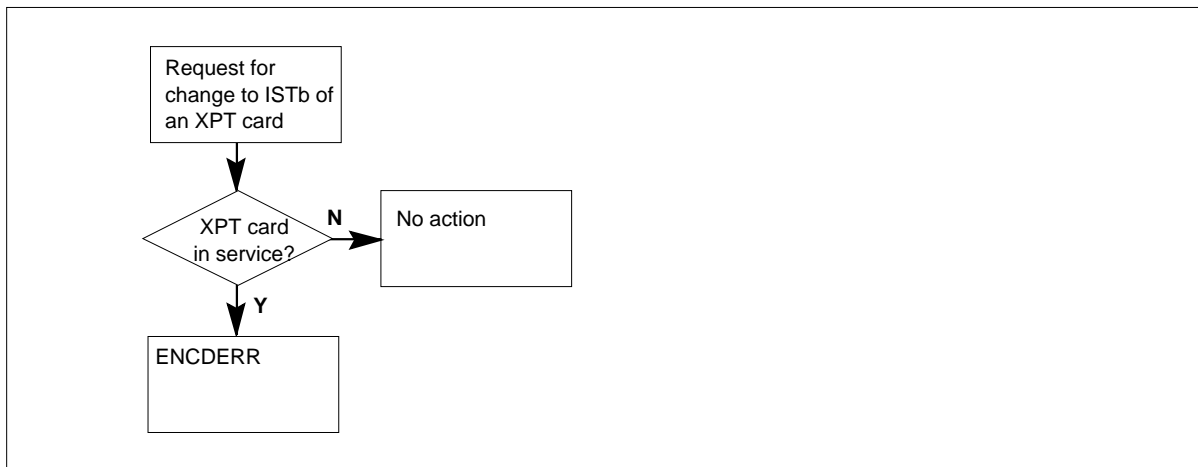
OM group ENETMAT registers: XPT card errors

OM group ENETMAT (continued)

OM group ENETMAT registers: XPT card faults

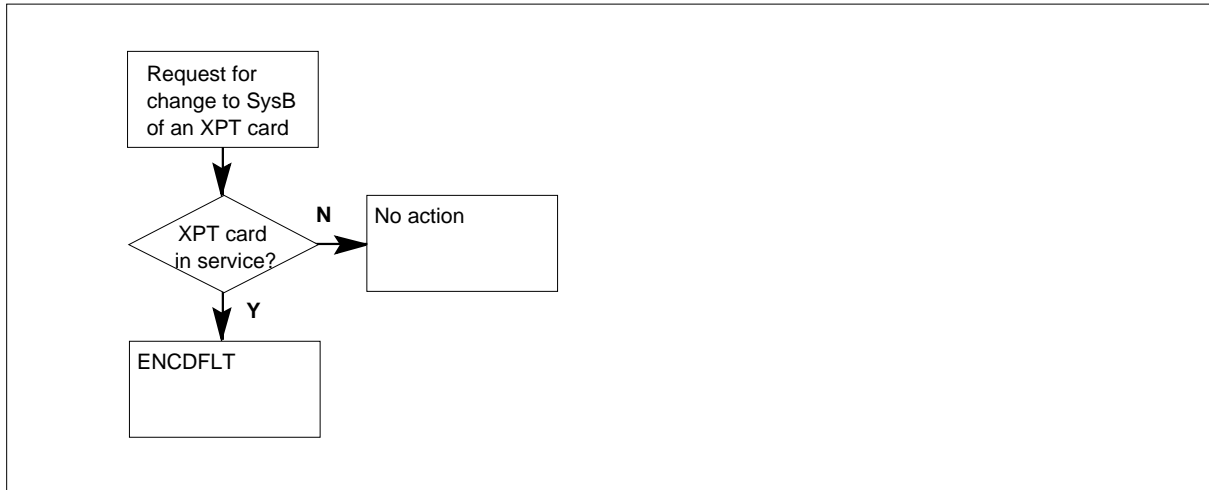

OM group ENETMAT registers: PB error

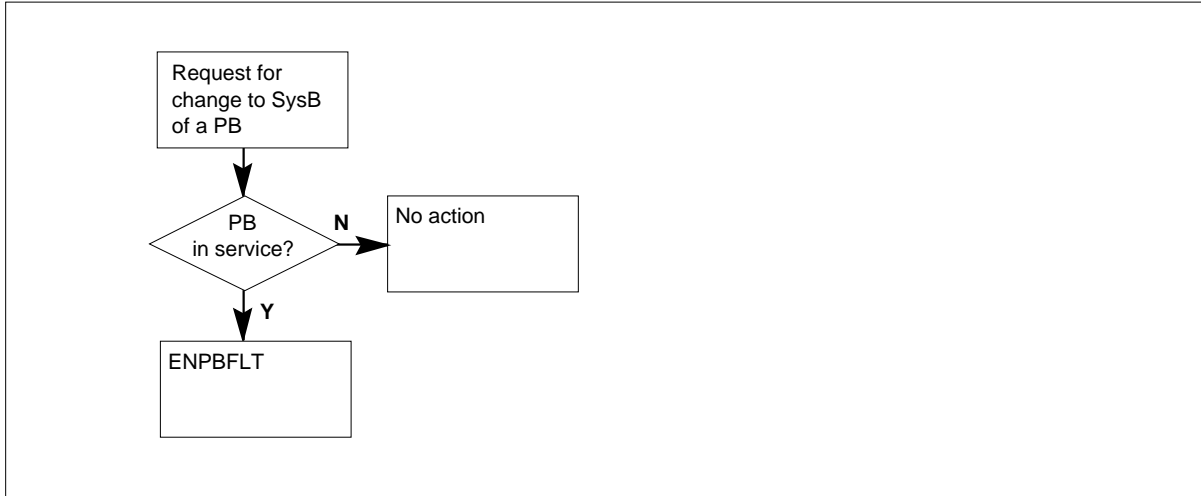
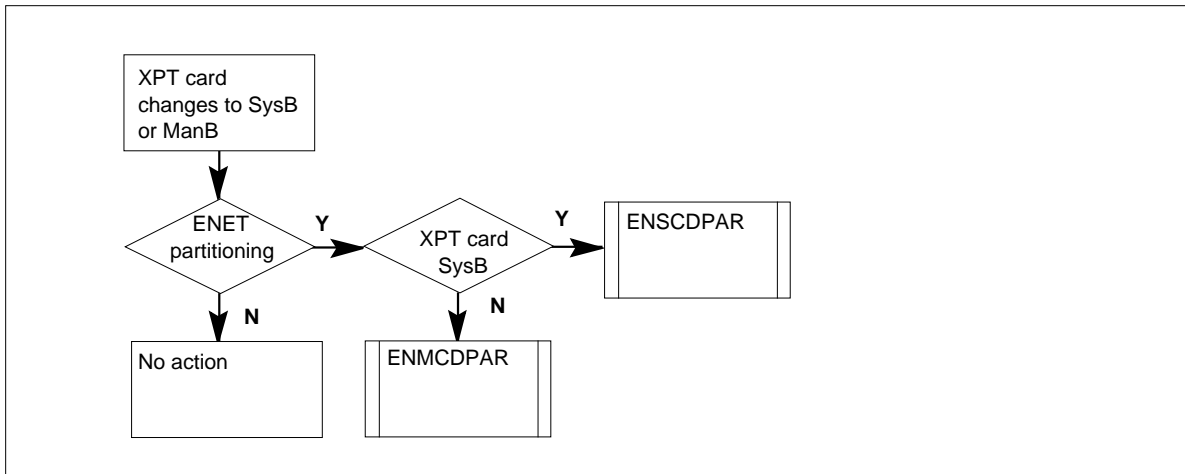

OM group ENETMAT (continued)**OM group ENETMAT registers: PB faults****OM group ENETMAT registers: XPT card ENET partitioning**

OM group ENETMAT (continued)

OM group ENETMAT registers: XPT card PM isolated

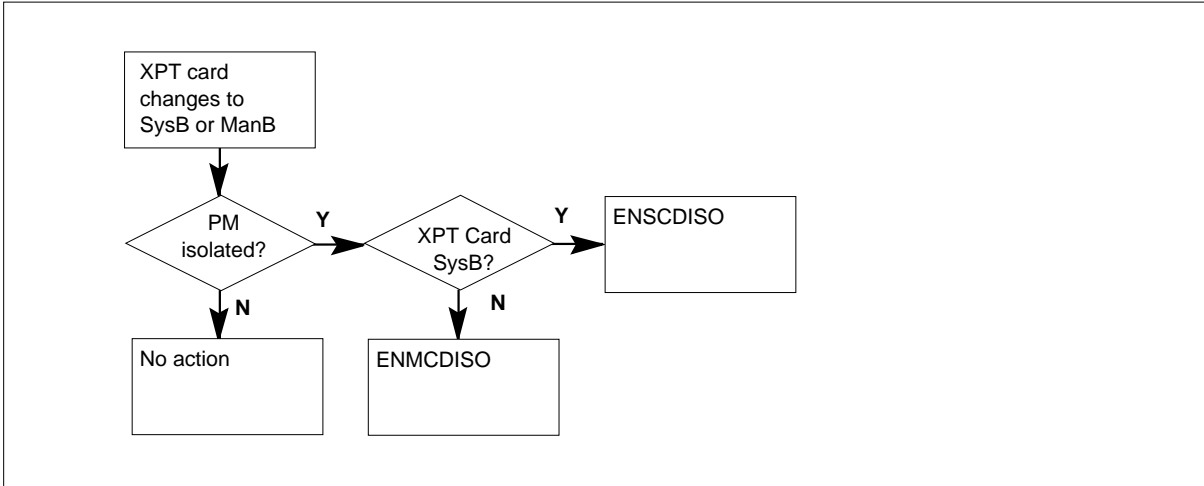

OM group ENETMAT registers: PB ENET partitioning

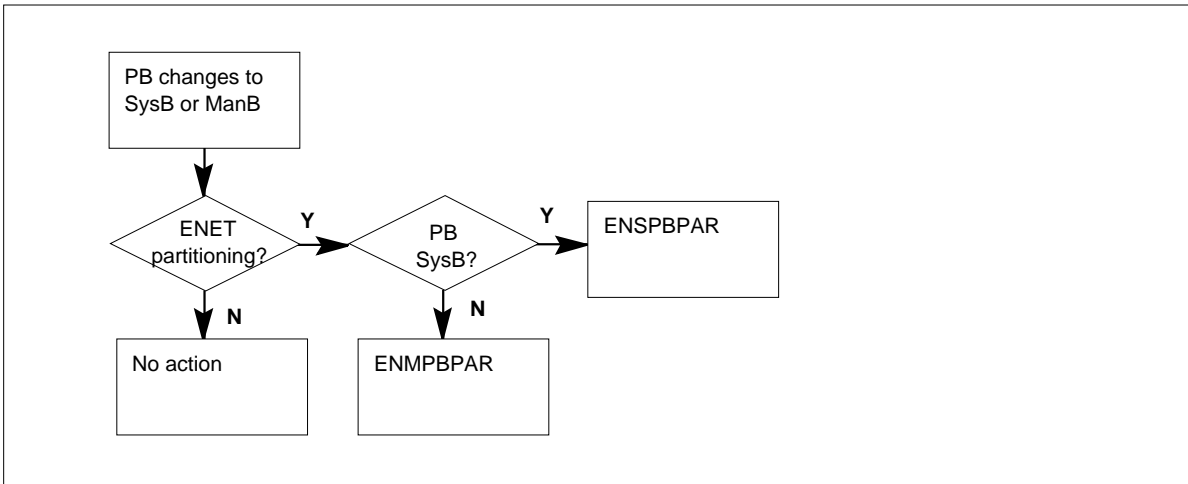

OM group ENETMAT (continued)

OM group ENETMAT registers: PB PM isolated

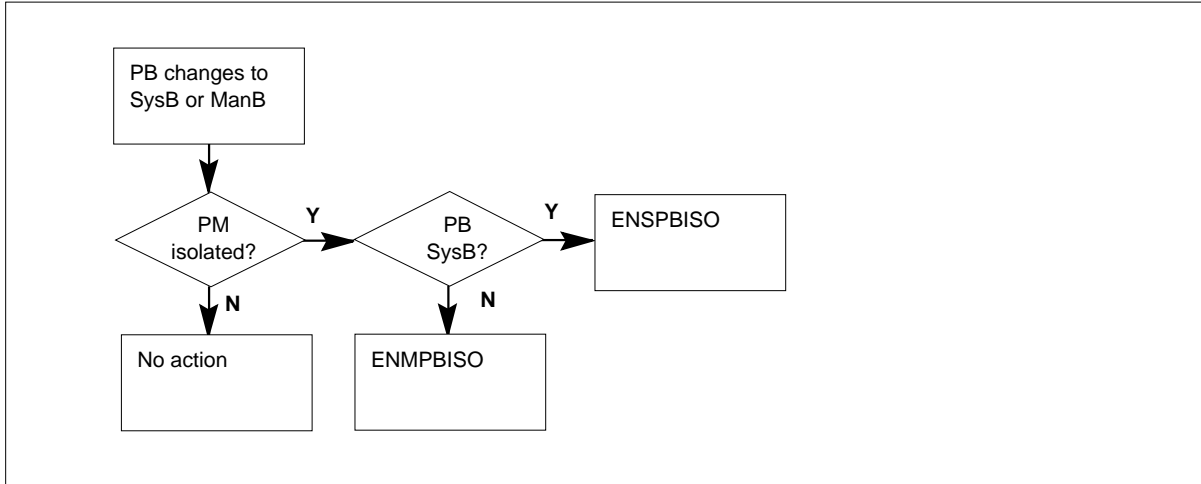

OM group ENETMAT (continued)

OM group ENETMAT registers: XPT card usage registers

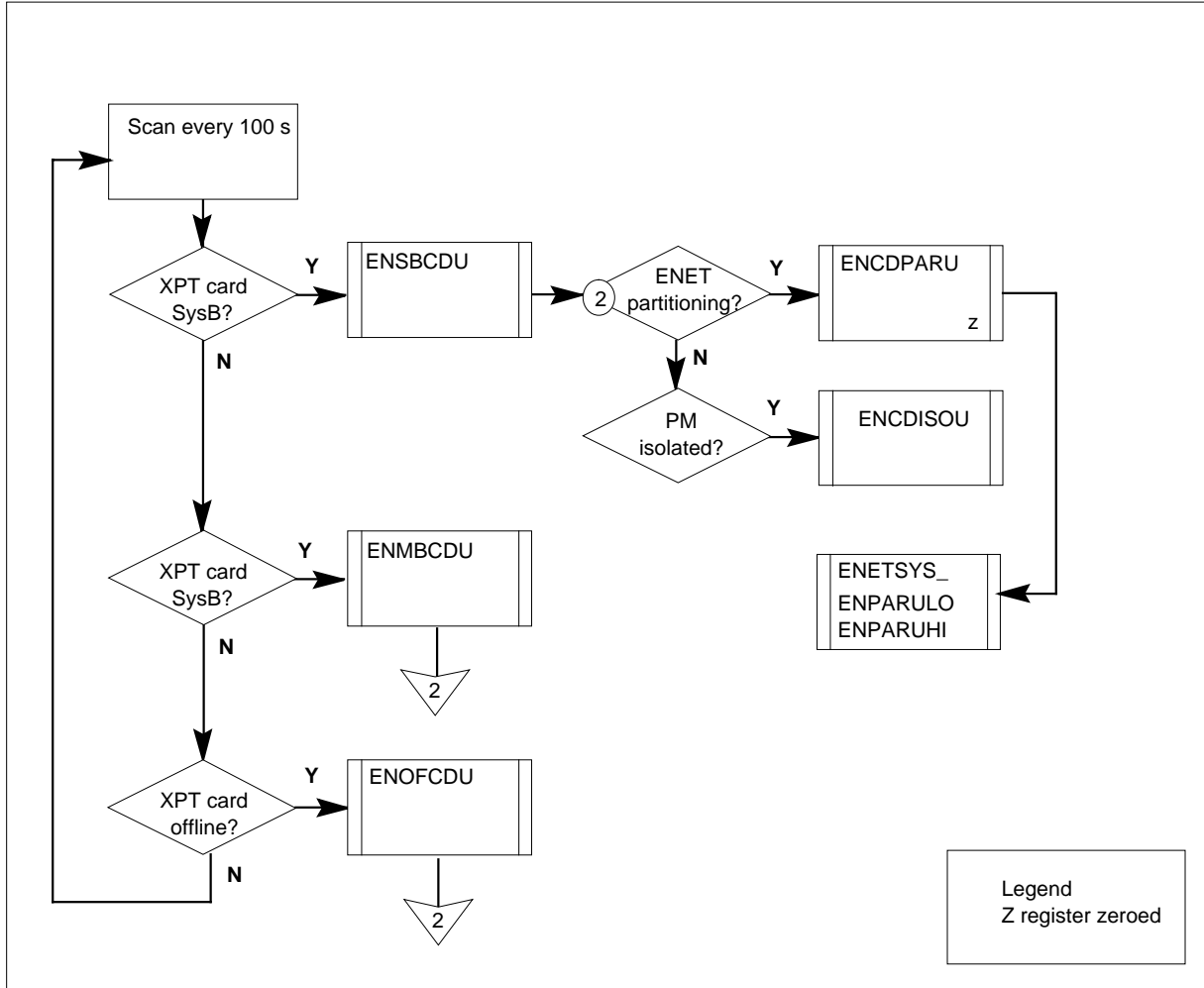

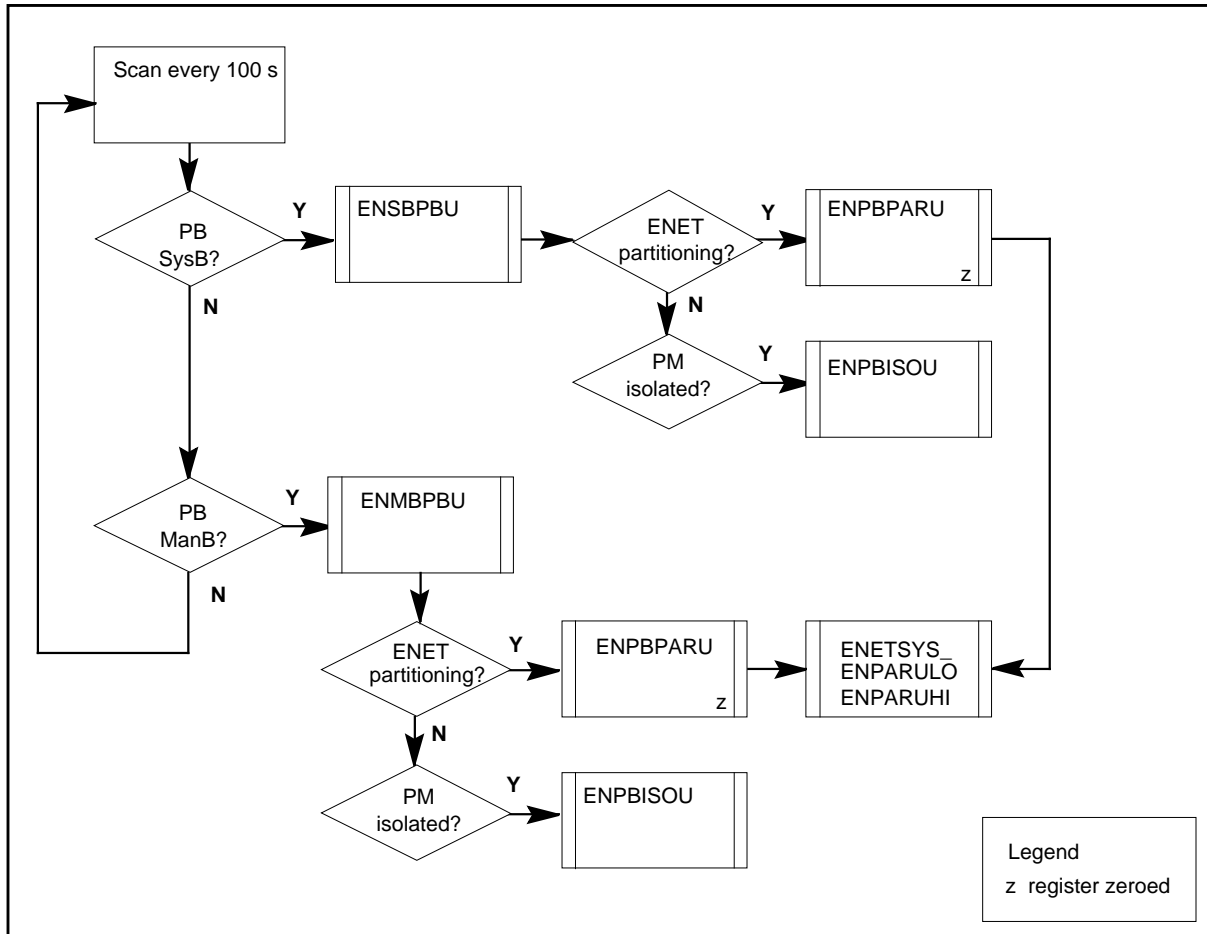
OM group ENETMAT (continued)**OM group ENETMAT registers: PB usage registers****Register ENCDERR**

XPT card errors (ENCDERR)

Register ENCDERR counts errors that the system detects in the operation of the in-service XPT cards of the network.

Register ENCDERR release history

Register ENCDERR was introduced in BCS31.

Associated registers

There are no associated registers.

Associated logs

The system generated ENET208 when the ENET card is set to in-service trouble.

OM group ENETMAT (continued)

Register ENCDFLT

XPT card faults (ENCDFLT)

Register ENCDFLT counts the number of times the system identifies a hard fault in network XPT cards. The system identifies hard faults as a result of self tests. A detected error triggers self tests. The XPT card is set to a system busy status. This status remains until a manual action occurs or until the system initiates a successful recovery.

Register ENCDFLT release history

Register ENCDFLT was introduced in BCS31.

Associated registers

There are no associated registers.

Associated logs

The system generates the ENET203 when an ENET card changes state from in service (OK) to system busy.

Register ENCDISOU

XPT card isolation usage (ENCDISOU)

Register ENCDISOU is a usage register. The system scans the ENET XPT cards every 100 s. Register ENCDISOU records if the system isolates a PM because of out-of-service XPT cards.

An isolated PM does not access the network. Isolation occurs if the last ENET XPT card that connects a PM to the rest of the network goes out of service. If the network goes out of service, the PM becomes central side (C-side) busy.

Register ENCDISOU increases by the number of C-side busy PMs connected to the network. Register ENCDISOU increases if the XPT card and the mate XPT card on the opposite plane are out of service.

Register ENCDISOU release history

Register ENCDISOU was introduced in BCS31.

Associated registers

There are no associated registers.

Associated logs

There are no associated logs.

OM group ENETMAT (continued)

Register ENCDPARU

XPT card partitioning usage (ENCDPARU)

Register ENCDPARU is a usage register. The system scans the ENET XPT cards every 100 s. Register ENCDPARU records if a minimum of one out-of-service XPT card is present on plane 0. Register ENCDPARU also records if a minimum one out-of-service ENET component is present on plane 1.

This out-of-service XPT card and ENET component can partition the network and result in blocked calls. When the system partitions the network, register ENCDPARU increases by the total number of paths that are not accessible. These paths are from the P-side links of the out-of-service link XTP card to other P-side links in the network.

Register ENCDPARU release history

The ENCDPARU was introduced in BCS31.

BCS34

Register ENCDPARU is set to zero. Registers ENETSYS_ENPARUHI and ENETSYS_ENPARULO replace ENCDPARU.

Associated registers

There are no associated registers.

Associated logs

There are no associated logs.

Register ENMBCDU

XPT card manual busy usage (ENMBCDU)

Register ENMBCDU is a usage register. The system scans the ENET XPT cards every 100 s. Register ENMBCDU records if an XPT card is manual busy.

Register ENMBCDU release history

The ENMBCDU was introduced in BCS31.

Associated registers

There are no associated registers.

Associated logs

There are no associated logs.

OM group ENETMAT (continued)

Register ENMBPBU

Link PB manual busy usage

Register ENMBPBU is a usage register. The system scans the ENET link PBs every 100 s. Register ENMBPBU records if a PB is manual busy.

Register ENMBPBU release history

Register ENMBPBU was introduced in BCS31.

Associated registers

There are no associated registers.

Associated logs

There are no associated logs.

Register ENMCDISO

XPT card manual busy isolation (ENMCDISO)

Register ENMCDISO counts in-service ENET XPT cards that become manual busy. The manual busy state causes the isolation of a minimum of one PM.

An isolated PM cannot access the network. Isolation occurs if the last ENET XPT card that connects a PM to the rest of the network goes out of service. The PM becomes C-side busy.

Register ENMCDISO release history

Register ENMCDISO was introduced in BCS31.

Associated registers

There are no associated registers.

Associated logs

The system generates the ENET201 when an ENET card changes state from in service (OK) to manual busy.

Register ENMCDPAR

The XPT card manual busy partitioning (ENMCDPAR)

Register ENMCDPAR counts in-service ENET XPT cards that become manual busy. These cards become manual busy while other ENET components on the opposite plane are out of service. The count can partition the network. A partitioned network results in blocked calls. This condition

OM group ENETMAT (continued)

must be present for a minimum of 100 s before the register increases. This condition must be present as a result of the scanning interval.

Register ENMCDPAR release history

Register ENMCDPAR was introduced in BCS31.

Associated registers

There are no associated registers.

Associated logs

The system generates the ENET201 when an ENET card changes state from in service (OK) to manual busy.

Register ENMPBISO

Link PB manual busy isolation (ENMPBISO)

Register ENMPBISO counts in-service ENET link PBs that become manual busy. The manual busy state causes the isolation of a minimum of one PM.

An isolated PM cannot access the network. An ENET link PB card connects the PM to the rest of the network. If the last ENET link PB card goes out of service, PM isolation occurs. The PM becomes C-side busy.

Register ENMPBISO release history

Register ENMPBISO was introduced in BCS31.

Associated registers

There are no associated registers.

Associated logs

The system generates the ENET201 when an ENET card changes state from in service (OK) to manual busy.

Register ENMPBPAR

Link PB manual busy partitioning (ENMPBPAR)

Register ENMPBPAR counts in-service ENET link PBs that become manual busy. These PBs become manual busy while other ENET components on the opposite plane are out of service. The manual busy state causes the blockage of calls from one PM to other PMs. As a result of the scanning interval, this condition must be present for a minimum of 100 s before the register increases.

OM group ENETMAT (continued)

Register ENMPBPAP release history

Register ENMPBPAP was introduced in BCS31.

Associated registers

There are no associated registers.

Associated logs

The system generates the ENET201 when an ENET card changes state from in service (OK) to manual busy.

Register ENOFCDU

XPT card offline usage (ENOFCDU)

Register ENOFCDU is a usage register. Every 100 s the system scans the ENET XPT cards every 100 s. Register ENOFCDU records if a card is offline.

Register ENOFCDU release history

Register ENOFCDU was introduced in BCS31.

Associated registers

There are no associated registers.

Associated logs

There are no associated logs.

Register ENPBERR

Link PB errors (ENPBERR)

Register ENPBERR counts all errors that the system detects in the operation of the in-service link PBs of the network.

Register ENPBERR release history

Register ENPBERR was introduced in BCS31.

Associated registers

There are no associated registers.

Associated logs

The system generates the ENET208 when an ENET card becomes in-service busy.

Register ENPBFLT

Link PB faults (ENPBFLT)

OM group ENETMAT (continued)

Register ENPBFLT counts the number of times the system identifies a hard fault in the network link PB. Detected errors trigger self tests that result in hard faults. The link PB is set to system busy until a manual action occurs or until the system initiates a successful recovery.

Register ENPBFLT release history

The ENPBFLT was introduced in BCS31.

Associated registers

There are no associated registers.

Associated logs

The system generates the ENET203 when an ENET card changes state from in service (OK) to system busy.

Register ENPBISOU

Link PB isolation usage (ENPBISOU)

The ENPBISOU is a usage register. The system scans the link PBs every 100 s. Register ENPBISOU records if a PM isolates as a result of out-of-service PBs.

An isolated PM cannot access the network. Isolation occurs if the last ENET link PB that connects a PM to the rest of the network goes out of service. The PM becomes C-side busy.

Register ENPBISOU increases if a link PB and the mate link PB on the opposite plane are out of service. Register ENPBISOU increases by the total number of C-side busy PMs that the two link PBs connect to the network.

Register ENPBISOU release history

Register ENPBISOU was introduced in BCS31.

Associated registers

There are no associated registers.

Associated logs

There are no associated logs.

Register ENPBPARU

Link PB partitioning usage (ENPBPARU)

OM group ENETMAT (continued)

Register ENPBPURU is a usage register. A scan occurs every 100 s. Register ENPBPURU records if a minimum of one out-of-service link PB is present on plane 0. Register ENPBPURU also records if a minimum of one out-of-service ENET component is present on plane 1.

The out-of-service link PB and ENET component can partition the network and result in blocked calls. When the system partitions the network, register ENPBPURU increases. Register ENPBPURU increases by the total number of paths that are not accessible. These paths are from the P-side links of the out-of-service link PB to other P-side links in the network.

Register ENPBPURU release history

Register ENPBPURU was introduced in BCS31.

BCS34

Register ENPBPURU is set to zero. The system replaces the ENPBPURU with registers ENETSYS_ENPARUHI and ENETSYS_ENPARULO.

Associated registers

There are no associated registers.

Associated logs

There are no associated logs.

Register ENSBCDU

Crosspoint card system busy usage (ENSBCDU)

Register ENSBCDU is a usage register. The scan rate is 100 s. Register ENSBCDU records if an ENET XPT card is system busy.

Register ENSBCDU release history

Register ENSBCDU was introduced in BCS31.

Associated registers

There are no associated registers.

Associated logs

There are no associated logs.

Register ENSBPBU

Link paddle board (PB) system busy usage (ENSBPBU)

OM group ENETMAT (continued)

Register ENSBPBU is a usage register. The scan rate is 100 s. Register ENSBPBU records if an ENET link PB is system busy.

Register ENSBPBU release history

Register ENSBPBU was introduced in BCS31.

Associated registers

There are no associated registers.

Associated logs

There are no associated logs.

Register ENSCDISO

Crosspoint (XPT) card system busy isolation

Register ENSCDISO counts in-service ENET XPT cards that become system busy. The system busy state causes the isolation of a minimum of one PM.

An isolated PM cannot access the network. Isolation occurs if the last ENET XPT card that connects a PM to the rest of the network goes out of service. The PM becomes C-side busy.

Register ENSCDISO release history

Register ENSCDISO was introduced in BCS31.

Associated registers

There are no associated registers.

Associated logs

The system generates the ENET203 when an ENET card changes state from in service (OK) to system busy.

Register ENSCDPAR

Crosspoint (XPT) card system busy partitioning (ENSCDPAR)

Register ENSCDPAR counts in-service ENET XPT cards that become system busy. These cards become system busy when other ENET components on the opposite plane are out of service. This condition can partition the network. A partitioned network results in blocked calls. A 100 s interval must occur between these events for the register to increase.

Register ENSCDPAR release history

Register ENSCDPAR was introduced in BCS31.

OM group ENETMAT (continued)

Associated registers

There are no associated registers.

Associated logs

The system generates the ENET203 when an ENET card changes state from in service (OK) to system busy.

Register ENSPBISO

Link paddle board (PB) system busy isolation (ENSPBISO)

Register ENSPBISO counts in-service ENET link PBs that become system busy. The system busy state causes the isolation a minimum of one PM.

An isolated PM cannot access the network. Isolation occurs if the last ENET link PB that connects a PM to the rest of the network goes out of service. The PM becomes C-side busy.

Register ENSPBISO release history

Register ENSPBISO was introduced in BCS31.

Associated registers

There are no associated registers.

Associated logs

The system generates the ENET203 when an ENET card changes state from in service (OK) to system busy.

Register ENSPBPAP

Link paddle board (PB) system busy partitioning (ENSPBPAP)

The ENSPBPAP counts in-service ENET link PBs that become system busy. The PBs become system busy when other ENET components on the opposite plane are out of service. The system busy state causes the blockage of calls from one PM to the other PMs. An interval of 100 s must occur between these events for the register to increase.

Register ENSPBPAP release history

Register ENPBPAP was introduced in BCS31.

Associated registers

There are no associated registers.

OM group ENETMAT (end)

Associated logs

The system generates the ENET203 when an ENET card changes state from in service (OK) to system busy.

OM group ENETOCC

OM description

ENET occupancy (ENETOCC)

The OM group ENETOCC provides information about the central processing unit (CPU) occupancy of in-service enhanced network (ENET). The OM group ENETOCC provides information on each ENET in a DMS-100 family switch. Each ENET CPU sends occupancy information to the computing module (CM) every 60 s. The CM copies this information in to the OM registers.

The ENETOCC contains six registers that record the use of the ENET CPU by:

- call processing-related processes
- scheduler-related processes
- system-related processes
- maintenance-related processes
- background-related processes
- idler class processes

Release history

The OM group ENETOCC was introduced in BCS31.

Registers

The OM group ENETOCC registers appear on the MAP terminal as follows:

ENCPOCC	ENSCHED	ENFORE	ENMAINT
ENBKG	ENIDLE		

Group structure

The OM group ENETOCC provides one tuple for each ENET card in the office.

Key field:

There are no Key fields.

Info field:

There are no Info field.

Associated OM groups

The ENETSYS monitors the performance of the ENET system cards.

OM group ENETOCC (continued)

The ENETMAT monitors the performance of the ENET matrix cards.

The ENETPLNK monitors the performance of the ENET peripheral side (P-side) links.

Associated functional groups

The following functional groups associate with the OM group ENETOCC:

- SuperNode offices that have ENET

Associated functionality codes

The associated functionality codes for the OM group ENETOCC appear in the following table.

Functionality	Code
Enhanced Network—Basic	NTXE01AA

Register ENBKG

Background occupancy (ENBKG)

Register ENBKG records if the ENET CPU holds background-related processes. Examples of background-related processes are routine maintenance logs, service orders, OM accumulation and audits.

At the beginning of the transfer period, ENBKG is set to zero. The occupancy value for the ENET CPU background transfers from the ENET node to the CM node every 60 s. The OM system samples the background occupancy value stored on the CM every 100 s. The 100 s is the slow sample period. The OM system accumulates the samples over the transfer period.

To obtain the percentage of ENET CPU occupancy attributed to background-related processes, perform the following calculation. Divide the ENBKG register value by the number of slow samples from the transfer period.

If a sample dump of OM group ENETOCC appears as follows:

OM group ENETOCC (continued)

```

CLASS:ACTIVE START:1996/04/24 17:30:00WED; STOP:1996/04/24 17:33:01WED;
SLOWSAMPLES:      2 ; FASTSAMPLES:      18 ;

INFO (ENETOCC_PLANE_SHELF)

      ENCPOCC   ENSCHED   ENFORE   ENMAINT   ENBKG   ENIDLE
0           2           0         0         58       2       106

```

The percentage of ENET CPU (on plane 0 shelf 0) occupancy attributed to background-related processes for the transfer period is $(2/2) = 1\%$

Register ENBKG release history

Register ENBKG was introduced in BCS31.

Associated registers

There are no associated registers.

Associated logs

There are no associated logs.

Register ENCPOCC

Call processing occupancy (ENCPOCC)

Register ENCPOCC records if the ENET CPU holds call processing-related processes.

At the beginning of the transfer period, register ENCPOCC is set to zero. The CPU call processing occupancy value for the ENET transfers from the ENET node to the CM node every 60 seconds. The OM system samples the call processing occupancy value stored on the CM every 100 s. One hundred seconds is the slow sample period. The OM system accumulates the samples over the transfer period.

To obtain the percentage of ENET CPU occupancy attributed to call processing-related processes, perform the following calculation. Divide the ENCPOCC register value by the number of slow samples from the transfer period.

If a sample dump of OM group ENETOCC appears as follows:

OM group ENETOCC (continued)

```

CLASS:ACTIVE START:1996/04/24 17:30:00WED; STOP:1996/04/24 17:33:01WED;
SLOWSAMPLES:      2 ; FASTSAMPLES:      18 ;
INFO  (ENETOCC_PLANE_SHELF)
      ENCPOCC  ENSCHED  ENFORE  ENMAINT  ENBKG  ENIDLE
0          0          0          0          0          0
          2          20          12          58          2          106

```

The percentage of ENET CPU (on plane 0 shelf 0) occupancy attributed to call processing-related processes for the transfer period is $(2/2) = 1\%$

Register ENCPOCC release history

Register ENCPOCC was introduced in BCS31.

Associated registers

There are no associated registers.

Associated logs

There are no associated logs.

Register ENFORE

System occupancy (ENFORE)

Register ENFORE records system-related processes occupy the ENET CPU. Examples of system-related processes are sanity checking, or system-critical work that requires immediate response.

At the beginning of the transfer period, register ENFORE is set to zero. The system occupancy for the ENET CPU transfers from the ENET node to the CM node every 60 seconds. The OM system samples the system occupancy value stored on the CM every 100 seconds. The slow sample period is 100 s. The OM system accumulates the samples over the transfer period.

To obtain the percentage of ENET CPU occupancy attributed to system-related processes perform the following calculation. Divide the ENFORE register value by the number of slow samples from the transfer period.

If a sample dump of OM group ENETOCC appears as follows:

OM group ENETOCC (continued)

```

CLASS:ACTIVE START:1996/04/24 17:30:00WED; STOP:1996/04/24 17:33:01WED;
SLOWSAMPLES:      2 ; FASTSAMPLES:      18 ;

INFO (ENETOCC_PLANE_SHELF)

      ENCPOCC   ENSCHED   ENFORE   ENMAINT   ENBKG   ENIDLE
0
      2         20       12       58       2       106

```

The percentage of ENET CPU (on plane 0 shelf 0) occupancy attributed to system-related processes for the transfer period is $(12/2) = 6\%$

Register ENFORE release history

Register ENFORE was introduced in BCS31.

Associated registers

There are no associated registers.

Associated logs

There are no associated logs.

Register ENIDLE

Idler occupancy (ENIDLE)

Register ENIDLE records if the ENET CPU performs idler class processes. These processes run when other processes do not run.

At the beginning of the transfer period, the system sets the ENIDLE to zero. The system transfers the ENET CPU idler occupancy value from the ENET node to the CM node every 60 s. The OM system samples idler occupancy value stored on the CM every 100 s. The slow sample period is 100 s. The OM system accumulates the samples over the transfer period.

To obtain the percentage of ENET CPU occupancy attributed to idler-related processes, perform the following calculation. Divide the ENIDLE register value by the number of slow samples from the transfer period.

If a sample dump of OM group ENETOCC appears as follows:

OM group ENETOCC (continued)

```

CLASS:ACTIVE START:1996/04/24 17:30:00WED; STOP:1996/04/24 17:33:01WED;
SLOWSAMPLES:      2 ; FASTSAMPLES:      18 ;
INFO  (ENETOCC_PLANE_SHELF)
      ENCPGCC  ENSCHED  ENFORE  ENMAINT  ENBKG  ENIDLE
0          2          20       12        58       2        106

```

The percentage of ENET CPU occupancy related to idler-related processes for the transfer period is $(106/2) = 53\%$. The ENET CPU for this example is on plane 0, shelf 0.

Register ENIDLE release history

Register ENIDLE was introduced in BCS31.

Associated registers

There are no associated registers.

Associated logs

There are no associated logs.

Register ENMAINT

Maintenance occupancy (ENMAINT)

Register ENMAINT records if the ENET CPU performs maintenance-related processes.

At the beginning of the transfer period, the system sets the ENMAINT to zero. The system transfers ENET CPU maintenance occupancy value from the ENET node to the CM node every 60 s. The OM system samples maintenance occupancy value stored on the CM every 100 s. The slow sample period is 100 s. The OM system accumulates samples over the transfer period.

To obtain the percentage of ENET CPU occupancy attributed to maintenance-related processes, perform the following calculation. Divide the ENMAINT register value by the number of slow samples from the transfer period.

If a sample dump of OM group ENETOCC appears as follows:

OM group ENETOCC (continued)

```
CLASS:ACTIVE START:1996/04/24 17:30:00WED; STOP:1996/04/24 17:33:01WED;
SLOWSAMPLES:      2 ; FASTSAMPLES:      18 ;

INFO (ENETOCC_PLANE_SHELF)

      ENCPOCC   ENSCHED   ENFORE   ENMAINT   ENBKG   ENIDLE
0           0         0
      2         20        12         58        2        106
```

The percentage of ENET CPU occupancy related to maintenance-related processes for the transfer period is $(58/2) = 29\%$. The ENET CPU for this example is on plane 0, shelf 0.

Register ENMAINT release history

Register ENMAINT was introduced in BCS31.

Associated registers

There are no associated registers.

Associated logs

There are no associated logs.

Register ENSCHED

Scheduler occupancy (ENSCHED)

Register ENSCHED records if the ENET CPU performs scheduler-related processes.

At the beginning of the transfer period, the system sets ENSCHED to zero. The system transfers ENET CPU scheduler occupancy value from the ENET node to the CM node every 60 s. The OM system samples scheduler occupancy value stored on the CM every 100 s and accumulates the samples over the transfer period.

To obtain the percentage of ENET CPU occupancy related to scheduler-related processes, perform the following calculation. Divide the ENSCHED register value by the number of slow samples from the transfer period.

If a sample dump of OM group ENETOCC appears as follows:

OM group ENETOCC (end)

```

CLASS:ACTIVE START:1996/04/24 17:30:00WED; STOP:1996/04/24 17:33:01WED;
SLOWSAMPLES:      2 ; FASTSAMPLES:      18 ;
INFO (ENETOCC_PLANE_SHELF)
      ENCPOCC  ENSCHED  ENFORE  ENMAINT  ENBKG  ENIDLE
0
      2        20      12      58      2      106

```

The percentage of ENET CPU occupancy related to scheduler-related processes for the transfer period is $(20/2) = 10\%$. The ENET CPU for this example is on plane 0, shelf 0.

Register ENSCHED release history

Register ENSCHED was introduced in BCS31.

Associated registers

There are no associated registers.

Associated logs

There are no associated logs.

OM group ENETPLNK

OM description

Enhanced network (ENET) peripheral side (P-side) links (ENETPLINK)

All SuperNode offices with ENET have OM group ENETPLNK.

The OM group ENETPLNK monitors the performance of ENET P-side links. The OM group ENETPLNK contains seven peg registers that count the following events:

- errors on speech connections through the network
- errors on in-service links between the network and peripheral modules (PM)
- faults on P-side links
- ENET partitioning that occurs because an ENET P-side link is system busy
- ENET partitioning that occurs because an ENET P-side link is manual busy
- PMs that the system isolates because an ENET P-side link is system busy
- PMs that the system isolates because an ENET P-side link is manual busy

The OM group ENETPLNK also contains use registers that record the following events:

- A P-side link is system busy.
- A P-side link is manual busy.
- ENET partitioning occurs because an ENET P-side link is out of service.
- the system isolates a PM because an ENET P-side link is out of service.

Release history

The OM group ENETPLNK was introduced in BCS31.

BCS34

The system sets register ENLKPARU to zero.

Registers

The OM group ENETPLNK registers appear on the MAP terminal as follows:

OM group ENETPLNK (continued)

ENSPCHER	ENLKERR	ENLKFLT	ENSBLKU
ENMBLKU	ENLKPARU	ENSLKPAR	ENMLKPAR
ENLKISOU	ENSLKISO	ENMLKISO	

Group structure

The OM group ENETPLNK provides one tuple for each office.

Key field:

There is no Key field

Info field:

There is no Info field.

Associated OM groups

The OM groups ENETSYS monitors the performance of the ENET system cards.

The OM groups ENETMAT monitors the performance of the ENET matrix cards.

The OM groups ENETOCC provides information on the central processing unit occupancy of each in-service ENET. The OM group ENETOCC provides information on each ENET a DMS-100 Family switch.

Associated functional groups

The functional group SuperNode offices equipped with ENET associates with OM group ENETPLNK.

Associated functionality codes

The associated functionality codes for the OM group ENETPLNK appear in the following table.

Functionality	Code
ENET - Basic	NTXE01AA

OM group ENETPLNK (continued)

OM group ENETPLNK registers: P-side link errors

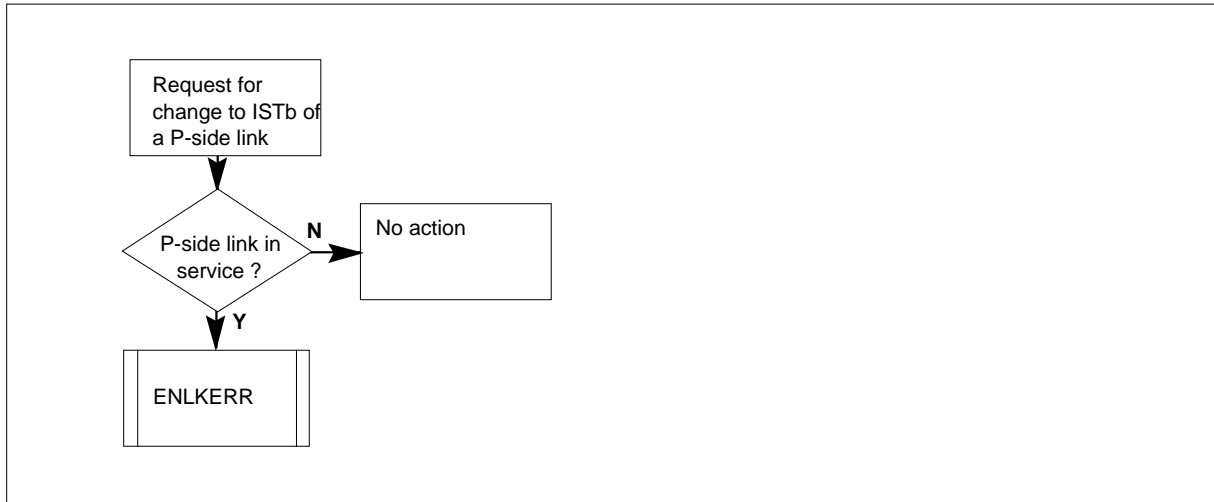

OM group ENETPLNK registers: P-side link faults

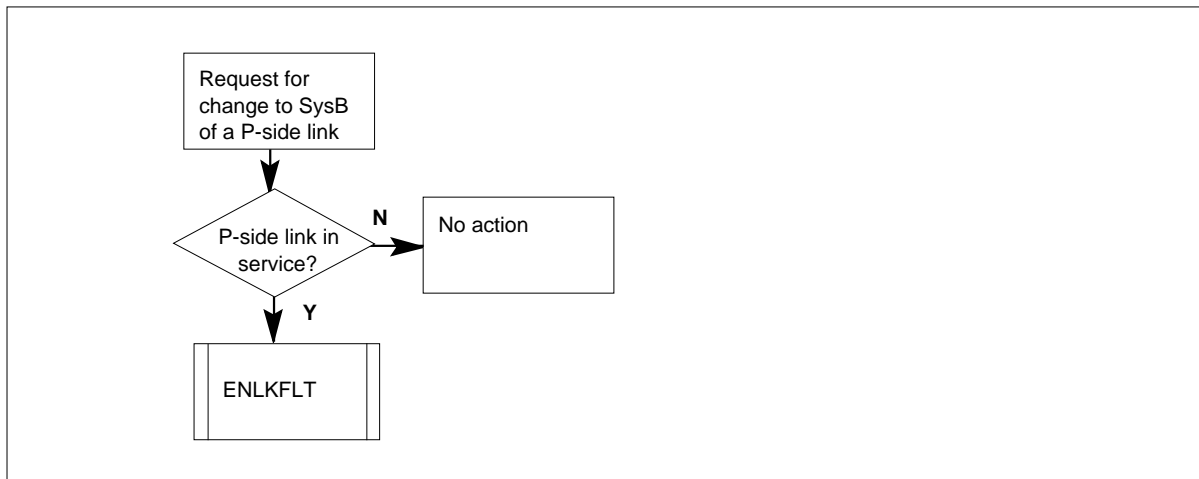

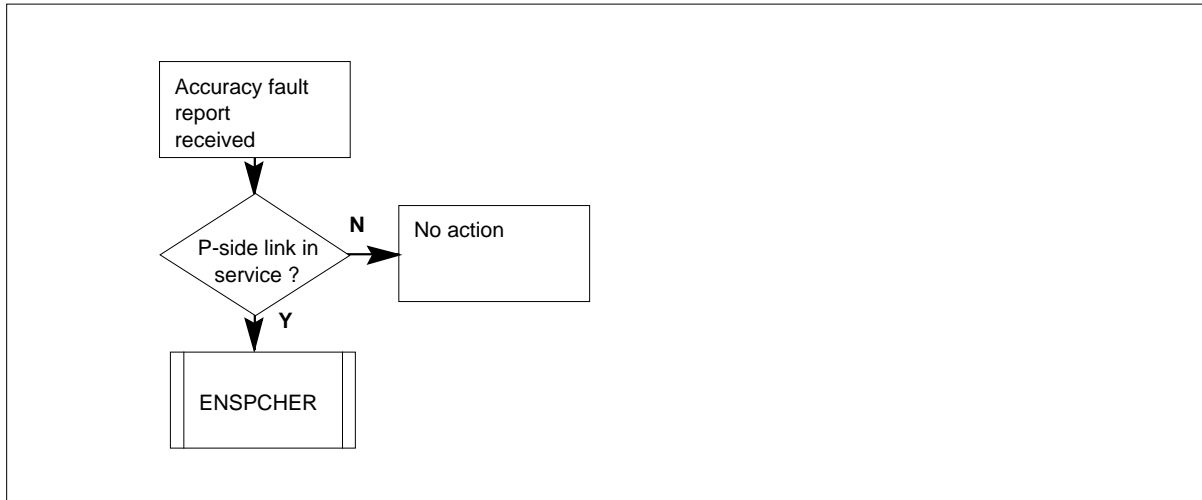
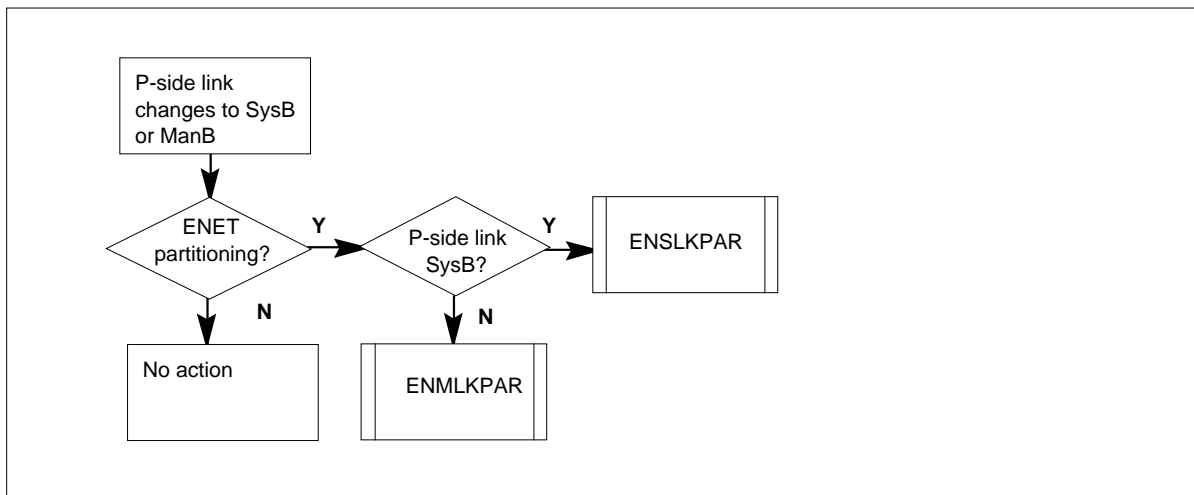
OM group ENETPLNK (continued)**OM group ENETPLNK registers: speech connection errors****OM group ENETPLNK registers: P-side link partitioning**

OM group ENETPLNK (continued)

OM group ENETPLNK registers: PM isolated

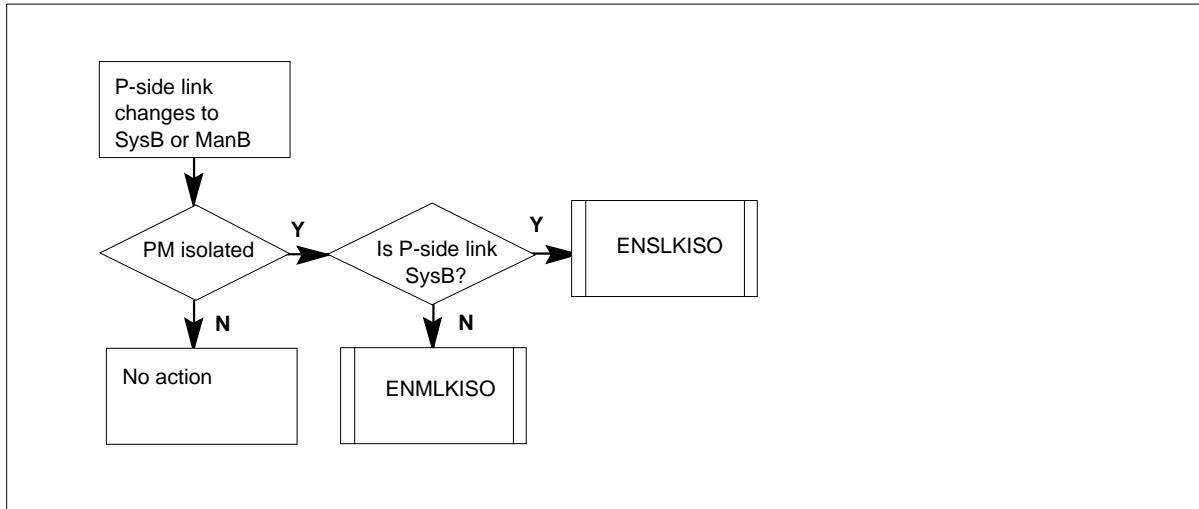

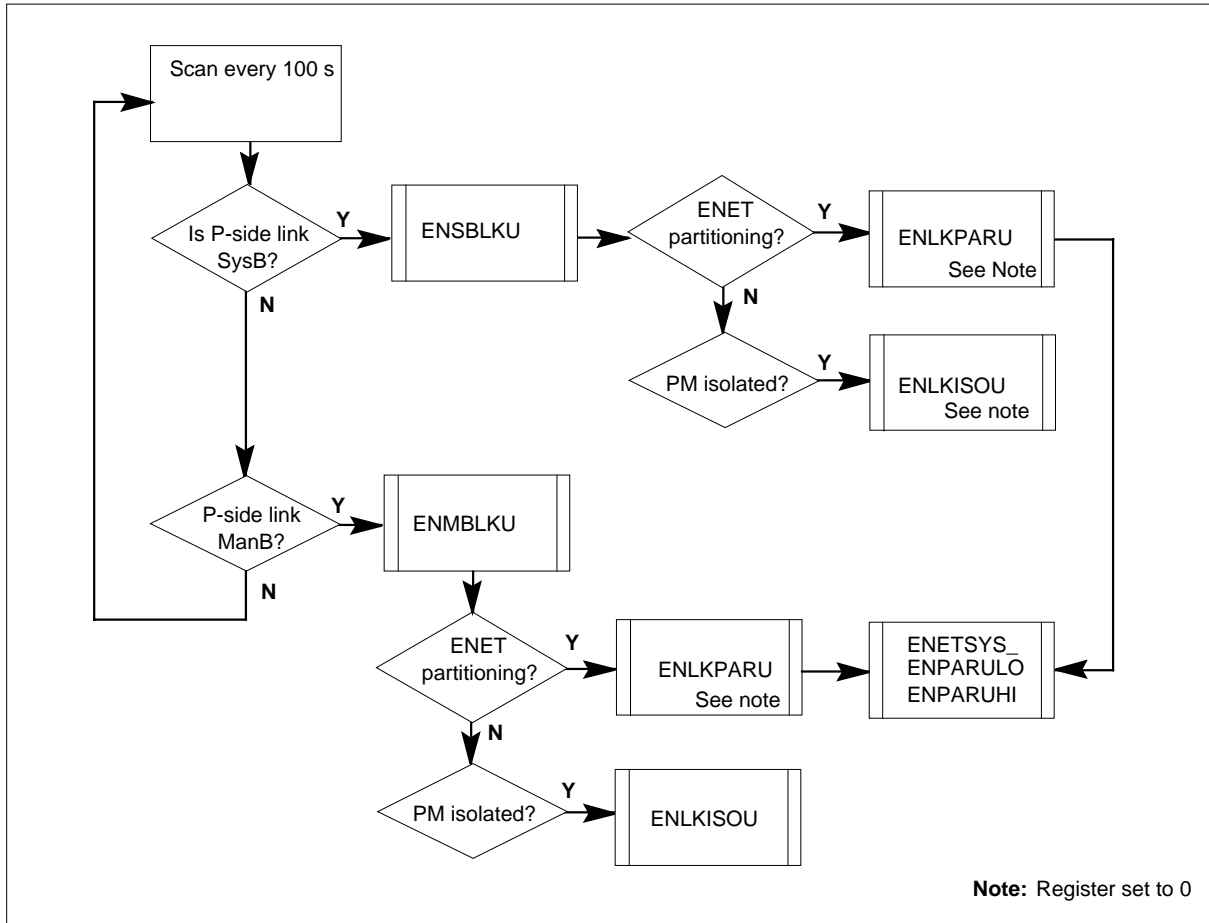
OM group ENETPLNK (continued)**OM group ENETPLNK registers: P-side link use registers****Register ENLKERR**

P-side link errors (ENLKERR)

Register ENLKERR counts all errors that the system detect on in-service links between the network and PMs.

Register ENLKERR release history

Register ENLKERR was introduced in BCS31.

Associated registers

There are no associated registers.

Associated logs

The system generates ENET308 when a P-side link is set to in-service trouble.

OM group ENETPLNK (continued)

Register ENLKFLT

P-side link faults (ENLKFLT)

Register ENLKFLT counts the number of times the system cannot recover a P-side link between the ENET and a PM. The recovery attempt occurs following detection of an error. The link is system busy until manual action or a successful system-initiated recovery attempt.

Register ENLKFLT release history

Register ENLKFLT was introduced in BCS31.

Associated registers

There are no associated registers.

Associated logs

The system generates ENET303 when a P-side link changes state from in service to system busy.

Register ENLKISOU

P-side link isolation use (ENLKISOU)

Register ENLKISOU is a use register. The system scans the ENET P-side links every 100 s. Register ENLKISOU records if the system isolated a PM because of an out-of-service link.

An isolated PM does not have access to the network. Isolation occurs when the last ENET P-side link that connects a PM to the rest of the network goes out of service. The PM becomes central side (C-side) busy.

A P-side link and the mate P-side link on the opposite plane are out of service. The ENLKISOU increases by the number of C-side busy PMs that these P-side links connect to the network. This condition must persist for 100 s before the register increases.

Register ENLKISOU release history

Register ENLKISOU was introduced in BCS31.

Associated registers

There are no associated registers.

Associated logs

There are no associated logs.

OM group ENETPLNK (continued)

Register ENLKPARU

P-side link partitioning usage (ENLKPARU)

Register ENLKPARU is a usage register. The system scans the ENET P-side links every 100 s. Register ENLKPARU records when: and . This condition must persist for 100 s for the register to increase.

- a minimum of one out-of-service link is present on plane 0
- a minimum of one out-of-service ENET components is present on plane 1

A 100 s interval must occur between these events for register ENLKPARU to increase.

This condition can partition the network. When partitioning occurs, ENLKPARU increases by number of paths the system cannot access from out-of-service P-side links.

Register ENLKPARU release history

Register ENLKPARU was introduced in BCS31.

BCS34

Register ENLKPARU is set to zero. Registers ENETSYS_ENPARUHI and ENETSYS_ENPARULO replace the ENLKPARU .

Associated registers

There are no associated registers.

Associated logs

There are no associated logs.

Register ENMBLKU

P-side link system busy usage (ENMBLKU)

Register ENMBLKU is a usage register. The system scans the ENET P-side links every 100 s. Register ENMBLKU records if a link is a system-busy link.

Register ENMBLKU release history

Register ENMBLKU was introduced in BCS31.

Associated registers

There are no associated registers.

Associated logs

There are no associated logs.

OM group ENETPLNK (continued)

Register ENMLKISO

P-side link manual busy isolation (ENMLKISO)

Register ENMLKISO counts in-service ENET P-side links that become manual busy and cause isolation of a minimum of one PM.

An isolated Pm does not access the network. Isolation occurs when the last ENET P-side link that connects the PM to the rest of the network goes out of service. The PM becomes C-side busy.

Register ENMLKISO release history

Register ENMLKISO is a usage register.

Associated registers

There are no associated registers.

Associated logs

The system generates ENET301 when a P-side link changes state from in service to manual busy.

Register ENMLKPAR

P-side link manual busy partitioning (ENMLKPAR)

Register ENMLKPAR when in-service ENET P-side links become ManB while links on the opposite plane are out of service. This condition blocks calls between PMs. This condition must continue for 100 s before register ENMLKPAR increases.

Register ENMLKPAR release history

Register ENMLKPAR was introduced in BCS31

Associated registers

There are no associated registers.

Associated logs

The system generates ENET301 when a P-side link changes state from in service to manual busy.

Register ENSBLKU

P-side link system busy use (ENSBLKU)

Register ENSBLKU is a usage register. The system scans the ENET P-side links every 100 s. Register ENSBLKU records if a link is system busy.

OM group ENETPLNK (continued)

Register ENSBLKU release history

Register ENSBLKU was introduced in BCS31

Associated registers

There are no associated registers.

Associated logs

There are no associated logs.

Register ENSLKISO

P-side link system busy isolation (ENSLKISO)

Register ENSLKISO counts in-service ENET P-side links that become system busy and cause isolation of a minimum of one PM.

An isolated PM does not have access to the network. Isolation occurs if the last ENET P-side link that connects a PM to the network goes out of service. The PM becomes C-side busy.

Register ENSLKISO release history

Register ENSLKISO was introduced in BCS31

Associated registers

There are no associated registers.

Associated logs

The system generates ENET301 when a P-side link changes state from in service to system busy.

Register ENSLKPAR

P-side link system busy partitioning (ENSLKPAR)

Register ENSLKPAR counts when in-service ENET P-side links become SysB. The links become SysB while P-side links on the opposite plane are out of service. This condition blocks calls between PMs. This condition must continue for 100 s before the register increases because of the scanning interval.

Register ENSLKPAR release history

Register ENSLKPAR was introduced in BCS31.

Associated registers

There are no associated registers.

OM group ENETPLNK (end)

Associated logs

The system generates the ENET303 when a P-side link changes state from in service to system busy.

Register ENSPCHER

P-side links speech errors (ENSPCHER)

Register ENSPCHER counts all errors detected on speech connections through the network.

The value in register ENSPCHER equals the number of integrity failure reports received from PM controllers. The following failures can cause an integrity failure:

- a failure of the PM at the other end of the connection
- a failure on a link between a PM and the network

Register ENSPCHER release history

Register ENSPCHER was introduced in BCS31.

Associated registers

There are no associated registers.

Associated logs

The system generates ENCP100 when the PM reports an integrity fault and does not terminate the connection. .

The system generates ENCP101 when a PM reports an accuracy mismatch for a terminated connection. The termination occurs when the fault handler begins to analyse the report.

The system generates ENCP102 when the PM reports an integrity failure and does not terminate the connection.

OM group ENETSYS

OM description

Enhanced network system card (ENETSYS)

All SuperNode offices with ENET have OM group ENETSYS

The OM group ENETSYS monitors the performance of the following enhanced network (ENET) system cards:

- NT9X13 - Processor card
- NT9X26 - Remote terminal interface paddle board
- NT9X36 - Network clock and message controller card
- NT9X40 - Quad DS-512 fiber interface paddle board
- NT9X30 - +5 V power converter
- NT9X31 - -5 V power converter

The ENETSYS contains 12 registers that count:

- errors in ENET system cards
- faults in ENET system cards
- calls that the system denies because system cards are out of service (OOS)
- ENET central processing unit (CPU) traps
- ENET CPU software errors (SWERR)
- ENET CPU warm restarts
- ENET CPU cold restarts
- ENET CPU reload-restarts
- ENET partitioning that occurs because an ENET system card is system busy
- ENET partitioning that occurs because an ENET system card is manual busy
- peripheral modules (PM) isolated because an ENET system card is system busy
- PMs isolated because an ENET system card is manual busy

The OM group ENETSYS also contains four use registers that record when:

- a system card is system busy
- a system card is manual busy

OM group ENETSYS (continued)

- ENET partitioning occurs because an ENET system card is OOS
- a PM isolated because an ENET system card is OOS

Release history

The OM group ENETSYS was introduced in BCS31.

BCS34

The system sets ENPARU to zero. Registers ENPARUHI and ENPARULO replace the ENPARU.

Registers

The OM group ENETSYS registers appear on the MAP terminal as follows:

ENERR	ENFLT	ENSBU	ENMBU
ENCALDND	ENTRAPS	ENSWERRS	ENWARM
ENCOLD	ENRELOAD	ENPARU	ENSPARP
ENMPARP	ENISOU	ENSISOP	ENMISOP
ENPARUHI	ENPARULO		

Group structure

The OM group ENETSYS provides one tuple per office.

Key field:

There is no Key field

Info field:

There is no Info field

Associated OM groups

The OM group ENET peripheral side (P-side) MAT monitors the performance of the ENET matrix cards.

The OM group ENETPLNK monitors the performance of the ENET P-side links.

The OM group ENETOCC provides information about the CPU occupancy of each in-service ENET in a DMS-100 Family switch.

Associated functional groups

The functional group SuperNode offices with ENET associates with OM group ENETSYS.

OM group ENETSYS (continued)**Associated functionality codes**

The associated functionality codes for OM group ENETSYS appear in the following table.

Functionality	Code
ENET - Basic	NTXE01AA

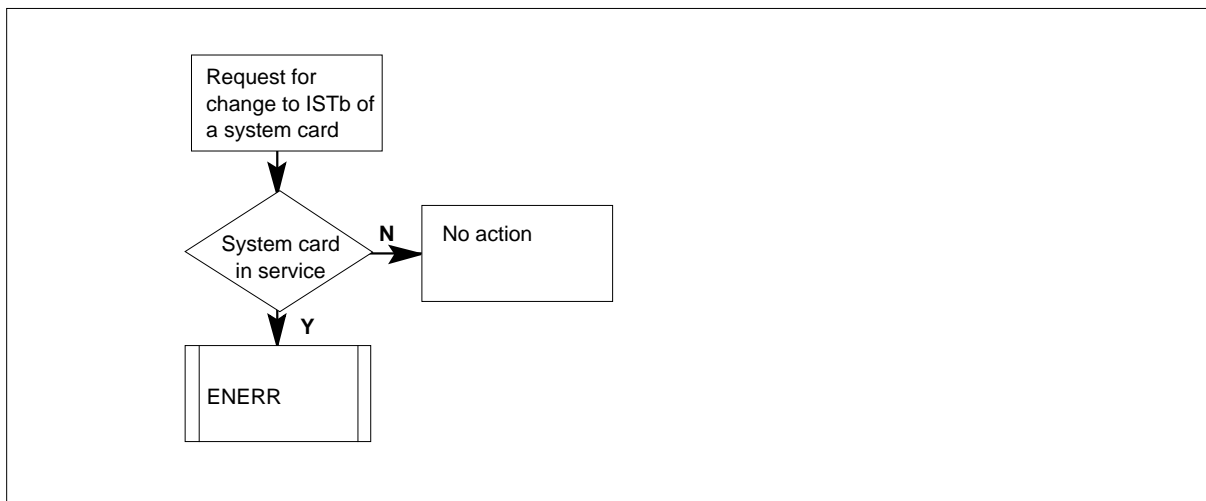
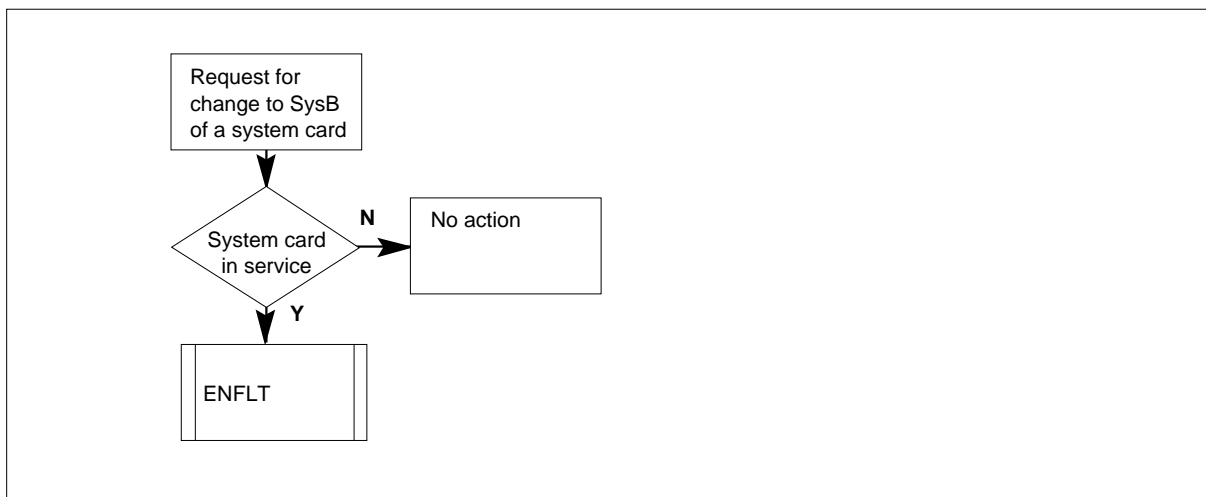
OM group ENETSYS registers: system card errors**OM group ENETSYS registers: system card faults**

OM group ENETSYS (continued)

OM group ENETSYS registers: calls denied

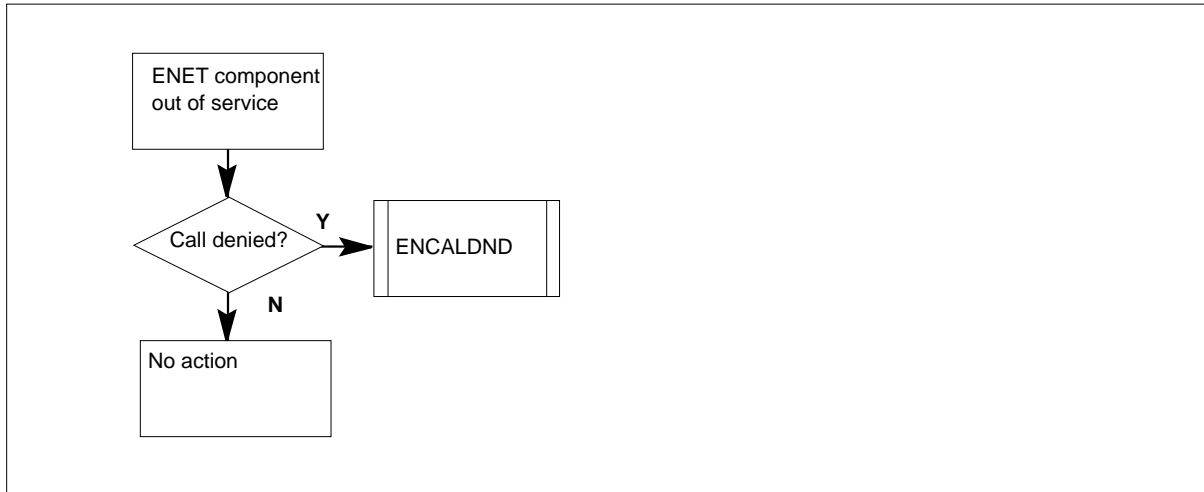

OM group ENETSYS registers: ENET partitioning

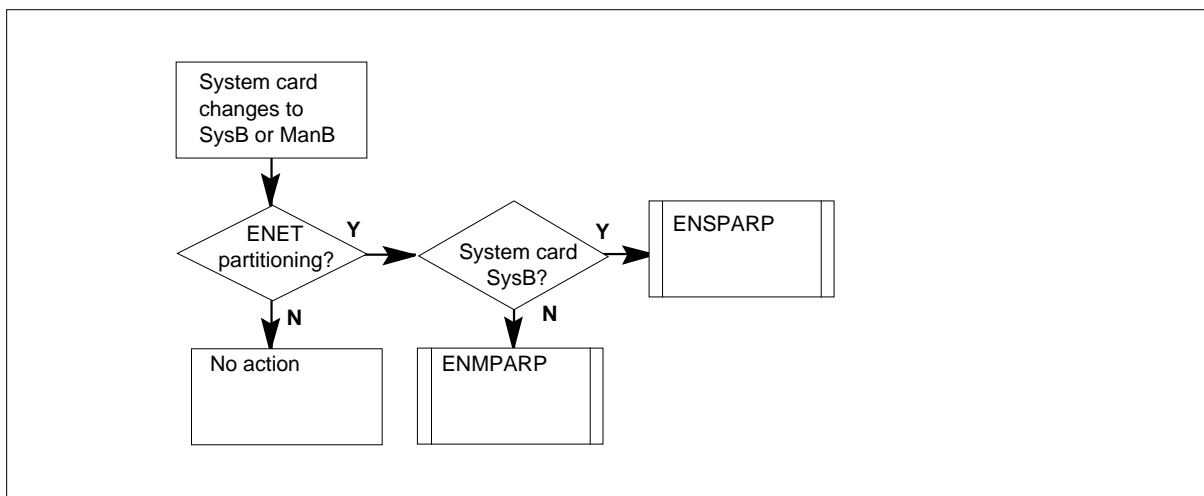

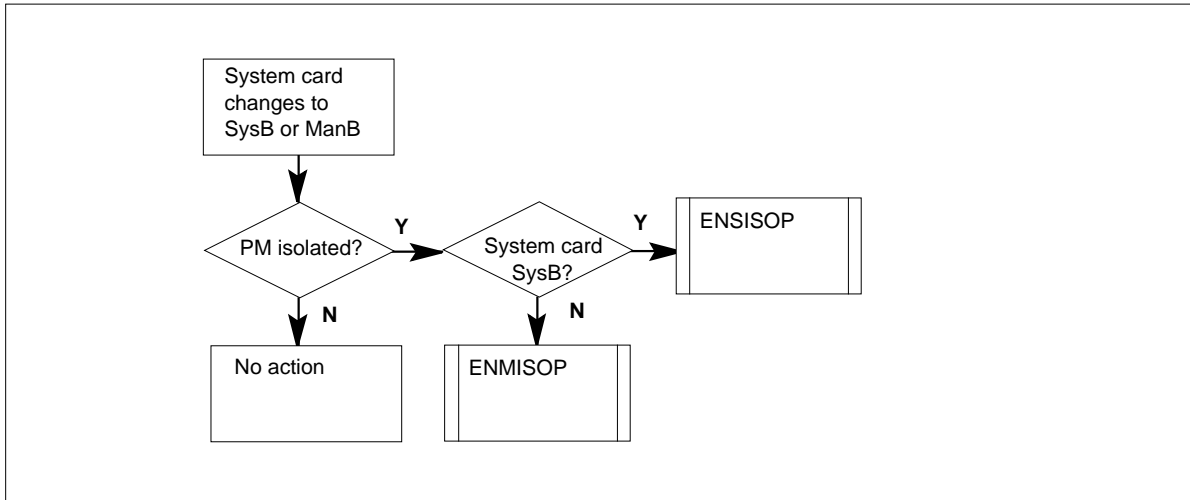
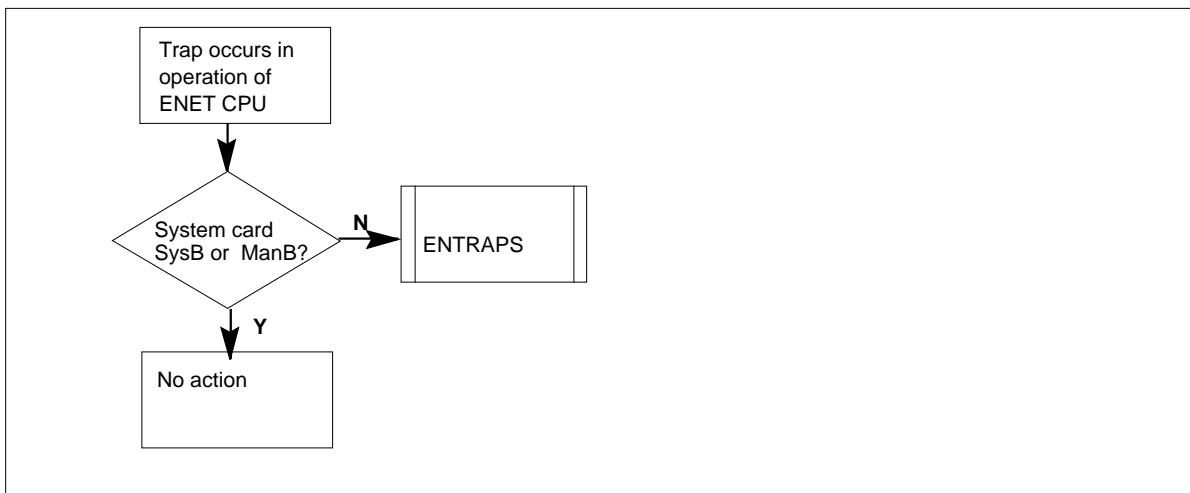
OM group ENETSYS (continued)**OM group ENETSYS registers: PM isolation****OM group ENETSYS registers: trap in operation of ENET CPU**

OM group ENETSYS (continued)

OM group ENETSYS registers: SWERR in operation of ENET CPU

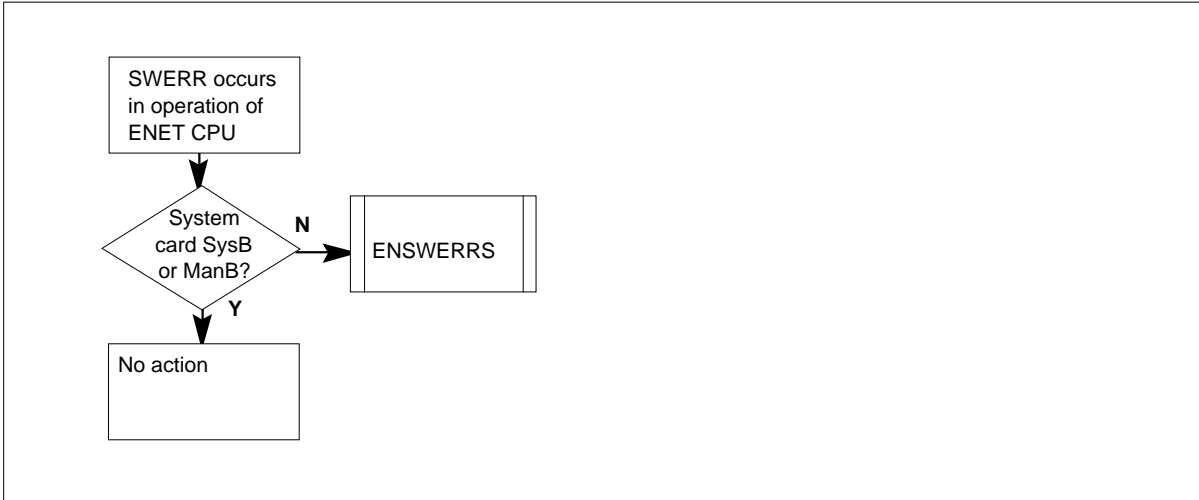

OM group ENETSYS registers: ENETSYS restarts

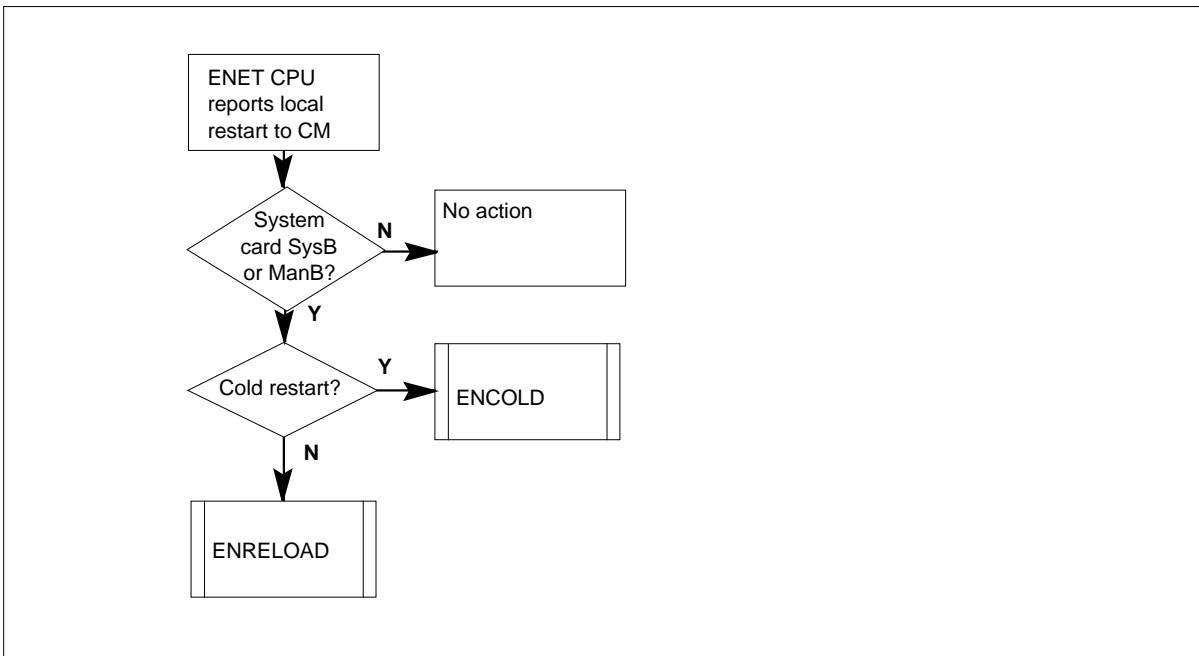

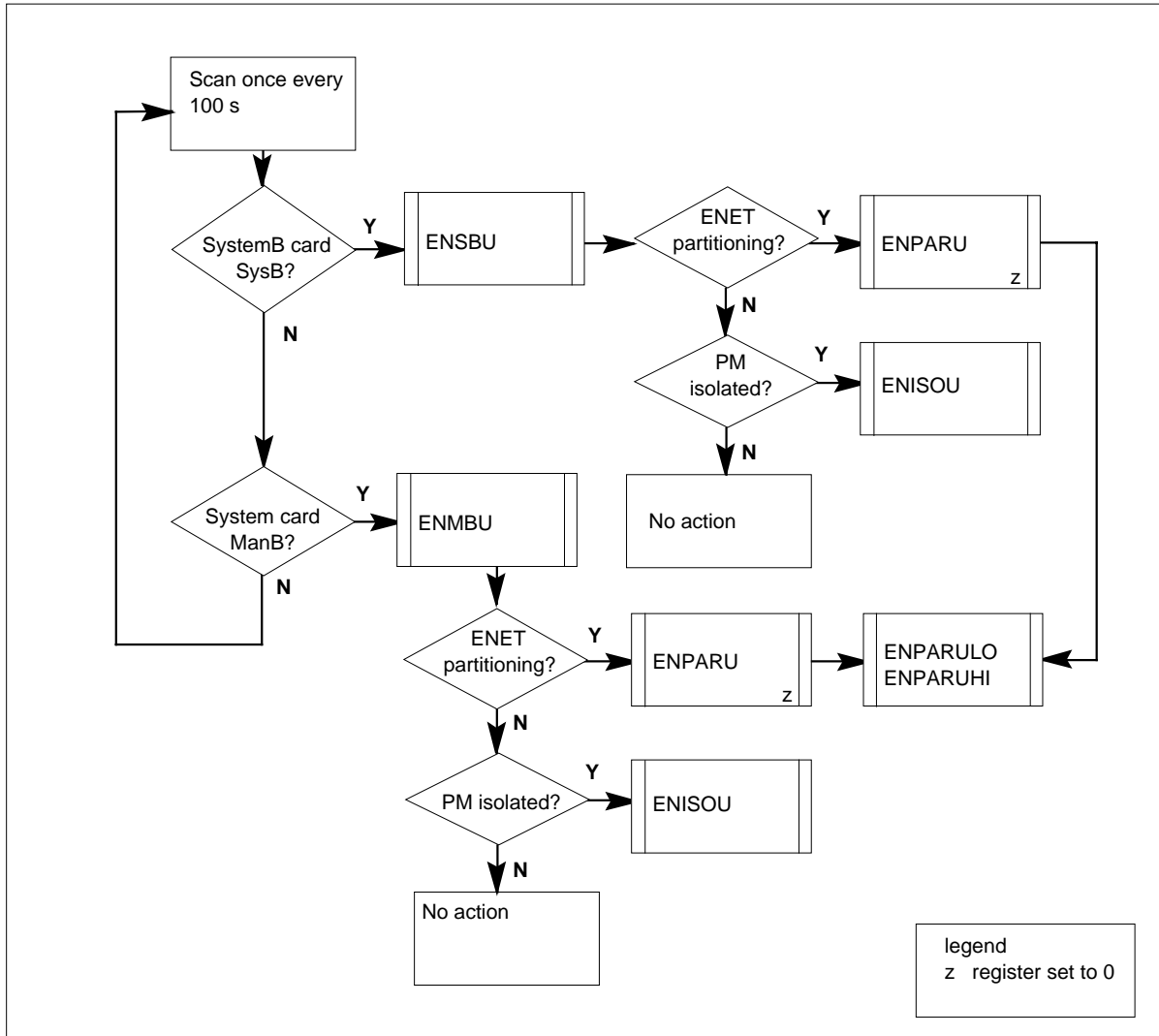
OM group ENETSYS (continued)**OM group ENETSYS registers: busy use registers****Register ENCALDND**

Calls denied (ENCALDND)

REGISTER ENCALDND counts calls that the system denies because ENET components in both planes are OOS. An OOS component is a component that is system busy, manual busy, central side (C-side) busy, or off line.

Register ENCALDND release history

Register ENCALDND was introduced in BCS31.

OM group ENETSYS (continued)

Associated registers

There are no associated registers.

Associated logs

The system generates ENCP136 when an attempt to establish an ENET connection. The system generates the log when the hardware needed for connection is OOS in both planes.

Register ENCOLD

Cold restarts (ENCOLD)

Register ENCOLD counts cold restarts that occur in the operation of the ENET CPU.

Register ENCOLD release history

Register ENCOLD was introduced in BCS31.

Associated registers

There are no associated registers.

Associated logs

The system generates ENET103 when an ENET node changes state from in service to system busy.

Register ENERR

System card errors (ENERR)

Register ENERR counts errors that the system detects in the operation of the ENET system cards. This count includes errors that the system detects:

- through problem reports from the ENET local processor
- as a result of routine or initializing audits
- through the failure of an ENET shelf to respond to the computing module

Register ENERR release history

Register ENERR was introduced in BCS31.

Associated registers

There are no associated registers.

Associated logs

The system generates ENET108 when the system sets an ENET node to in-service trouble.

OM group ENETSYS (continued)

Register ENFLT

System card faults (ENFLT)

Register ENFLT counts the number of times an ENET system card cannot recover from an error. The ENET is system busy until manual action or a successful system recovery.

Register ENFLT release history

Register ENFLT was introduced in BCS31.

Associated registers

There are no associated registers.

Associated logs

The system generates ENET103 when an ENET node changes state from in service to system busy.

Register ENISOU

System card isolation usage (ENISOU)

Register ENISOU is a usage register. Register ENISOU records peripheral modules (PM) because of OSS ENET system cards every 100 s.

An isolated PM does not have access to the network. Isolation occurs if the last ENET system card that connects a PM to the rest of the network becomes OOS. The PM becomes central-side busy.

If a system card and its mate on the opposite plane are OOS, register ENISOU increases. Register ENISOU increases by the number of C-side busy PMs that the system cards connect to the network.

Register ENISOU release history

Register ENISOU was introduced in BCS31.

Associated registers

There are no associated registers.

Associated logs

There are no associated logs.

Register ENMBU

System card manual busy usage (ENMBU)

OM group ENETSYS (continued)

The ENMBU is a usage register. Register ENMBU records ENET system cards that are manual busy every 100 s.

Register ENMBU release history

Register ENMBU was introduced in BCS31.

Associated registers

There are no associated registers.

Associated logs

There are no associated logs.

Register ENMISOP

Manual busy isolation with system cards (ENMISOP)

Register ENMISOP counts in-service ENET system cards that become manual busy and cause isolation of a minimum of one PM.

An isolated PM does not have access to the network. Isolation occurs if the last ENET system card that connects a PM to the network goes out of service. The PM becomes central-side busy.

Register ENMISOP release history

Register ENMISOP was introduced in BCS31.

Associated registers

There are no associated registers.

Associated logs

The system generates ENET101 when an ENET node changes state from in service to manual busy.

Register ENMPARP

System card manual busy partitioning (ENMPARP)

Register ENMPARP counts in-service ENET system cards that become manual busy when a system card on opposite plane is OOS. This condition can partition the network and block calls. A 100 s interval must occur between these events for this register ENMPARP to increase.

Register ENMPARP release history

The ENMPARP was introduced in BCS31.

OM group ENETSYS (continued)

Associated registers

There are no associated registers.

Associated logs

The ENET101 generates when an ENET node changes state from in service to manual busy.

Register ENPARU

Partitioning use with system cards (ENPARU)

Register ENPARU is a usage register. Register ENPARU records when: if an OOS ENET system card exists on plane zero. ENPARU also records if an OOS ENET component exists on plane 1. A 100-s interval must occur between these events for this register to increase.

- a minimum of one out-of-service link is present on plane 0
- a minimum of one out-of-service ENET component is present on plane 1

A 100 s interval must occur between these events for register ENPARU to increase.

This condition can partition the network. When partitioning occurs, register ENPARU increases by the number of paths the system cannot access. These parts are from the P-side links off the OOS ENET system card to other P-side links.

Register ENPARU release history

Register ENPARU was introduced in BCS31.

BCS34

The system sets register ENPARU to zero. Registers ENPARUHI and ENPARULO replace register ENPARU.

Associated registers

There are no associated registers.

Associated logs

There are no associated logs.

Register ENPARUHI

ENET partitioning usage register high (ENPARUHI)

Register ENPARUHI is a usage register that works with register ENPARULO. These registers show how many paths are not available for call processing.

OM group ENETSYS (continued)

The paths are not available because of out-of-service hardware components in either plane.

A scan rate occurs every 100 s. Register ENPARUHI increases when the ENPARULO exceeds 65535.

Total partitioning = (ENPARUHI x 65535) + ENPARULO

Register ENPARUHI and register ENPARULO replace the usage registers ENPARU, ENETMAT_ENCDPARU, ENETMAT_ENPBPAPU, and ENETPLNK_ENLKPARU. The old registers were plane-dependent and did not give a clear view of the whole network.

Register ENPARUHI release history

Register ENPARUHI was introduced in BCS34.

Associated registers

There are no associated registers.

Associated logs

There are no associated logs.

Extension registers

Register ENPARULO

Register ENPARULO

ENET partitioning use register low (ENPARULO)

Register ENPARULO is a usage register that works together with register ENPARUHI. These registers reflect the number of paths not available for call processing. The paths are not available because of out-of-service hardware components in either plane.

A scan rate occurs every 100 s. After ENPARULO exceeds 65535, it is reset and ENPARUHI increases by one.

Total partitioning = (ENPARUHI x 65535) + ENPARULO

Register ENPARULO and register ENPARUHI replace the usage registers ENPARU, ENETMAT_ENCDPARU, ENETMAT_ENPBPAPU, and ENETPLNK_ENLKPARU. The old registers were plane-dependent and did not give a clear view of the whole network.

OM group ENETSYS (continued)

Register ENPARULO release history

Register ENPARULO was introduced in BCS34.

Associated registers

There are no associated registers.

Associated logs

There are no associated logs.

Extension registers

Register ENPARUHI

Register ENRELOAD

Reload restarts (ENRELOAD)

Register ENRELOAD counts reload restarts that occur in the operation of the ENET CPU.

Register ENRELOAD release history

Register ENRELOAD was introduced in BCS31.

Associated registers

There are no associated registers.

Associated logs

The system generates ENET103 when an ENET node changes state from in service to system busy.

Register ENSBU

System card system busy usage (ENSBU)

Register ENSBU is a usage register. Register ENSBU records when an ENET system card is system busy every 100 s.

Register ENSBU release history

Register ENSBU was introduced in BCS31.

Associated registers

There are no associated registers.

Associated logs

There are no associated logs.

OM group ENETSYS (continued)

Register ENSISOP

System busy isolation (ENISISOP)

Register ENSISOP counts in-service ENET system cards that become system busy and cause isolation of a PM.

An isolated PM does not have access to the network. Isolation occurs if the last ENET system card connecting a PM to the network becomes OOS. The PM becomes central-side busy.

Register ENSISOP release history

Register ENSISOP was introduced in BCS31.

Associated registers

There are no associated registers.

Associated logs

The system generates ENET103 when an ENET node changes state from in service to system busy.

Register ENSPARP

System busy partitioning (ENSPARP)

Register ENSPARP counts when an in-service ENET system card becomes system busy while an ENET component on opposite plane is OOS. A 100 s interval must occur between these events for the register to increase. This condition can partition the network and block calls.

Register ENSPARP release history

Register ENSPARP was introduced in BCS31.

Associated registers

There are no associated registers.

Associated logs

The system generates ENET103 when an ENET node changes state from in service to system busy.

Register ENSWERRS

Enhanced network (ENET) software error (SWERRS) (ENSWERRS)

Register ENSWERRS counts SWERRS that occur in the operation of the ENET system card.

OM group ENETSYS (end)

Register ENSWERRS release history

Register ENSWERRS was introduced in BCS31.

Associated registers

There are no associated registers.

Associated logs

The system generates SWERSS when:

- a software condition affects normal operation of the DMS or DMS PMs
- the LOGUTIL utility of a MAP display requests a log trace

Register ENTRAPS

Enhanced network (ENET) traps (ENTRAPS)

Register ENTRAPS counts traps that occur in the operation of the ENET system cards.

Register ENTRAPS release history

Register ENTRAPS was introduced in BCS31.

Associated registers

There are no associated registers.

Associated logs

The system generates TRAP when a software or hardware error condition causes an interruption of normal DMS operation.

Register ENWARM

Warm restarts (ENWARM)

Register ENWARM is not active.

Register ENWARM release history

Register ENWARM was introduced in BCS31.

Associated registers

There are no associated registers.

Associated logs

There are no associated logs.

OM group ESUP

OM description

Digital echo suppressor (ESUP)

The OM group ESUP provides information on digital echo suppressor (DES) circuits. Each DES card contains eight circuits that provide echo suppression for eight separate channels. The DES circuits monitor the levels of digital speech signals on the transmit and receive paths between connected trunk circuits. DES circuits automatically apply attenuation when necessary, to reduce echo effects on long-distance trunk circuits.

Two peg registers count requests for a DES. Three usage registers record when DES circuits are in maintenance states.

The OM group ESUP data helps to assess the performance of DES cards, and to make sure that the configuration meets traffic requirements.

Release history

The OM group ESUP was introduced before BCS20.

Registers

The OM group ESUP registers appear on the MAP terminal as follows:

DESSZRS	DESOVFL	DESTRU	DESSBU	DESMBU
---------	---------	--------	--------	--------

Group structure

The OM group ESUP provides one tuple for each key.

Key field:

CP_SELECTOR is the external identifier ESUP.

Info field:

DES_OM_INFO is the number of DES circuits that the software defines.

Associated OM groups

There are no associated OM groups.

Associated functional groups

The following functional groups associate with OM group ESUP:

- DMS-100 Local
- DMS-100/200 Local/Toll

OM group ESUP (continued)

- DMS-200 Toll
- DMS-250 Toll/Tandem
- DMS-300 Gateway
- DMS International
- DMS-MTX

Associated functionality codes

The associated functionality codes for the OM group ESUP appear in the following table.

Functionality	Code
Echo Suppressor	NTX063AA

OM group ESUP (continued)

OM group ESUP registers

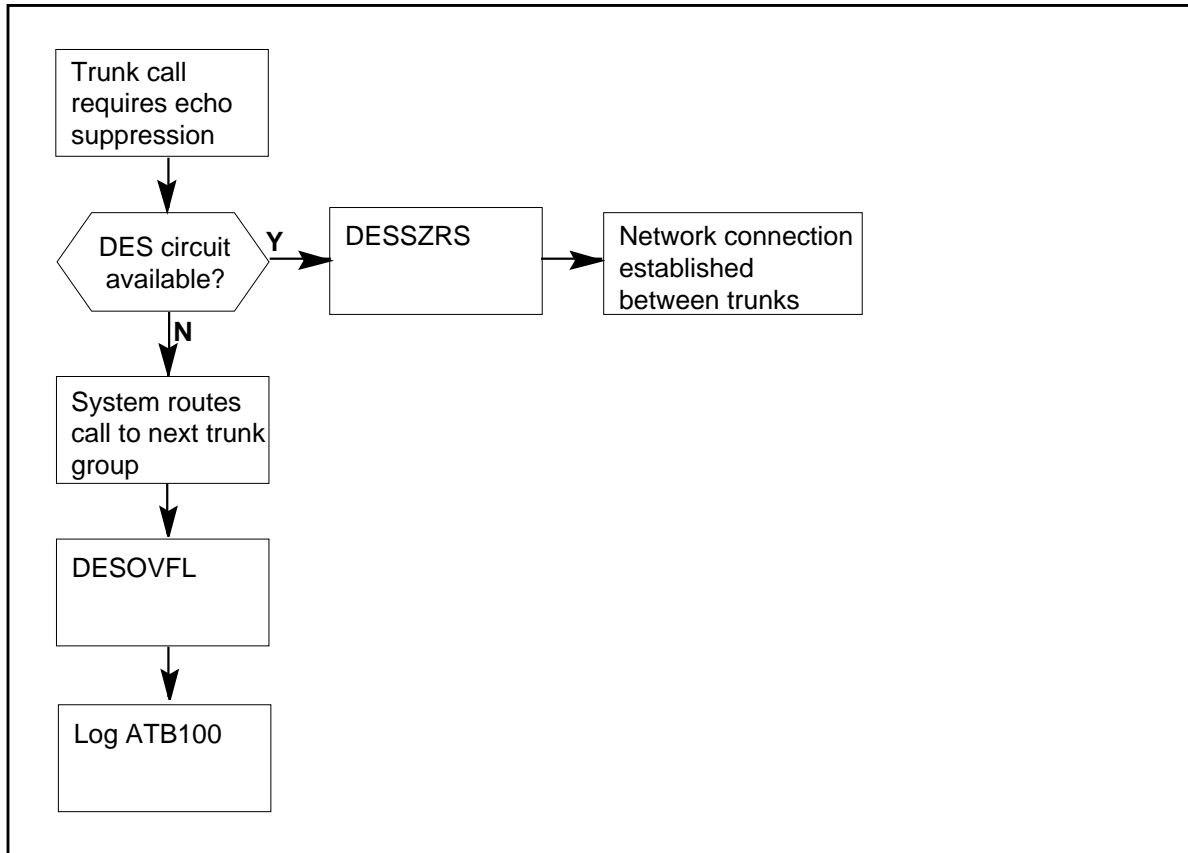

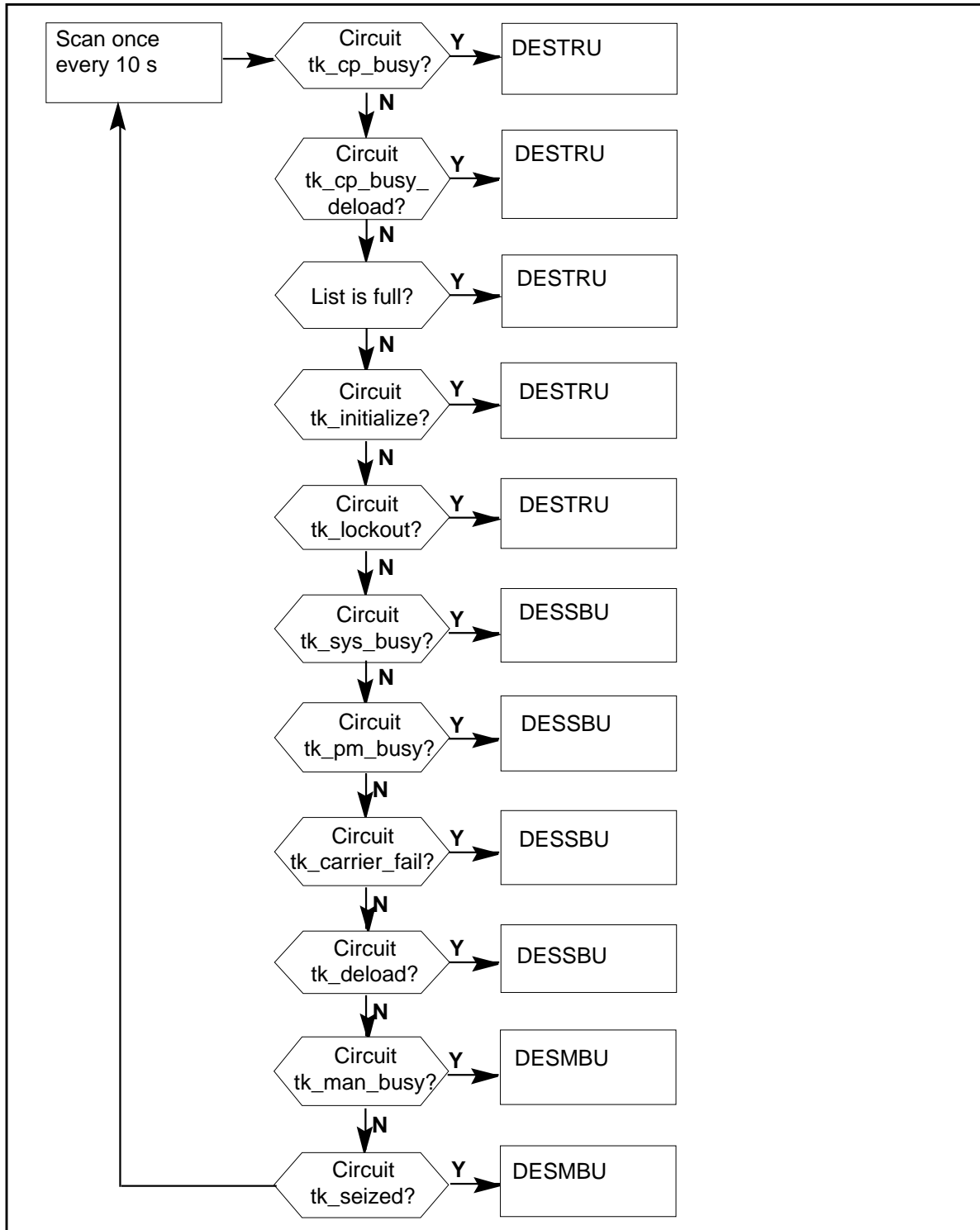
OM group ESUP (continued)**OM group ESUP use registers**

OM group ESUP (continued)

Register DESMBU

Digital echo suppressor manual busy use (DESMBU)

Register DESMBU is a usage register. The scan rate is 10 s. Register DESMBU records when digital echo suppressor circuits are manual busy or seized.

Register DESMBU release history

Register DESMBU was introduced before BCS20.

Associated registers

There are no associated registers.

Associated logs

There are no associated logs.

Extension registers

There are no extension registers.

Register DESOVFL

Digital echo suppressor overflow (DESOVFL)

Register DESOVFL increases when a request for a digital echo suppressor (DES) fails because idle circuits are not available.

When a request for a DES fails, the system routes the call to the next trunk group in the routing list. The system searches for a route that does not require a DES.

Register DESOVFL release history

Register DESOVFL was introduced before BCS20.

Associated registers

There are no associated registers.

Associated logs

The system generates ATB100 if trunks are not available to route incoming calls. The system routes the calls to a specific numbering plan area or switching office.

Extension registers

There are no extension registers.

OM group ESUP (continued)

Register DESSBU

Digital echo suppressor system busy use (DESSBU)

Register DESSBU is a usage register. The scan rate is 10 s. The DESSBU records when digital echo suppressor circuits are in the following states:

- system busy
- peripheral module busy
- carrier fail
- deloaded

Register DESSBU release history

Register DESSBU was introduced before BCS20.

Associated registers

There are no associated registers.

Associated logs

The system generates PM105 when a peripheral module becomes manual busy.

The system generates PM109 when when a T1 carrier becomes system busy.

The system generates PM182 when the P-side link of a peripheral module becomes manual busy.

The system generates TRK106 when a diagnostic on trunk equipment fails.

The system generates TRK109 when a diagnostic performed on a DS-1 facility fails.

Extension registers

There are no extension registers.

Register DESSZRS

Digital echo suppressor seizure (DESSZRS)

Register DESSZRS increases when a request for a digital echo suppressor (DES) is successful and a DES circuit handles a call.

Register DESSZRS increases before the network connects the DES circuit and the trunks.

OM group ESUP (end)

Register DESSZRS release history

Register DESSZRS was introduced before BCS20.

Associated registers

There are no associated registers.

Associated logs

There are no associated logs.

Extension registers

There are no extension registers.

Register DESTRU

Digital echo suppressor trunk use (DESTRU)

Register DESTRU is a usage register. The scan rate is 10 s. Register DESTRU records when digital echo suppressor circuits are in the following states:

- call processing busy
- call processing busy deload
- initialize
- lockout

Register DESSZRS release history

Register DESSZRS was introduced before BCS20.

Associated registers

There are no associated registers.

Associated logs

There are no associated logs.

Extension registers

There are no extension registers.

OM group EXNDINV

OM description

External node inventory (EXNDINV)

The OM group EXNDINV provides information about the availability and performance of external nodes. The OM group EXNDINV also provides information about maintenance level activity on nodes entered in table EXNDINV. This OM group adds the external node type OSNM to the range of correct keys. The system transmits messages between the Digital Multiplex System (DMS) switch application and a remote service peripheral module (SPM). The advanced services protocol (ASP) allows this transmission. This OM group counts messages and failures to deliver messages because of problems with the remote node, hardware, or the ASP. Two usage registers record how long the external node is system busy or manual busy.

Release history

The OM group EXNDINV was introduced in BCS35.

NA006

External node type OSNM was introduced in NA006 as a correct EXNDINV key.

Registers

The OM group EXNDINV registers appear on the MAP terminal as follows:

OM group EXNDINV (continued)

```

OMSHOW EXNDINV ACTIVE

EXNDINV

CLASS:    ACTIVE
START:1995/06/14 00:30:00 WED; STOP: 1995/06/14 00:44:51 WED
SLOWSAMPLES:      9 ; FASTSAMPLES:      89 ;

      KEY (TENNAME_TYPE)
      INFO (EXNDINV_OMINFO)

          SYSBUSE      MANBUSE      INSSYSB      INSMANB
          LK1FAIL      RTSFAIL      TSTFAIL      PROTVIOL
          DLMTX        DLMRX        DLMSW        DLMER

0 BRTPHname
  OSNM 0
          0            0            0            0
          0            0            0            0
          0            0            0            0
    
```

Note: Operator Services System Advanced Intelligent Network (OSSAIN) does not support the following registers: DLMER, DLMRX, DLMSW, DLMTX, LK1FAIL, and PROTVIOL.

Group structure

The OM group EXNDINV provides 32 tuples for each office.

Key field:

TENNAME_TYPE (12 character string)
 (This key is the ENPMTYPE field of table EXDINV).

Info field:

EXNDINV_OMINFO (TENPM_TYPE [external nodename],
 TENNODENO [external node number])

Associated OM groups

The OM group OASNPOOL

OM group EXNDINV (continued)

Associated functional groups

The following functional groups associate with OM group EXNDINV:

- Intelligent Services Node (ISN)
- LAN-supported external nodes
- Nodes entered in table EXNDINV

NA006

Functional group ENSV Enhanced Services (ENSV0001) introduced external node type OSNM in NA006. External node type OSNM was introduced as a correct value in the range of correct keys of OM group EXNDINV. The introduction occurs through the Operator Services AIN (ENSV0014) functionality.

Associated functionality codes

The associated functionality codes for OM group EXNDINV appear in the following table.

Functionality	Code
ISN Basic	NTXR87AA
Operator Services AIN	ENSV0014 (NA006)

OM group EXNDINV (continued)

OM group EXNDINV registers: SPM maintenance

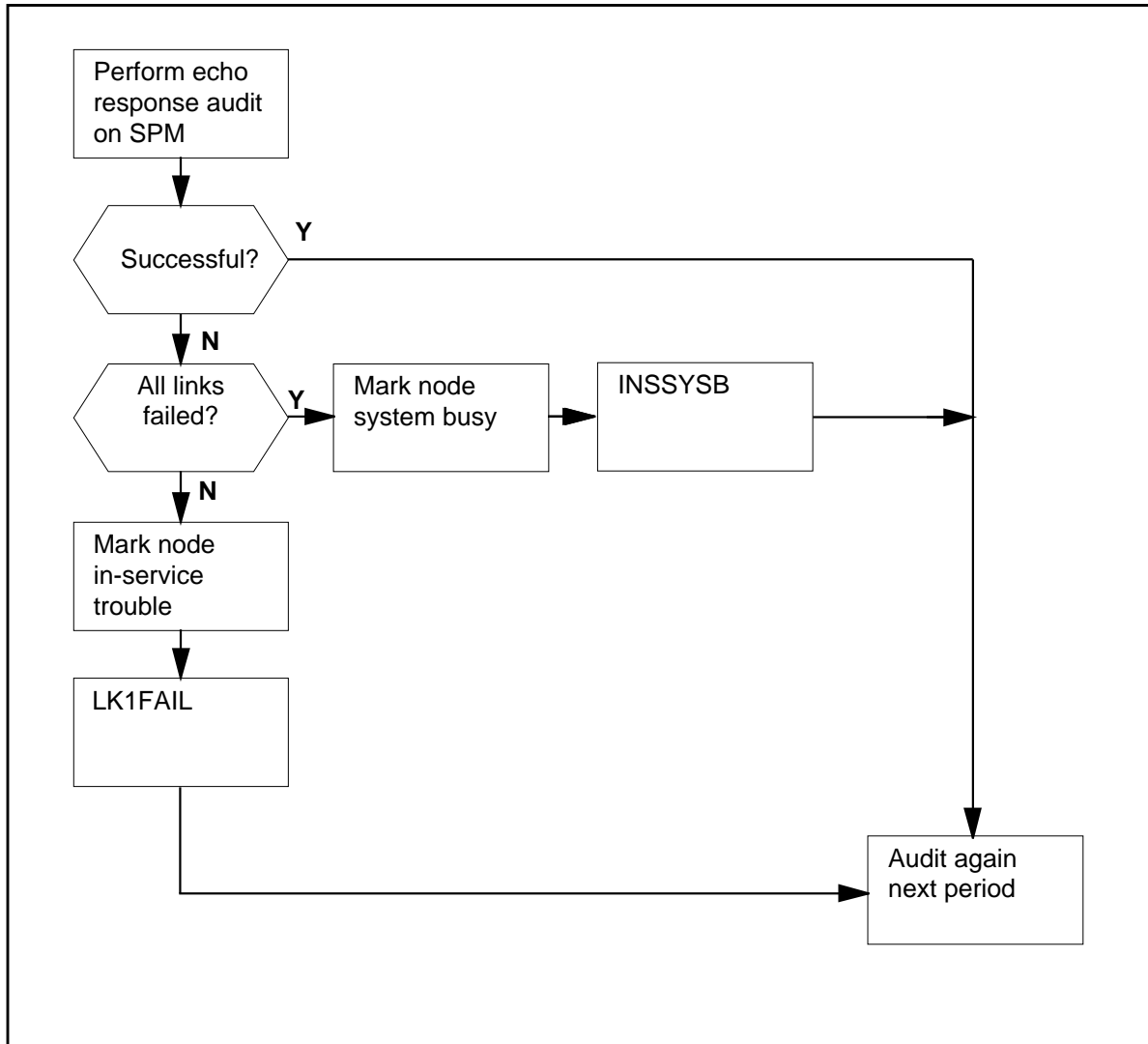

OM group EXNDINV (continued)

OM group EXNDINV registers: SPM maintenance (continued)

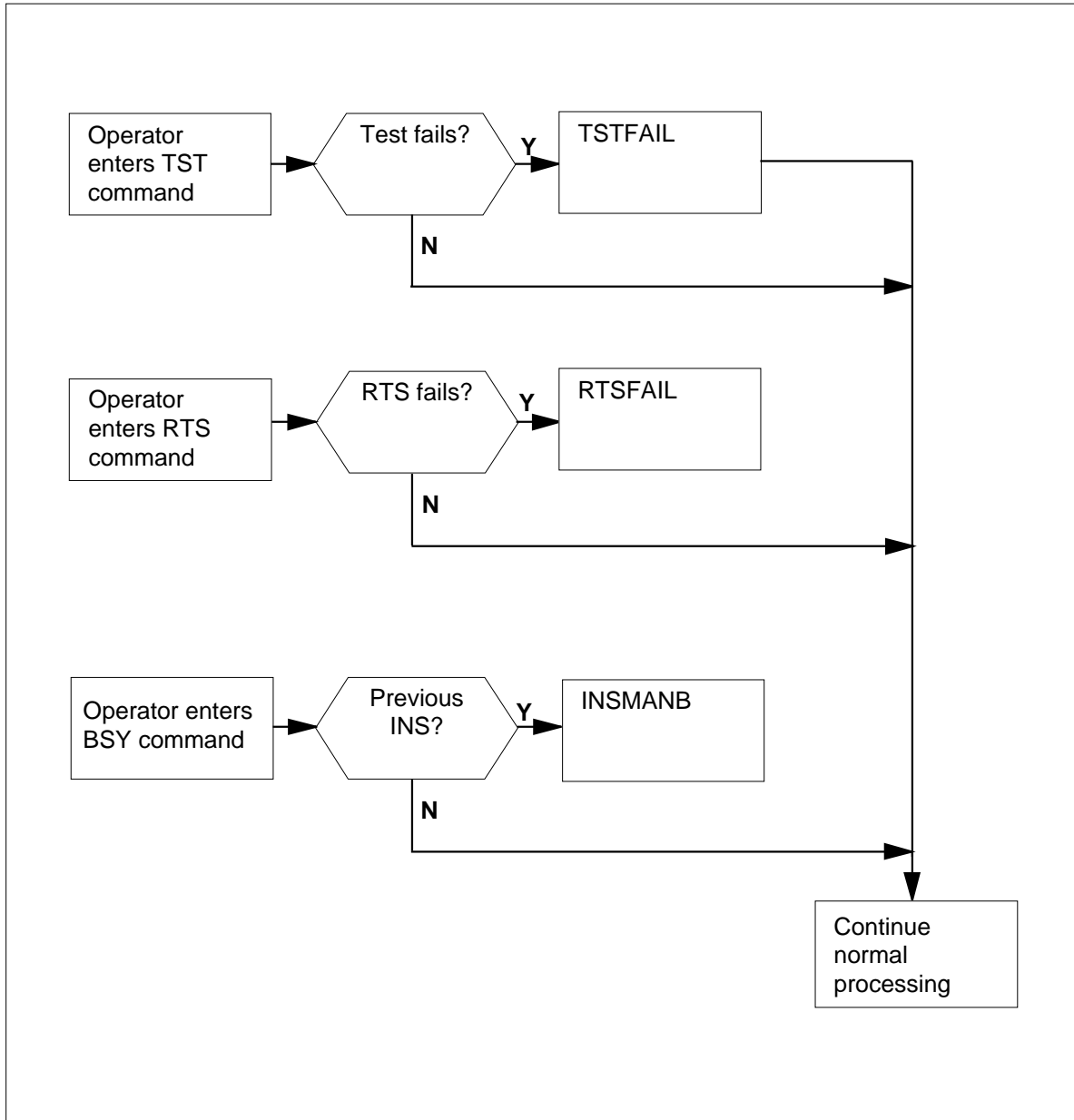

OM group EXNDINV (continued)

OM group EXNDINV registers: use registers

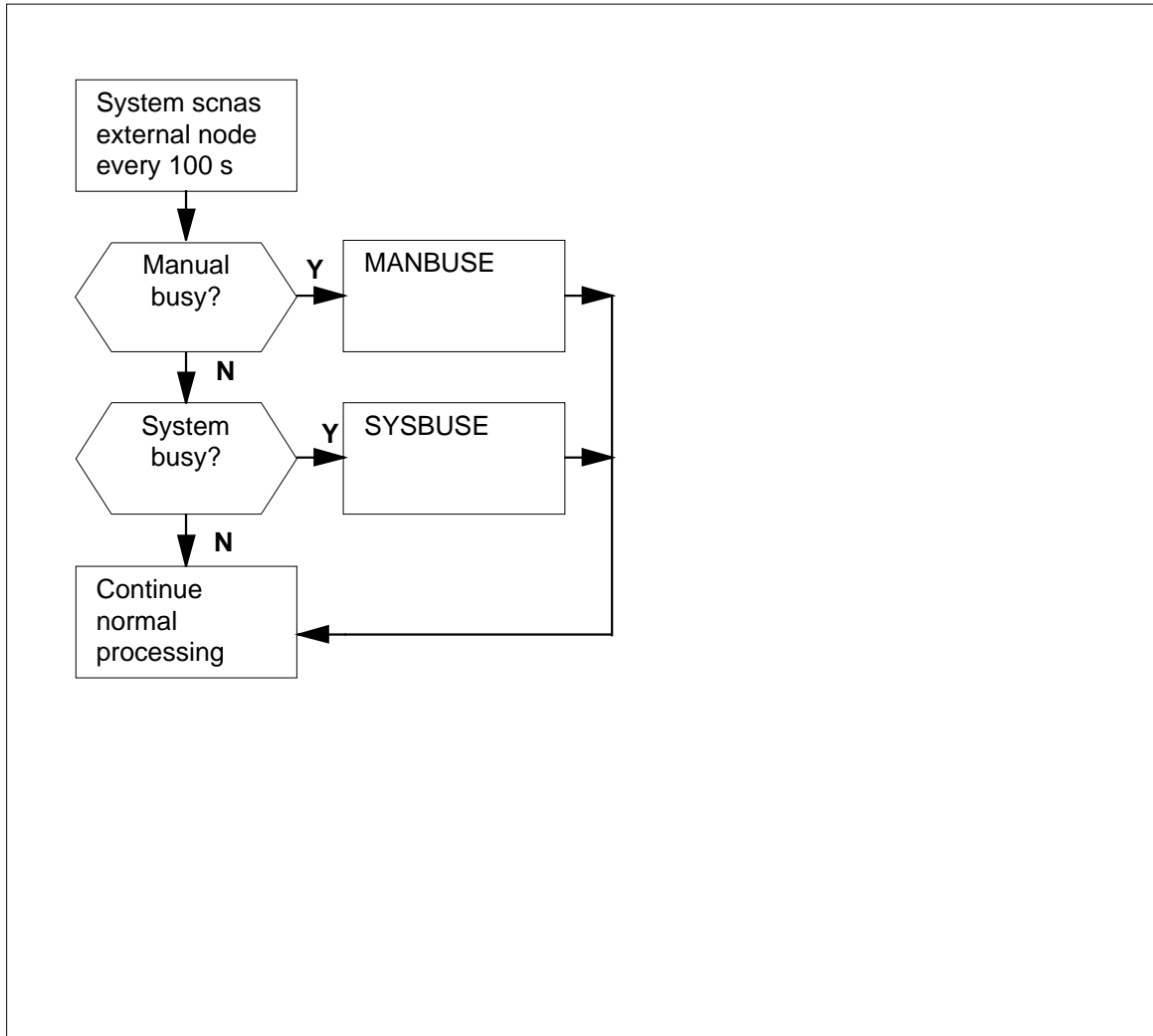

OM group EXNDINV (continued)

OM group EXNDINV registers: protocol violation

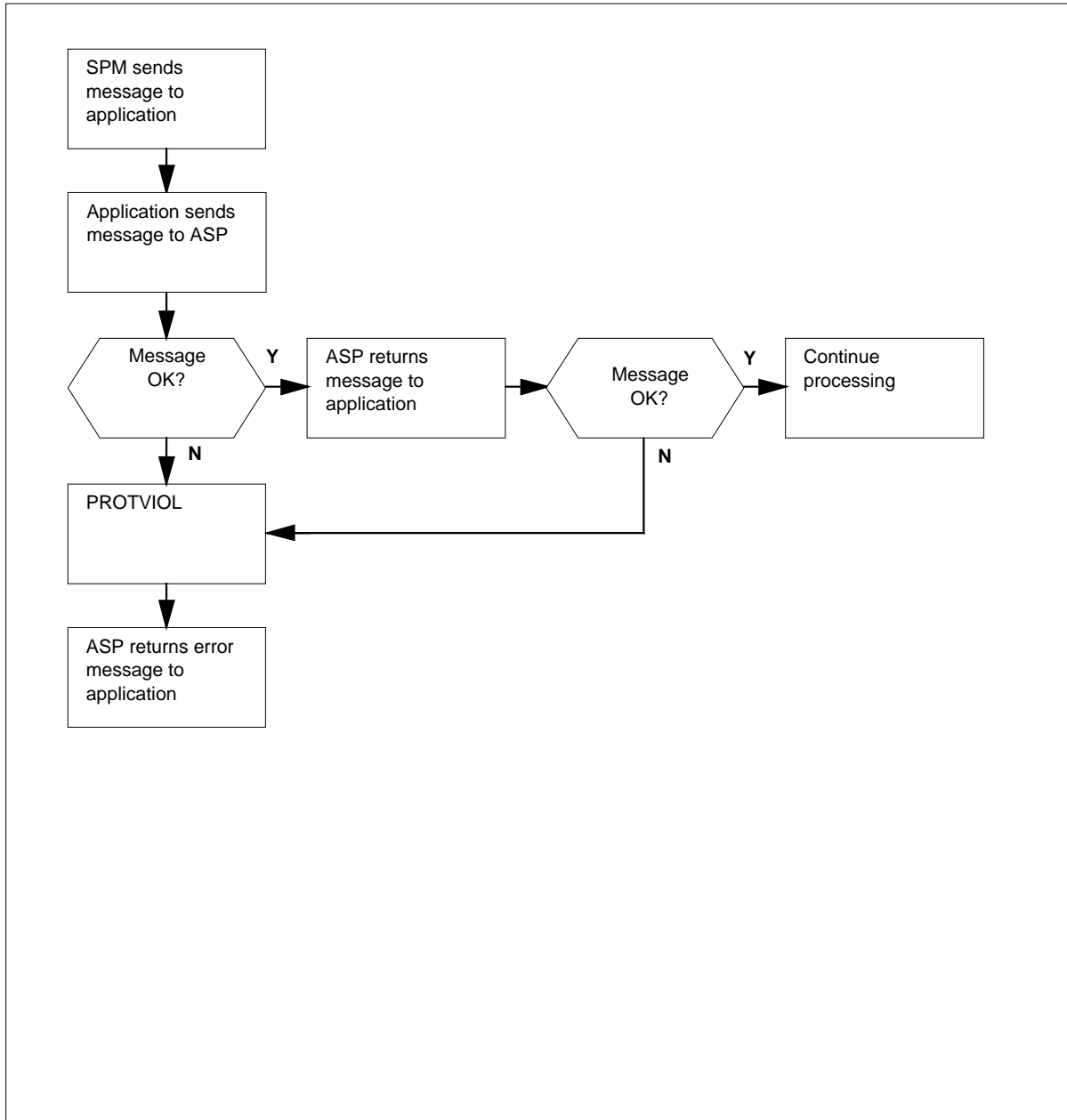

OM group EXNDINV (continued)

OM group EXNDINV registers: datalink manager

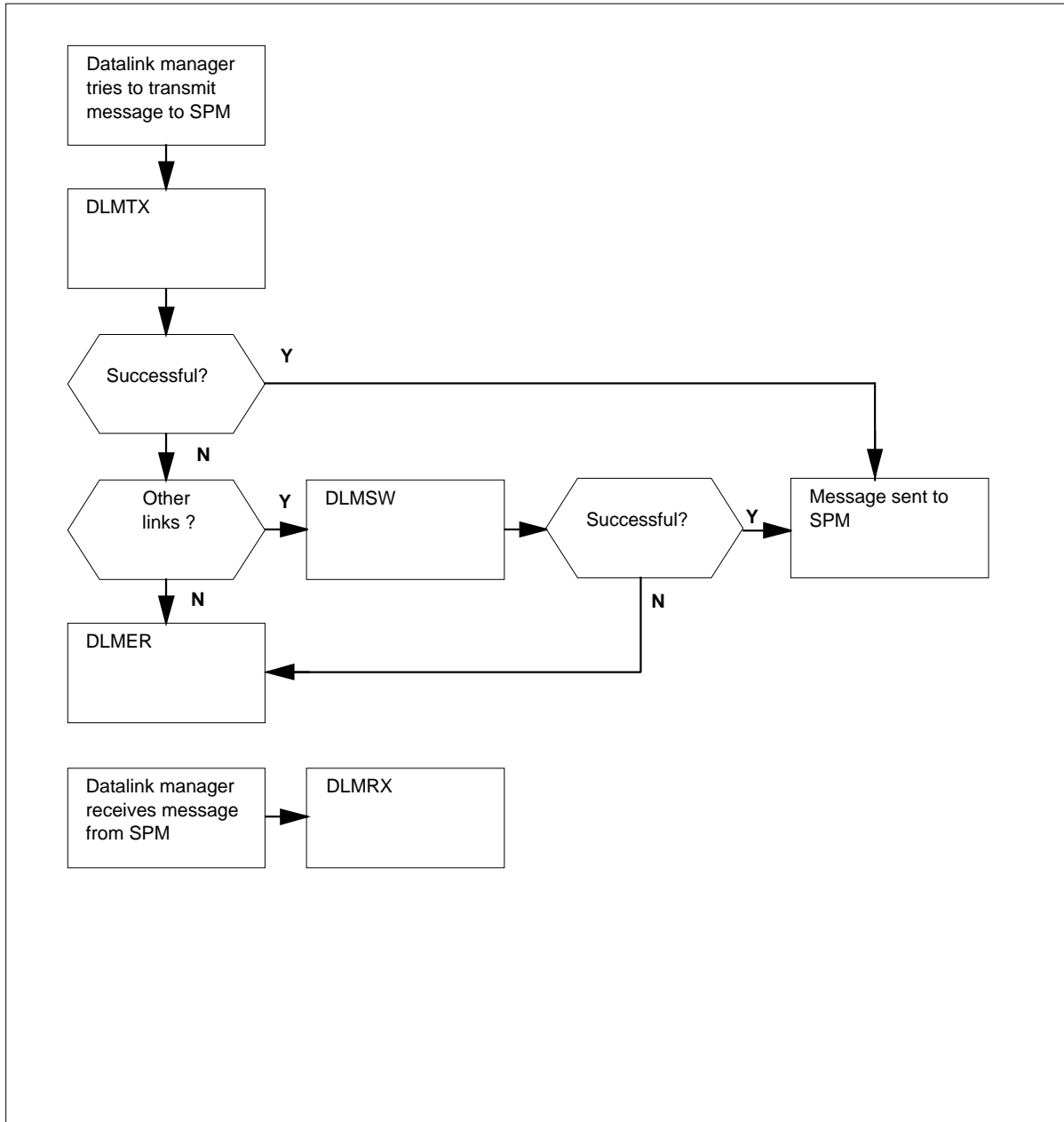

Register DLMER

Datalink manager errors (DLMER)

Register DLMER counts failed attempts to send a message to the SPM. This count includes output messages the datalink manager cannot deliver to the SPM because of remote, protocol, or hardware problems.

OM group EXNDINV (continued)

Note: The OSSAIN does not support this register.

Register DLMER release history

Register DLMER was introduced in BCS35.

Associated registers

Register DLMTX counts the number of times the datalink manager attempts to transmit a message to the SPM.

$DLMER \leq DLMTX$

Associated logs

There are no associated logs.

Extension registers

There are no extension registers.

Register DLMRX

Datalink manager received (DLMRX)

Register DLMRX counts the number of times the datalink manager receives an input message from the SPM. This event occurs when a call goes to a remote external node.

Note: The OSSAIN does not support this register.

Register DLMRX release history

Register DLMRX was introduced in BCS35.

Associated registers

There are no associated registers.

Associated logs

There are no associated logs.

Extension registers

There are no extension registers.

Register DLMSW

Datalink manager switched (DLMSW)

OM group EXNDINV (continued)

Register DLMSW counts each time the SPM must send a message across an alternate link. When the system tries multiple links, this register increases only once for each message sent.

The SPM must send a message across an alternate link when:

- a hardware failure occurs.
- an Ethernet interface unit (EIU) normally used for this data transmission is busy. The EIU becomes busy when several calls are in progress and the system must route some output messages over different links.

Note: The OSSAIN does not support this register.

Register DLMSW release history

Register DLMSW was introduced in BCS35.

Associated registers

Register DLMTX counts each time the datalink manager attempts to send a message to the SPM.

$DLMSW \leq DLMTX$

Associated logs

There are no associated logs.

Extension registers

There are no extension registers.

Register DLMTX

Datalink manager transmit (DLMTX)

Register DLMTX counts each time the datalink manager tries to send an output message to an SPM. A call to a remote external node increases this register.

Note: The OSSAIN does not support this register.

Register DLMTX release history

Register DLMTX was introduced in BCS35.

Associated registers

Register DLMSW counts each time the SPM must send a message across an alternate link. Register DLMER increases each time a link to the SPM is not successful.

OM group EXNDINV (continued)

DLMTX > = DLMSW

DLMTX > = DLMER

Associated logs

There are no associated logs.

Extension registers

There are no extension registers.

Register INSMANB

In service to manual busy (INSMANB)

Register INSMANB counts each time an external node changes state from the in-service to manual-busy. This event occurs when you issue the BSY command at the MAP terminal.

Register INSMANB release history

Register INSMANB was introduced in BCS35.

Associated registers

Register MANBUSE records the amount of time an external node is in the manual-busy state.

If MANBUSE > 0, INSMANB > 0.

Associated logs

The system generates PM105 each time INSMANB increases.

Extension registers

There are no extension registers.

Register INSSYSB

In service to system busy (INSSYSB)

Register INSSYSB counts each time an external node changes state from in-service to system-busy.

Register INSSYSB release history

Register INSSYSB was introduced in BCS35.

OM group EXNDINV (continued)

Associated registers

Register SYSBUSE records the amount of time an external node is system-busy.

If $SYSBUSE > 0$, then $INSSYSB > 0$.

Associated logs

The system generates PM102 when register INSSYSB increases.

Extension registers

There are no extension registers.

Register LK1FAIL

Link one fail (LK1FAIL)

Register LK1FAIL counts each time an external node fails the internet control message protocol (ICMP) echo message test on one of the two links.

Note: The OSSAIN does not support this register.

Register LKIFAIL release history

Register LKIFAIL was introduced in BCS35.

Associated registers

There are no associated registers.

Associated logs

The system generates PM128 when one of the links connected to the associated node fails the ICMP echo message test.

Extension registers

There are no extension registers.

Register MANBUSE

Manual busy usage (MANBUSE)

Register MANBUSE records the amount of time an external node is manual-busy every 100 s.

Register MANBUSE release history

Register MANBUSE was introduced in BCS35.

OM group EXNDINV (continued)

Associated registers

Register INSMANB counts each time an external node changes state from in-service to manual-busy.

If $\text{INSMANB} > 0$, MANBUSE must be > 0 . An exception occurs when the device becomes manual busy less than 100 s before the transfer from holding register to active register.

Associated logs

There are no associated logs.

Extension registers

There are no extension registers.

Register PROTVIOL

Protocol violation (PROTVIOL)

Register PROTVIOL counts each time advanced services protocol (ASP) or an application that uses ASP detects a high-level protocol violation.

Note: The OSSAIN does not support this register.

Register PROTVIOL release history

Register PROTVIOL was introduced in BCS35.

Associated registers

There are no associated registers.

Associated logs

The system generates ASP100 when an application that uses the ASP detects a protocol violation.

The system generates ASP101 when the ASP detects a protocol violation.

Extension registers

There are no extension registers.

Register RTSFAIL

Return-to-service failure (RTSFAIL)

Register RTSFAIL counts each time an external node fails to return to service after a manual request or switch maintenance actions.

OM group EXNDINV (continued)

Register RTSFAIL release history

Register RTSFAIL was introduced in BCS35.

Associated registers

There are no associated registers.

Associated logs

The system generates PM181 if an external node fails to return to service when requested from the MAP terminal.

For OSSAIN, the system generates PM100 if an external node fails to return to service. The system generates PM 100 after a return to service request at the MAP terminal.

Extension registers

There are no extension registers.

Register SYSBUSE

System busy usage (SYSBUSE)

Register SYSBUSE records the amount of time an external node is system-busy every 100 s.

Register SYSBUSE release history

Register SYSBUSE was introduced in BCS35.

Associated registers

Register INSSYSB counts each time an external node changes state from in-service to system-busy.

If INSSYSB is > 0 , SYSBUSE must be > 0 . An exception occurs if the device becomes system busy less than 100 s before transfer from holding register to active register.

Associated logs

There are no associated logs.

Extension registers

There are no extension registers.

Register TSTFAIL

Test failures (TSTFAIL)

OM group EXNDINV (end)

Register TSTFAIL counts each time the system does not receive the audit echo response from the SPM. Register TSTFAIL counts these reception failures when you issue the TST command at the MAP.

Register TSTFAIL release history

Register TSTFAIL was introduced in BCS35.

Associated registers

There are no associated registers.

Associated logs

The system generates PM181 when a test command fails.

Extension registers

There are no extension registers.

OM group EXT

OM description

This OM group monitors the use of extension blocks. Primarily, extension blocks serve as a storage mechanism to store feature data on a per-call basis. The group can be used to monitor

- the number of requests made for a particular type of extension block (EXTSEIZ)
- the maximum number of extension blocks of each type that are in simultaneous use during the preceding OM transfer period (EXTHI)
- the number of overflows when a particular type of extension block is not available (EXTOVFL)

In addition to serving as a storage mechanism, extension blocks also function as an auxiliary software resource allocated to calls for

- special billing records
- data extensions for operator services
- custom calling features

The data collected in EXT indicate the types of extension blocks that are used most often and indicate extension blocks that are underprovisioned or overprovisioned.

Release history

Release history follows:

UCS08

Added extension block tuple T_CAIN_EXT_BLOCK.

UCS07

Added extension block tuples CAIN_ECCBS_BLOCKS and CAIN_STR_EXT_BLOCK.

UCS06

Added extension block tuple CAIN_FRAMEWORK_EXT_BLOCK.

UCS05

Seven key field entries added: DMS250_BBF_EXT_BLK_FC, DMS250_FEATURE_EXT_FMT_CD, AUX_EXT_BLOCK, SMALL_EE_EXT_BLK_FC, MEDIUM_EE_EXT_BLK_FC, LARGE_EE_EXT_BLK_FC, and CAIN_EXT_BLOCK.

OM group EXT (continued)**Registers**

OM group EXT registers display on the MAP terminal as follows:

```

>omshow ext active 181

EXT

CLASS: ACTIVE
START: 1996/03/22 14:00:00 FRI; STOP: 1996/03/22 14:07:50
FRI;
SLOWSAMPLES:          5; FASTSAMPLES:          47;
  KEY (EXT_FORMAT_CODE)
  INFO (EXTINFO)
    EXTSEIZ    EXTOVFL    EXTHI    EXTSEIZ2    EXTHI2

181 RLT_CONTEXT_EXT_BLOCK
    250
      3          0          1          0
      0

```

Group structure

OM group EXT provides one tuple for each EXT_FORMAT_CODE.

Key field:

EXT_FORMAT_CODE

Info field:

EXTINFO indicates the number of blocks provisioned.

EXT_FORMAT_CODE entries are listed in the following table.

EXT_FORMAT_CODE entries (Sheet 1 of 4)

Index	EXT_FORMAT_CODE	Office parameter name	Table
3	PERM	NUMPERMEXT	OFCENG
6	TOPSRU		
13	CAMATOPS_RU		
22	FEATURE_CONTROL_DATA	NO_OF_FTR_CONTROL_BLOCKS	OFCENG
24	WIDEBAND_EXT_BLOCK	WIDEBAND_EXT_BLOCK	
40	DCR_EXTENSION	NUM_DCR_EXT_BLKs	OFCENG
42	ISUP_EXTENSION_BLOCK	NUM_ISUP_EXT_BLKs	OFCENG

OM group EXT (continued)**EXT_FORMAT_CODE** entries (Sheet 2 of 4)

Index	EXT_FORMAT_CODE	Office parameter name	Table
43	SCRPAD_EXTEN_BLK	NUMBER_ECCB_SCRATCHPAD_A REAS	OFCENG
44	MCCS_EXTEN_BLK	NUMBER_ECCB_MCCS_AREAS_E XT	OFCENG
46	RDB_EXT_BLK		
47	FEATURE_XLA_DATA	NO_OF_FTR_XLA_BLKS	OFCENG
51	RU250_RECORDING_UNIT	NO_OF_DMS_250_REC_UNITS	OFCENG
52	RTEB_EXTENSION	NUM_OF_RTEB_EXTBLKS	
55	HISTORY_CONTROL_DATA		
56	GOSRU		
61	BASCPS_SMALL_EXT_BLK	NO_OF_SMALL_EXT_BLKS	OFCENG
62	BASCPS_LARGE_EXT_BLK	NO_OF_LARGE_EXT_BLKS	OFCENG
63	BASCPS_XLARGE_EXT_BLK	NO_OF_XLARGE_EXT_BLKS	OFCENG
66	EOPS_RECORDING_UNIT	NO_OF_EOPS_REC_UNITS	OFCENG
67	BASCPS_MEDIUM_EXT_BLK	NO_OF_MEDIUM_EXT_BLKS	OFCENG
69	DMS250_BBF_EXT_BLK_FC	NO_OF_DMS250_BBF_EXT_BLKS	OFCENG
70	TPBX_EXTENSION	NUM_TPBX_EXT_BLKS	OFCENG
73	EOPS_EXT_BLK	TOPS_NUM_RU	OFCENG
81	SMALL_FEATURE_DATA	NO_OF_SMALL_FTR_DATA_BLKS	OFCENG
82	MEDIUM_FEATURE_DATA	NO_OF_MEDIUM_FTR_DATA_BLK S	OFCENG
83	LARGE_FEATURE_DATA	NO_OF_LARGE_FTR_DATA_BLKS	OFCENG
85	XLA_EXT	MARKET_OF_OFFICE	OFCENG
86	CRITICAL_FEATURE_DATA	NO_OF_CRITICAL_FTR_DATA_BLK S	OFCENG
91	RC_EXT_BLK	NUM_RC_EXT_BLKS	

OM group EXT (continued)**EXT_FORMAT_CODE** entries (Sheet 3 of 4)

Index	EXT_FORMAT_CODE	Office parameter name	Table
92	DMS250_OCCB_EXT		
96	CRS_SUBRU_POOL1	CRS_SUBRU_POL1_SIZE	
97	CRS_SUBRU_POOL2	CRS_SUBRU_POOL2_SIZE	
98	CRS_SUBRU_POOL3	CRS_SUBRU_POOL3_SIZE	
99	CRS_SUBRU_POOL4	CRS_SUBRU_POOL4_SIZE	
100	CRS_PRU_POOL1	CRS_PRU_POOL1_SIZE	
101	CRS_PRU_POOL2	CRS_PRU_POOL2_SIZE	
106	SMALL_EE_EXT_BLK	NUM_SMALL_EE_EXT_BLKS	OFCENG
107	MEDIUM_EE_EXT_BLK	NUM_MEDIUM_EE_EXT_BLKS	OFCENG
108	LARGE_EE_EXT_BLK	NUM_LARGE_EE_EXT_BLKS	OFCENG
109	REGULAR_HISTORY_DATA	NO_OF_HIS_DATA_BLKS (Field 1)	OFCENG
110	LARGE_HISTORY_DATA	NO_OF_HIS_DATA_BLKS (Field 2)	OFCENG
111	EXTRA_LARGE_HISTORY_DATA	NO_OF_HIS_DATA_BLKS (Field 3)	OFCENG
114	SBS_EXTENSION_BLK		
115	CRS_PRU_POOL3	CRS_CRU_POOL3_SIZE	
119	TC_AP_COMPONENT_EXT_BLK		
142	PSN_PRIMITIVE_EXT		OFCENG
147	CRS_SUBRU_POOLS		
149	PSN_SCRATCHPAD_EXT		OFCENG
152	CAIN_FRAMEWORK_EXT_BLOCK	NUM_FRAMEWORK_EXT_BLKS	CAINPARAM
153	CAIN_EXT_BLOCK	NUM_CAIN_EXT_BLOCKS	CAINPARAM
156	PSN_SIGINFO_EXT		
176	CAIN_ECCB_BLOCK	NUM_CAIN_ECCBS	CAINPARAM
177	CAIN_STR_EXT_BLOCK	NUM_STR_EXT_BLOCKS	CAINPARAM

OM group EXT (continued)

EXT_FORMAT_CODE entries (Sheet 4 of 4)

Index	EXT_FORMAT_CODE	Office parameter name	Table
181	RLT_CONTEXT_EXT_BLK_FC	NUM_RLT_CONTEXT_EXT_BLKS	OFCENG
197	T_CAIN_EXT_BLOCK	NUM_T_CAIN_EXT_BLOCKS	CAINPARM

Associated OM groups

OM group CP provides information on the use of call processing software resources, such as call condense blocks, call processes, CP letters, multi-blocks, wake-up blocks, and long buffers.

OM group CP2 provides information on the use of extended call control blocks.

OM group FTRQ provides information on the use of feature queueing software resources.

Associated functional groups

All DMS switch office types are associated with OM group EXT.

Associated functionality codes

The functionality codes associated with OM group EXT are shown in the following table.

(Sheet 1 of 2)

Functionality	Code
CLASS-Call Setup (upgraded by NTXA00AB)	NTXA00AA
DMS-250 EOPS	NTXG12AA
DMS-250 EOPS (Type II)	NTXG12CA
Facility Broadcast Services	NTXR77AA
Data Call Tester	NTXS17AA
Common Basic	NTX001AA
DMS-250 Call Processing (Type II)	NTX222BA
DMS-250 Call Processing (Type III)	NTX222CA

OM group EXT (continued)

(Sheet 2 of 2)

Functionality	Code
TR448 ISDN Digit Analysis Compliance - End Office	NTX767AA
TR448 ISDN Digit Analysis Compliance - Toll	NTX68AA

The following flowcharts illustrate the use of extension registers.

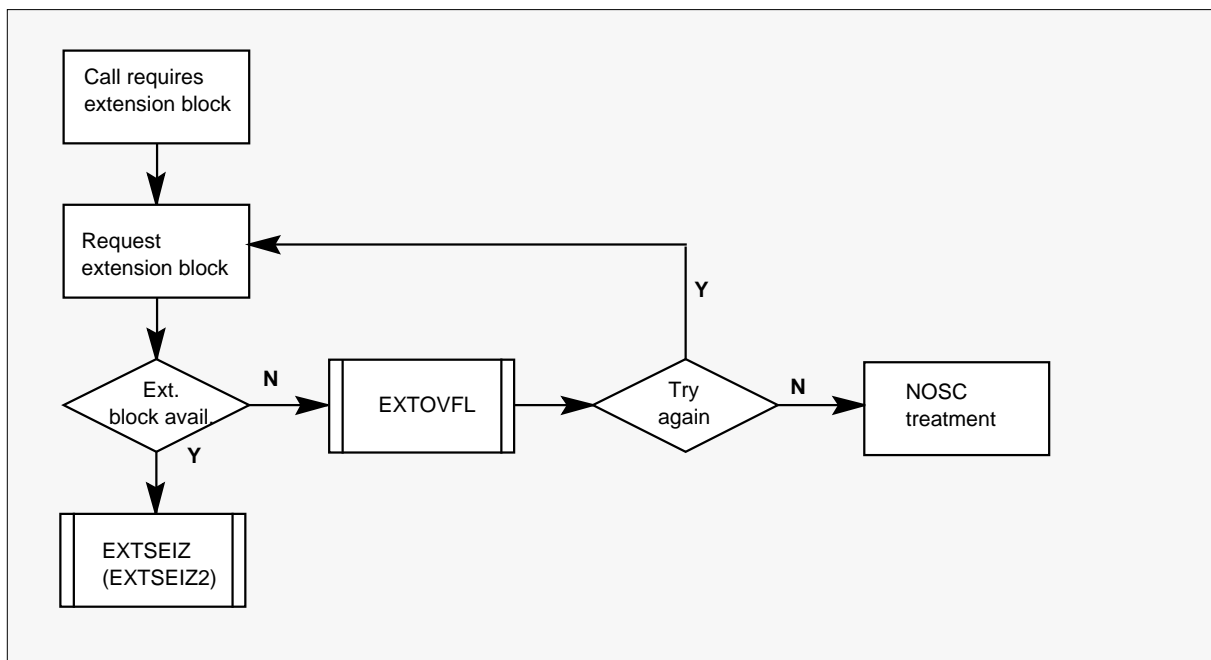
OM group EXT registers: registers

OM group EXT (continued)

OM group EXT registers: high water mark

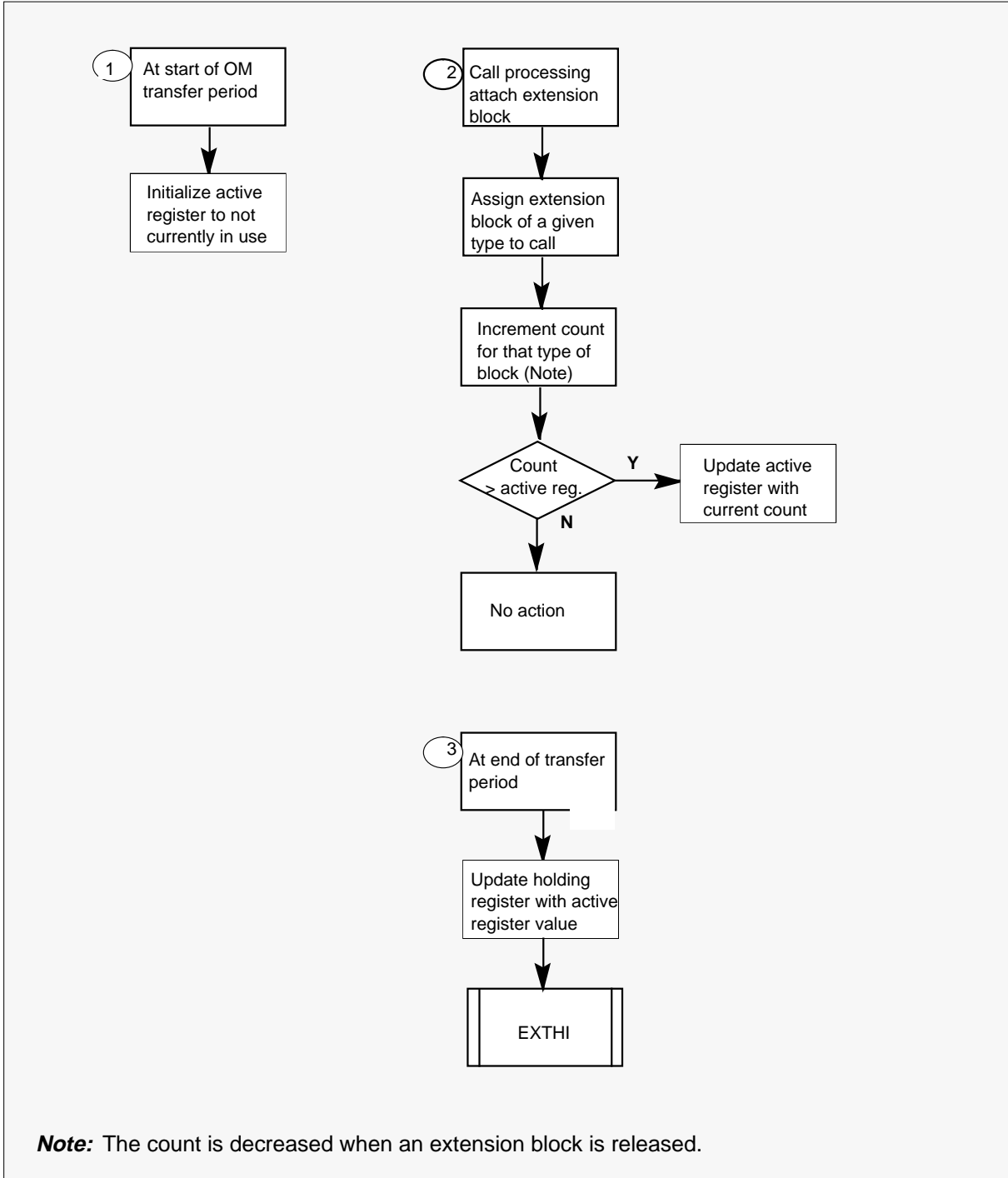

OM group EXT (continued)

Register EXTHI

Register EXTHI (Extension block high water)

EXTHI records the maximum number of extension blocks (of a specific type) that are in simultaneous use during the preceding OM transfer period (15 or 30 min.). To predict peak usage accurately, gather high water marks for the busiest hours of the busiest days of the year (following either the High Day Busy Hour or the Extreme Value Engineering provisioning concept). Use these data to calculate and adjust the provisioning of extension blocks, so that they are never more than about 80% utilized during the busiest times.

At the beginning of each transfer period, the active register initializes to the number of extension blocks that are currently in use. The active register updates continuously throughout the transfer period whenever the number of blocks that are currently in use exceeds the previously recorded value.

At the end of the transfer period (15 or 30 min.), the active register value transfers to the holding register (EXTHI) where it resides without change until it is overwritten at the end of the next transfer period.

True peak utilization can be predicted by taking the maximum value of all the high water marks observed during individual transfer periods during the busiest days of the year. An additional amount should be added to this value to ensure that the target 80% peak utilization of software resources is not exceeded, even during the busiest times. The calculated value is datafilled in the office parameter in table OFCENG for each particular type of extension block.

Register EXTHI release history

EXTHI was introduced in BCS23.

BCS31

EXTHI2 was added.

Associated registers

EXTHI replaces EXTUSAGE, which was deleted in BCS25.

Associated logs

None

Extension registers

EXTHI2

OM group EXT (end)

Register EXTOVFL

Register EXTOVFL (Extension block overflow)

EXTOVFL increments when a particular type of extension block requested for a call is not available. If call processing cannot allow the call to wait for a second attempt or if the occurrence is a second attempt failure, the call routes to no-service-circuit (NOSC) treatment.

If the count in this register is not zero, the provisioning of extension blocks of a given type must be reviewed. The number of extension blocks can be increased in table OFCENG.

Register EXTOVFL release history

EXTOVFL was introduced prior to BCS20.

Associated registers

None

Associated logs

None

Register EXTSEIZ

Extension block seizures

EXTSEIZ increments when a request for a particular type of extension block is successful.

Register EXTSEIZ release history

EXTSEIZ was introduced prior to BCS20.

BCS31

Extension register EXSEIZ2 added.

Associated registers

None

Associated logs

None

Extension register

EXTSEIZ2

OM group FBTRAFF

OM description

F-bus Platform Traffic

The operational measurement (OM) group FBTRAFF monitors traffic OMs for the following F-bus platforms in a DMS office:

- link interface unit (LIU7)
- high-speed link interface unit (HLIU)
- high-speed link router (HSLR)
- Ethernet interface unit (EIU)
- X.25 link interface unit (XLIU)
- application processing unit (APU)
- voice processing unit (VPU)
- network interface unit (NIU)
- frame relay transport unit (FRIU)

OM group FBTRAFF consists of 30 registers. These registers monitor the following:

- Total number of packets sent from the ASU to the F-bus host. Data that travels from the ASU to the F-bus host travels in the transmit direction.
- Total number of packets sent from the F-bus host to the ASU. Data that travels from the F-bus host to the ASU travels in the receive direction.
- Total number of octets that travel in the transmit direction.
- Total number of octets that travel in the receive direction.
- Percentage of total F-bus bandwidth occupied by transmit throughput.
- Percentage of total F-bus bandwidth occupied by receive throughput.
- Percentage of total F-bus bandwidth occupied by the sum of transmit and receive throughput.

Each item is measured separately for F-bus 0 and F-bus 1.

Extension registers

Numbers obtained by some of these calculations can contain too many digits to fit within a single register. Calculation results are therefore split into three extension registers. For example, the result of the calculation of the total number of transmit packets on F-bus 1 is split into registers TXPK1FB1, TXPK2FB1, and TXPK3FB1.

OM group FBTRAFF (continued)

To obtain the total value expressed in the three-register set, add the following values:

- The value in register 1
- The value in register 2 x 32768
- The value in register 3 x 327682

The following mathematical formula expresses this process:

$$\text{Total value} = R1 + (R2 \times 32\,768) + (R3 \times 32\,768\,2)$$

Note: Registers that calculate percentage values do not require extension registers.

Release history

OM group FBTRAFF was introduced in TL05.

Registers

The following OM group FBTRAFF registers appear on the MAP terminal as follows:

TXPK3FB0	TXPK2FB0	TXPK1FB0	RXPK3FB0
RXPK2FB0	RXPK1FB0	TXPK3FB1	TXPK2FB1
TXPK1FB1	RXPK3FB1	RXPK2FB1	RXPK1FB1
TXOC3FB0	TXOC2FB0	TXOC1FB0	RXOC3FB0
RXOC2FB0	RXOC1FB0	TXOC3FB1	TXOC2FB1
TXOC1FB1	RXOC3FB1	RXOC2FB1	RXOC1FB1
TXPCFB0	RXPCFB0	TXPCFB1	RXPCFB1
TXRPCFB0	TXRPCFB1		

Group structure

OM group FBTRAFF

Key field:

FBUS_CONTROLLERS

Info field:

HOST_INFO

OM group FBTRAFF (continued)

Associated OM groups

The following OM groups are associated with OM group FBTRAFF.

- ASUFBUS provides the number of octets and packets transmitted and received for an ASU on each F-bus port.
- NIUFBUS provides the number of octets and packets transmitted and received for a NIU on each F-bus port.

Associated functional groups

None

Associated functionality codes

The associated functionality codes for the OM group FBTRAFF appear in the following table.

Functionality	Code
CM Common	NTX941AA
Ethernet Interface Unit	NTX951AA
MS Common	NTXF05AA

Register TXPK1FB0

Register transmit packets 1 F-bus 0

TXPK1FB0 is the first register of the total number of transmit packets that travel over F-bus 0. The F-bus host is the message switch (MS) for the single shelf link peripheral processor (SSLPP) and for the DMS SuperNode SE (SNSE). The F-bus host is the local message switch (LMS) for the link peripheral processor (LPP) or enhanced link peripheral processor (ELPP). The value range of this register is 0 to 32 767.

Register TXPK1FB0 release history

Register TXPK1FB0 was introduced in TL05.

Associated registers

None

Associated logs

None

OM group FBTRAFF (continued)

Extension registers

TXPK2FB0, TXPK3FB0

Register RXPk1FB0

Register received packets 1 F-bus 0

RXPk1FB0 is the first register of the total number of receive packets that travel over F-bus 0. The F-bus host is the MS for the SSLPP and for the SNSE. The F-bus host is the LMS for the LPP or ELPP. The value range of this register is 0 to 32 767.

Register RXPk1FB0 release history

Register RXPk1FB0 was introduced in TL05.

Associated registers

None

Associated logs

None

Extension registers

RXPk2FB0, RXPk3FB0

Register TXPK1FB1

Register transmit packets 1 F-bus 1

TXPK1FB1 is the first register of the total number of transmit packets that travel over F-bus 1. The F-bus host is the MS for the SSLPP and for the SNSE. The F-bus host is the LMS for the LPP or ELPP. The value range of this register is 0 to 32 767.

Register TXPK1FB1 release history

Register TXPK1FB1 was introduced in TL05.

Associated registers

None

Associated logs

None

Extension registers

TXPK2FB1, TXPK3FB1

OM group FBTRAFF (continued)

Register RXPk1FB1

Register received packets 1 F-bus 1

RXPk1FB1 is the first register of the total number of receive packets that travel over F-bus 1. The F-bus host is the MS for the SSLPP and for the SNSE. The F-bus host is the LMS for the LPP or ELPP. The value range of this register is 0 to 32 767.

Register RXPk1FB1 release history

Register RXPk1FB1 was introduced in TL05.

Associated registers

None

Associated logs

None

Extension registers

RXPk2FB1, RXPk3FB1

Register TXOC1FB0

Register transmit octets 1 F-bus 0

TXOC1FB0 is the first register of the total number of transmit octets that travel over F-bus 0. The F-bus host is the MS for the SSLPP and for the SNSE. The F-bus host is the LMS for the LPP or ELPP. The value range of this register is 0 to 32 767.

Register TXOC1FB0 release history

Register TXOC1FB0 was introduced in TL05.

Associated registers

None

Associated logs

None

Extension registers

TXOC2FB0, TXOC3FB0

Register RXOC1FB0

Register received octets 1 F-bus 0

OM group FBTRAFF (continued)

RXOC1FB0 is the first register of the total number of receive octets that travel over F-bus 0. The F-bus host is the MS for the SSLPP and for the SNSE. The F-bus host is the LMS for the LPP or ELPP. The value range of this register is 0 to 32 767.

Register RXOC1FB0 release history

Register RXOC1FB0 was introduced in TL05.

Associated registers

None

Associated logs

None

Extension registers

RXOC2FB0, RXOC3FB0

Register TXOC1FB1

Register transmit octets 1 F-bus 1

TXOC1FB1 is the first register of the total number of transmit octets that travel over F-bus 1. The F-bus host is the MS for the SSLPP and for the SNSE. The F-bus host is the LMS for the LPP or ELPP. The value range of this register is 0 to 32 767.

Register TXOC1FB1 release history

Register TXOC1FB1 was introduced in TL05.

Associated registers

None

Associated logs

None

Extension registers

TXOC2FB1, TXOC3FB1

Register RXOC1FB1

Register received octets 1 F-bus 1

RXOC1FB1 is the first register of the total number of receive octets that travel over F-bus 1. The F-bus host is the MS for the SSLPP and for the SNSE. The

OM group FBTRAFF (continued)

F-bus host is the LMS for the LPP or ELPP. The value range of this register is 0 to 32 767.

Register RXOC1FB1 release history

Register RXOC1FB1 was introduced in TL05.

Associated registers

None

Associated logs

None

Extension registers

RXOC2FB1, RXOC3FB1

Register TXPCFB0

Register percentage transmit on F-bus 0

Register TXPCFB0 monitors the percentage of total F-bus 0 bandwidth occupied by transmit traffic. The F-bus host is the MS for the SSLPP and for the SNSE. The F-bus host is the LMS for the LPP or ELPP. Total bandwidth of an ELPP is up to three times the bandwidth of an LPP. The value range of this register is 0 to 100.

Register TXPCFB0 release history

Register TXPCFB0 was introduced in TL05.

Associated registers

TXOC1FB0, TXOC2FB0, TXOC3FB0

Associated logs

None

Extension registers

None

Register RXPCFB0

Register percentage received on F-bus 0

Register RXPCFB0 monitors the percentage of total F-bus 0 bandwidth occupied by receive traffic. The F-bus host is the MS for the SSLPP and for the SNSE. The F-bus host is the LMS for the LPP or ELPP. Total bandwidth

OM group FBTRAFF (continued)

of an ELPP is up to three times the bandwidth of an LPP. The value range of this register is 0 to 100.

Register RXPCFB0 release history

Register RXPCFB0 was introduced in TL05.

Associated registers

RXOC1FB0, RXOC2FB0, RXOC3FB0

Associated logs

None

Extension registers

None

Register TXPCFB1

Register transmitted percentage on F-bus 1

Register TXPCFB1 monitors the percentage of total F-bus 1 bandwidth occupied by transmit and receive traffic. The F-bus host is the MS for the SSLPP and for the SNSE. The F-bus host is the LMS for the LPP or ELPP. Total bandwidth of an ELPP is up to three times the bandwidth of an LPP. The value range of this register is 0 to 100.

Register TXPCFB1 release history

Register TXPCFB1 was introduced in TL05.

Associated registers

TXOC1FB1, TXOC2FB1, TXOC3FB1

Associated logs

None

Extension registers

None

Register RXPCFB1

Register received percentage on F-bus 1

Register RXPCFB1 monitors the percentage of total F-bus 1 bandwidth occupied by transmit and receive traffic. The F-bus host is the MS for the SSLPP and for the SNSE. The F-bus host is the LMS for the LPP or ELPP.

OM group FBTRAFF (continued)

Total bandwidth of an ELPP is up to three times the bandwidth of an LPP. The value range of this register is 0 to 100.

Register RXPCFB1 release history

Register RXPCFB1 was introduced in TL05.

Associated registers

RXOC1FB1, RXOC2FB1, RXOC3FB1

Associated logs

None

Extension registers

None

Register TXRPCFB0

Register transmitted and received percentage of F-bus 0

Register TXRPCFB0 monitors the percentage of total F-bus 0 bandwidth occupied by transmit and receive traffic. The F-bus host is the MS for the SSLPP and for the SNSE. The F-bus host is the LMS for the LPP or ELPP. Total bandwidth of an ELPP is up to three times the bandwidth of an LPP. The value range of this register is 0 to 100.

Register TXRPCFB0 release history

Register TXRPCFB0 was introduced in TL05.

Associated registers

TXOC1FB0, TXOC2FB0, TXOC3FB0, RXOC1FB0, RXOC2FB0, RXOC3FB0

Associated logs

None

Extension registers

None

Register TXRPCFB1

Register transmitted and received percentage of F-bus 1

Register TXRPCFB1 monitors the percentage of total F-bus 1 bandwidth occupied by transmit and receive traffic. The F-bus host is the MS for the SSLPP and for the SNSE. The F-bus host is the LMS for the LPP or ELPP.

OM group FBTRAFF (end)

Total bandwidth of an ELPP is up to three times the bandwidth of an LPP. The value range of this register is 0 to 100.

Register TXRPCFB1 release history

Register TXRPCFB1 was introduced in TL05.

Associated registers

TXOC1FB1, TXOC2FB1, TXOC3FB1, RXOC1FB1, RXOC2FB1, RXOC3FB1

Associated logs

None

Extension registers

None

OM group FCDRALGR

OM description

The Flexible Call Detail Record (FlexCDR) Algorithm (FCDRALGR) group provides OMs for counting the CDR template method used to format the CDRs. For additional information on billing, refer to the *UCS DMS-250 Billing Records Application Guide*.

Release history

SN07 (DMS)

Extension OM group FCDRALG2 was added by feature A00002340. This OM group is controlled by SOC code UBFR0008.

SN06 (DMS)

The following register names were corrected for CR Q00762902. ICF was corrected to INTERNAL, SNV was corrected to SUBRNUM, and AIN was corrected to TCAP.

UCS05

OM group FCDRALGR was introduced in UCS05.

Registers

OM group FCDRALGR registers display on the MAP terminal as follows:

INTERNAL	CALLTYPE	SUBRNUM	TRK
TCAP	FIXED	BESTFIT	RTEATTR

Associated OM groups

None

OM group FCDRALGR (continued)

Registers for FCDRALGR

The FCDRALGR OM group consists of eight registers.

Register name (acronym)	Register name (expanded)	Information
INTERNAL	Internal CDR Format	<p><i>Description:</i></p> <p>Counts the number of times the internal formatting algorithm is used while selecting a formatting method</p> <p><i>Associated registers:</i> None</p> <p><i>EXT registers:</i> FCDRALG2</p> <p><i>Register validation:</i> None</p> <p><i>Associated logs:</i> None</p>
CALLTYPE	Calltype Flexdial	<p><i>Description:</i></p> <p>Counts the number of times the CDR format is selected through call processing by a template provisioned using the CDRTMPLT option for the CALLTYPE collectible using the FlexDial framework</p> <p><i>Associated registers:</i> None</p> <p><i>EXT registers:</i> FCDRALG2</p> <p><i>Register validation:</i> None</p> <p><i>Associated logs:</i> None</p>
SUBRNUM	Subscriber Number Validation	<p><i>Description:</i></p> <p>Counts the number of times the CDR format is selected through call processing by a template provisioned using the CDRTMPLT option in tables AUTHCODU, AUTHCDU2, AUTHCDU3, AUTHCDU4, AUTHCDU5, or ANISCUSP</p> <p><i>Associated registers:</i> None</p> <p><i>EXT registers:</i> FCDRALG2</p> <p><i>Register validation:</i> None</p> <p><i>Associated logs:</i> None</p>

OM group FCDRALGR (continued)

Register name (acronym)	Register name (expanded)	Information
TRK	TRKGRP/TRKFEAT	<p><i>Description:</i></p> <p>Counts the number of times the CDR format is selected through call processing by a template provisioned using the CDRTMPLT option in tables TRKGRP or TRKFEAT</p> <p><i>Associated registers:</i> None</p> <p><i>EXT registers:</i> FCDRALG2</p> <p><i>Register validation:</i> None</p> <p><i>Associated logs:</i> None</p>
TCAP	AIN Indicator	<p><i>Description:</i></p> <p>Counts the number of times the CDR format is selected through call processing by a template provisioned in table FLEXTYPE. This is triggered by an SCP TCAP message.</p> <p><i>Associated registers:</i> None</p> <p><i>EXT registers:</i> FCDRALG2</p> <p><i>Register validation:</i> None</p> <p><i>Associated logs:</i> None</p>
FIXED	Fixed	<p><i>Description:</i></p> <p>Counts the number of times a fixed CDR template is used to format the CDR</p> <p><i>Associated registers:</i> None</p> <p><i>EXT registers:</i> FCDRALG2</p> <p><i>Register validation:</i> None</p> <p><i>Associated logs:</i> None</p>

OM group FCDRALGR (end)

Register name (acronym)	Register name (expanded)	Information
BESTFIT	Bestfit	<i>Description:</i> Counts the number of times a bestfit analysis is used to determine the CDR template used to format the CDR <i>Associated registers:</i> None <i>EXT registers:</i> FCDRALG2 <i>Register validation:</i> None <i>Associated logs:</i> None
RTEATTR	Table RTEATTR	<i>Description:</i> Counts the number of times the CDR format is selected through call processing by a template provisioned using the CDRTMPLT option in table RTEATTR <i>Associated registers:</i> None <i>EXT registers:</i> FCDRALG2 <i>Register validation:</i> None <i>Associated logs:</i> None

Associated logs

None

OM group FCDRLOG

OM description

The Flexible Call Detail Record (FlexCDR) Log (FCDRLOG) group provides OMs for counting the CDRs formatted with padded data, truncated data, missing data, or wasted space.

Release history

OM group FCDRLOG is introduced in UCS06.

Registers

The following OM group FCDRLOG registers display on the MAP terminal as follows:



LOG_300 LOG_600 LOG_601 LOG_602

Associated OM groups

None

OM group FCDRLOG (continued)**Registers for FCDRALGR**

The FCDRALGR OM group consists of seventeen registers.

Register name (acronym)	Register name (expanded)	Information
LOG_300	FCDR300	<p><i>Description:</i></p> <p>Counts the number of times an FCDR300 log is generated</p> <p><i>Associated registers:</i> None</p> <p><i>EXT registers:</i> None</p> <p><i>Register validation:</i> None</p> <p><i>Associated logs:</i> FCDR300</p>
LOG_600	FCDR600	<p><i>Description:</i></p> <p>Counts the number of times an FCDR600 log is generated</p> <p><i>Associated registers:</i> None</p> <p><i>EXT registers:</i> None</p> <p><i>Register validation:</i> None</p> <p><i>Associated logs:</i> FCDR600</p>
LOG_601	FCDR601	<p><i>Description:</i></p> <p>Counts the number of times an FCDR601 log is generated</p> <p><i>Associated registers:</i> None</p> <p><i>EXT registers:</i> None</p> <p><i>Register validation:</i> None</p> <p><i>Associated logs:</i> FCDR601</p>
LOG_602	FCDR602	<p><i>Description:</i></p> <p>Counts the number of times an FCDR602 log is generated</p> <p><i>Associated registers:</i> None</p> <p><i>EXT registers:</i> None</p> <p><i>Register validation:</i> None</p> <p><i>Associated logs:</i> FCDR602</p>

OM group FCDRLOG (end)

Associated logs

None

OM group FCDRTMP1

OM description

The Flexible Call Detail Record Template (FCDRTMP1) OM group counts the number of times a templates 0 through 31 are used to format a CDR.

Release history

SN07 (DMS)

Extension OM group FCDRTM1E was added by feature A00002340.
Extension OM group FCDRTM1E is controlled by SOC code UBFR0008.

UCS06

OM group FCDRTMP1 was introduced in UCS06.

Registers

OM group FCDRTMP1 registers display on the MAP terminal as follows:

```
INFO (FCDR_TMPLT1_FLDS)
  TMPLT_0      TMPLT_1      TMPLT_2      TMPLT_3
  TMPLT_4      TMPLT_5      TMPLT_6      TMPLT_7
  TMPLT_8      TMPLT_9      TMPLT_10     TMPLT_11
  TMPLT_12     TMPLT_13     TMPLT_14     TMPLT_15
  TMPLT_16     TMPLT_17     TMPLT_18     TMPLT_19
  TMPLT_20     TMPLT_21     TMPLT_22     TMPLT_23
  TMPLT_24     TMPLT_25     TMPLT_26     TMPLT_27
  TMPLT_28     TMPLT_29     TMPLT_30     TMPLT_31
```

Associated OM groups

FCDRTMP2

OM group FCDRTMP1 (continued)**Registers for FCDRTMP1**

The FCDRTMP1 OM group consists of 32 registers.

Register name (acronym)	Register name (expanded)	Information
TMPLT_0	Template 0	<p><i>Description:</i></p> <p>Counts the number of times the template at index 0 is used to format a CDR</p> <p><i>Associated registers:</i> None</p> <p><i>EXT registers:</i> FCDRTM1E</p> <p><i>Register validation:</i> None</p> <p><i>Associated logs:</i> None</p>
TMPLT_1	Template 1	<p><i>Description:</i></p> <p>Counts the number of times the template at index 1 is used to format a CDR</p> <p><i>Associated registers:</i> None</p> <p><i>EXT registers:</i> FCDRTM1E</p> <p><i>Register validation:</i> None</p> <p><i>Associated logs:</i> None</p>
TMPLT_2	Template 2	<p><i>Description:</i></p> <p>Counts the number of times the template at index 2 is used to format a CDR</p> <p><i>Associated registers:</i> None</p> <p><i>EXT registers:</i> FCDRTM1E</p> <p><i>Register validation:</i> None</p> <p><i>Associated logs:</i> None</p>
TMPLT_3	Template 3	<p><i>Description:</i></p> <p>Counts the number of times the template at index 3 is used to format a CDR</p> <p><i>Associated registers:</i> None</p> <p><i>EXT registers:</i> FCDRTM1E</p> <p><i>Register validation:</i> None</p> <p><i>Associated logs:</i> None</p>

OM group FCDRTMP1 (continued)

Register name (acronym)	Register name (expanded)	Information
TMPLT_4	Template 4	<p><i>Description:</i></p> <p>Counts the number of times the template at index 4 is used to format a CDR</p> <p><i>Associated registers:</i> None</p> <p><i>EXT registers:</i> FCDRTM1E</p> <p><i>Register validation:</i> None</p> <p><i>Associated logs:</i> None</p>
TMPLT_5	Template 5	<p><i>Description:</i></p> <p>Counts the number of times the template at index 5 is used to format a CDR</p> <p><i>Associated registers:</i> None</p> <p><i>EXT registers:</i> FCDRTM1E</p> <p><i>Register validation:</i> None</p> <p><i>Associated logs:</i> None</p>
TMPLT_6	Template 6	<p><i>Description:</i></p> <p>Counts the number of times the template at index 6 is used to format a CDR</p> <p><i>Associated registers:</i> None</p> <p><i>EXT registers:</i> FCDRTM1E</p> <p><i>Register validation:</i> None</p> <p><i>Associated logs:</i> None</p>
TMPLT_7	Template 7	<p><i>Description:</i></p> <p>Counts the number of times the template at index 7 is used to format a CDR</p> <p><i>Associated registers:</i> None</p> <p><i>EXT registers:</i> FCDRTM1E</p> <p><i>Register validation:</i> None</p> <p><i>Associated logs:</i> None</p>

OM group FCDRTMP1 (continued)

Register name (acronym)	Register name (expanded)	Information
TMPLT_8	Template 8	<p><i>Description:</i></p> <p>Counts the number of times the template at index 8 is used to format a CDR</p> <p><i>Associated registers:</i> None</p> <p><i>EXT registers:</i> FCDRTM1E</p> <p><i>Register validation:</i> None</p> <p><i>Associated logs:</i> None</p>
TMPLT_9	Template 9	<p><i>Description:</i></p> <p>Counts the number of times the template at index 9 is used to format a CDR</p> <p><i>Associated registers:</i> None</p> <p><i>EXT registers:</i> FCDRTM1E</p> <p><i>Register validation:</i> None</p> <p><i>Associated logs:</i> None</p>
TMPLT_10	Template 10	<p><i>Description:</i></p> <p>Counts the number of times the template at index 10 is used to format a CDR</p> <p><i>Associated registers:</i> None</p> <p><i>EXT registers:</i> FCDRTM1E</p> <p><i>Register validation:</i> None</p> <p><i>Associated logs:</i> None</p>
TMPLT_11	Template 11	<p><i>Description:</i></p> <p>Counts the number of times the template at index 11 is used to format a CDR</p> <p><i>Associated registers:</i> None</p> <p><i>EXT registers:</i> FCDRTM1E</p> <p><i>Register validation:</i> None</p> <p><i>Associated logs:</i> None</p>

OM group FCDRTMP1 (continued)

Register name (acronym)	Register name (expanded)	Information
TMPLT_12	Template 12	<p><i>Description:</i></p> <p>Counts the number of times the template at index 12 is used to format a CDR</p> <p><i>Associated registers:</i> None</p> <p><i>EXT registers:</i> FCDRTM1E</p> <p><i>Register validation:</i> None</p> <p><i>Associated logs:</i> None</p>
TMPLT_13	Template 13	<p><i>Description:</i></p> <p>Counts the number of times the template at index 13 is used to format a CDR</p> <p><i>Associated registers:</i> None</p> <p><i>EXT registers:</i> FCDRTM1E</p> <p><i>Register validation:</i> None</p> <p><i>Associated logs:</i> None</p>
TMPLT_14	Template 14	<p><i>Description:</i></p> <p>Counts the number of times the template at index 14 is used to format a CDR</p> <p><i>Associated registers:</i> None</p> <p><i>EXT registers:</i> FCDRTM1E</p> <p><i>Register validation:</i> None</p> <p><i>Associated logs:</i> None</p>
TMPLT_15	Template 15	<p><i>Description:</i></p> <p>Counts the number of times the template at index 15 is used to format a CDR</p> <p><i>Associated registers:</i> None</p> <p><i>EXT registers:</i> FCDRTM1E</p> <p><i>Register validation:</i> None</p> <p><i>Associated logs:</i> None</p>

OM group FCDRTMP1 (continued)

Register name (acronym)	Register name (expanded)	Information
TMPLT_16	Template 16	<p><i>Description:</i></p> <p>Counts the number of times the template at index 16 is used to format a CDR</p> <p><i>Associated registers:</i> None</p> <p><i>EXT registers:</i> FCDRTM1E</p> <p><i>Register validation:</i> None</p> <p><i>Associated logs:</i> None</p>
TMPLT_17	Template 17	<p><i>Description:</i></p> <p>Counts the number of times the template at index 17 is used to format a CDR</p> <p><i>Associated registers:</i> None</p> <p><i>EXT registers:</i> FCDRTM1E</p> <p><i>Register validation:</i> None</p> <p><i>Associated logs:</i> None</p>
TMPLT_18	Template 18	<p><i>Description:</i></p> <p>Counts the number of times the template at index 18 is used to format a CDR</p> <p><i>Associated registers:</i> None</p> <p><i>EXT registers:</i> FCDRTM1E</p> <p><i>Register validation:</i> None</p> <p><i>Associated logs:</i> None</p>
TMPLT_19	Template 19	<p><i>Description:</i></p> <p>Counts the number of times the template at index 19 is used to format a CDR</p> <p><i>Associated registers:</i> None</p> <p><i>EXT registers:</i> FCDRTM1E</p> <p><i>Register validation:</i> None</p> <p><i>Associated logs:</i> None</p>

OM group FCDRTMP1 (continued)

Register name (acronym)	Register name (expanded)	Information
TMPLT_20	Template 20	<p><i>Description:</i></p> <p>Counts the number of times the template at index 20 is used to format a CDR</p> <p><i>Associated registers:</i> None</p> <p><i>EXT registers:</i> FCDRTM1E</p> <p><i>Register validation:</i> None</p> <p><i>Associated logs:</i> None</p>
TMPLT_21	Template 21	<p><i>Description:</i></p> <p>Counts the number of times the template at index 21 is used to format a CDR</p> <p><i>Associated registers:</i> None</p> <p><i>EXT registers:</i> FCDRTM1E</p> <p><i>Register validation:</i> None</p> <p><i>Associated logs:</i> None</p>
TMPLT_22	Template 22	<p><i>Description:</i></p> <p>Counts the number of times the template at index 22 is used to format a CDR</p> <p><i>Associated registers:</i> None</p> <p><i>EXT registers:</i> FCDRTM1E</p> <p><i>Register validation:</i> None</p> <p><i>Associated logs:</i> None</p>
TMPLT_23	Template 23	<p><i>Description:</i></p> <p>Counts the number of times the template at index 23 is used to format a CDR</p> <p><i>Associated registers:</i> None</p> <p><i>EXT registers:</i> FCDRTM1E</p> <p><i>Register validation:</i> None</p> <p><i>Associated logs:</i> None</p>

OM group FCDRTMP1 (continued)

Register name (acronym)	Register name (expanded)	Information
TMPLT_24	Template 24	<p><i>Description:</i></p> <p>Counts the number of times the template at index 24 is used to format a CDR</p> <p><i>Associated registers:</i> None</p> <p><i>EXT registers:</i> FCDRTM1E</p> <p><i>Register validation:</i> None</p> <p><i>Associated logs:</i> None</p>
TMPLT_25	Template 25	<p><i>Description:</i></p> <p>Counts the number of times the template at index 25 is used to format a CDR</p> <p><i>Associated registers:</i> None</p> <p><i>EXT registers:</i> FCDRTM1E</p> <p><i>Register validation:</i> None</p> <p><i>Associated logs:</i> None</p>
TMPLT_26	Template 26	<p><i>Description:</i></p> <p>Counts the number of times the template at index 26 is used to format a CDR</p> <p><i>Associated registers:</i> None</p> <p><i>EXT registers:</i> FCDRTM1E</p> <p><i>Register validation:</i> None</p> <p><i>Associated logs:</i> None</p>
TMPLT_27	Template 27	<p><i>Description:</i></p> <p>Counts the number of times the template at index 27 is used to format a CDR</p> <p><i>Associated registers:</i> None</p> <p><i>EXT registers:</i> FCDRTM1E</p> <p><i>Register validation:</i> None</p> <p><i>Associated logs:</i> None</p>

OM group FCDRTMP1 (end)

Register name (acronym)	Register name (expanded)	Information
TMPLT_28	Template 28	<p><i>Description:</i></p> <p>Counts the number of times the template at index 28 is used to format a CDR</p> <p><i>Associated registers:</i> None</p> <p><i>EXT registers:</i> FCDRTM1E</p> <p><i>Register validation:</i> None</p> <p><i>Associated logs:</i> None</p>
TMPLT_29	Template 29	<p><i>Description:</i></p> <p>Counts the number of times the template at index 29 is used to format a CDR</p> <p><i>Associated registers:</i> None</p> <p><i>EXT registers:</i> FCDRTM1E</p> <p><i>Register validation:</i> None</p> <p><i>Associated logs:</i> None</p>
TMPLT_30	Template 30	<p><i>Description:</i></p> <p>Counts the number of times the template at index 30 is used to format a CDR</p> <p><i>Associated registers:</i> None</p> <p><i>EXT registers:</i> FCDRTM1E</p> <p><i>Register validation:</i> None</p> <p><i>Associated logs:</i> None</p>
TMPLT_31	Template 31	<p><i>Description:</i></p> <p>Counts the number of times the template at index 31 is used to format a CDR</p> <p><i>Associated registers:</i> None</p> <p><i>EXT registers:</i> FCDRTM1E</p> <p><i>Register validation:</i> None</p> <p><i>Associated logs:</i> None</p>

Associated logs

None

OM group FCDRTMP2

OM description

The Flexible Call Detail Record Template (FCDRTMP2) OM group counts the number of times templates 32 through 63 are used to format a CDR.

Release history

SN07 (DMS)

Extension OM group FCDRTM2E was added by feature A00002340.
Extension OM group FCDRTM2E is controlled by SOC code UBFR0008.

UCS06

OM group FCDRTMP2 was introduced in UCS06.

Registers

OM group FCDRTMP2 registers display on the MAP terminal as follows:

```
INFO (FCDR_TMPLT1_FLDS)
TMPLT_32  TMPLT_33  TMPLT_34  TMPLT_35
TMPLT_36  TMPLT_37  TMPLT_38  TMPLT_39
TMPLT_40  TMPLT_41  TMPLT_42  TMPLT_43
TMPLT_44  TMPLT_45  TMPLT_46  TMPLT_47
TMPLT_48  TMPLT_49  TMPLT_50  TMPLT_51
TMPLT_52  TMPLT_53  TMPLT_54  TMPLT_55
TMPLT_56  TMPLT_57  TMPLT_58  TMPLT_59
TMPLT_60  TMPLT_61  TMPLT_62  TMPLT_63
```

Associated OM groups

FCDRTMP1

OM group FCDRTMP2 (continued)**Registers for FCDRTMP2**

The FCDRTMP2 OM group consists of 32 registers.

Register name (acronym)	Register name (expanded)	Information
TMPLT_32	Template 32	<p><i>Description:</i></p> <p>Counts the number of times the template at index 32 is used to format a CDR</p> <p><i>Associated registers:</i> None</p> <p><i>EXT registers:</i> FCDRTM2E</p> <p><i>Register validation:</i> None</p> <p><i>Associated logs:</i> None</p>
TMPLT_33	Template 33	<p><i>Description:</i></p> <p>Counts the number of times the template at index 33 is used to format a CDR</p> <p><i>Associated registers:</i> None</p> <p><i>EXT registers:</i> FCDRTM2E</p> <p><i>Register validation:</i> None</p> <p><i>Associated logs:</i> None</p>
TMPLT_34	Template 34	<p><i>Description:</i></p> <p>Counts the number of times the template at index 34 is used to format a CDR</p> <p><i>Associated registers:</i> None</p> <p><i>EXT registers:</i> FCDRTM2E</p> <p><i>Register validation:</i> None</p> <p><i>Associated logs:</i> None</p>
TMPLT_35	Template 35	<p><i>Description:</i></p> <p>Counts the number of times the template at index 35 is used to format a CDR</p> <p><i>Associated registers:</i> None</p> <p><i>EXT registers:</i> FCDRTM2E</p> <p><i>Register validation:</i> None</p> <p><i>Associated logs:</i> None</p>

OM group FCDRTMP2 (continued)

Register name (acronym)	Register name (expanded)	Information
TMPLT_36	Template 36	<p><i>Description:</i></p> <p>Counts the number of times the template at index 36 is used to format a CDR</p> <p><i>Associated registers:</i> None</p> <p><i>EXT registers:</i> FCDRTM2E</p> <p><i>Register validation:</i> None</p> <p><i>Associated logs:</i> None</p>
TMPLT_37	Template 37	<p><i>Description:</i></p> <p>Counts the number of times the template at index 37 is used to format a CDR</p> <p><i>Associated registers:</i> None</p> <p><i>EXT registers:</i> FCDRTM2E</p> <p><i>Register validation:</i> None</p> <p><i>Associated logs:</i> None</p>
TMPLT_38	Template 38	<p><i>Description:</i></p> <p>Counts the number of times the template at index 38 is used to format a CDR</p> <p><i>Associated registers:</i> None</p> <p><i>EXT registers:</i> FCDRTM2E</p> <p><i>Register validation:</i> None</p> <p><i>Associated logs:</i> None</p>
TMPLT_39	Template 39	<p><i>Description:</i></p> <p>Counts the number of times the template at index 39 is used to format a CDR</p> <p><i>Associated registers:</i> None</p> <p><i>EXT registers:</i> FCDRTM2E</p> <p><i>Register validation:</i> None</p> <p><i>Associated logs:</i> None</p>

OM group FCDRTMP2 (continued)

Register name (acronym)	Register name (expanded)	Information
TMPLT_40	Template 40	<p><i>Description:</i></p> <p>Counts the number of times the template at index 40 is used to format a CDR</p> <p><i>Associated registers:</i> None</p> <p><i>EXT registers:</i> FCDRTM2E</p> <p><i>Register validation:</i> None</p> <p><i>Associated logs:</i> None</p>
TMPLT_41	Template 41	<p><i>Description:</i></p> <p>Counts the number of times the template at index 41 is used to format a CDR</p> <p><i>Associated registers:</i> None</p> <p><i>EXT registers:</i> FCDRTM2E</p> <p><i>Register validation:</i> None</p> <p><i>Associated logs:</i> None</p>
TMPLT_42	Template 42	<p><i>Description:</i></p> <p>Counts the number of times the template at index 42 is used to format a CDR</p> <p><i>Associated registers:</i> None</p> <p><i>EXT registers:</i> FCDRTM2E</p> <p><i>Register validation:</i> None</p> <p><i>Associated logs:</i> None</p>
TMPLT_43	Template 43	<p><i>Description:</i></p> <p>Counts the number of times the template at index 43 is used to format a CDR</p> <p><i>Associated registers:</i> None</p> <p><i>EXT registers:</i> FCDRTM2E</p> <p><i>Register validation:</i> None</p> <p><i>Associated logs:</i> None</p>

OM group FCDRTMP2 (continued)

Register name (acronym)	Register name (expanded)	Information
TMPLT_44	Template 44	<p><i>Description:</i></p> <p>Counts the number of times the template at index 44 is used to format a CDR</p> <p><i>Associated registers:</i> None</p> <p><i>EXT registers:</i> FCDRTM2E</p> <p><i>Register validation:</i> None</p> <p><i>Associated logs:</i> None</p>
TMPLT_45	Template 45	<p><i>Description:</i></p> <p>Counts the number of times the template at index 45 is used to format a CDR</p> <p><i>Associated registers:</i> None</p> <p><i>EXT registers:</i> FCDRTM2E</p> <p><i>Register validation:</i> None</p> <p><i>Associated logs:</i> None</p>
TMPLT_46	Template 46	<p><i>Description:</i></p> <p>Counts the number of times the template at index 46 is used to format a CDR</p> <p><i>Associated registers:</i> None</p> <p><i>EXT registers:</i> FCDRTM2E</p> <p><i>Register validation:</i> None</p> <p><i>Associated logs:</i> None</p>
TMPLT_47	Template 47	<p><i>Description:</i></p> <p>Counts the number of times the template at index 47 is used to format a CDR</p> <p><i>Associated registers:</i> None</p> <p><i>EXT registers:</i> FCDRTM2E</p> <p><i>Register validation:</i> None</p> <p><i>Associated logs:</i> None</p>

OM group FCDRTMP2 (continued)

Register name (acronym)	Register name (expanded)	Information
TMPLT_48	Template 48	<p><i>Description:</i></p> <p>Counts the number of times the template at index 48 is used to format a CDR</p> <p><i>Associated registers:</i> None</p> <p><i>EXT registers:</i> FCDRTM2E</p> <p><i>Register validation:</i> None</p> <p><i>Associated logs:</i> None</p>
TMPLT_49	Template 49	<p><i>Description:</i></p> <p>Counts the number of times the template at index 49 is used to format a CDR</p> <p><i>Associated registers:</i> None</p> <p><i>EXT registers:</i> FCDRTM2E</p> <p><i>Register validation:</i> None</p> <p><i>Associated logs:</i> None</p>
TMPLT_50	Template 50	<p><i>Description:</i></p> <p>Counts the number of times the template at index 50 is used to format a CDR</p> <p><i>Associated registers:</i> None</p> <p><i>EXT registers:</i> FCDRTM2E</p> <p><i>Register validation:</i> None</p> <p><i>Associated logs:</i> None</p>
TMPLT_51	Template 51	<p><i>Description:</i></p> <p>Counts the number of times the template at index 51 is used to format a CDR</p> <p><i>Associated registers:</i> None</p> <p><i>EXT registers:</i> FCDRTM2E</p> <p><i>Register validation:</i> None</p> <p><i>Associated logs:</i> None</p>

OM group FCDRTMP2 (continued)

Register name (acronym)	Register name (expanded)	Information
TMPLT_52	Template 52	<p><i>Description:</i></p> <p>Counts the number of times the template at index 52 is used to format a CDR</p> <p><i>Associated registers:</i> None</p> <p><i>EXT registers:</i> FCDRTM2E</p> <p><i>Register validation:</i> None</p> <p><i>Associated logs:</i> None</p>
TMPLT_53	Template 53	<p><i>Description:</i></p> <p>Counts the number of times the template at index 53 is used to format a CDR</p> <p><i>Associated registers:</i> None</p> <p><i>EXT registers:</i> FCDRTM2E</p> <p><i>Register validation:</i> None</p> <p><i>Associated logs:</i> None</p>
TMPLT_54	Template 54	<p><i>Description:</i></p> <p>Counts the number of times the template at index 54 is used to format a CDR</p> <p><i>Associated registers:</i> None</p> <p><i>EXT registers:</i> FCDRTM2E</p> <p><i>Register validation:</i> None</p> <p><i>Associated logs:</i> None</p>
TMPLT_55	Template 55	<p><i>Description:</i></p> <p>Counts the number of times the template at index 55 is used to format a CDR</p> <p><i>Associated registers:</i> None</p> <p><i>EXT registers:</i> FCDRTM2E</p> <p><i>Register validation:</i> None</p> <p><i>Associated logs:</i> None</p>

OM group FCDRTMP2 (continued)

Register name (acronym)	Register name (expanded)	Information
TMPLT_56	Template 56	<p><i>Description:</i></p> <p>Counts the number of times the template at index 56 is used to format a CDR</p> <p><i>Associated registers:</i> None</p> <p><i>EXT registers:</i> FCDRTM2E</p> <p><i>Register validation:</i> None</p> <p><i>Associated logs:</i> None</p>
TMPLT_57	Template 57	<p><i>Description:</i></p> <p>Counts the number of times the template at index 57 is used to format a CDR</p> <p><i>Associated registers:</i> None</p> <p><i>EXT registers:</i> FCDRTM2E</p> <p><i>Register validation:</i> None</p> <p><i>Associated logs:</i> None</p>
TMPLT_58	Template 58	<p><i>Description:</i></p> <p>Counts the number of times the template at index 58 is used to format a CDR</p> <p><i>Associated registers:</i> None</p> <p><i>EXT registers:</i> FCDRTM2E</p> <p><i>Register validation:</i> None</p> <p><i>Associated logs:</i> None</p>
TMPLT_59	Template 59	<p><i>Description:</i></p> <p>Counts the number of times the template at index 59 is used to format a CDR</p> <p><i>Associated registers:</i> None</p> <p><i>EXT registers:</i> FCDRTM2E</p> <p><i>Register validation:</i> None</p> <p><i>Associated logs:</i> None</p>

OM group FCDRTMP2 (end)

Register name (acronym)	Register name (expanded)	Information
TMPLT_60	Template 60	<p><i>Description:</i></p> <p>Counts the number of times the template at index 60 is used to format a CDR</p> <p><i>Associated registers:</i> None</p> <p><i>EXT registers:</i> FCDRTM2E</p> <p><i>Register validation:</i> None</p> <p><i>Associated logs:</i> None</p>
TMPLT_61	Template 61	<p><i>Description:</i></p> <p>Counts the number of times the template at index 61 is used to format a CDR</p> <p><i>Associated registers:</i> None</p> <p><i>EXT registers:</i> FCDRTM2E</p> <p><i>Register validation:</i> None</p> <p><i>Associated logs:</i> None</p>
TMPLT_62	Template 62	<p><i>Description:</i></p> <p>Counts the number of times the template at index 62 is used to format a CDR</p> <p><i>Associated registers:</i> None</p> <p><i>EXT registers:</i> FCDRTM2E</p> <p><i>Register validation:</i> None</p> <p><i>Associated logs:</i> None</p>
TMPLT_63	Template 63	<p><i>Description:</i></p> <p>Counts the number of times the template at index 62 is used to format a CDR</p> <p><i>Associated registers:</i> None</p> <p><i>EXT registers:</i> FCDRTM2E</p> <p><i>Register validation:</i> None</p> <p><i>Associated logs:</i> None</p>

Associated logs

None

OM group FLEXDIAL

OM description

The FLEXDIAL OM group combines a set of user definable OM tuples that assist operating company personnel in measuring the frequency of dialplan usage.

The OM collectable, inside table FLEXDIAL, supports 1024 tuples capable of counting up to 2,147,483,647 before resetting to zero. This tuple is also deleted when no other OM collectable references it. The tuples defined, at datafill time, increment the counter when encountered during call processing. All tuples are in the same OM group, FLEXDIAL. Each tuple has two registers which are 16 bit counters - OM_LSIG and OM_MSIG. These two registers together represent a 32 bit integer with OM_MSIG being the most significant 16 bit counter and OM_MLSIG being the least significant 16 bit counters.

Release history

OM group FLEXDIAL was introduced in UCS07.

Registers

The following OM group FLEXDIAL registers display on the MAP terminal as follows:

```
KEY (FLEXDIAL_OM_KEY)
INFO (FLEXDIAL_OM_COUNT)
OM_SMSIG OM_LSIG
```

Group structure

OM group FLEXDIAL consists of 1024 tuples

Key field:

16 character string range definable by operating company personnel.

Info field:

One incrementable, 32 bit register counter, whenever the respective OM collectable executes.

Associated OM groups

None

OM group FLEXDIAL (end)

Register COUNTER

Register COUNTER is incremented whenever the respective OM tuple is executed within table FLEXDIAL.

Register COUNTER release history

Register COUNTER was introduced in UCS07.

Associated registers

None

Associated logs

None

Extension registers

None

OM group FLEXTYPE

OM description

The FLEXTYPE OM group identifies a number of registers that the switch may increment using a particular subscriber number or call type, defined in table FLEXTYPE.

This group supports up to 1024 tuples. If you create a new entry in table FLEXTYPE, the switch then defines the additional tuple for the FLEXTYPE OM group. If you delete an entry in table FLEXTYPE, the switch removes the associated tuple from the OM group.

Release history

OM group FLEXTYPE is updated in UCS08 to include the VALTOT, TVALTOT, CVALTOT, LVALTOT, LVALSUCC, and LVALFAIL registers.

OM group FLEXTYPE is introduced in UCS06.

Registers

The following OM group FLEXTYPE registers display on the MAP terminal as follows:

OM group FLEXTYPE (continued)

```

>omshow flextype active

FLEXTYPE

CLASS:ACTIVE
START:2000/01/02 02:30:00 SUN;STOP:2000/01/02 02:53:05
SUN;
SLOWSAMPLES:          14; FASTSAMPLES:          139;
  KEY (FLEXTYPE_IDX_RANGE)
    VALTOT   VALSUCC   VALFAIL   VALEMPY
  TVALTOT   TVALSUCC  TVALFAIL   NOVAL
  CVALTOT   CVALSUCC  CVALFAIL   CALLTYPE
  LVALTOT   LVALSUCC  LVALFAIL
0  NIL
    0         0         0         0
    0         0         0         0
    0         0         0         77
    0         0         0
1  ANI
    180       164       16         0
    0         0         0         43
    25        25        0         0
    0         0         0
2  AUTH
    83        80        3         0
    65        62        3         0
    0         0         0         0
    0         0         0

```

Group structure

OM group FLEXTYPE consists of up to 1024 tuples.

Key field:

None

Info field:

None

Associated OM groups

None

Register VALTOT

Validation total

OM group FLEXTYPE (continued)

The switch increments register VALTOT when a subscriber number is processed and a validation attempt is performed. This register has the following relationship with other FLEXTYPE registers: $VALTOT = VALSUCC + VALFAIL + VALEMPYVALTOT + NOVAL =$ Total of subscribers numbers processed

Register VALTOT release history

Register VALTOT is introduced in UCS08.

Associated registers

None

Associated logs

None

Extension registers

None

Register VALSUCC

Validation successful

The switch increments register VALSUCC when it processes a subscriber number and successfully validates it.

Register VALSUCC release history

Register VALSUCC is introduced in UCS06.

Associated registers

None

Associated logs

None

Extension registers

None

Register VALFAIL

Validation failure

The switch increments register VALFAIL when it processes a subscriber number but fails to validate it.

OM group FLEXTYPE (continued)

Register VALFAIL release history

Register VALFAIL is introduced in UCS06.

Associated registers

None

Associated logs

None

Extension registers

None

Register VALEMPY

Value empty

The switch increments register VALEMPY when it processes a subscriber number and successfully validates it using the EMPTYIDX option.

Register VALEMPY release history

Register VALEMPY is introduced in UCS06.

Associated registers

None

Associated logs

None

Extension registers

None

Register TVALTOT

City code validation total

The switch increments register TVALTOT when a citycode validation attempt is performed for a subscriber number being processed. This register has the following relationship with other FLEXTYPE registers: $TVALTOT = TVALSUCC + TVALFAIL$

Register TVALTOT release history

Register TVALTOT is introduced in UCS08.

Associated registers

None

OM group FLEXTYPE (continued)

Associated logs

None

Extension registers

None

Register TVALSUCC

City code validation successful

The switch increments register TVALSUCC when it processes a subscriber number along with a city code validation and is successful.

Register TVALSUCC release history

Register TVALSUCC is introduced in UCS06.

Associated registers

None

Associated logs

None

Extension registers

None

Register TVALFAIL

City code validation failure

The switch increments register TVALFAIL when it processes a subscriber number along with a city code validation and is not successful.

Register TVALFAIL release history

Register TVALFAIL is introduced in UCS06.

Associated registers

None

Associated logs

None

Extension registers

None

OM group FLEXTYPE (continued)

Register NOVAL

No validation

The switch increments register NOVAL when it processes a subscriber number but does not validate it.

Register NOVAL release history

Register NOVAL was introduced in UCS06.

Associated registers

None

Associated logs

None

Extension registers

None

Register CVALTOT

Casual validation total

The switch increments register CVALTOT when a casual number blocking validation attempt is performed for a subscriber number being processed. This register has the following relationship with other FLEXTYPE register: $CVALTOT = CVALSUCC + CVALFAIL$

Register CVALTOT release history

Register CVALTOT is introduced in UCS08.

Associated registers

None

Associated logs

None

Extension registers

None

Register CVALSUCC

Casual validation successful

OM group FLEXTYPE (continued)

The switch increments register **CVALSUCC** when it processes a subscriber number along with a casual blocking validation and is successful (that is, the switch does not block the call).

Register CVALSUCC release history

Register **CVALSUCC** is introduced in UCS06.

Associated registers

None

Associated logs

None

Extension registers

None

Register CVALFAIL

Casual validation failure

The switch increments register **CVALFAIL** when it processes a subscriber number along with a casual blocking validation and is not successful (that is, the switch blocks the call).

Register CVALFAIL release history

Register **CVALFAIL** is introduced in UCS06.

Associated registers

None

Associated logs

None

Extension registers

None

Register CALLTYPE

Call type

The switch increments register **CALLTYPE** when it executes a **CALLTYPE** collectible that uses the **FLEXTYPE**.

Register CALLTYPE release history

Register **CALLTYPE** is introduced in UCS06.

OM group FLEXTYPE (continued)

Associated registers

None

Associated logs

None

Extension registers

None

Register LVALTOT

Call processing active validation total

The switch increments register LVALTOT when a call processing active validation attempt is performed for a subscriber number being processed. This register has the following relationship with other FLEXTYPE registers: $LVALTOT = LVALSUCC + LVALFAIL$

Register LVALTOT release history

Register LVALTOT is introduced in UCS08.

Associated registers

None

Associated logs

FLEX302

Extension registers

None

Register LVALSUCC

Call processing active validation successful

The switch increments register LVALSUCC when a successful call processing active validation attempt is performed.

Register LVALSUCC release history

Register LVALSUCC is introduced in UCS08.

Associated registers

None

Associated logs

FLEX302

OM group FLEXTYPE (end)

Extension registers

None

Register LVALFAIL

Call processing active validation failure

The switch increments register LVALFAIL when an unsuccessful call processing active validation attempt is performed.

Register LVALFAIL release history

Register LVALFAIL is introduced in UCS08.

Associated registers

None

Associated logs

FLEX302

Extension registers

None

OM group FPDABM

OM description

File processor dual-access buffer memory counts (FPDABM)

The OM group FPDABM counts the number of times that the dual-access buffer memory (DABM) changes state. The OM group FPDABM counts changes of state to in-service trouble (ISTB) or system busy (SYSB). These states indicate the occurrence of errors related to the DABM and if the errors are part of normal maintenance activities.

Release history

The OM group FPDABM was introduced in BCS33.

Registers

The OM group FPDABM registers appear on the MAP terminal as follows:

FPDABMIT FPDABMSB FPDABMRX

Group structure

The OM group FPDABM provides four tuples for each FP to a maximum of 100 FPs.

Key field:

FPD_SYMB_NUM

Info field:

FPDABM_OM_INFO_T

Associated OM groups

There are no associated OM groups.

Associated working groups

The working group Series Three Peripheral-File Processor associates with OM -group FPDABM.

OM group FPDABM (continued)

Associated functionality codes

The associated functionality codes for OM group FPDABM appear in the following table.

Functionality	Code
File Processor (FP)	NTXF04AA

OM group FPDABM registers

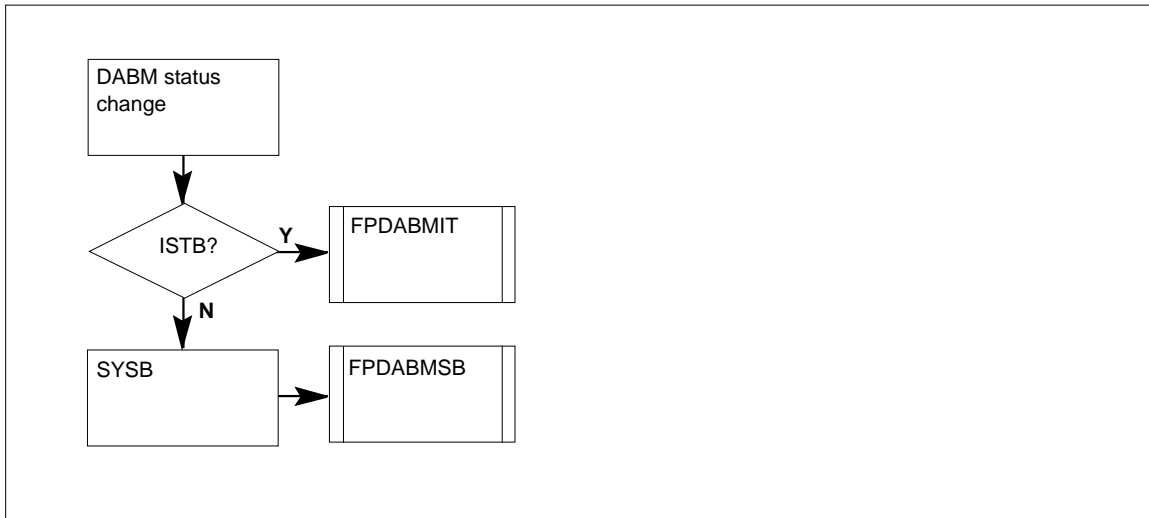

Register FPDABMIT

FP DABM in-service trouble count (FPDABMIT)

Register counts the number of times the DABM changes state to an ISTB.

Register FPDABMIT release history

Register FPDABMIT was introduced in BCS33.

Associated registers

There are no associated registers.

Associated logs

The system generates FP552 for each change in the operational status of the FP DABM.

OM group FPDABM (end)

Register FPDABMRX

FP DABM system busy, caused by a routine exercise (REX) test (FPDABMRX)

Register FPDABMRX counts the number of times the DABM changes state to SYSB as a result of an REX test.

This register is not active.

Register FPDABMRX release history

Register FPDABMRX was introduced in BCS33.

Associated registers

There are no associated registers.

Associated logs

The system generates FP552 for each change in the operational state of the FP DABM.

Register FPDABMSB

FP DABM system busy count (FPDABMSB)

Register FPDABMSB counts the number of times the DABM changes state to SYSB.

Register FPDABMSB release history

Register FPDABMSB was introduced in BCS33.

Associated registers

FPDABMRX

Associated logs

The system generates FP552 for each change in the operational state of the FP DABM.

OM group FPDEVICE

OM description

File processor storage device counts (FPDEVICE)

The OM group FPDEVICE counts the number of times each file processor (FP) storage device enters the following states:

- in-service trouble (ISTB)
- manual busy (ManB)
- not available (NA)
- resource busy (RBSY)
- system busy (SYSB)

The OM group FPDEVICE counts the number of times that use indicators specify the device activity.

Release history

The OM group FPDEVICE was introduced in BCS33.

Registers

The OM group FPDEVICE registers appear on the MAP terminal as follows:

FPDIP0EU	FPDIP1EU	FPDEVMB	FPDEVMBU
FPDEVRB	FPDEVRB	FPDEVNA	FPDEVNAU
FPDEVIT	FPDEVITU	FPDEVSB	FPDEVSB
FPDEVBW	FPDEVBR	FPDEVQR	FPDEVRA
FPDEVRRAR	FPDEVNU		

Group structure

The OM group FPDEVICE provides 12 tuples for each FP to a maximum of 100 FPs.

Key field:

FPD_SYMB_NUM

Info field:

FPDEVICE_OM_INFO_T

OM group FPDEVICE (continued)

OM group FPDEVICE registers

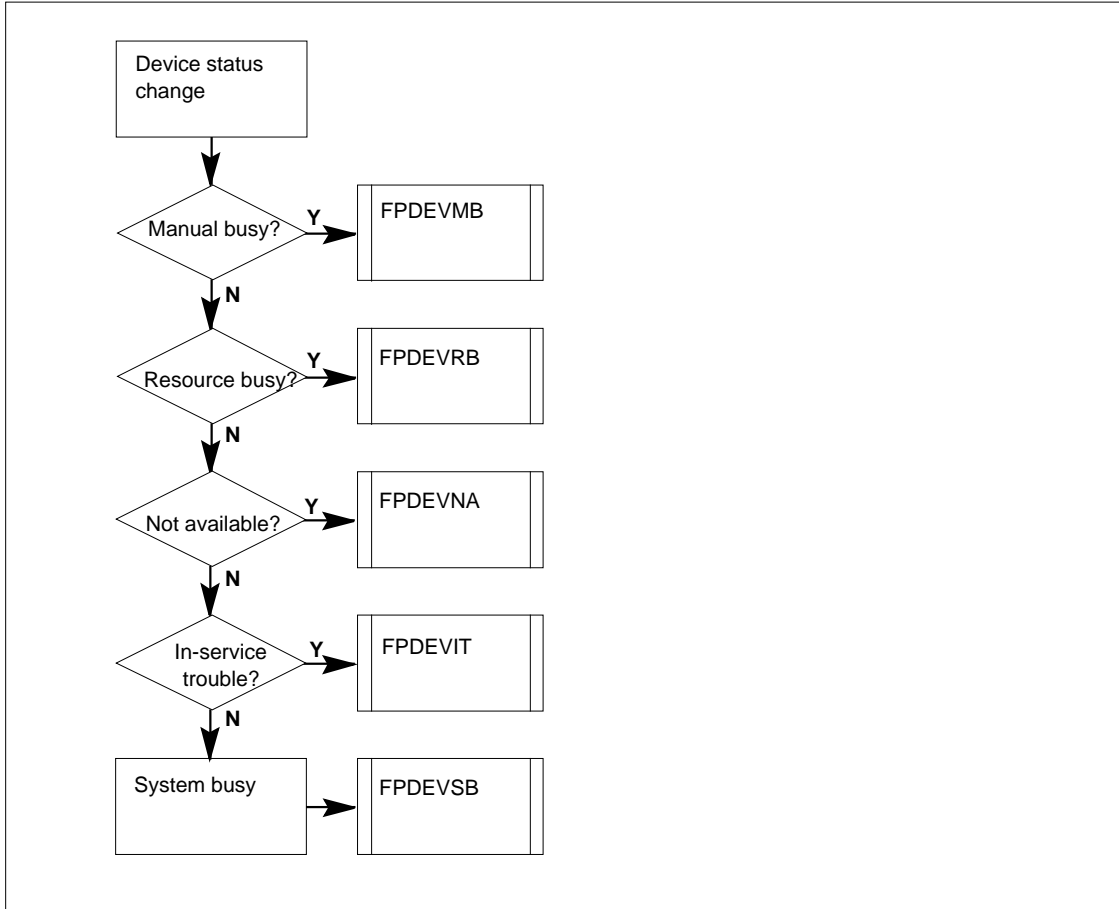

OM group FPDEVICE (continued)

OM group FPDEVICE usage registers

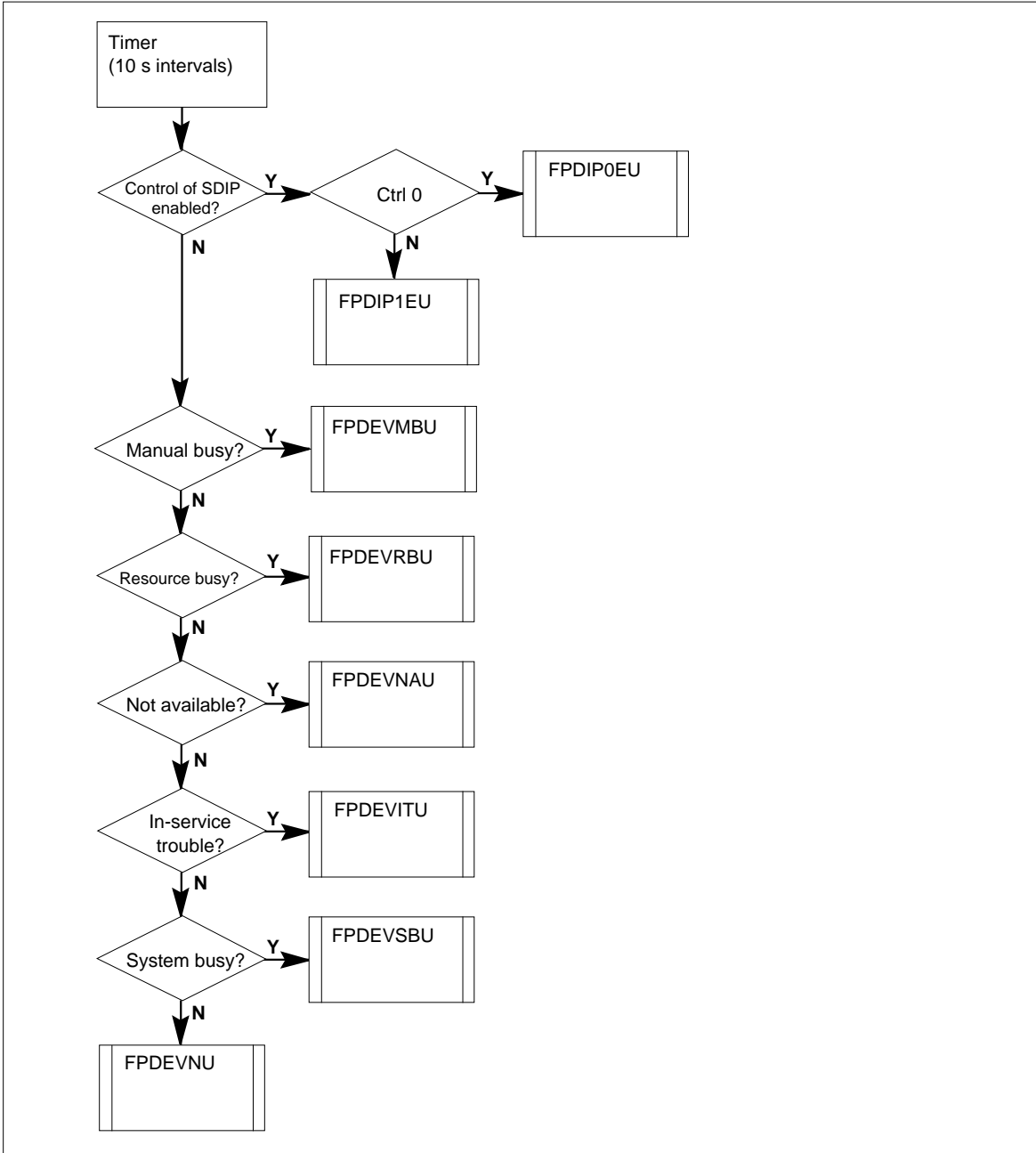

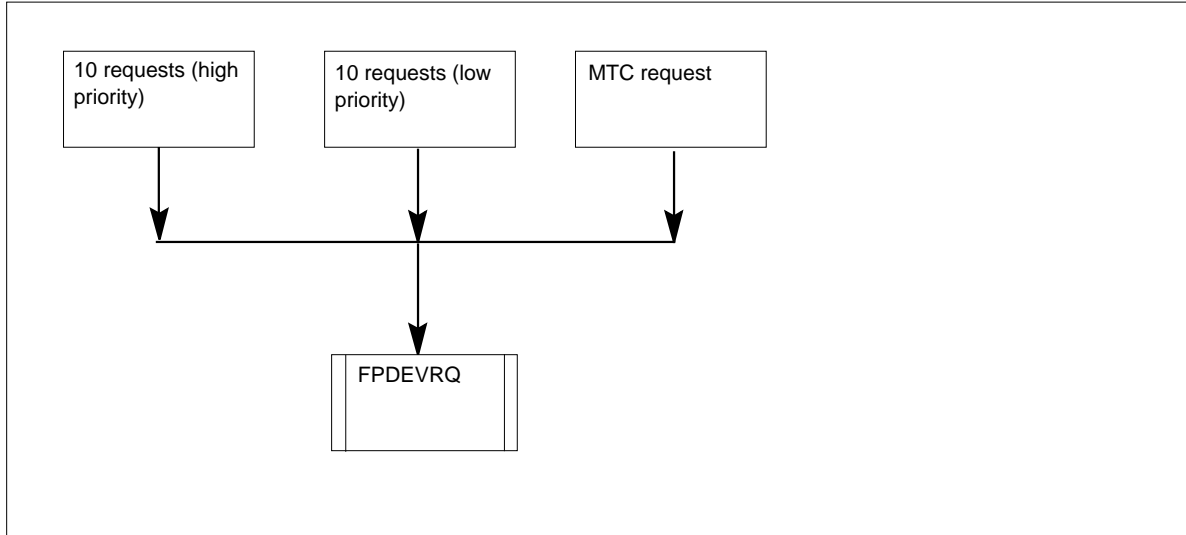
OM group FPDEVICE (continued)**OM group FPDEVICE FPDEVRQ register****Associated OM groups**

There are no associated OM groups.

Associated working groups

The working group Series Three Peripheral-File Processor associates with OM group FPDEVICE.

Associated functionality codes

The associated functionality codes for OM group FPDEVICE appear in the following table.

Functionality	Code
File Processor	NTXF04AA

Register FPDEVBR

FP storage device blocks read count (FPDEVBR)

Register FPDEVBR counts the number of blocks that the system reads from the given storage device.

This register is not active.

OM group FPDEVICE (continued)

Register FPDEVBR release history

Register FPDEVBR was introduced in BCS33.

Associated registers

FPDEVNU

Associated logs

There are no associated logs.

Register FPDEVBW

FP storage device blocks written count (FPDEVBW)

Register FPDEVBW counts the number of blocks that the system writes to the given storage device. This count takes into account the time interval during which the count accumulates to determine block write traffic.

This register is not active.

Register FPDEVBW release history

Register FPDEVBW was introduced in BCS33.

Associated registers

FPDEVNU

Associated logs

There are no associated logs.

Register FPDEVIT

FP storage device ISTB state count (FPDEVIT)

Register FPDEVIT increases each time the given storage device changes state to ISTB.

Register FPDEVIT release history

Register FPDEVIT was introduced in BCS33.

Associated registers

There are no associated registers.

Associated logs

There are no associated logs.

OM group FPDEVICE (continued)

Register FPDEVITU

FP storage device ISTB state usage (FPDEVITU)

Register FPDEVITU increases every 10 s when the given storage device is in the ISTB state.

Register FPDEVITU release history

Register FPDEVITU was introduced in BCS33.

Associated registers

FPDEVNU

Associated logs

There are no associated logs.

Register FPDEVMB

FP storage device ManB state count (FPDEVMB)

Register FPDEVMB increases each time the given storage device changes state to ManB.

Register FPDEVMB release history

Register FPDEVMB was introduced in BCS33.

Associated registers

There are no associated registers.

Associated logs

The system generates FP503 each time the operational state changes for the storage device.

Register FPDEVMBU

FP storage device ManB state usage (FPDEVMBU)

Register FPDEVMBU increases every 10 s when the given storage device is in the ManB state.

FPDEVMBU release history

Register FPDEVMBU was introduced in BCS33.

Associated registers

FPDEVNU

OM group FPDEVICE (continued)

Associated logs

There are no associated logs.

Register FPDEVNA

FP storage device NA state count (FPDEVNA)

Register FPDEVNA increases each time the given storage device changes state to NA.

Register FPDEVNA release history

Register FPDEVNA was introduced in BCS33.

Associated registers

There are no associated registers.

Associated logs

The system generates FP503 each time operational state changes for the storage device.

Register FPDEVNAU

FP storage device NA state usage (FPDEVNAU)

Register FPDEVNAU increases every 10 s when the given storage device is in the NA state.

Register FPDEVNAU release history

Register FPDEVNAU was introduced in BCS33.

Associated registers

FPDEVNU

Associated logs

There are no associated logs.

Register FPDEVNU

FP storage device number of usage intervals in the last transfer period (FPDEVNU)

Register FPDEVNU increases every 10 when the usage scan process checks usage conditions for registers in OM group FPDEVICE.

Register FPDEVNU release history

Register FPDEVNU was introduced in BCS33.

OM group FPDEVICE (continued)

Associated registers

There are no associated registers.

Associated logs

There are no associated logs.

Register FPDEVRA

FP storage device unrecoverable block assignment count (FPDEVRA)

Register FPDEVRA counts the number of unrecoverable block reassignments.

This register is not active.

Register FPDEVRA release history

Register FPDEVRA was introduced in BCS33.

Associated registers

FPDEVNU

Associated logs

There are no associated logs.

Register FPDEVRAR

FP storage device recoverable block assignment count (FPDEVRAR)

Register FPDEVRAR counts the number of recoverable block reassignments.

This register is not active.

Register FPDEVRAR release history

Register FPDEVRAR was introduced in BCS33.

Associated registers

FPDEVNU

Associated logs

There are no associated logs.

Register FPDEVRB

FP storage device RBSY state count (FPDEVRB)

Register FPDEVRB increases each time the given storage device changes state to RBSY.

OM group FPDEVICE (continued)

Register FPDEVRB release history

Register FPDEVRB was introduced in BCS33.

Associated registers

There are no associated registers.

Associated logs

The system generates FP503 each time the operational state for the storage device changes.

Register FPDEVRBU

FP storage device RBSY state usage (FPDEVRBU)

Register FPDEVRBU increases every 10 s when the given storage device is in the RBSY state.

Register FPDEVRBU release history

Register FPDEVRBU was introduced in BCS33.

Associated registers

FPDEVNU

Associated logs

There are no associated logs.

Register FPDEVRQ

FP storage device requests count (FPDEVRQ)

Register FPDEVRQ counts the number of requests to the given storage device.

Register FPDEVRQ release history

Register FPDEVRQ was introduced in BCS33.

Associated registers

FPDEVNU

Associated logs

There are no associated logs.

Register FPDEVSB

FP storage device SYSB state count (FPDEVSB)

OM group FPDEVICE (continued)

Register FPDEVSB increases each time the given storage device changes state to SYSB.

Register FPDEVSB release history

Register FPDEVSB was introduced in BCS33.

Associated registers

There are no associated registers.

Associated logs

The system generates FP503 each time the operational state for the storage device changes.

Register FPDEVSBU

FP storage device SYSB state usage (FPDEVSBU)

Register FPDEVSBU increases every 10 s when the given storage device is in the SYSB state.

Register FPDEVSBU release history

Register FPDEVSBU was introduced in BCS33.

Associated registers

FPDEVNU

Associated logs

There are no associated logs.

Register FPDIP0EU

FP device interface paddleboard for controller 0, enabled usage (FPDIP0EU)

Register FPDIP0EU increases every 10 s when the given SCSI device interface paddleboard (SDIP) on controller 0 is enabled.

Register FPDIP0EU release history

Register FPDIP0EU was introduced in BCS33.

Associated registers

FPDEVNU

Associated logs

There are no associated logs.

OM group FPDEVICE (end)

Register FPDIP1EU

FP device interface paddleboard for controller 1, enabled usage (FPDIP1EU)

The FPDIP1EU increases every 10 s when the given SCSI device interface paddleboard (SDIP) on controller 1 is enabled.

Register FPDIP1EU release history

The BCS33 introduced FPDIP1EU.

Associated registers

FPDEVNU

Associated logs

There are no associated logs.

OM group FPSCSI

OM description

FP SCSI bus counts (FPSCSI)

The OM group FPSCSI counts the number of times the SCSI changes state. This OM group also provides an indication of bus activity.

Release history

The OM group FPSCSI was introduced in BCS33.

Registers

The OM group FPSCSI registers appear on the MAP terminal as follows:

FPSCSIMB	FPSCSIRB	FPSCSIIT	FPSCSISB
FPSCSIRX	FPSCSIEU	FPSIPPIO	FPSIPPMO
FPSIPPDO	FPSCSISW	FPSCSIRS	FPSCSIIU
FPSCSINU			

Group structure

The OM group FPSCSI provides four tuples for each FP to a maximum of 100 FPs.

Key field:

FPD_SYMB_NUM

Info field:

FPSCSI_OM_INFO_T

Associated OM groups

There are no associated OM groups.

Associated working groups

The working group Series Three Peripheral-File Processor associates with OM group FPSCSI.

OM group FPSCSI (continued)

Associated functionality codes

The associated functionality codes for OM group FPSCSI appear in the following table.

Functionality	Code
File Processor (FP)	NTXF04AA

OM group FPSCSI registers

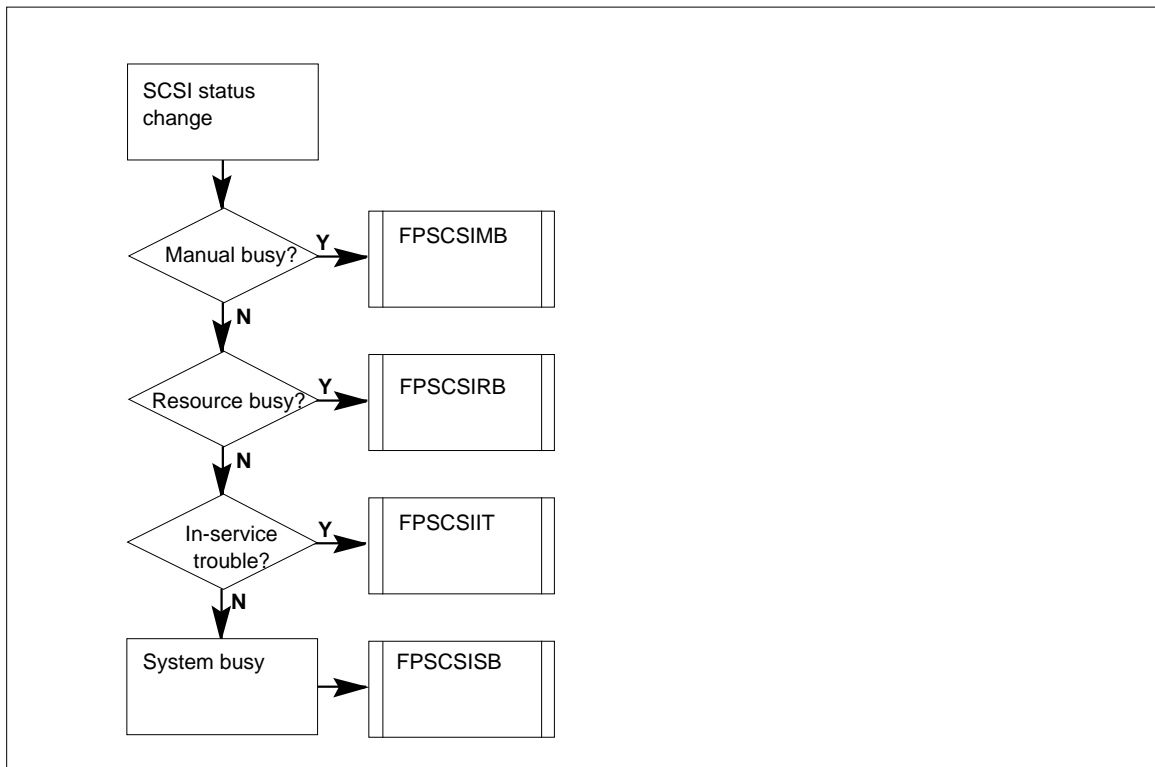

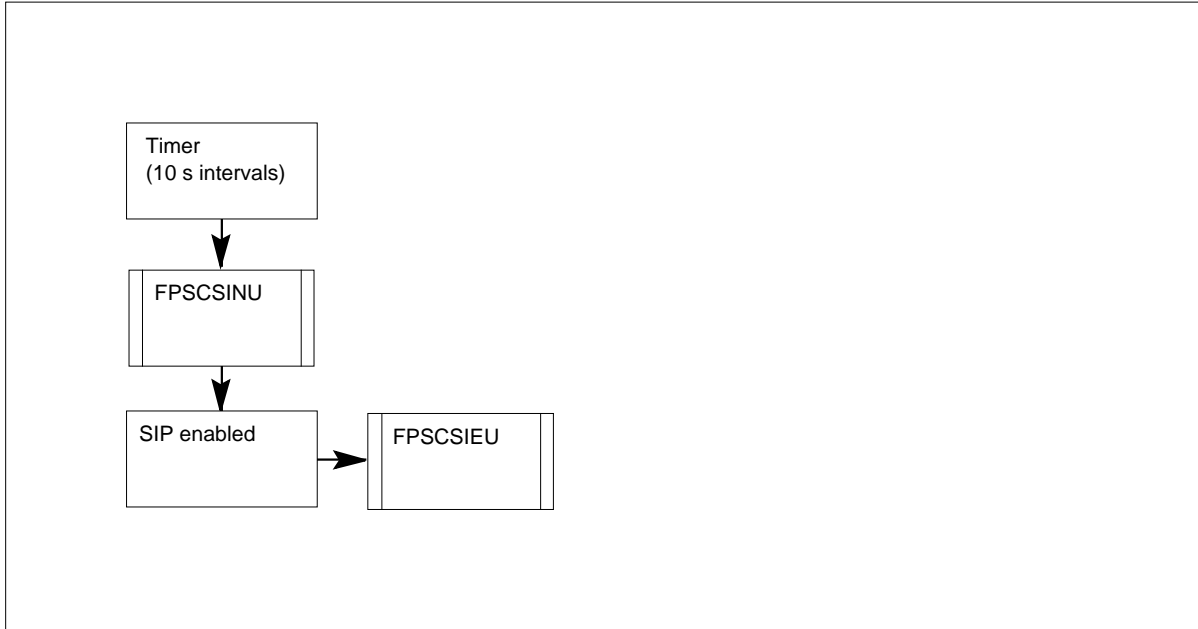
OM group FPSCSI (continued)**OM group FPSCSI usage registers****Register FPSCSIEU**

FP SCSI bus enabled usage (FPSCSIEU)

Register FPSCSIEU increases every 10 s when the SCSI bus is enabled.

Register FPSCSIEU release history

Register FPSCSIEU was introduced in BCS33.

Associated registers

FPSCSINU

Associated logs

The system generates FP504 when the operational state of the SCSI bus changes.

Register FPSCSIIT

FP SCSI bus ISTB count (FPSCSIIT)

Register FPSCSIIT increases when the SCSI bus changes state to in-service trouble (ISTB).

Register FPSCSIIT release history

Register FPSCSIIT was introduced in BCS33.

OM group FPSCSI (continued)

Associated registers

There are no associated registers.

Associated logs

The system generates FP504 when the operational state of the SCSI bus changes.

Register FPSCSIU

FP SCSI bus device usage (FPSCSIU)

Register FPSCSIU increases every 10 s when a storage device uses the SCSI.

This register is not active.

FPSCSIU release history

Register FPSCSIU was introduced in BCS33.

Associated registers

FPSCSINU

Associated logs

There are no associated logs.

Register FPSCSIMB

FP SCSI bus ManB count (FPSCSIMB)

Register FPSCSIMB increases when the SCSI bus changes state to manual busy (ManB).

Register FPSCSIMB release history

Register FPSCSIMB was introduced in BCS33.

Associated registers

There are no associated registers.

Associated logs

The system generates FP504 when the operational state of the SCSI bus changes.

Register FPSCSINU

FP SCSI bus number of usage intervals in the last transfer period (FPSCSINU)

OM group FPSCSI (continued)

Register FPSCSINU increases every 10 s when the usage scan process checks usage conditions for registers in OM group FPSCSI.

Register FPSCSINU release history

Register FPSCSINU was introduced in BCS33.

Associated registers

There are no associated registers.

Associated logs

There are no associated logs.

Register FPSCSIRB

FP SCSI bus RBSY count (FPSCSIRB)

Register FPSCSIRB increases when the SCSI bus changes state to resource busy (RBSY).

Register FPSCSIRB release history

Register FPSCSIRB was introduced in BCS33.

Associated registers

There are no associated registers.

Associated logs

The system generates FP504 when the operational state of the SCSI bus changes.

Register FPSCSIRS

FP SCSI bus SWEN caused by a REx test (FPSCSIRS)

Register FPSCSIRS counts the number of times the SCSI bus changes state to switch enable (SWEN). The SCSI bus changes state to SWEN to switch from one bus to the other because of a routine exercise (REx) test.

This register is not active.

Register FPSCSIRS release history

Register FPSCSIRS was introduced in BCS33.

Associated registers

There are no associated registers.

OM group FPSCSI (continued)

Associated logs

The system generates FP504 when the operational state of the SCSI bus changes.

Register FPSCSIRX

FP SCSI bus SYSB caused by an REx (FPSCSIRX)

Register FPSCSIRX increases when the SCSI bus changes state to SYSB as a result of a REx test.

This register is not active.

Register FPSCSIRX release history

Register FPSCSIRX was introduced in BCS33.

Associated registers

There are no associated registers.

Associated logs

The system generates FP504 when the operational state of the SCSI bus changes.

Register FPSCSISB

FP SCSI bus SYSB count (FPSCSISB)

Register FPSCSISB increases when the SCSI bus changes state to the system busy (SYSB).

Register FPSCSISB release history

Register FPSCSISB was introduced in BCS33.

Associated registers

FPSCSIRX

Associated logs

The system generates FP504 when the operational state of the SCSI bus changes.

Register FPSCSISW

FP SCSI bus SWEN count (FPSCSISW)

OM group FPSCSI (continued)

Register FPSCSISW counts the number of times the SCSI bus changes state to switch enable (SWEN). The SCSI bus changes state to SWEN to switch from one bus to the other.

This register is not active.

Register FPSCSISW release history

Register FPSCSISW was introduced in BCS33.

Associated registers

FPSCSIRS

Associated logs

The system generates FP504 when the operational state of the SCSI bus changes.

Register FPSIPPDO

FP SCSI paddleboard processor storage device access occupancy (FPSIPPDO)

Register FPSIPPDO counts the amount of time that the SCSI processor performs device access activity. The register counts the amount in a percentage value. This value increases to the next percentage every 10 s. The device access processor occupancy represents the amount of time the processor does not perform maintenance activity and is not idle.

This register is not active.

Register FPSIPPDO release history

Register FPSIPPDO was introduced in BCS33.

Associated registers

FPSIPPPIO, FPSIPPMO, FPSCSINU

Associated logs

The system generates FP504 when the operational state of the SCSI bus changes.

Register FPSIPPIO

FP SCSI paddleboard processor idle occupancy (FPSIPPIO)

OM group FPSCSI (end)

Register FPSIPPIO counts the amount of time the SCSI processor is idle. The register counts the amount of time in a percentage value. This value increases to the next percentage value every 10 s.

This register is not active.

Register FPSIPPIO release history

Register FPSIPPIO was increased in BCS33.

Associated registers

FPSIPPMO, FPSIPPDO, FPSCSINU

Associated logs

The system generates FP504 when the operational state of the SCSI bus changes.

Register FPSIPPMO

FP SCSI paddleboard processor maintenance occupancy (FPSIPPMO)

Register FPSIPPMO counts the amount of time the SCSI processor performs maintenance activity. The register counts the amount of time in a percentage value. This value increases to the next percentage value every 10 s.

This register is not active.

Register FPSIPPMO release history

Register FPSIPPMO was introduced in BCS33.

Associated registers

FPSIPPIO, FPSIPPDO, FPSCSINU

Associated logs

The system generates FP504 when the operational state of the SCSI bus changes.

OM group FTAM

OM Description

File transfer access and management (FTAM)

The FTAM provides operational measurements (OM) for file transfer, access and management activities that occur in the billing server open system interface (OSI) protocol stack.

Release history

The OM group FTAM was introduced in BCS34.

Registers

The OM group FTAM registers appears on the MAP terminal as follows:

FASSOK	FASSOK2	FASSFL	FASSFL2
FDIRINF	FDIRINF2	FFILOK	FFILOK2
FKBOK	FKBOK2	FRQDEL	FRQDEL2
FRESTS	FRESTS2	FRESTF	FRESTF2
FRECAF	FRECAF2	FRECAF	FRECAF2

Group structure

The OM group FTAM provides one tuple for each office.

Key field:

There is no key field.

Info field:

NCMNODE_INFO

Associated OM groups

There are no associated OM groups.

Associated functional groups

There are no functional groups.

OM group FTAM (continued)

Associated functionality codes

The functionality codes associated with OM group FTAM appear in the following table.

Functionality	Code
OSI File Transfer Protocol—FTAM	NTXP23AA01

OM group FTAM registers

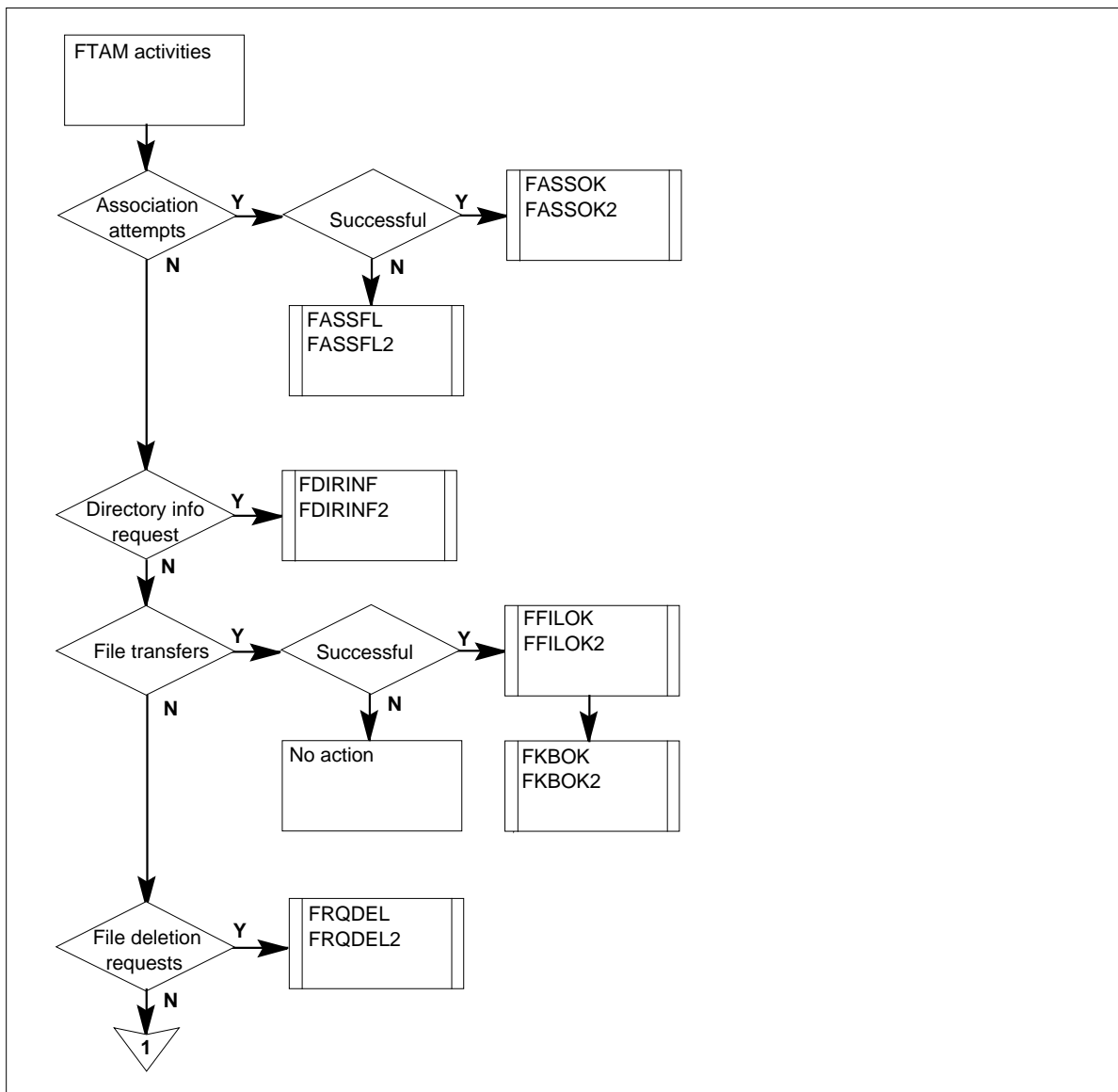

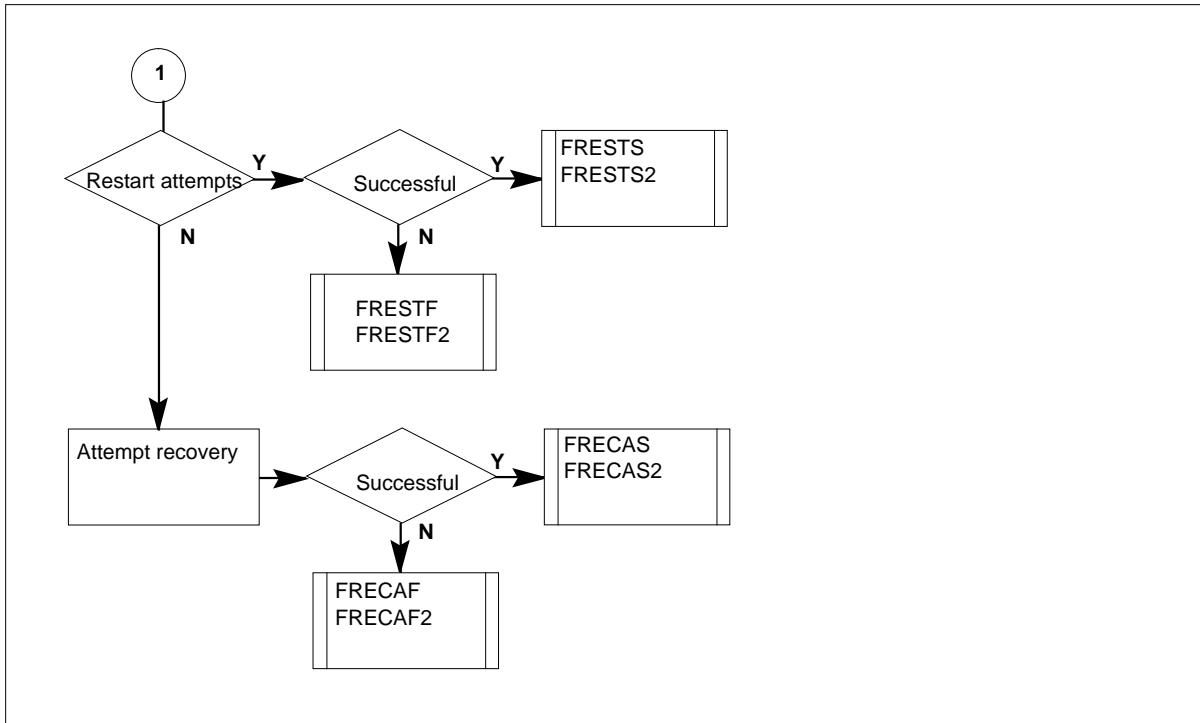
OM group FTAM (continued)**OM group FTAM registers (end)****Register FASSFL**

FTAM association failed (FASSFL)

Register FASSFL increases after each FTAM association attempt failure.

FASSFL release history

Register FASSFL was introduced in BCS34.

Associated registers

There are no associated registers.

Associated logs

There are no associated logs.

Extension registers

Register FASSFL2

OM group FTAM (continued)

Register FASSOK

FTAM association successful (FASSOK)

Register FASSOK increases each time an FTAM association attempt succeeds.

FASSOK release history

Register FASSOK was introduced in BCS34.

Associated registers

There are no associated registers.

Associated logs

There are no associated logs.

Extension registers

Register FASSOK2

Register FDIRINF

Register FTAM directory information request (FDIRINF)

Register FDIRINF increases each time the FTAM receives a request for directory information.

FDIRINF release history

Register FDIRINF was introduced in BCS34.

Associated registers

There are no associated registers.

Associated logs

There are no associated logs.

Extension registers

Register FDIRINF2

Register FFILOK

FTAM files successful (FFILOK)

Register FFILOK increases each time the FTAM transfers a file correctly from the DMS to a remote station.

FFILOK release history

Register FFILOK was introduced in BCS34.

OM group FTAM (continued)

Associated registers

There are no associated registers.

Associated logs

There are no associated logs.

Extension registers

Register FFILOK2

Register FKBOOK

FTAM Kbytes successful (FKBOOK)

Register FKBOOK records the number of Kbytes of data that the FTAM transfers correctly from the DMS to a remote station.

FKBOOK release history

Register FKBOOK was introduced in BCS34.

Associated registers

There are no associated registers.

Associated logs

There are no associated logs.

Extension registers

Register FKBOOK2

Register FRECAF

FTAM recovery attempt failed (FRECAF)

Register FRECAF increases after each FTAM recovery attempt failure.

FRECAF release history

Register FRECAF was introduced in BCS34.

Associated registers

There are no associated registers.

Associated logs

There are no associated logs.

Extension registers

Register FRECAF2

OM group FTAM (continued)

Register FRECAS

FTAM recovery attempt successful (FRECAS)

Register FRECAS increases after each successful FTAM recovery.

FRECAS release history

Register FRECAS was introduced in BCS34.

Associated registers

There are no associated registers.

Associated logs

There are no associated logs.

Extension registers

Register FRECAS2

Register FRESTF

FTAM restart failed (FRESTF)

Register FRESTF increases after each FTAM restart failure.

FRESTF release history

Register FRESTF was introduced in BCS34.

Associated registers

There are no associated registers.

Associated logs

There are no associated logs.

Extension registers

Register FRESTF2

Register FRESTS

FTAM restart successful (FRESTS)

Register FRESTS increases each time the FTAM performs a successful restart.

FRESTS release history

Register FRESTS was introduced in BCS34.

OM group FTAM (end)

Associated registers

There are no associated registers.

Associated logs

There are no associated logs.

Extension Registers

Register FRESTS2

Register FRQDEL

Files requested for deletion (FRQDEL)

Register FRQDEL increases each time the FTAM handles a request to delete a file.

FRQDEL release history

Register FRQDEL was introduced in BCS34.

Associated registers

There are no associated registers.

Associated logs

There are no associated logs.

Extension registers

Register FRQDEL2

OM group FTROM

OM description

Feature data block OM

AIN OMs for Telco Engineering (AU2731), introduces OM group FTROM. OM group FTROM provides information to assist in switch resource engineering. It is recommended that this OM group be used only for this purpose.

Release history

OM group FTROM is introduced in NA009.

Registers

The following OM group FTROM registers display on the MAP terminal as follows:

```
FTROM

CLASS:    ACTIVE
START:1998/01/14 13:00:00 WED; STOP: 1998/01/14 13:04:59
WED;
SLOWSAMPLES:          3 ; FASTSAMPLES:          30 ;

          KEY (FTR_NAME)
          INFO (FTR_DATA_SIZES_INFO)
          FTRHI    FTRSEIZ  FTRSEIZ2
```

Group structure

OM group FTROM

Key field:

FTR_NAME

Info field:

SMALL, MEDIUM, LARGE, X_LARGE, or CRITICAL.

Associated OM groups

OM group EXT

Associated functional groups

None

Associated functionality codes

None

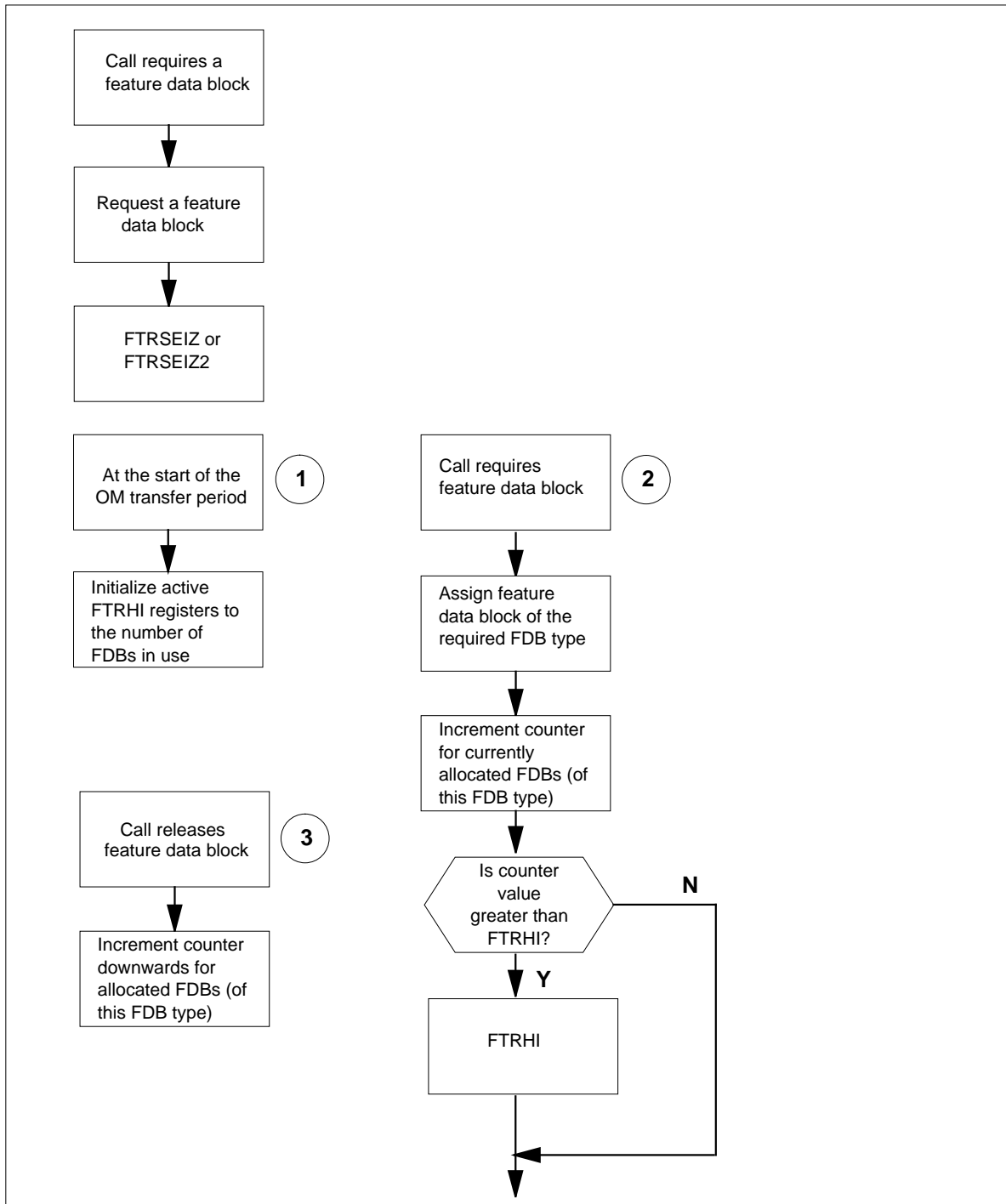
OM group FTROM (continued)**OM group FTROM registers**

OM group FTROM (continued)

Register FTRHI

Register maximum number of FDBs in simultaneous use

Register FTRHI records the maximum number of simultaneously allocated FDBs of a specific type, during an OM transfer period.

Register FTRHI release history

Register FTRHI is introduced in NA009.

Associated registers

EXTHI

Associated logs

None

Extension registers

None

Validation formula

None

Register FTRSEIZ

Register number of successful FDB allocations

Register FTRSEIZ records the number of successfully allocated FDBs of a specific type, during an OM transfer period.

Register FTRSEIZ release history

Register FTRSEIZ is introduced in NA009.

Associated registers

EXTSEIZ, EXTSEIZ2

Associated logs

None

Extension registers

FTRSEIZ2

Validation formula

Total of all tuples with info field SMALL = EXTSEIZ for tuple
SMALL_FEATURE_DATA

OM group FTROM (end)

Total of all tuples with info field MEDIUM = EXTSEIZ for tuple
MEDIUM_FEATURE_DATA

Total of all tuples with info field LARGE = EXTSEIZ for tuple
LARGE_FEATURE_DATA

Total of all tuples with infor field X_LARGE =EXTSEIZ for tuple
X_LARGE_FEATURE_DATA

Total of all tuples with info field CRITICAL = EXTSEIZ for tuple
CRITICAL_FEATURE_DATA

OM group FTRQ

OM description

Feature queue software resources.

FTRQ counts the number of successful and unsuccessful requests for feature queue blocks made in an OM transfer period. The high-water mark (register FTRQHI) records the maximum number of feature queue blocks to date that were in simultaneous use during a transfer period.

The data supplied by FTRQ is used to monitor the number of feature queue blocks used in an office and provides a measurement of the number of FTRQ features being used at a given time.

Release history

BASE 08

Extension registers, FTRQHI2, FTRQSZ2 and FTRQOFL2, were added to registers FTRQHI, FTRQSEIZ and FTRQOVFL. Registers FTRQHI, FTRQSEIZ and FTRQOVFL do not change in functionality, but now work together with their extension registers to provide higher FTRQ feature measurement capacity.

BASE07

The following FTRQ office parameters in table OFCENG were eliminated and replaced by FTRQ pools in office parameter DYNAMIC_MEMORY_SIZE: FTRQAGENTS, FTRQ0WAREAS, FTRQ2WAREAS, FTRQ4WAREAS, FTRQ8WAREAS, FTRQ16WAREAS, FTRQ32WAREAS, FTRQ0WPERMS, FTRQ2WPERMS, FTRQ4WPERMS, FTRQ8WPERMS, FTRQ16WPERMS, and FTRQ32WPERMS.

BCS30

Feature queue blocks FTRQ32WAREAS and FTRQ32WPERMS were added to key field.

BCS29

Feature queue blocks FTRQ0WPERMS, FTRQ2WPERMS, FTRQ4WPERMS, FTRQ8WPERMS, and FTRQ16WPERMS were added to the key field.

BCS25

Register FTRQUSGE was deleted.

BCS23

Register FTRQUSGE was zeroed. Register FTRQHI was added.

OM group FTRQ (continued)**BCS20**

OM group FTRQ was introduced.

Registers

OM group FTRQ registers are displayed on the MAP terminal as follows:

```
FTRQSEIZ FTRQSZ2 FTRQOVFL FTRQOFL2 FTRQHI FTRQHI2
```

Group structure

OM group FTRQ provides one tuple for each key field value.

Key field:

FTRQOM_TUPLE_KEY is the type of feature queue block. The possible types of feature queue blocks are FTRQAGENTS, FTRQ0WAREAS, FTRQ2WAREAS, FTRQ4WAREAS, FTRQ8WAREAS, FTRQ16WAREAS, FTRQ32WAREAS, FTRQ0WPERMS, FTRQ2WPERMS, FTRQ4WPERMS, FTRQ8WPERMS, FTRQ16WPERMS, FTRQ32WPERMS and FTRQTIMERS.

Info field:

FTRQOM_INFO is the number of feature queue blocks of one type that are allocated. With the availability of dynamic memory the required number of each type of FTRQ blocks are dynamically allocated and provisioned by office parameter DYNAMIC_MEMORY_SIZE.

The following pools in table OFCENG parameter DYNAMIC_MEMORY_SIZE define the number of feature queue blocks for each block type: FTRQAGENTS, FTRQ0WAREAS, FTRQ2WAREAS, FTRQ4WAREAS, FTRQ8WAREAS, FTRQ16WAREAS, FTRQ32WAREAS, FTRQ0WPERMS, FTRQ2WPERMS, FTRQ4WPERMS, FTRQ8WPERMS, FTRQ16WPERMS, and FTRQ32WPERMS.

Associated OM groups

CP2 records the use of extended call control blocks (ECCB). CP2 also contains the high-water OMs for call-processing software resources.

EXT records the use of extension blocks. EXT also contains the high-water OMs for extension block software resources.

OM group FTRQ (continued)

Associated functional groups

The following functional groups are associated with OM group FTRQ:

- DMS-100 Local
- DMS-100 International
- DMS-250 Toll/Tandem
- DMS-300 Gateway
- DMS-MTX Mobile Telephone Exchange
- Meridian SL-100 PBX
- Datapath
- CCS7 Trunk Signaling

Associated functionality codes

The functionality codes associated with OM group FTRQ are shown in the following table.

Functionality	Code
Common Basic	NTX001AA
Integrated Business Networks—Basic (IBN)	NTX100AA
Network Message Service	NTXA68AA
ISUP/PRA to SMDI Interworking	NTXN34AA

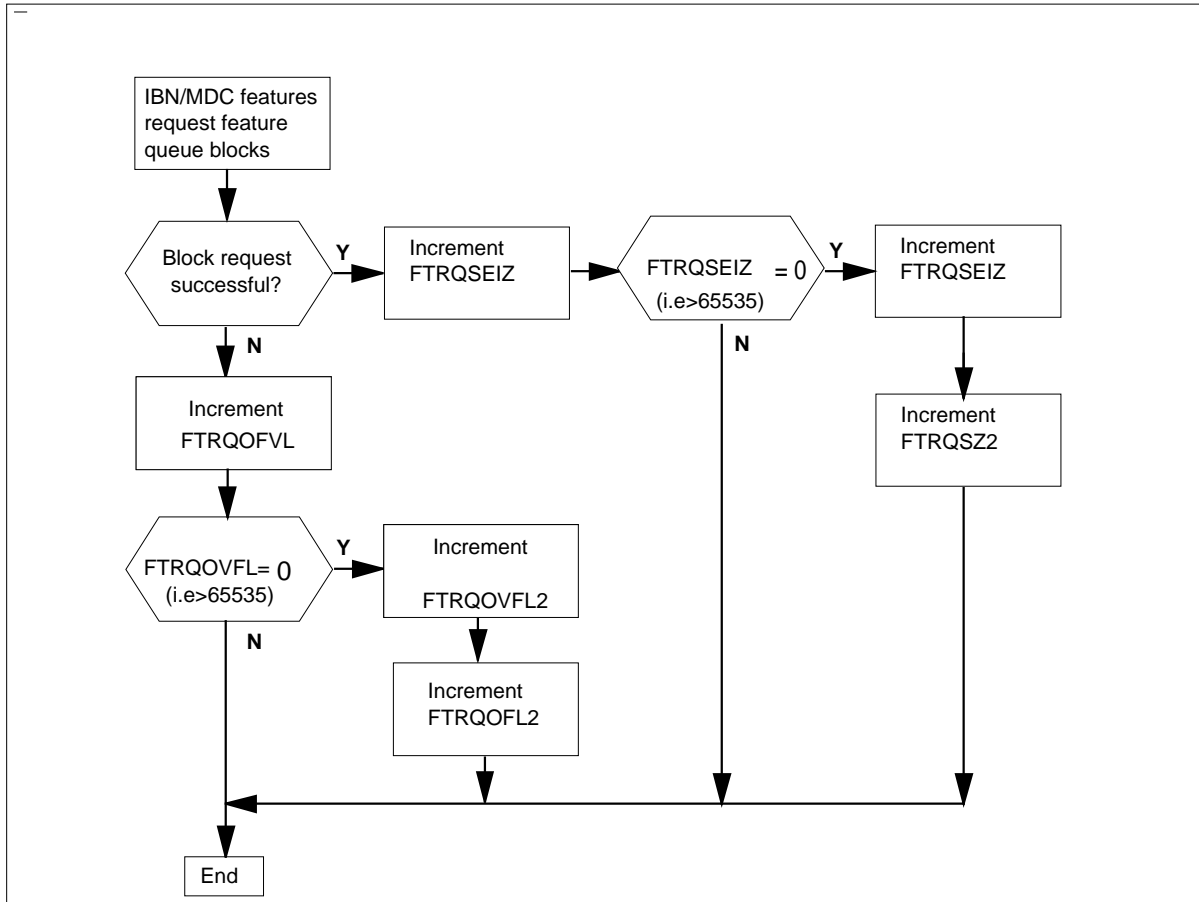
OM group FTRQ (continued)**OM group FTRQ registers**

OM group FTRQ (continued)

OM group FTRQ high-water mark

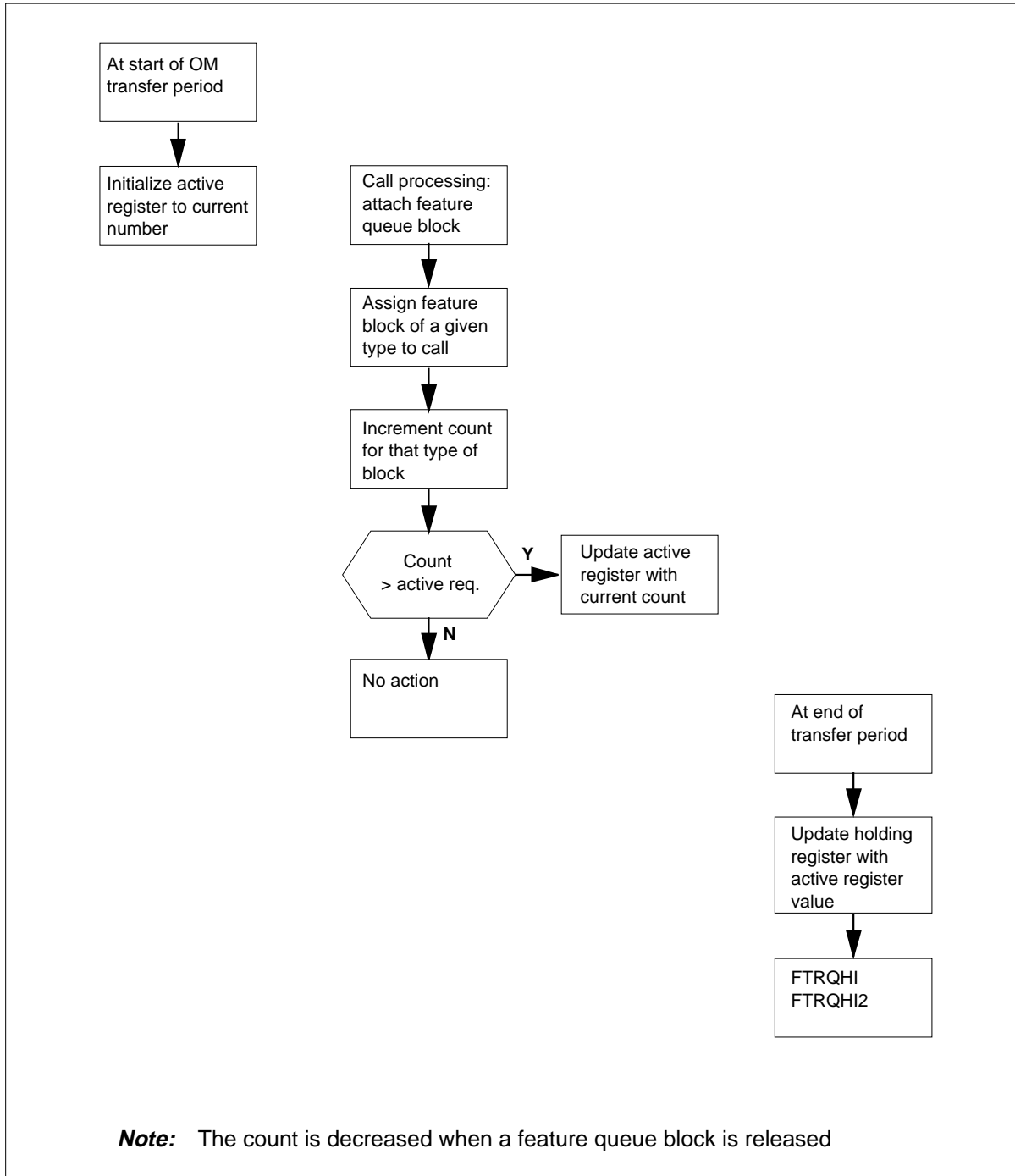

Register FTRQHI

Counts the feature queue high-water mark.

OM group FTRQ (continued)

Register FTRQHI indicates the High Water Mark value for the highest number of successful FTRQ block requests made during a transfer period to date. When register FTRQHI peg count exceeds 65535 the register is reset to zero and extension register FTRQHI2 is incremented.

Register FTRQHI release history

Register FTRQHI was introduced in BCS23.

Register FTRQHI was updated to employ extension register FTRQHI2 in release TL07.

Associated registers

Register FTRQHI2.

Associated logs

None.

Register FTRQHI2

Feature queue high-water mark extension register.

Register FTRQHI indicates the High Water Mark value for the highest number of successful FTRQ block requests made during an OM transfer period to date. When register FTRQHI peg count exceeds 65535 the register is reset to zero and extension register FTRQHI2 is incremented. Register FTRQHI in conjunction with extension register FTRQHI2 provides the total High Water Mark count.

Register FTRQHI2 release history

Register FTRQHI2 was introduced in TL07.

Associated registers

Register FTRQHI.

Associated logs

None.

Register FTRQOVFL

Counts the number of unsuccessful FTRQ block requests made during an OM transfer period.

FTRQOVFL counts the number of unsuccessful FTRQ block requests made during a transfer period. When register FTRQOVFL peg count exceeds 65535 it wraps back to zero and increments extension register FTRQOFL2. Register

OM group FTRQ (continued)

FTRQOVFL and its extension register FTRQOFL2 provide the total count of unsuccessful requests for FTRQ blocks made in a transfer period.

Register FTRQOVFL release history

Register FTRQOVFL was introduced in BCS20.

Register FTRQOVFL was updated to employ extension register FTRQOFL2 in release TL07.

Associated registers

Register FTRQOFL2

Associated logs

None.

Associated logs

None

Register FTRQOFL2

Extension register FTRQOFL2 in conjunction with register FTRQOVFL counts the total number of unsuccessful FTRQ block requests made during a transfer period.

Register FTRQOVFL counts the number of unsuccessful FTRQ block requests made during an OM transfer period. When register FTRQOVFL peg count exceeds 65535 it wraps back to zero, and increments extension register FTRQOFL2. Register FTRQOVFL and extension register FTRQOFL2 provide the total count of unsuccessful FTRQ blocks requests made in an OM transfer period.

Register FTRQOFL2 release history

Register FTRQOFL2 was introduced in release TL07.

Associated registers

Register FTRQOVFL

Associated logs

None.

Register FTRQSEIZ

Counts the number of successful FTRQ block requests.

OM group FTRQ (end)

Register FTRQSEIZ measures the number of successful FTRQ block requests during an OM transfer period. FTRQSEIZ is used in conjunction with extension register FTRQSZ2 to provide the total number of successful FTRQ block requests. Each peg to FTRQSEIZ indicates one successful FTRQ block request in the current OM transfer period. FTRQSEIZ can peg up to 65535 successful FTRQ block requests before it wraps around back to zero and pegs extension register FTRQSZ2.

Register FTRQSEIZ release history

Register FTRQSEIZ was introduced in BCS20.

Register FTRQSEIZ was updated to employ extension register FTRQSZ2 in TL07.

Associated registers

Register FTRQSZ2

Associated logs

None

Register FTRQSZ2

In conjunction with register FTRQSEIZ register FTRQSZ2 counts the total number of successful FTRQ block requests.

Register FTRQSEIZ counts the number of successful FTRQ block requests made during a transfer period. When this count exceeds 65535 register FTRQSEIZ wraps back to zero and extension register FTRQSZ2 is pegged.

Register FTRQSZ2 release history

Register FTRQSZ2 was introduced in TL07.

Associated registers

Register FTRQSEIZ.

Associated logs

None.

OM group HDBOM

OM description

The OM group History Data Block tracks the seizures for history data blocks (HDBs).

Note: This OM group was introduced in NA009, but is dormant.

Release history

OM group HDBOM was introduced in NA009.

Registers

The following OM group HDBOM registers display on the MAP terminal as follows:

```
HDBOM

CLASS:    ACTIVE
START:1998/08/04 08:30:00 TUE; STOP: 1998/08/04 08:56:02
TUE;
SLOWSAMPLES:      16 ; FASTSAMPLES:      156 ;

      KEY (HIS_FEAT_NAME)
      INFO (HDB_DATA_SIZES_INFO)
      HDBSEIZ  HDBSEIZ2
```

Note: The MAP display will show the OM group and register names, but no register values. The values are not displayed because this OM group is dormant.

Group structure

OM group HDBOM

Key field:

HDB_type

Info field:

Contains the size of the block of each HDB type.

OM group HDBOM (end)

Associated OM groups

None

Associated functional groups

None

Associated functionality codes

None

Register HDBSEIZ

Register number of successful HDB allocations

Register HDBSEIZ release history

Register HDBSEIZ was introduced in NA009.

Associated registers

None

Associated logs

None

Extension registers

HDBSEIZ2

OM group IOC

OM description

Input/output controller maintenance summary (IOC)

The OM group IOC provides information about the performance of input/output controllers (IOC). Each IOC is an interface between a maximum of 36 input/output devices and the central message controller (CMC).

Three peg registers count:

- errors and faults in the IOCs
- device errors the system detects on P-side links

Four usage registers record:

- system busy links
- manually busy links
- system busy IOCs
- manually busy IOCs

The data that the IOC supplies is used to monitor the performance of the IOCs and the output devices that the IOCs support.

Release history

The OM group IOC was introduced in BCS20.

BCS33

Registers IOCLKSBU, IOCLKMBU and IOCMBU can be converted from CCS to deci-erlangs before their display. The OMSHOW command on the ACTIVE class performs the conversion.

BCS21

Software change to provide usage counts in either CCS or deci-erlangs.

Registers

The OM group IOC registers appear on the MAP terminal as follows:

IOCERR	IOCLKERR	IOCFLT	IOCLKSBU
IOCLKMBU	IOCSBU	IOCMBU	

Group structure

The OM group IOC provides one tuple for each office.

OM group IOC (continued)**Key field:**

There is no key field

Info field:

There is no info field

Associated OM groups

There are no associated OM groups.

Associated functional groups

The following functional groups associate with OM group IOC:

- DMS-100 Local
- DMS-100/200 Local/Toll
- DMS-200 Toll
- DMS-100 Meridian
- DMS-MTX
- DMS-250 Toll/Tandem
- DMS-300
- Meridian SL-100 PBX
- DMS SuperNode

Associated functionality codes

The associated functionality codes for OM group IOC appear in the following table.

Functionality	Code
OMs in Erlangs	NTX664AA
Common Basic	NTX001AA

OM group IOC (continued)

OM group IOC registers

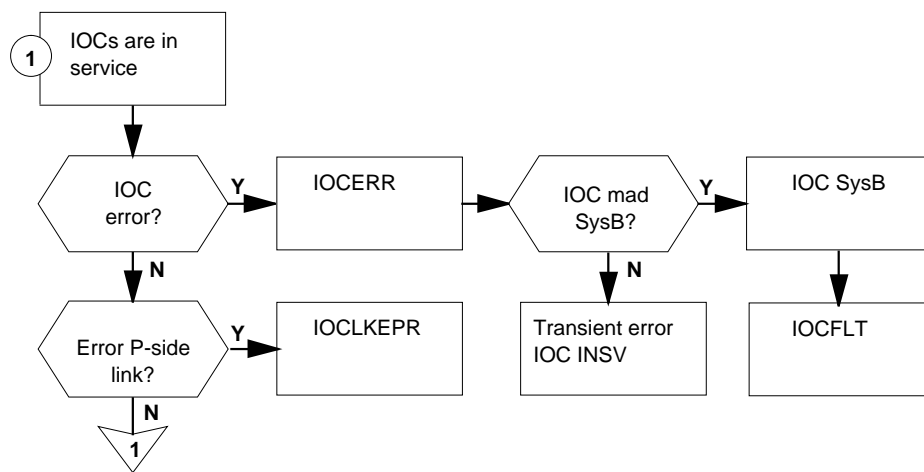

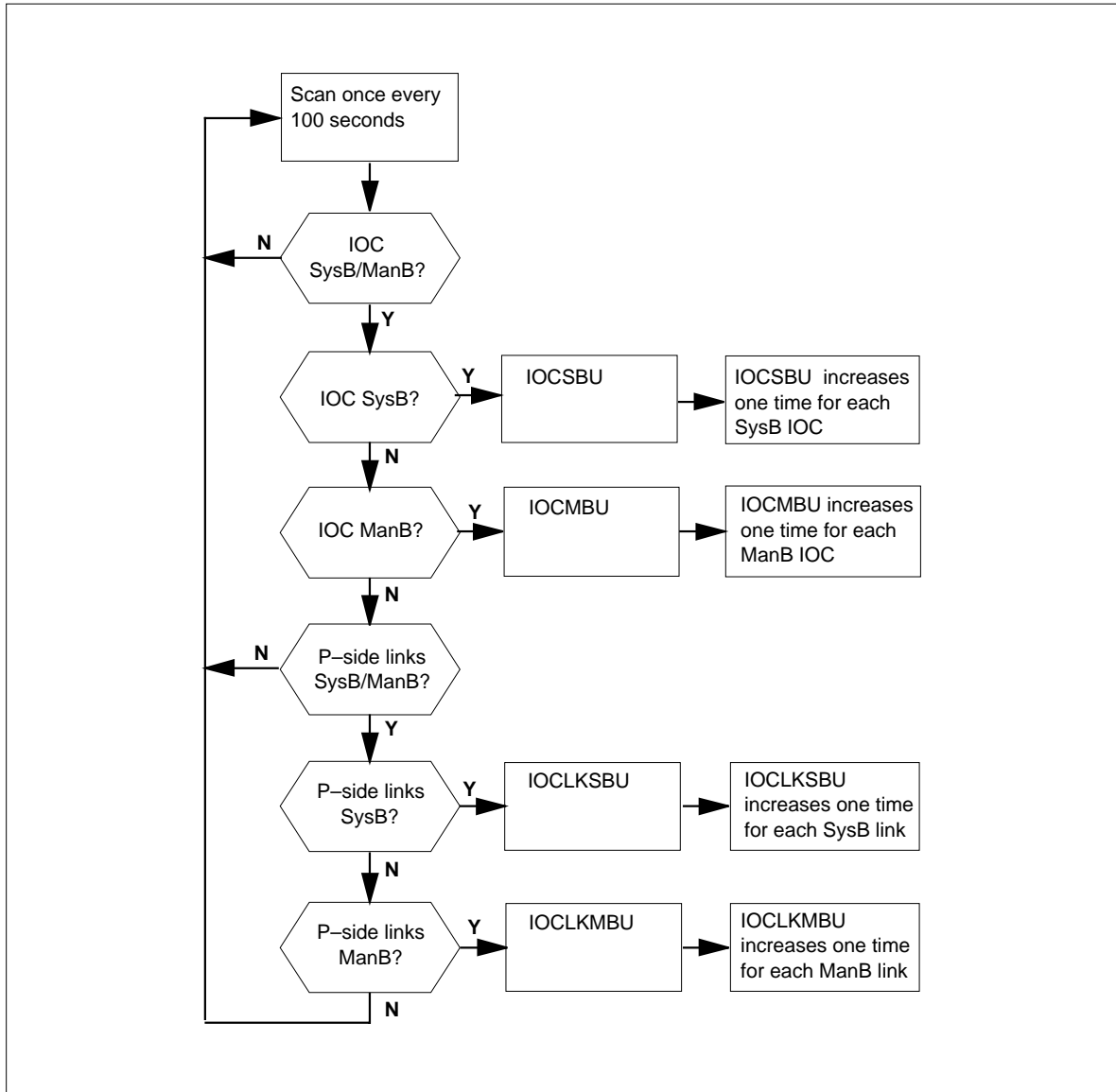
OM group IOC (continued)**OM group IOC use registers****Register IOCERR**

Input/output controller (IOC) errors (IOCERR)

Register IOCERR counts errors the system detects in in-service IOCs. Register IOCERR counts transient errors and errors that make an IOC system busy.

Register IOCERR release history

Register IOCERR was introduced before BCS20.

OM group IOC (continued)

Associated registers

Register IOCFLT counts faults that make an IOC system busy.

Associated logs

The system generates IOD104 when a fault makes an IOC system busy.

The system generates IOD115 when different IOC errors occur.

The system generates IOD118 when a fault occurs during messaging between an IOC and a device controller. The system also generates IOD118 when a fault occurs between an IOC and the CMC.

The system generates IOD119 when a fault occurs during messaging between an IOC and a console device. The system also generates IOD119 when a fault occurs between an IOC and the CMC.

The system generates IOD120 when a discrepancy is present between the value of the maximum device number and the expected value.

The system generates IOD123 when an IOC fails the maximum device number test.

The system generates IOD124 when an IOC fails the memory sequence test.

The system generates IOD125 when an IOC fails the memory pattern test.

The system generates IOD126 when an IOC fails the clock status register test.

The system generates IOD127 when an IOC fails the status register test.

Register IOCFLT

Input/output controller (IOC) faults (IOCFLT)

Register IOCFLT counts faults that make an IOC system busy.

Faults the IOCFLT counts cause an IOC to remain system busy until manual or system intervention corrects the fault. Manual or system intervention returns the IOC to service.

Register IOCFLT release history

Register IOCFLT was introduced before BCS20.

Associated registers

Register IOCERR counts errors the system detects in in-service IOCs.

OM group IOC (continued)

Associated logs

The system generates IOD104 when an error makes an IOC system busy.

The system generates IOD109 when an error makes an IOC port system busy.

The system generates IOD113 when an error makes an IOC port system busy.

The system generates IOD116 when different IOC errors occur.

The system generates IOD118 when a fault occurs during messaging between an IOC and a device controller. The system also generates IOD118 when a fault occurs between an IOC and the CMC.

The system generates IOD119 when a fault occurs during messaging between an IOC and a console device. The system also generates IOD119 when a fault occurs between an IOC and the CMC.

The system generates IOD124 when an IOC fails the memory sequence test.

The system generates IOD125 when an IOC fails the memory pattern test.

The system generates IOD126 when an IOC fails the clock status register test.

The system generates IOD127 when an IOC fails the status register test.

The system generates IOD129 when an IOC port fails a test.

Register IOCLKERR

Input/output controller (IOC) link errors (IOCLKERR)

Register IOCLKERR counts device errors the system detects on the P-side links of an IOC. Register IOCLKERR counts the following errors:

- checksum
- bus overrun
- device not ready

Register IOCLKERR release history

Register IOCLKERR was introduced before BCS20.

Associated registers

There are no associated registers.

OM group IOC (continued)

Associated logs

The system generates IOD117 when a fault occurs during messaging between an IOC and the CMC.

The system generates IOD129 when an IOC port fails a test.

Register IOCLKMBU

Input/output controller (IOC) link manually busy usage (IOCLKMBU)

Register IOCLKMBU is a usage register. The scan rate is 100 s. Register IOCLKMBU records if P-side input/output controller (IOC) links are manually busy.

Register IOCLKMBU release history

Register IOCLKMBU was introduced before BCS20.

BCS33

When office parameter OMINERLANGS is set to Y, the usage count converts from CCS to deci-erlangs before the usage count appears. The OMSHOW command on the ACTIVE class performs the conversion. The value in the active registers is not altered and remains in CCS.

BCS21

Software change to provide usage counts in either CCS or deci-erlangs.

Associated registers

There are no associated registers.

Associated logs

The system generates IOD108 when you manually busy an IOC port.

The system generates IOD112 when you manually busy an IOC port.

Register IOCLKSBU

Input/output link system busy usage (IOCLKSBU)

Register IOCLKSBU is a usage register. The scan rate is 100 s. Register IOCLKSBU records if P-side IOC links are system busy.

Register IOCLKSBU release history

Register IOCLKSBU was introduced before BCS20.

OM group IOC (continued)

BCS33

When office parameter OMINERLANGS is set to Y, the usage count converts from CCS to deci-erlangs before the usage count appears. The OMSHOW command on the ACTIVE class performs the conversion. The value in the active registers is not altered and remains in CCS.

BCS21

Software change to provide usage counts in either CCS or deci-erlangs.

Associated registers

There are no associated registers.

Associated logs

The system generates IOD109 when an error makes IOC port system busy.

The system generates IOD113 when an error makes IOC port system busy.

Register IOCMBU

Input/output controller (IOC) manually busy usage (IOCMBU)

Register IOCMBU is a usage register. The scan rate is 100 s. Register IOCMBU records if IOCs are manually busy.

Register IOCMBU release history

Register IOCMBU was introduced before BCS20.

BCS33

When office parameter OMINERLANGS is set to Y, the usage count converts from CCS to deci-erlangs before the usage count appears. The OMSHOW command on the ACTIVE class performs the conversion. The value in the active registers is not altered and remains in CCS.

BCS21

Software change to provide usage counts in either CCS or deci-erlangs.

Associated registers

There are no associated registers.

Associated logs

The system generates IOD103 when you manually busy an IOC.

Register IOCSBU

Input/output controller (IOC) system busy usage (IOCSBU)

OM group IOC (end)

Register IOCSBU is a usage register. The scan rate is 100 s. Register IOCSBU records if IOCs are system busy.

Register IOCSBU release history

Register IOCSBU was introduced before BCS20.

BCS21

Software change to provide usage counts in either CCS or deci-erlangs.

Associated registers

There are no associated registers.

Associated logs

The system generates IOD104 when an IOC is system busy.

OM group IOSYS

OM description

Input and output system (IOSYS)

The OM group IOSYS counts errors that the input/output (I/O) system detects in incoming or outgoing messages. Examples of problem conditions include errors or rebounded message interrupts that originate in the central message controller (CMC).

Diagnostics determine if the errors counted by IOSYS originate in the CMC or a network message controller (NMC). If the errors originate in the CMC or NMC, groups CMC or NMC count the errors.

Data supplied by IOSYS is used to monitor the performance of the I/O system.

Release history

The OM group IOSYS was introduced in BCS20.

Registers

The OM group IOSYS registers appear on the MAP terminal as follows:



IOSYSERR

Group structure

The OM group IOSYS provides one tuple for each office.

Key field:

There is no key field

Info field:

There is no info field

Associated OM groups

The OM group CMC records:

- errors, faults, or state changes occur in the central message controller
- errors, faults, or state changes occur in the links that associate with the central message controller

OM group IOSYS (continued)

The OM group NMC records:

- errors or state changes occur in network modules or junctors
- errors or state changes occur in in the links for network modules or junctors

Associated functional groups

The following functional group associate with OM group IOSYS:

- DMS-100 Local
- DMS-100/200 Local/Toll
- DMS-100/200 Local/Toll with TOPS
- DMS-200 Toll
- DMS-200 with TOPS
- DMS-100 Meridian
- DMS-MTX Mobile Telephone Exchange
- DMS-250 Toll/Tandem
- DMS-300 Gateway
- Meridian SL-100 PBX

Associated functionality codes

The associated functionality codes for OM group IOSYS appear in the following table.

Functionality	Code
Common Basic	NTX001AA

Register IOSYSERR

Input and output system error (IOSYSERR)

Register IOSYSERR counts errors that the input/output (I/O) system detects on incoming or outgoing messages. Examples of problem conditions include errors or rebounded message interrupts that originate in the CMC.

Register IOSYSERR release history

Register IOSYSERR was introduced before BCS20.

OM group IOSYS (end)

Associated registers

There are no associated registers.

Associated logs

There are no associated logs.

OM group ISDD

OM description

Incoming start-to-dial delay (ISDD)

The OM group ISDD provides information on the grade of service given to incoming trunk calls to a DMS switch. The incoming trunk calls to a DMS switch go through three types of XMS-based peripheral modules (XPM). When the length of time required to complete a call exceeds a defined threshold, the register for each XPM increases.

The system collects ISDD measurements separately for each of the following XPMs:

- digital trunk controllers (DTC)
- line trunk controllers (LTC)
- remote cluster controllers (RCC)

The system collects the information in a DTC, LTC and RCC. The system transmits data to the central control (CC) every 5 or 15 mins.

The system collects a set of four measurements for three different signaling types (pulse types). The system also collects a grouping of all other signaling types. The four measurements are:

- trunk seizures (SEIZ) the system counts when an XPM detects an off-hook condition on an idle incoming trunk
- call attempts (ATMPT) the system counts when the XPM accepts a SEIZ for further processing. This action indicates that the XPM services the call
- trunk delays (TDLY) the system counts when the ISDD exceeds a preset threshold (the default is 3 s). The system also counts the elapsed time between call SEIZ and call abandon (ABDN) exceeds the same threshold
- abandons (ABDN) the system counts when an XPM detects an on-hook condition before the XPM returns the start-to-dial signal. The system counts if the number of abandons exceeds the threshold.

The signaling types are:

- dial pulse (DP), excluding DP immediate type trunks
- digitone (DT)
- multi-frequency (MF)
- all other (OTH) types combined, including DP immediate type trunks

OM group ISDD (continued)**Release history**

The OM group ISDD was introduced in BCS26.

Registers

The OM group ISDD registers appear on the MAP terminal as follows:

DPSEIZ	DPATMPT	DPTDLY	DPABDN
DTSEIZ	DTATMPT	DTTDLY	DTABDN
MFSEIZ	MFATMPT	MFTDLY	MFABDN
OTHSEIZ	OTHATMPT	OTHTDLY	OTHABDN
ISDDMSG			

Group structure

The OM group ISDD provides one tuple for each XPM.

Key field:

There is no key field

Info field:

PM_NAME has three parts

where

site

HOST or site_index number

pm_type

DTC, LTC, or RCC

external XPM number

integer

The XPMs are entered in table LTCINV for DTCs and LTCs, and in table RCCINV for RCCs.

Office parameter ISDD_OM_THRESHOLD in table OFCSTD defines the ISDD threshold. The default value is 3 s. The default value can be set to 1 or 0.5 s.

Associated OM groups

The OM group RADR provides information on the results of receiver attachment delay recorder tests. Receiver attachment time is part of the incoming start-to-dial time interval.

OM group ISDD (continued)

Associated functional groups

The following functional groups associate with OM group ISDD:

- LTC
- DTC
- RCC

Associated functionality codes

The associated functionality codes for the OM group ISDD appear in the following table.

Functionality	Code
New Peripheral Maintenance Package	NTX270AA

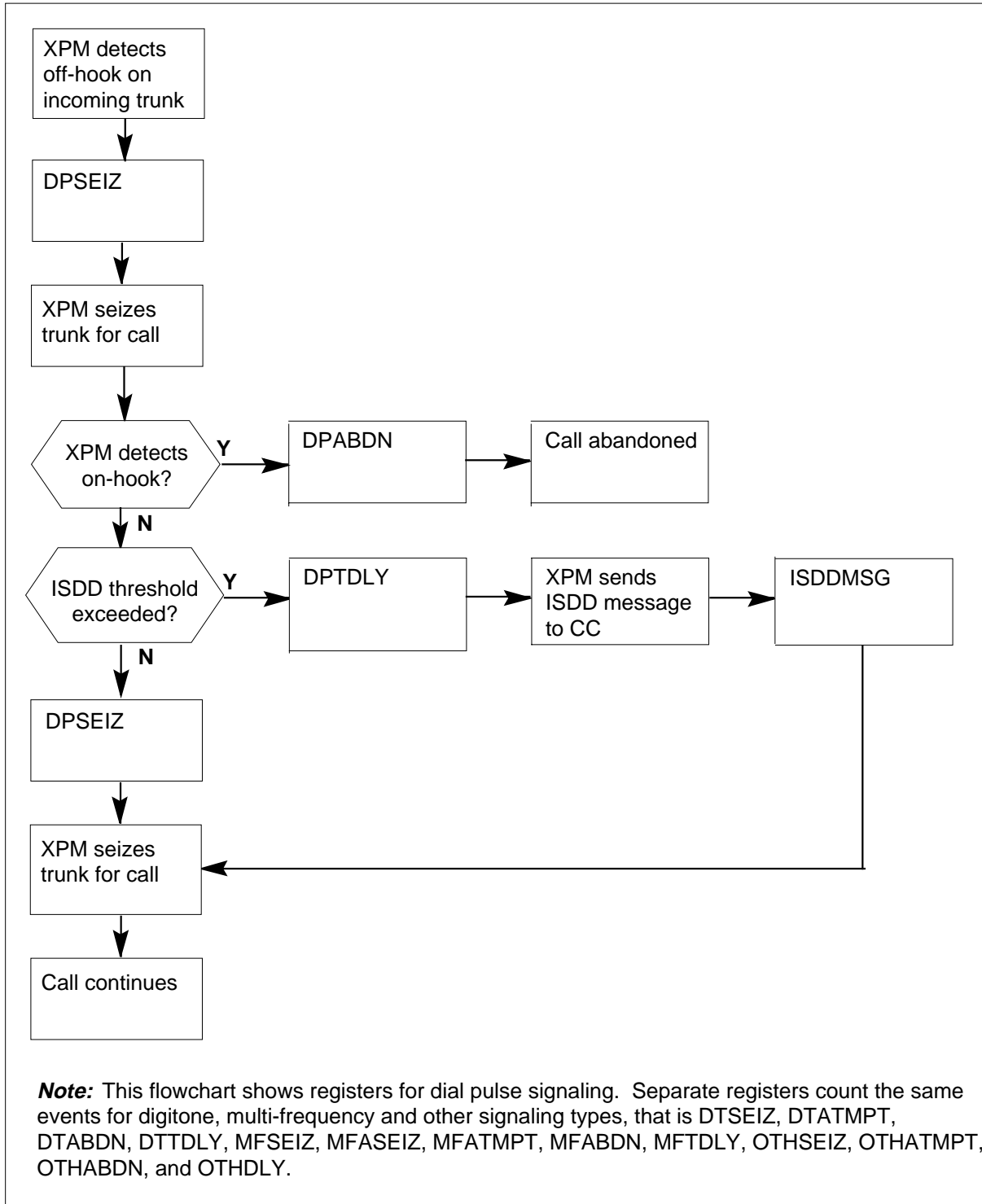
OM group ISDD (continued)**OM group ISDD registers**

OM group ISDD (continued)

Register DPABDN

Dial pulse (DP) abandon (DPABDN)

Register DPABDN increases when an XPM detects an on-hook condition on an incoming DP trunk. The XPM detects the condition before the XPM returns a start-to-dial signal. The system abandons the call.

Register DPABDN does not count DP immediate call ABDNs.

Register DPABDN release history

Register DPABDN was introduced in BCS26.

Associated registers

There are no associated registers.

Associated logs

There are no associated logs.

Extension registers

There are no extension registers.

Register DPATMPT

Dial pulse (DP) attempt (DPATMPT)

Register DPATMPT increases when the XPM accepts a SEIZ of the DP trunk of an XPM for further processing.

Register DPATMPT does not call DP immediate call ATMPTs .

Register DPATMPT release history

Register DPATMPT was introduced in BCS26.

Associated registers

There are no associated registers.

Associated logs

There are no associated logs.

Extension registers

There are no extension registers.

Register DPSEIZ

Dial pulse (DP) seizure (DPSEIZ)

OM group ISDD (continued)

Register DPSEIZ increases when the system seizes a DP trunk of an XPM for an incoming call. The system detects a SEIZ when an XPM detects an off-hook condition. The off-hook condition lasts 6 to 9 ms on an idle incoming trunk.

Register DPSEIZ does not count DP immediate trunk SEIZs.

Register DPSEIZ release history

Register DPSEIZ was introduced in BCS26.

Associated registers

There are no associated registers.

Associated logs

There are no associated logs.

Extension registers

There are no extension registers.

Register DPTDLY

Dial pulse (DP) trunk delay (DPTDLY)

Register DPTDLY increases when one of the following intervals exceeds a preset TDLY threshold:

the interval between the SEIZ of an incoming DP call and the return of the start-to-dial signal

the interval between call SEIZ and call ABDN

The default TDLY threshold is 3 s.

Register DPTDLY does not count DP immediate calls.

Register DPTDLY release history

Register DPTDLY was introduced in BCS26.

Associated registers

There are no associated registers.

Associated logs

There are no associated logs.

OM group ISDD (continued)

Extension registers

There are no extension registers.

Register DTABDN

Digitone (DT) abandon (DTABDN)

Register DTABDN increases when an XPM detects an on-hook condition on an incoming DT trunk. The XPM detects the on-hook condition before the XPM returns a start-to-dial signal. The system abandons the call.

Register DTABDN release history

Register DTABDN was introduced in BCS26.

Associated registers

There are no associated registers.

Associated logs

There are no associated logs.

Extension registers

There are no extension registers.

Register DTATMPT

Digitone (DT) attempt (DTATMPT)

Register DTATMPT increases when the XPM accepts an SEIZ of an incoming DT trunk of an XPM for further processing.

Register DTATMPT release history

Register DTATMPT was introduced in BCS26.

Associated registers

There are no associated registers.

Associated logs

There are no associated logs.

Extension registers

There are no extension registers.

Register DTSEIZ

Digitone (DT) seizure (DTSEIZ)

OM group ISDD (continued)

Register DTSEIZ increases when the system seizes a DT trunk of an XPM for an incoming call. The system detects a SEIZ when an XPM detects an off-hook condition. The off-hook condition that for 6 to 9 ms on an idle incoming trunk.

Register DTSEIZ release history

Register DTSEIZ was introduced in BCS26.

Associated registers

There are no associated registers.

Associated logs

There are no associated logs.

Extension registers

There are no extension registers.

Register DTTDLY

Digitone (DT) trunk delay (DTTDLY)

Register DTTDLY increases when one of the following intervals exceeds a preset TDLY threshold: The default TDLY threshold is 3 s.

the interval between the SEIZ of an incoming DT call and the return of a start-to-dial signal

the interval between call SEIZ and call ABDN, exceeds a preset TDLY threshold

The default TDLY threshold is 3 s.

Register DTTDLY release history

Register DTTDLY was introduced in BCS26.

Associated registers

There are no associated registers.

Associated logs

There are no associated logs.

Extension registers

There are no extension registers.

OM group ISDD (continued)

Register ISDDMSG

Incoming start-to-dial delay (ISDD) message (ISDDMSG)

Register ISDDMSG increases when the CC receives an ISDD message from an XPM.

Register ISDDMSG determines if the system loses any ISDD data messages during transmission from the XPM to the CC. The number of messages that the CC should receive depends on the reporting interval. If the reporting interval is 15 min and OMXFR is 30 min, there should be a count of 2 in ISDDMSG. If the reporting interval is 5 min and OMXFR is 30 min, there should be a count of 6 in ISDDMSG.

Register ISDDMSG release history

Register ISDDMSG was introduced in BCS26.

Associated registers

There are no associated registers.

Associated logs

There are no associated logs.

Extension registers

There are no extension registers.

Register MFABDN

Multi-frequency (MF) abandon (MFABDN)

Register MFABDN increases when an XPM detects an on-hook condition on an incoming MF trunk. The XPM detects the on-hook condition before the XPM returns a start-to-dial signal. The system abandons the call.

Register MFABDN release history

Register MFABDN was introduced in BCS26.

Associated registers

There are no associated registers.

Associated logs

There are no associated logs.

Extension registers

There are no extension registers.

OM group ISDD (continued)

Register MFATMPT

Multi-frequency (MF) attempt (MFAMPT)

Register MFATMPT increases when the XPM accepts a SEIZ of an incoming MF trunk of an XPM for further processing.

Register MFATMPT release history

Register MFATMPT was introduced in BCS26.

Associated registers

There are no associated registers.

Associated logs

There are no associated logs.

Extension registers

There are no extension registers.

Register MFSEIZ

Multi-frequency (MF) seizure (MFSEIZ)

Register MFSEIZ increases when the system seizes an MF trunk of an XPM for an incoming call. The system detects a SEIZ when an XPM detects an off-hook condition lasting for 6 to 9 ms on an idle incoming trunk.

Register MFSEIZ release history

Register MFSEIZ was introduced in BCS26.

Associated registers

There are no associated registers.

Associated logs

There are no associated logs.

Extension registers

There are no extension registers.

Register MFTDLY

Multi-frequency (MF) trunk delay (MFTDLY)

Register MFTDLY increases when one of the following intervals exceeds a preset TDLY threshold:

OM group ISDD (continued)

the interval between the SEIZ of an incoming MF call and the return of a start-to-dial signal

the interval between call SEIZ and call ABDN, exceeds a preset TDLY threshold

The default TDLY threshold is 3 s.

Register MFTDLY release history

Register MFTDLY was introduced in BCS26.

Associated registers

There are no associated registers.

Associated logs

There are no associated logs.

Extension registers

There are no extension registers.

Register OTHABDN

Other (OTH) abandon (OTHABDN)

Register OTHABDN increases when an XPM detects an on-hook condition on an incoming OTH trunk. The XPM detects the on-hook condition before the XPM returns a start-to-dial signal. The system abandons the call.

All trunk types are OTH trunks except for the following:

DP

DT

MF

Integrated Services Digital Network (ISDN)

Common Channel Signaling No. 7 (CCS7)

nailed up

foreign exchange (FX)

maintenance trunks

OM group ISDD (continued)

Register OTHABDN includes DP immediate ABDNs.

Register OTHABDN release history

Register OTHABDN was introduced in BCS26.

Associated registers

There are no associated registers.

Associated logs

There are no associated logs.

Extension registers

There are no extension registers.

Register OTHATMPT

Other (OTH) attempt

OTHATMPT increases when the XPM accepts a SEIZ of an incoming OTH trunk of an XPM for further processing. OTH trunks include all trunk types except DP, DT, MF, ISDN, CCS7, nailed up, FX, and maintenance trunks.

This register counts DP immediate call ATMPTs.

Register OTHATMPT release history

Register OTHATMPT was introduced in BCS26.

Associated registers

There are no associated registers.

Associated logs

There are no associated logs.

Extension registers

There are no extension registers.

Register OTHSEIZ

Other (OTH) seizure (OTHSEIZ)

Register OTHSEIZ increases when the system seizes an OTH trunk of an XPM for an incoming call. All trunk types except DP, DT, MF, ISDN, CCS7, nailed up, FX, and maintenance trunks. The system detects a SEIZ when an XPM detects an off-hook condition. The off-hook condition lasts 6 to 9 ms on an idle incoming trunk.

OM group ISDD (end)

Register OTHSEIZ counts DP immediate trunk SEIZs.

Register OTHSEIZ release history

Register OTHSEIZ was introduced in BCS26.

Associated registers

There are no associated registers.

Associated logs

There are no associated logs.

Extension registers

There are no extension registers.

Register OTHTDLY

Other (OTH) trunk delay (OTHTDLY)

Register OTHTDLY increases when one of the following intervals exceeds a preset TDLY threshold:

the interval between the SEIZ of an incoming OTH call and the return of a start-to-dial signal

the interval between call SEIZ and call ABDN, exceeds a preset TDLY threshold

The default TDLY threshold is 3 s.

Register OTHTDLY release history

Register OTHTDLY was introduced in BCS26.

Associated registers

There are no associated registers.

Associated logs

There are no associated logs.

Extension registers

There are no extension registers.

OM group ISUPCGRP

OM description

ISUP circuit group availability (ISUPCGRP)

The OM group ISUPCGRP provides information on circuit availability for the ISDN user part (ISUP). The system uses this information to determine circuit performance.

Register ISCKTRAC increases when a circuit fails a continuity check test.

Register ISCKTRAO increases when a message is received that is not appropriate. This condition indicates that the circuit is defective and is not available.

Register ISCKTRAE counts exit message (EXM) timeouts that occur on a trunk group. A timeout occurs when the end office expects and does not receive an EXM from a tandem office.

Release history

The OM group ISUPCGRP was introduced in BCS26.

BCS31

Software change to allow this group to contain 8192 tuples.

BCS30

Register ISCKTRAC counts telephone user part plus (TUP+) calls

BCS28

ISCKTRAE was introduced

Registers

The OM group ISUPCGRP registers appear on the MAP terminal as follows:

ISCKTRAC ISCKTRAO ISCKTRAE

Group structure

The OM group ISUPCGRP provides one tuple for each trunk group.

Key field:

There is no associated key field

Info field:

There is no associated info field

OM group ISUPCGRP (continued)

Associated OM groups

The OM group ISUPUSAG counts incoming and outgoing ISUP messages.

The OM group ISUPCKTA counts circuit and circuit group blocking messages the system sends between local and far-end offices.

The OM group ISUPERRS counts the following during call setup and call takedown:

- conditions that are not normal
- messages that are not planned
- the absence of acknowledgement messages

The OM group ISUPCONN counts call attempts that are not successful.

Associated functional groups

The following functional groups associate with OM group ISUPCGRP:

- ISDN integrated services digital network
- CCS7 Common Channel Signaling 7

Associated functionality codes

The associated functionality codes for OM group ISUPCGRP. appear in the following table.

Functionality	Code
TUP+ on DMS-300	NTXK06AA
Common Basic	NTX001AA
ISUP Operational Measurements	NTX167AB

OM group ISUPCGRP (continued)

OM group ISUPCGRP registers

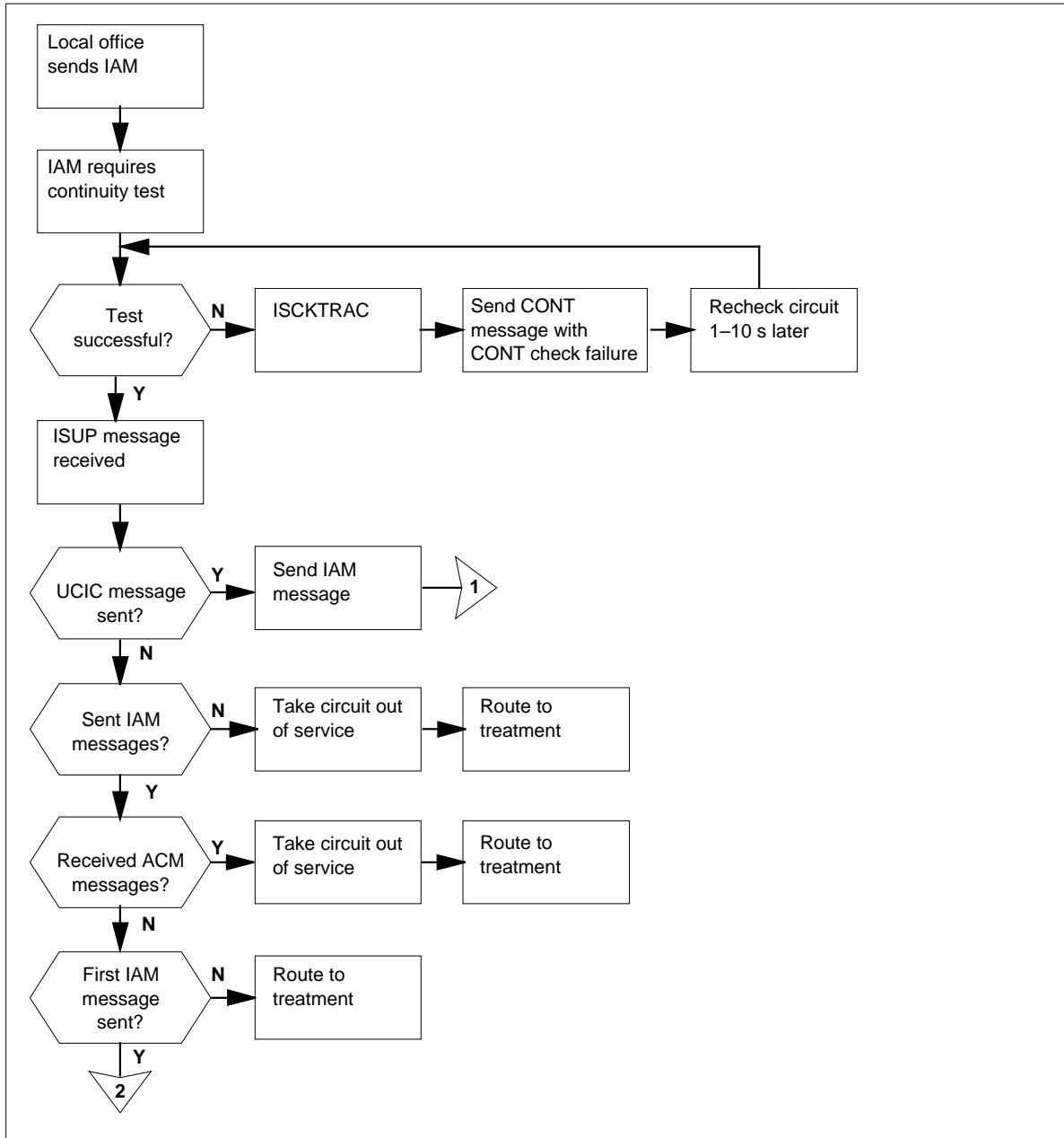

OM group ISUPCGRP (continued)

OM group ISUPCGRP registers (continued)

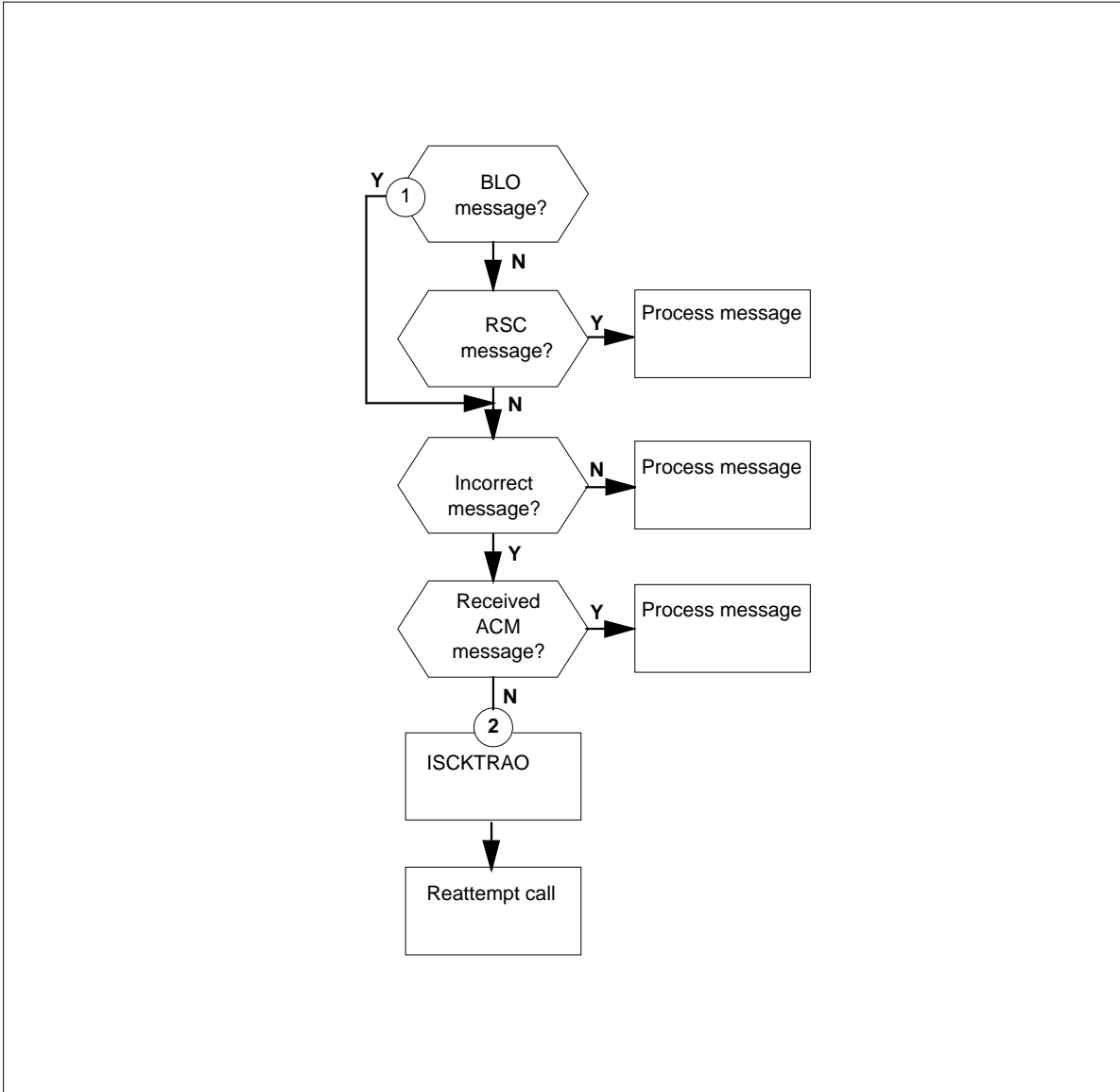

Register ISCKTRAC

ISUP circuit reattempt continuity (ISCKTRAC)

Register ISCKTRAC increases when a circuit in a trunk group fails a continuity check test. The initial address message (IAM) requests the test for the circuit on which a call is made.

Register ISCKTRAC release history

Register ISCKTRAC was introduced in BCS26.

OM group ISUPCGRP (continued)

BCS30

Register ISCKTRAC counts TUP+ calls.

Associated registers

There are no associated registers.

Associated logs

There are no associated logs.

Register ISCKTRAO

ISUP circuit reattempt other reasons (ISCKTRAO)

Register ISCKTRAO counts automatic repeat call setup attempts that occur for each trunk group for reasons other than:

- two-seizure detections
- continuity check test failures

Register ISCKTRAO increases for the following reasons:

- a blocking message is received after the initial address message (IAM) is sent and before an acknowledgement is received
- a reset circuit message is received after an IAM is received before an acknowledgement is received
- any other messages that are not appropriate are received before the address complete message (ACM) is received
- an unequipped circuit identification code (UCIC) message is received on a first attempt

ISCKTRAO release history

Register ISCKTRAO was introduced in BCS26.

Associated registers

There are no associated registers.

Associated logs

There are no associated logs.

Register ISCKTRAE

ISUP trunk group exit messages (ISCKTRAE)

OM group ISUPCGRP (end)

Register ISCKTRAE counts exit message (EXM) timeouts that occur on a trunk group. A timeout occurs when the end office expects and does not receive an EXM from a tandem office.

Register ISCKTRAE release history

Register ISCKTRAE was introduced in BCS28.

Associated registers

There are no associated registers.

Associated logs

The system generates C7UP102 when an EXM timeout occurs in an office. An EXM timeout occurs because a carrier fails to respond to CCS7 equal access protocol.

OM group ISUPCKTA

OM description

ISUP circuit availability (ISUPCKTA)

The OM group ISUPCKTA counts circuit and circuit group blocking and unblocking messages sent between near- and far-end offices. The OM group ISUPCKTA counts determine overall circuit performance for the ISDN user part (ISUP).

Local or remote offices can block separate circuits. The system diverts traffic from blocked circuits for circuit testing and servicing. Two methods are used to unblock a circuit:

- Maintenance personnel originate an unblock (UBL) message or switching equipment at the near-end office returns a blocked circuit to service from the far-end office.
- An initial address message (IAM) received from a far-end office returns a remotely blocked circuit at the near-end office to service.

Registers that count available groups of circuits have also been created. These registers are activated when a future BCS group message sending procedure is implemented.

Release history

The OM group ISUPCKTA was introduced in BCS26. Registers ISCKTGBT, ISCKTGBF, and ISCKTCGU are not active until a future BCS.

GL04

The OM group ISUPCKTA was introduced in GL04.

Registers ISCKTLBT and ISCKTRBT are not increased in GL04.

Registers

The OM group ISUPCKTA registers appear on the MAP terminal as follows:

ISCKTBLO	ISCKTUBL	ISCKTGBT	ISCKTGBF
ISCKTCGU	ISCKTLBT	ISCKTRBT	

Group structure

The OM group ISUPCKTA provides one tuple for each office.

OM group ISUPCKTA (continued)

Key field:

There is no key field.

Info field:

There is no info field.

Associated OM groups

The OM group ISUPCGRP counts the circuits that are available for each trunk.

The OM group ISUPCONN counts the call attempts that are not successful.

The OM group ISUPERRS counts conditions that are not normal and messages that are not expected. The ISUPERRS also counts the absence of acknowledgment messages during call setup and call takedown.

The ISUPUSAG counts incoming and outgoing ISUP messages.

Associated functional groups

The ISDN integrated services digital network functional group associates with OM group ISUPCKTA.

Associated functionality codes

The functionality codes associated with OM group ISUPCKTA appear in the following table.

Functionality	Code
ISUP Operational Measurements	NTX167AB

OM group ISUPCKTA (continued)

OM group ISUPCKTA near-end registers

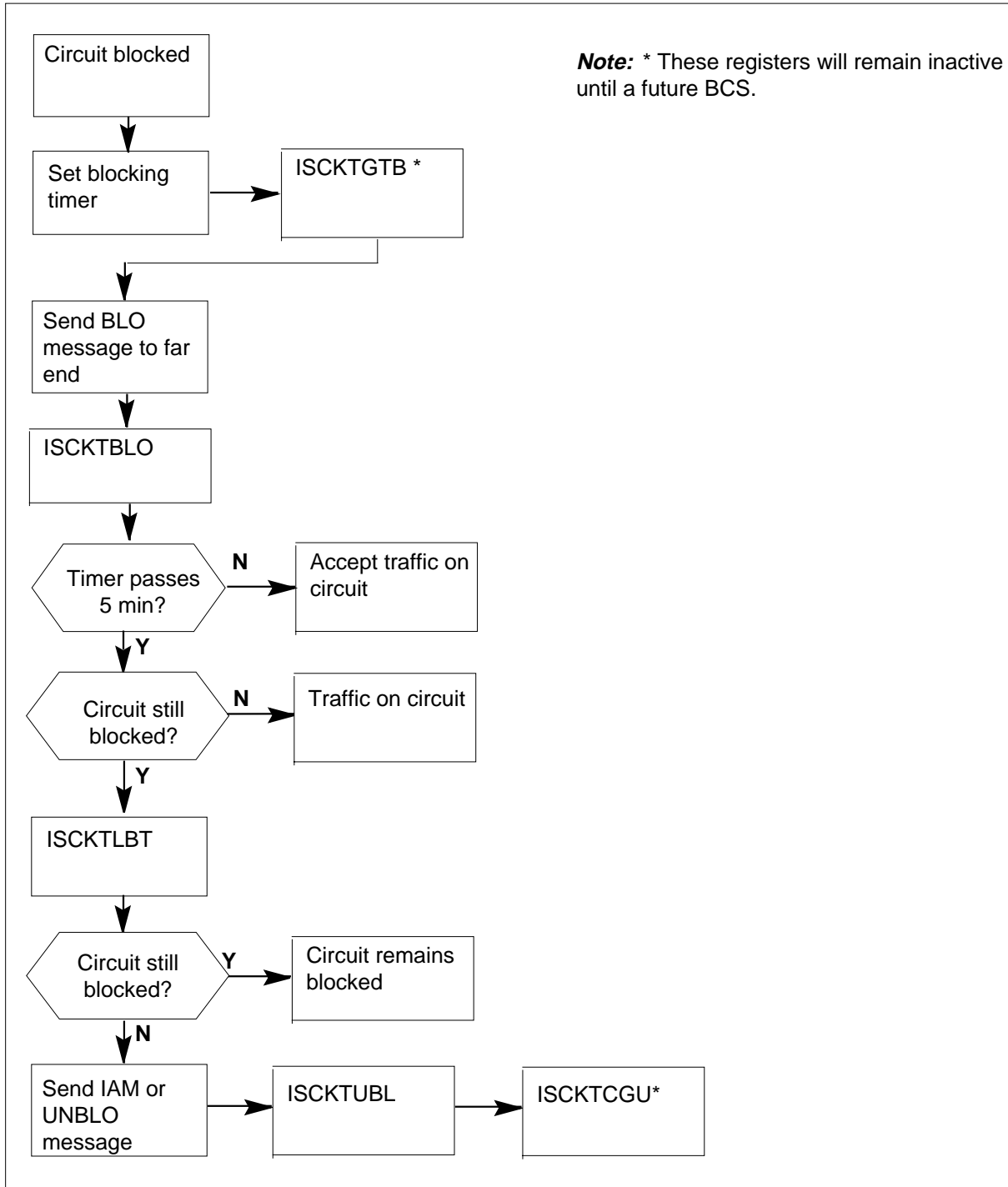

OM group ISUPCKTA (continued)

OM group ISUPCKTA far-end registers

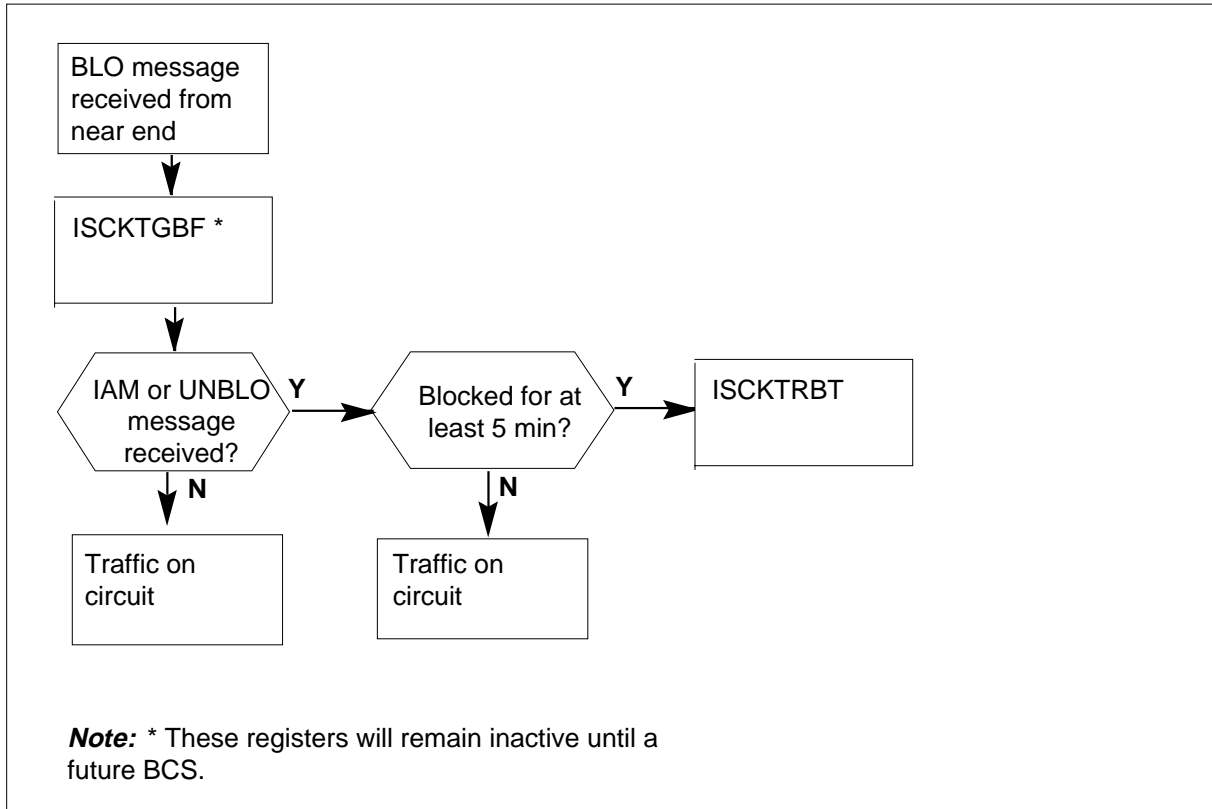

Register ISCKTBLO

ISUP circuit blocked (ISCKTBLO)

Register ISCKTBLO counts circuit blocking messages sent to remove traffic from a circuit. The register prevents the far-end office from originating outgoing calls on a blocked circuit.

Register ISCKTBLO release history

Register ISCKTBLO was introduced in BCS26.

Associated registers

There are no associated registers.

Associated logs

The C7UP103 reports blocked or unblocked circuit conditions.

Extension registers

There are no extension registers.

OM group ISUPCKTA (continued)

Register ISCKTCGU

ISUP circuit group unblock (ISCKTCGU)

Register ISCKTCGU counts the following circuit group unblocking messages that an office sends:

- maintenance-oriented group unblocking.
- hardware failure-oriented group unblocking.
- software-generated group unblocking.

Register ISCKTCGU counts for each trunk in the group.

Register ISCKTCGU release history

Register ISCKTCGU was introduced in BCS26 but is not active.

Associated registers

There are no associated registers.

Associated logs

The system generates C7UP104 to report group blocking or unblocking conditions.

Extension registers

There are no extension registers.

Register ISCKTGBF

ISUP circuit group blocked failure (ISCKTGBF)

Register ISCKTGBF counts circuit group blocking messages that the system sends again after the first attempt to send messages fails. Failure occurs when the time allowed for acknowledgment elapses before the acknowledgment message is received.

Circuits are automatically released from all calls when the system receives a circuit group blocking message.

Register ISCKTGBF release history

The definition of register ISCKTGBF was corrected in NA005.

Register ISCKTGBF was introduced in BCS26 but is not active.

Associated registers

There are no associated registers.

OM group ISUPCKTA (continued)

Associated logs

The system generates C7UP104 logs to report group blocking or unblocking conditions.

Extension registers

There are no extension registers.

Register ISCKTGBT

ISUP circuit group blocked this end (ISCKTGBT)

Register ISCKTGBT counts circuit group blocking messages sent to block a circuit group at the far-end office for maintenance or software-generated reasons. This action does not affect calls on the circuits. Register ISCKTGBT counts circuit group blocking messages for each trunk in the group.

Register ISCKTGBT release history

Register ISCKTGBT was introduced in BCS26. Register ISCKTGBT will not be active until a future BCS.

Associated registers

There are no associated registers.

Associated logs

The system generates C7UP104 logs to report group blocking or unblocking conditions.

Extension registers

There are no extension registers.

Register ISCKTLBT

ISUP circuit locally blocked (ISCKTLBT)

Register ISCKTLBT counts circuits that are locally blocked for five min. This action blocks outgoing calls on this circuit at the far-end office. The system sends a blocking message to the far-end office.

Register ISCKTLBT is not increased for GL04.

Register ISCKTLBT release history

Register ISCKTLBT was introduced in BCS26.

GL04

Register ISCKTLBT is not increased.

OM group ISUPCKTA (continued)

Associated registers

There are no associated registers.

Associated logs

The system generates C7UP103 logs to report blocked or unblocked circuit conditions.

Extension registers

There are no extension registers.

Register ISCKTRBT

ISUP circuit remote blocked (ISCKTRBT)

Register ISCKTRBT counts circuits that are blocked from a far-end office for 5 min. The register counts once for each blockage at the 5 min mark.

Register ISCKTRBT is not increased for GL04.

Register ISCKTRBT release history

Register ISCKTRBT was introduced in BCS26.

GL04

Register ISCKTRBT is not increased.

Associated registers

There are no associated registers.

Associated logs

The system generates C7UP103 logs to report blocked or unblocked circuit conditions. If work on the trunk must exceed five min, personnel at the far-end office must remove the circuit from service.

Extension registers

There are no extension registers.

Register ISCKTUBL

ISUP circuit unblocked

Register ISCKTUBL counts circuit unblocking messages that an office sends to cancel the blocked condition of a circuit. Register ISCKTUBL increases when the system receives an initial address message (IAM) from a far-end office to attempt a call on a blocked circuit. The circuit is automatically unblocked when the system receives the IAM message.

OM group ISUPCKTA (end)

Register ISCKTUBL release history

Register ISCKTUBL was introduced in BCS26.

Associated registers

There are no associated registers.

Associated logs

The system generates C7UP103 logs to report blocked or unblocked circuit conditions.

Extension registers

There are no extension registers.

OM group ISUPCONG

OM description

ISUP Congestion

Release history

The OM group ISUPCONG was introduced in NA008.

Registers

The OM group ISUPCONG register appears on the MAP terminal as follows:

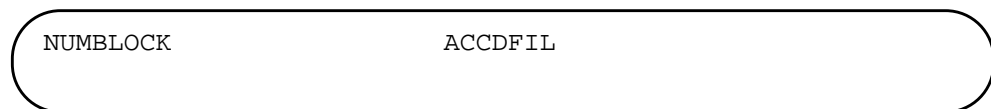

Group structure

The OM group ISUPCONG provides one tuple for each office.

Key field:

COMMON_LANGUAGE_NAME

Info field:

There is no info field.

Associated OM groups

There are no associated OM groups.

Associated functional groups

There are no associated functional groups

Associated functionality codes

The functionality codes associated with the OM group ISUPCONG appear in the following table.

Functionality	Code
ISP7 Automatic Congestion Controls	ISP73003

OM group ISUPCONG (continued)

OM group ISUPCONG register: trunk termination

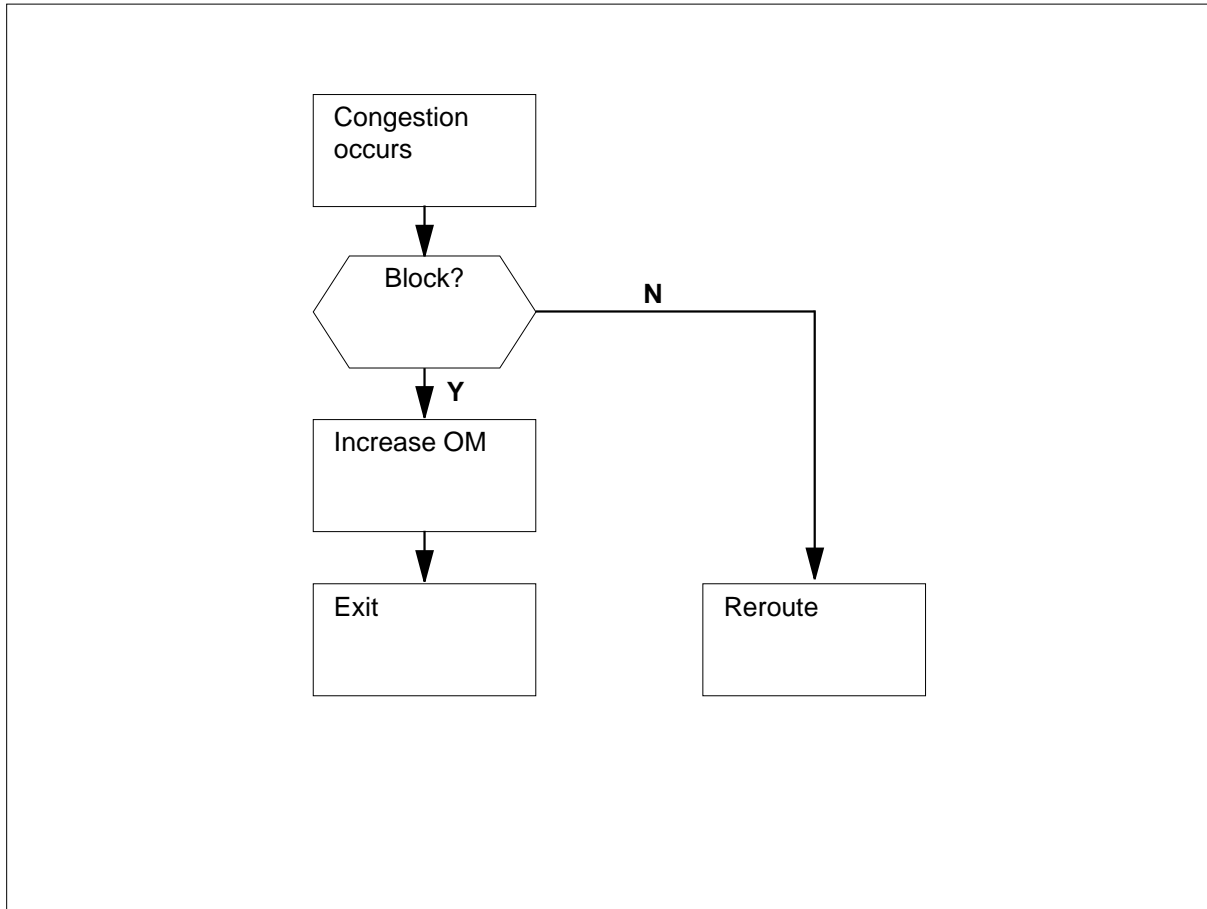

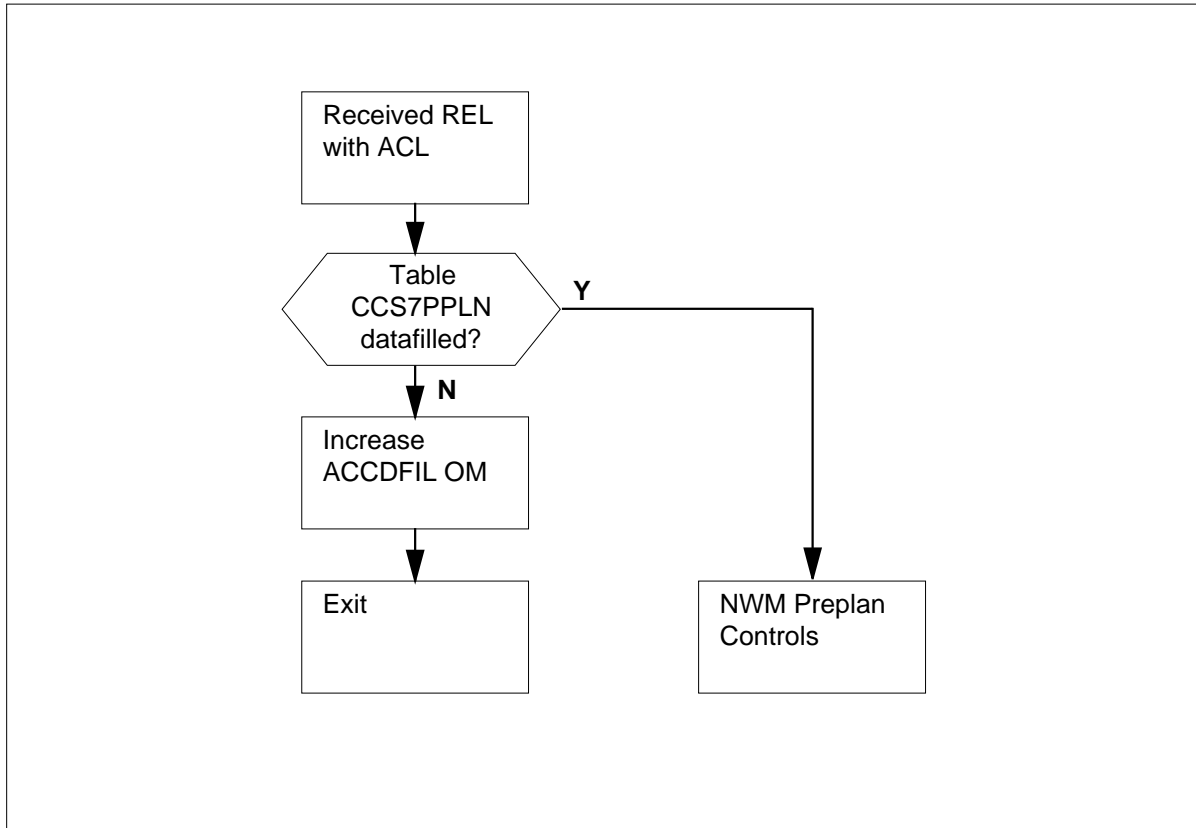
OM group ISUPCONG (continued)**OM group ISUPCONG register: trunk disconnect****Register NUMBLOCK**

Register Number of Blocked Calls (NUMBLOCK)

Register NUMBLOCK counts the total number of blocked calls that transfer controlled (TFC) and transfer prohibited (TFP) cause. These blocked calls are caused when the BLOCK option in table TRKSGRP is on.

Register NUMBLOCK release history

Register NUMBLOCK was introduced in NA008.

Associated registers

There are no associated registers.

Associated logs

There are no associated logs.

Extension registers

There are no extension registers.

OM group ISUPCONG (end)

Register ACCDFIL

Automatic Congestion Control Datafill (ACCDFIL)

Register ACCDFIL is used to increase the number of times a trunk group detected ACL but could not apply network management (NWM) controls. The NWM controls could not be applied because of missing datafill in table CCS7PPLN.

The technician can take the trunk CLI and reference table ISUPDEST to determine the point code name of the office experiencing congestion. Refer to table C7RTESET and use the point code name to determine the accurate CCS7 point code.

Refer to tables NWMPPLN, PREPLANS, and CCS7PPLN to implement NWM controls.

Register ACCDFIL release history

Register ACCDFIL was introduced in NA008.

Associated registers

There are no associated registers.

Associated logs

There are no associated logs.

Extension registers

There are no extension registers.

OM group ISUPCONN

OM description

ISUP connection

ISUP connection (ISUPCONN) provides information on circuit availability and call attempts that are not successful. This information determines how the surrounding network affects ISDN user part (ISUP) performance.

Release history

The OM group ISUPCONN was introduced in BCS26.

BCS30

The following registers count TUP+ calls:

- ISCONBAD
- ISCONBD2
- ISCONUCE
- ISCONUCC
- ISCONUCA
- ISCONUCF
- ISCONUCN
- ISCONUCB
- ISCONUB2
- ISCONUCS
- ISCONUCO
- ISCONUO2

Registers

The OM group ISUPCONN registers display on the MAP terminal as follows:

ISCONBAD	ISCONBD2	ISCONUCE	ISCONUCC
ISCONUCA	ISCONUCF	ISCONUCN	ISCONUCB
ISCONUB2	ISCONUCS	ISCONUCO	ISCONUO2
ISCONCOT	ISCONICC	ISCONIC2	ISCONFAR
ISCONINR			

Group structure

The OM group ISUPCONN provides one tuple for each office.

OM group ISUPCONN (continued)

Key field:

There is no Key field.

Info field:

There is no Info field.

Associated OM groups

The OM group ISUPCGRP provides information on circuit availability.

The OM group ISUPCKTA counts circuit and circuit group blocking messages between near-end and far-end offices.

The OM group ISUPERRS counts conditions that are not normal, messages that are not expected, and the absence of messages that acknowledge. This OM group performs these counts during call setup and call take down.

The OM group ISUPUSAG counts incoming and outgoing ISUP messages.

Associated functional groups

The following functional groups associate with the OM group ISUPCONN:

- The ISDN integrated services digital network
- The CCS7 Common Channel Signaling 7

Associated functionality codes

The functionality codes that associate with the OM group ISUPCONN appear in the following table.

Functionality	Code
ISUP Operational Measurements	NTX167AB
TUP+ on DMS-300	NTXK06AA

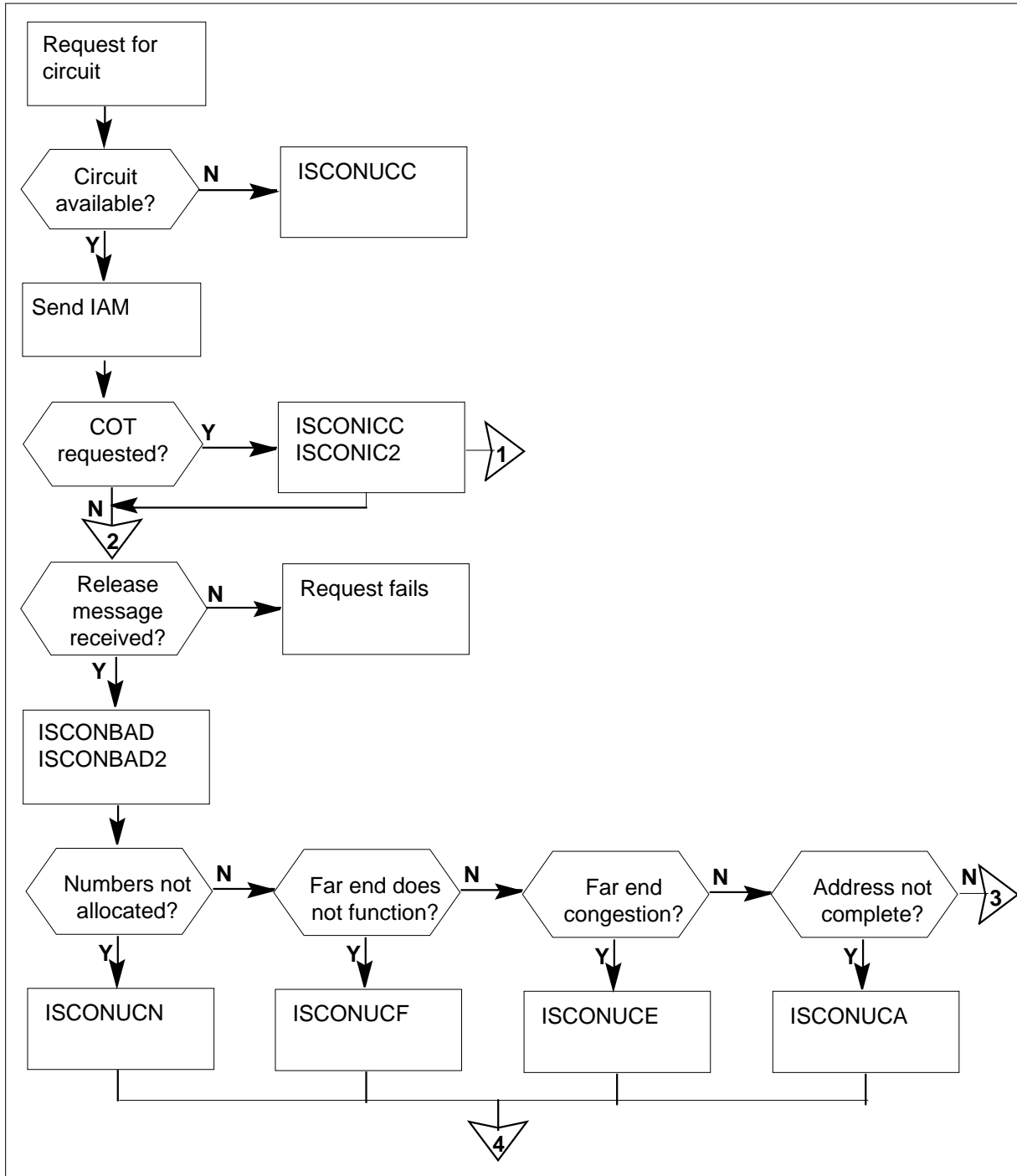
OM group ISUPCONN (continued)**OM group ISUPCONN registers**

OM group ISUPCONN (continued)

OM group ISUPCONN registers (continued)

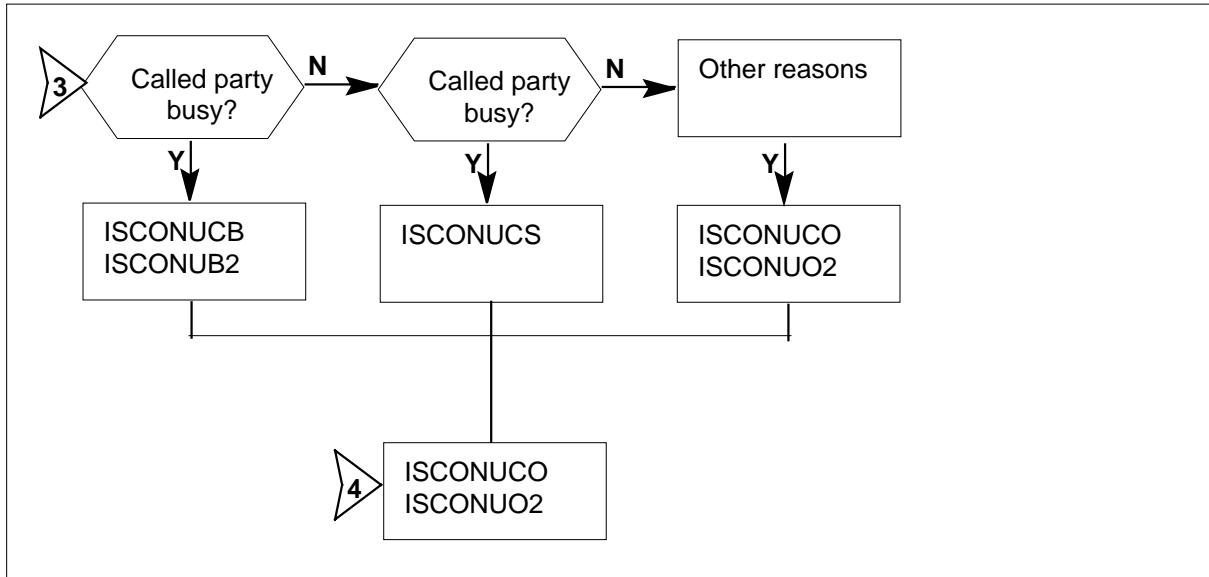

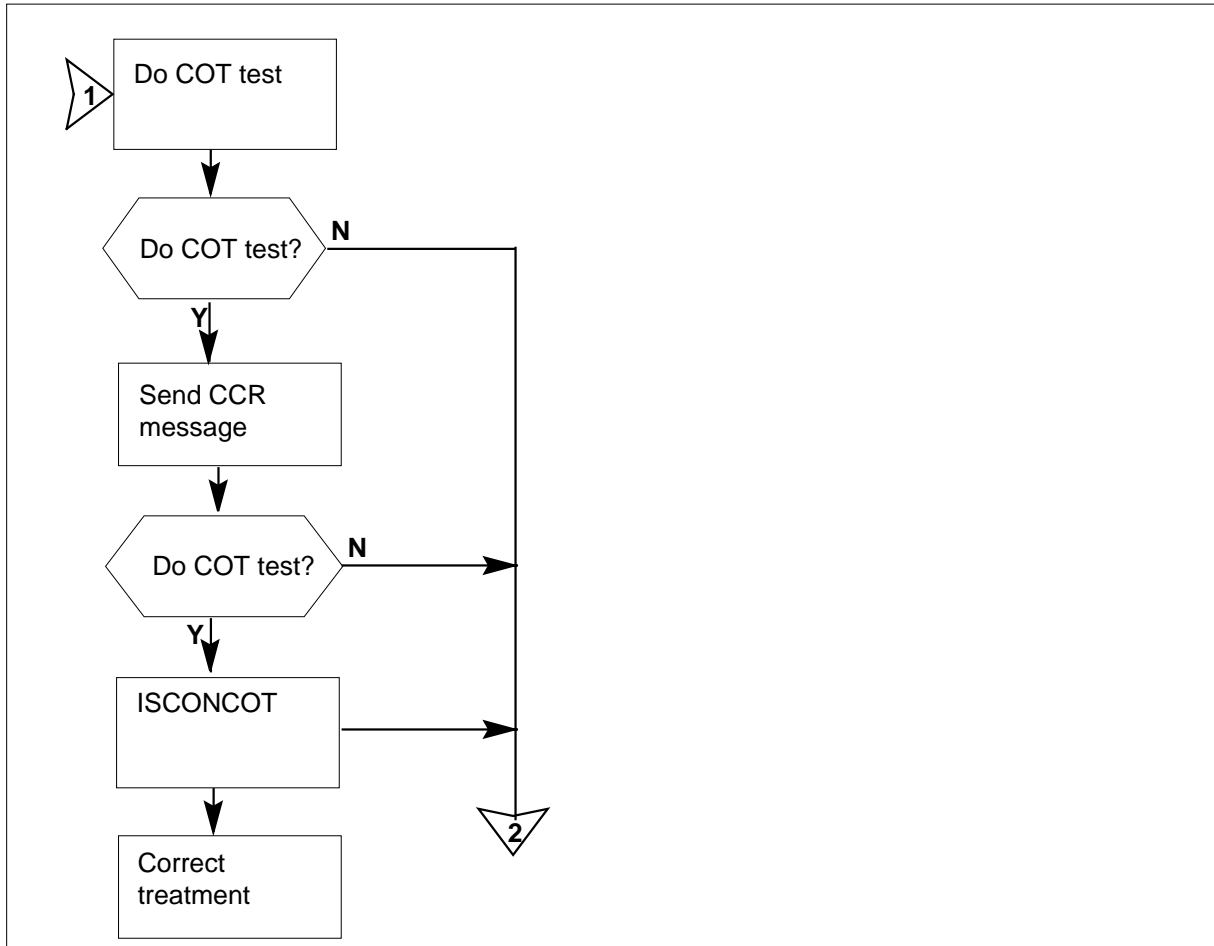
OM group ISUPCONN (continued)**OM group ISUPCONN - continuity checks****Register ISCONBAD**

ISUP bad

The ISUP bad (ISCONBAD) register counts call attempts that fail during call setup. When a call attempt fails during call setup, the originating office receives a release message instead of an address complete message.

Register ISCONBAD release history

Register ISCONBAD was introduced in BCS26.

BCS30

Register ISCONBAD counts TUP+ calls.

Associated registers

There are no associated registers.

OM group ISUPCONN (continued)

Associated logs

There are no associated logs.

Extension registers

ISCONBD2

Register ISCONCOT

ISUP continuity

The ISUP continuity (ISCONCOT) register counts calls that fail the first continuity check test. The continuity check request (CCR) message initiates the first continuity check test.

The CCR message performs an automatic recheck 10 s after the first continuity check failure.

Register ISCONCOT release history

Register ISCONCOT was introduced in BCS26.

Associated registers

There are no associated registers.

Associated logs

The system generates log C7UP107 when a continuity check test runs on an outgoing trunk.

Extension registers

There are no extension registers.

Register ISCONFAR

ISUP facility request

The ISUP facility request (ISCONFAR) counts failures. These failures occur when there is no response to the second attempt to send a facility request message.

Register ISCONFAR release history

Register ISCONFAR was introduced in BCS26. Register ISCONFAR is inactive.

Associated registers

There are no associated registers.

OM group ISUPCONN (continued)

Associated logs

The system generates log C7UP108 when the system does not receive a response to a facility request message or information request message.

Extension registers

There are no extension registers.

Register ISCONICC

ISUP continuity check

The ISUP continuity check (ISCONICC) register counts calls that receive the continuity check test. This count occurs at the office that performs the continuity check test that the initial address message requests.

Register ISCONICC release history

Register ISCONICC was introduced in BCS26.

Associated registers

There are no associated registers.

Associated logs

There are no associated logs.

Extension register

ISCONIC2

Register ISCONINR

ISUP information request

The ISUP information request (ISCONINR) counts failures. These failures occur when there is no response to a second attempt to send an information request message.

Register ISCONINR release history

Register ISCONINR was introduced in BCS26. Register ISCONINR is inactive.

Associated register

There are no associated registers.

Associated logs

The system generates log C7UP108 when the system does not receive a response to a facility request message or information request message.

OM group ISUPCONN (continued)

Extension registers

There are no extension registers.

Register ISCONUCA

ISUP unsuccessful address

The ISUP unsuccessful address (ISCONUCA) register counts call attempts that are not successful. These call attempts are not successful because another office determines one of the following conditions. The office determines that the number is not in a valid format, or that the number is not complete.

Register ISCONUCA release history

Register ISCONUCA was introduced in BCS26.

BCS30

Register ISCONUCA counts TUP+ calls.

Associated register

There are no associated registers.

Associated logs

The system generates log C7UP105 when an ISDN call attempt is not successful.

Extension registers

There are no extension registers.

Register ISCONUCB

ISUP unsuccessful busy

The ISUP unsuccessful busy (ISCONUCB) register counts call attempts that are not successful because the called party is busy.

Register ISCONUCB release history

The ISCONUCB was introduced in BCS26.

BCS30

The ISCONUCB counts TUP+ calls.

Associated registers

There are no associated registers.

OM group ISUPCONN (continued)

Associated logs

There are no associated logs.

Extension register

ISCONUB2

Register ISCONUCC

ISUP unsuccessful circuit

The ISUP unsuccessful circuit (ISCONUCC) counts call attempts that are not successful. These call attempts fail because there are no correct idle circuits in another office to handle the call.

Register ISCONUCC release history

Register ISCONUCC was introduced in BCS26.

BCS30

Register ISCONUCC counts TUP+ calls.

Associated registers

There are no associated registers.

Associated logs

The system generates C7UP106 when problems occur because not enough resources are available.

Extension registers

There are no extension registers.

Register ISCONUCE

ISUP unsuccessful

The ISUP unsuccessful (ISCONUCE) register counts call attempts that are not successful. These call attempts fail because switching equipment in another office handles too many calls.

Register ISCONUCE release history

Register ISCONUCE was introduced in BCS26.

BCS30

Register ISCONUCE counts TUP+ calls.

OM group ISUPCONN (continued)

Associated registers

There are no associated registers.

Associated logs

The system generates C7UP106 when problems occur because not enough resources are available.

Extension registers

There are no extension registers.

Register ISCONUCF

ISUP unsuccessful faults

The ISUP unsuccessful faults (ISCONUCF) register counts call attempts that are not successful. These call attempts fail because of a temporary fault in the network at the far end.

Register ISCONUCF release history

Register ISCONUCF was introduced in BCS26.

BCS30

Register ISCONUCF counts TUP+ calls.

Associated registers

There are no associated registers.

Associated logs

The system generates C7UP106 when problems occur because not enough resources are available.

Extension registers

There are no extension registers.

Register ISCONUCN

ISUP unsuccessful numbers

The ISUP unsuccessful numbers (ISCONUCN) register counts call attempts that are not successful. These call attempts fail because the dialed number is a blank directory number in the far-end office.

Register ISCONUCN release history

Register ISCONUCN was introduced in BCS26.

OM group ISUPCONN (continued)

BCS30

Register ISCONUCN counts TUP+ calls.

Associated registers

There are no associated registers.

Associated logs

The system generates log C7UP105 when an ISDN call attempt is not successful.

Extension registers

There are no extension registers.

Register ISCONUCO

ISUP unsuccessful other

The ISUP unsuccessful other (ISCONUCO) register counts call attempts that are not successful because of reasons other than the following:

- destination out-of-service faults
- called party busy condition
- numbers not allocated
- temporary faults
- address not complete
- circuit not available
- switching equipment congestion

The system records the reason the call attempt is not successful in the cause field of the release message to the office.

Register ISCONUCO release history

Register ISCONUCO was introduced in BCS26.

BCS30

Register ISCONUCO counts TUP+ calls.

Associated registers

There are no associated registers.

Associated logs

There are no associated logs.

OM group ISUPCONN (end)

Extension registers

ISCONUO2

Register ISCONUCS

ISUP unsuccessful service

The ISUP unsuccessful service (ISCONUCS) register counts call attempts that are not successful. These call attempts fail because an equipment failure occurs at the far-end office. These call attempts also can fail because the directory number of the called party is disconnected or out of service.

Register ISCONUCS release history

Register ISCONUCS was introduced in BCS26.

BCS30

Register ISCONUCS counts TUP+ calls.

Associated registers

There are no associated registers.

Associated logs

There are no associated logs.

Extension registers

There are no associated extension registers.

OM group ISUPERRS

OM description

ISDN user part errors

The ISDN user part errors (ISUPERRS) OM group counts abnormal conditions, unexpected messages, and the absence of acknowledgement messages during call setup and call takedown and during maintenance procedures. These counts are used by maintenance personnel to track ISDN user part (ISUP) stability.

If the far end has difficulty in routing a call during call setup, it sends a release (RLS) message to the originating office. The reason for the failure is included in the message. When the RLS message is received, the call is released from the far end. To take down a call, the first party that goes on-hook sends a RLS message. In response, a release complete (RLC) message is sent from the other end. Timers ensure that the call is not left in an inactive state. If the RLC message is not sent within one minute after receipt of an RLS message, the RLS message is sent again. If there is still no response, the far end sends a reset circuit (RSC) message.

Release history

OM group ISUPERRS was introduced in BCS26.

NA005

Register ISERRHOP was added to the group.

BCS32

Register ISERRREL is incremented by the ISUP to Telephone User Part (TUP) Interworking feature.

BCS30

Register ISERRREL counts calls between British telephone user part (BTUP) trunks and TUP plus (TUP+) trunks, as well as between T101 test lines and BTUP, TUP, and TUP+ trunks.

Registers

OM group ISUPERRS registers display on the MAP terminal as follows:

ISERRRSC	ISERRGRS	ISERRBLO	ISERRBAD
ISERRRLC	ISERRREL	ISERRHOP	

OM group ISUPERRS (continued)

Group structure

OM group ISUPERRS provides one tuple per office.

Key field:

None

Info field:

None

Associated OM groups

ISUPCGRP counts available circuits for each trunk.

ISUPCKTA counts circuit and circuit group blocking messages sent between local and far-end offices.

ISUPCONN counts unsuccessful call attempts.

ISUPUSAG counts incoming and outgoing ISUP messages.

Associated functional groups

The following functional groups are associated with OM group ISUPERRS:

- ISDN
- Common Channel Signaling 7 (CCS7)

Associated functionality codes

The functionality codes associated with OM group ISUPERRS are shown in the following table.

Functionality	Code
ISUP Operational Measurements	NTX167AB
BTUP on DMS-300	NTXK05AA
TUP+ on DMS-300	NTXK06AA
ISC Maintenance	NTX301AA

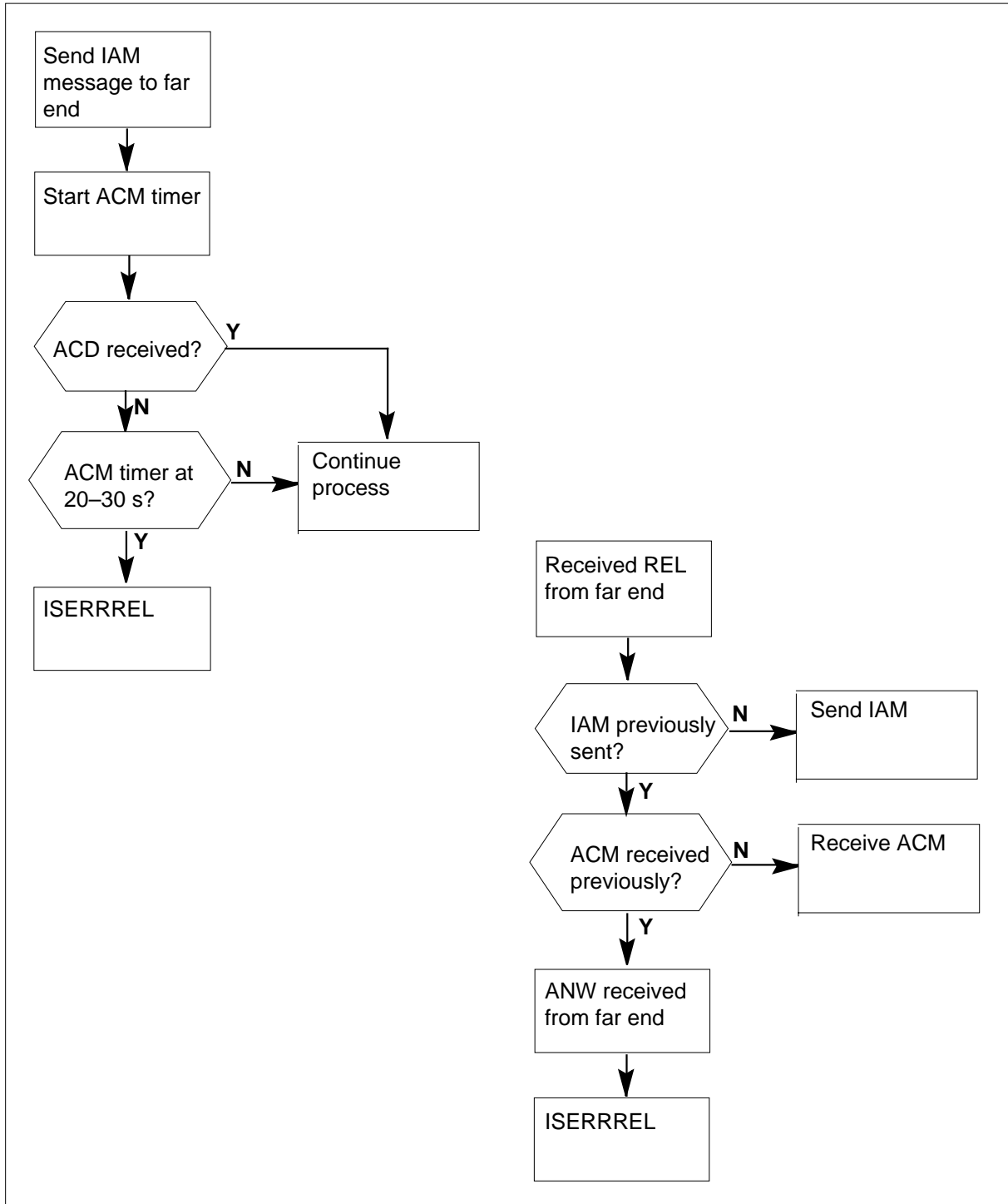
OM group ISUPERRS (continued)**OM group ISUPERRS abnormal conditions - near end**

OM group ISUPERRS (continued)

OM group ISUPERRS abnormal conditions - far end

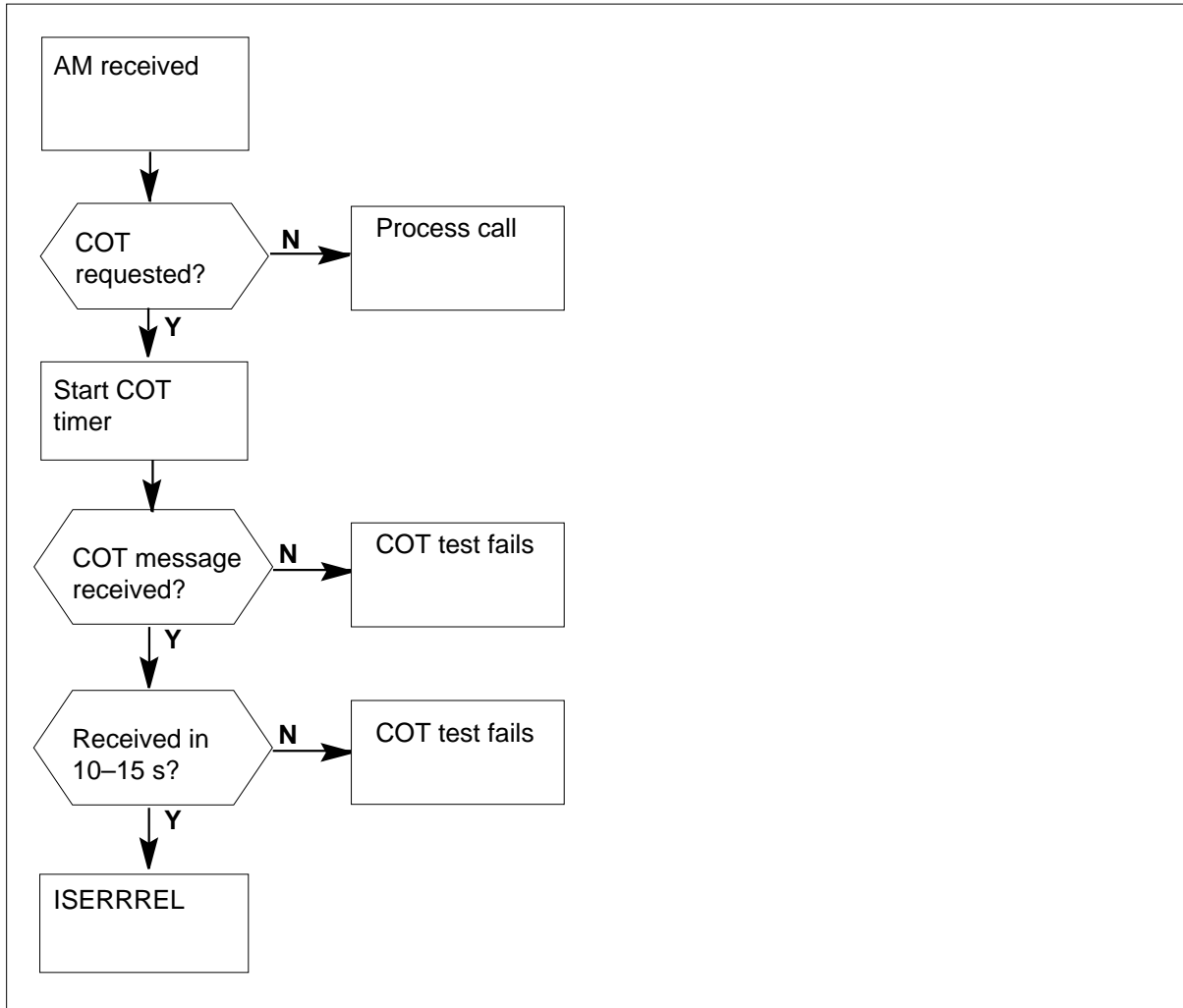

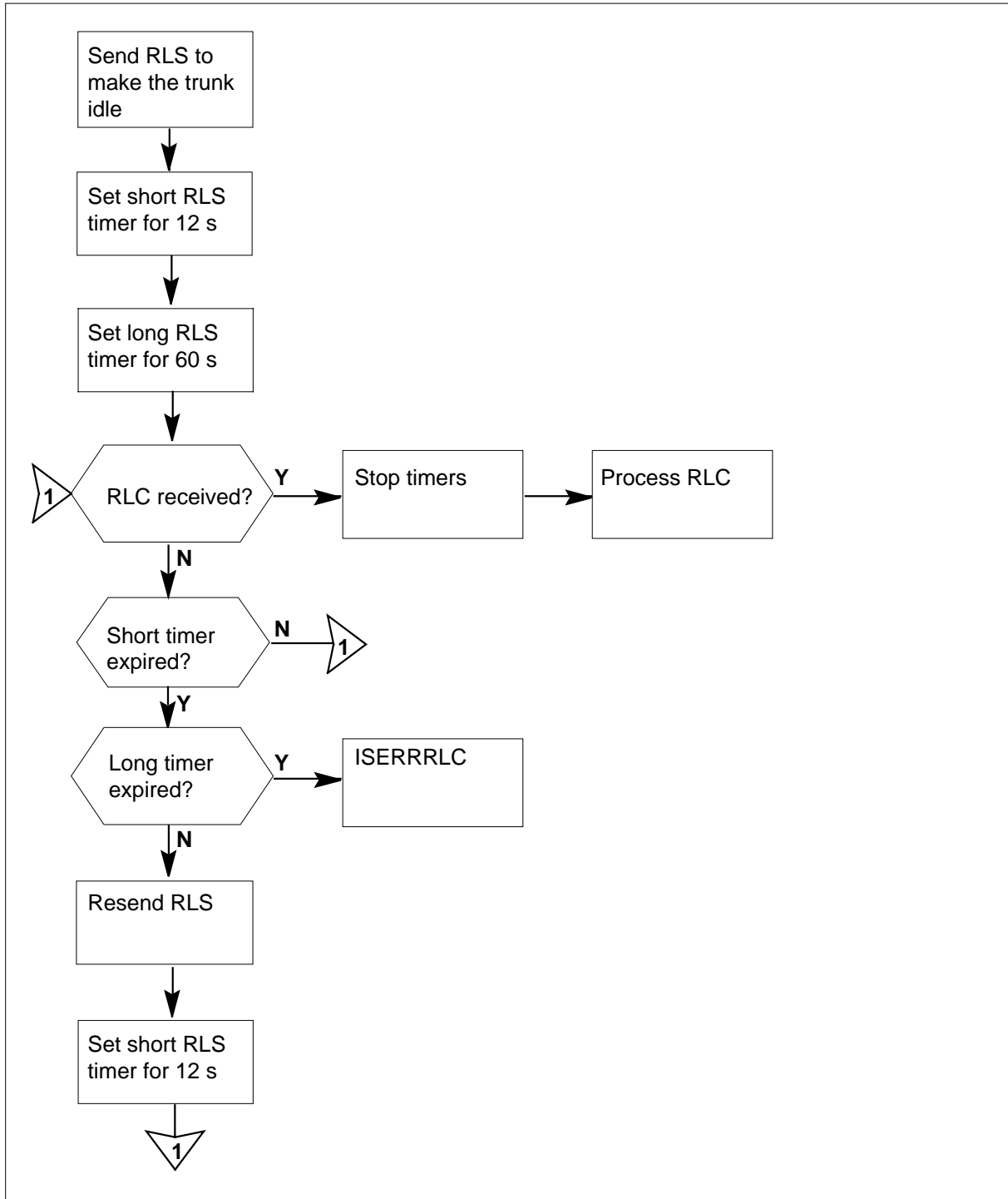
OM group ISUPERRS (continued)**OM group ISUPERRS RLC message sent**

OM group ISUPERRS (continued)

OM group ISUPERRS - inappropriate messages (continued)

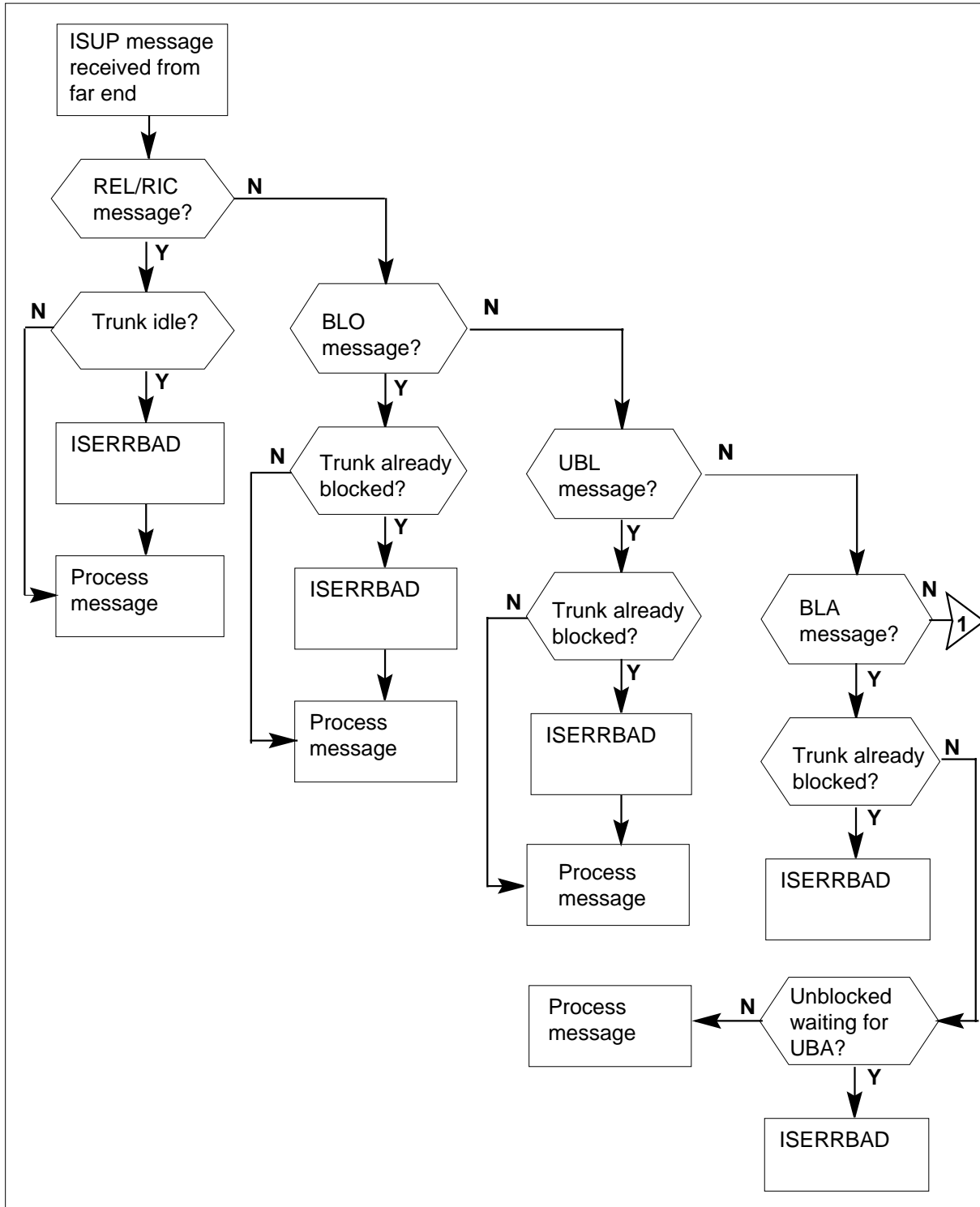

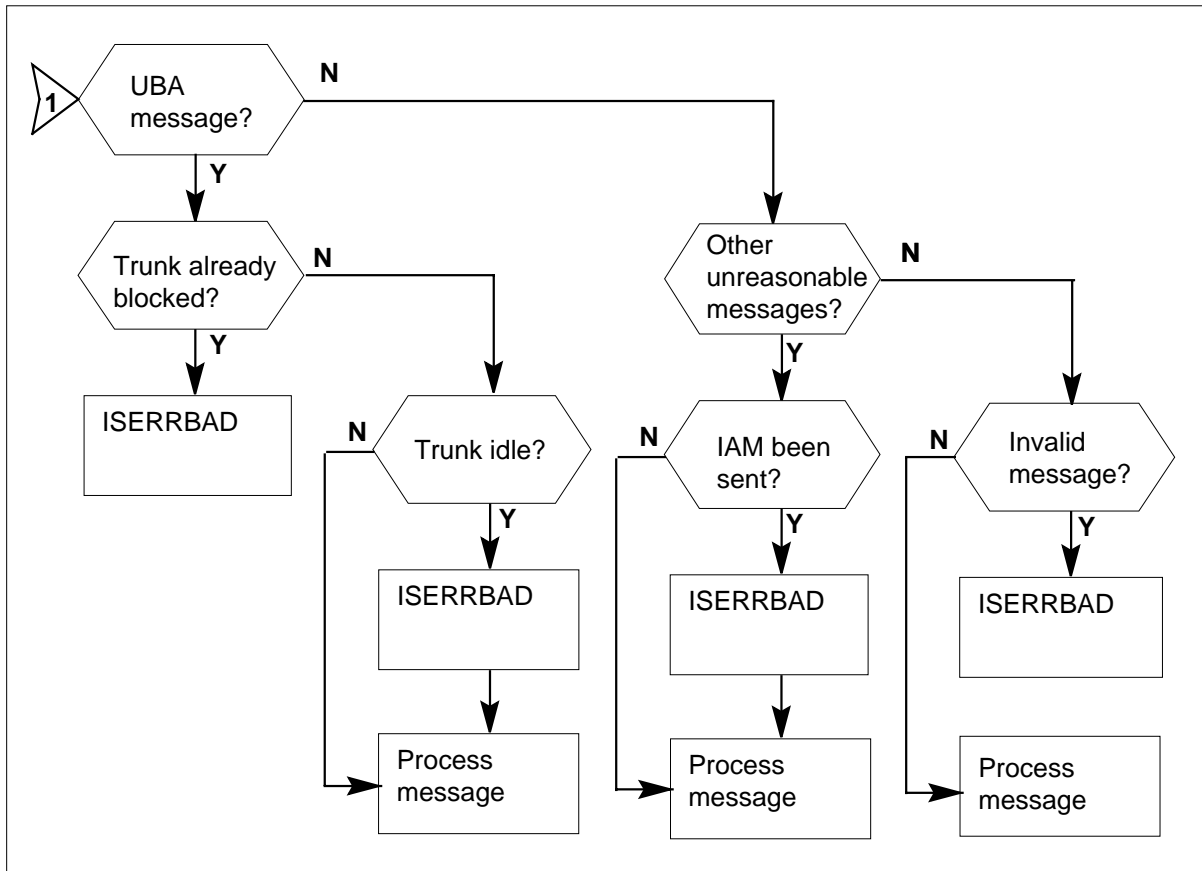
OM group ISUPERRS (continued)**OM group ISUPERRS - inappropriate messages (continued)**

OM group ISUPERRS (continued)

OM group ISUPERRS - RSC message sent

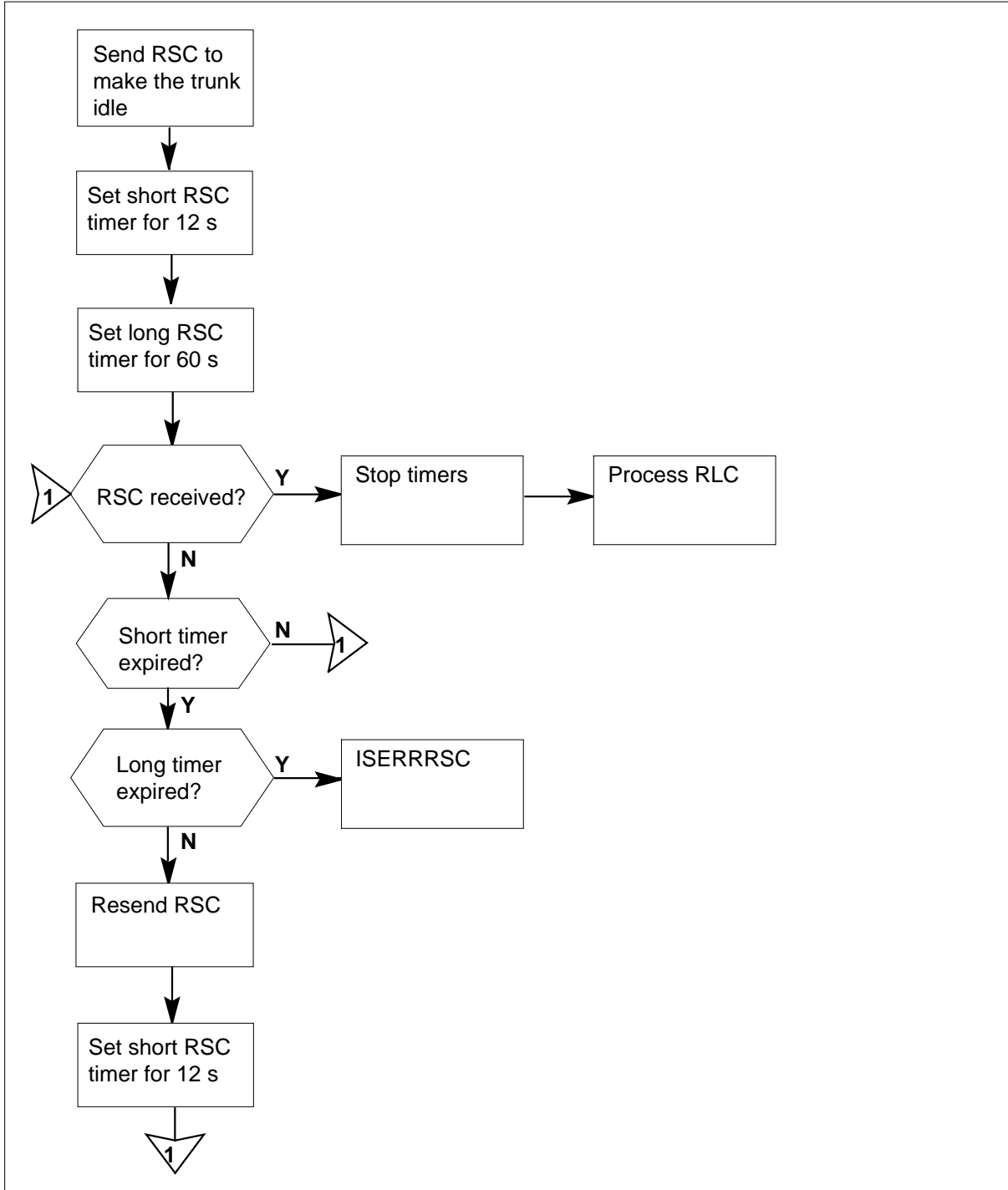

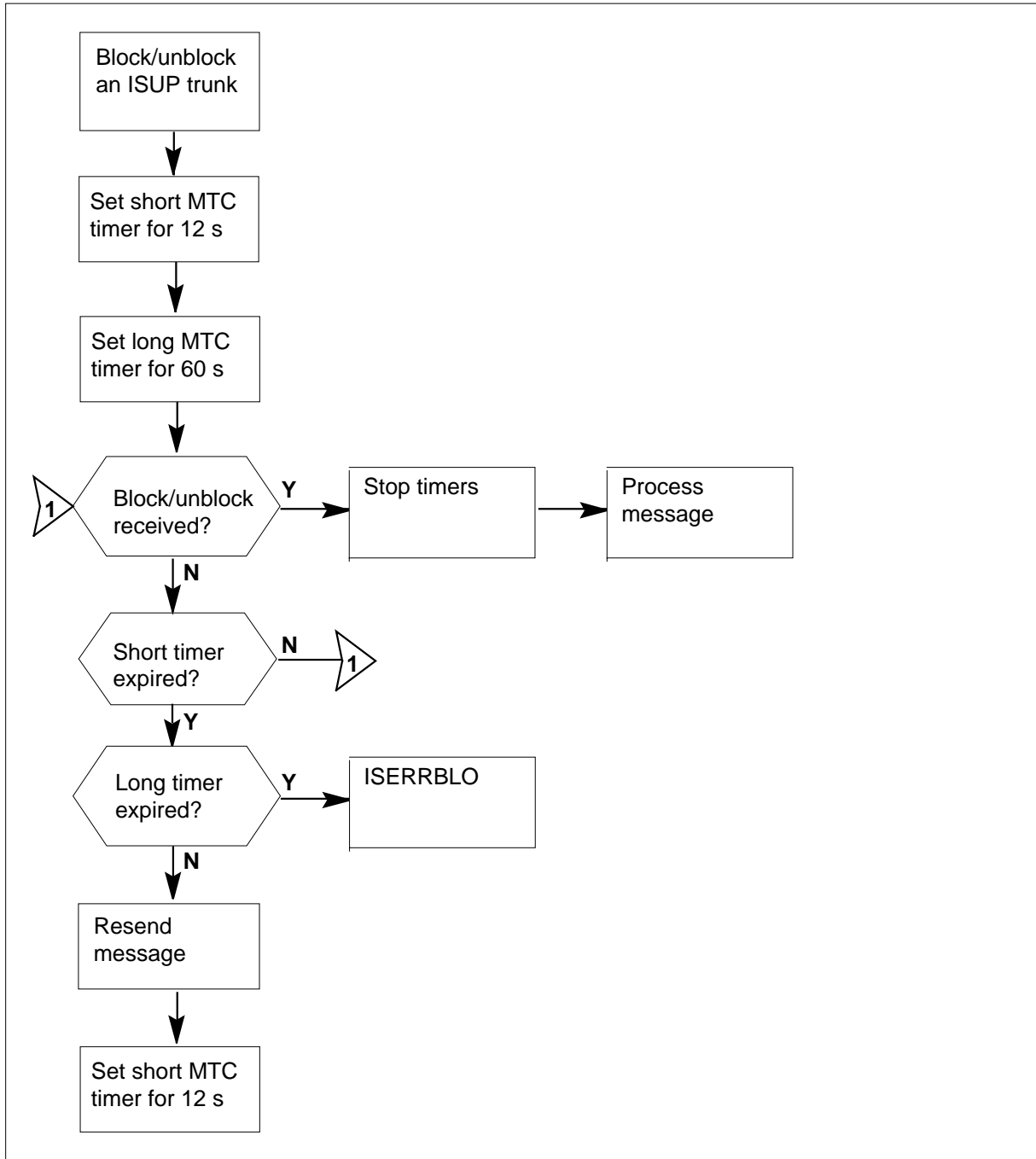
OM group ISUPERRS (continued)**OM group ISUPERRS - block/unblock message sent**

OM group ISUPERRS (continued)

OM group ISUPERRS - GRS message sent

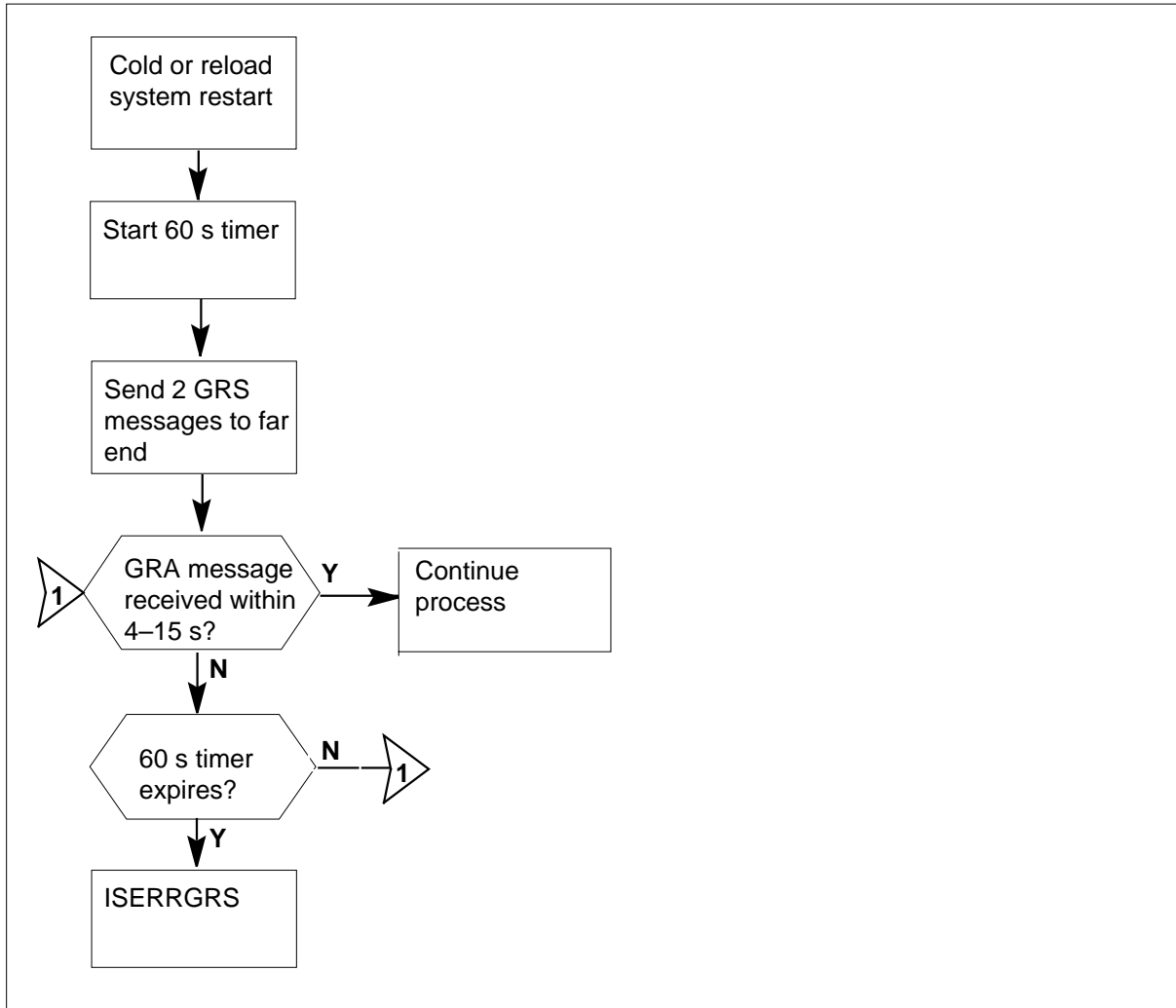

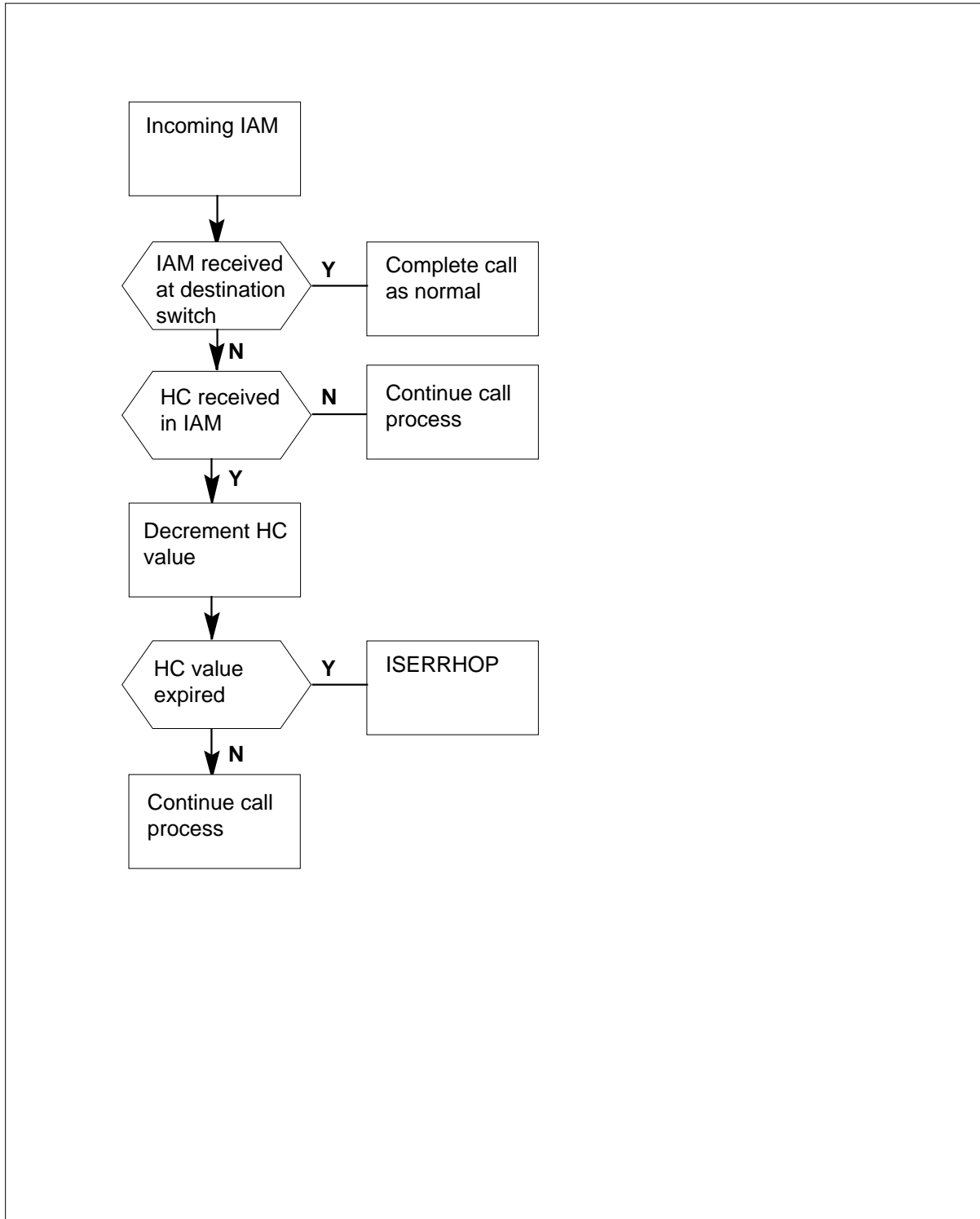
OM group ISUPERRS (continued)**OM group ISUPERRS - expiration of the ISUP hop counter parameter value**

OM group ISUPERRS (continued)

Register ISERRBAD

ISDN error bad

ISDN error bad (ISERRBAD) counts messages received in inappropriate situations, such as the following:

- RLS or RLC messages received on an idle circuit
- blocking messages received for a blocked circuit
- unblocking messages received for an unblocked circuit
- blocking acknowledgement messages received unexpectedly
- unblocking acknowledgement messages received unexpectedly
- other unreasonable messages received after the initial address message has been sent
- invalid messages

Register ISERRBAD release history

ISERRBAD was introduced in BCS26.

Associated registers

None

Associated logs

C7UP101 is generated when an unreasonable report is received in a trunk, except when unreasonable messages are received on an idle circuit.

Extension registers

None

Register ISERRBLO

ISUP error blocking message

The ISUP error blocking message (ISERRBLO) register is incremented when an acknowledgement message is not received within one minute of sending blocking/unblocking messages at 4- to 15-second intervals. Message intervals during the 1-minute period are determined by the blocking/unblocking maintenance timer. The register is incremented at the end of the 1-minute period.

Register ISERRBLO release history

ISERRBLO was introduced in BCS26.

OM group ISUPERRS (continued)

Associated registers

None

Associated logs

C7UP100 is generated when no acknowledgement message is received from the far-end office in response to an RSC, circuit group reset (GRS), blockage or unblockage, or RLS message.

Extension registers

None

Register ISERRGRS

ISUP error circuit group reset (GRS)

The ISUP error circuit group reset (GRS) (ISERRGRS) register is incremented when a GRS acknowledgement (GRA) message is not received within one minute of sending a pair of GRS messages.

GRS messages originate from the DMS switch only after cold and reload system restarts.

Register ISERRGRS release history

ISERRGRS was introduced in BCS26.

Associated registers

None

Associated logs

C7UP100 is generated when an acknowledgement message is received from the far-end office in response to an RSC, GRS, blockage or unblockage, or RLS message.

Extension registers

None

Register ISERRHOP

ISDN HOP counter expiry

ISERRHOP is pegged every time a hop counter (HC) parameter in the incoming initial address message (IAM) expires.

Register ISERRHOP release history

ISERRHOP was introduced in the NA005 release.

OM group ISUPERRS (continued)

Associated registers

None

Associated logs

A C7UP130 log is generated when the HC parameter expiration is detected.

Extension registers

None

Register ISERRREL

ISDN error release (RLS) message

The ISDN error release (RLS) message (ISERRREL) register counts circuits that are released in outgoing offices because of the following abnormal conditions:

- no address complete message (ACM) received within 20 to 30 seconds of an initial address message sent by this office
- RLS message received after an ACM and before an answer message

The register also counts circuits released in incoming offices because no continuity message (if applicable) is received at the incoming office after receipt of the initial address message.

All abnormal conditions listed above cause the release of circuits in transit offices because they are both incoming and outgoing offices.

Register ISERRREL release history

ISERRREL was introduced in BCS26.

BCS32

Register ISERRREL is incremented by the ISUP-to-TUP Interworking feature.

BCS30

Register ISERRREL counts calls between BTUP trunks and TUP+ trunks, as well as between T101 test lines and BTUP, TUP, and TUP+ trunks.

Associated registers

None

OM group ISUPERRS (end)

Associated logs

C7UP102 is generated when a CCS7 connection is released because of an abnormal condition, except when an RLS message is received instead of an answer message.

Extension registers

None

OM group ISUPUSAG

OM description

The integrated services user part utilization

The ISUPUSAG counts incoming and outgoing messages that use ISDN user part (ISUP), based on message types defined in the following standards:

- American National Standard T1.113.2 - 1987- ISUP Message Acronyms
- ITU Q.763
- ETS 300 356-1

The system counts outgoing call processing messages in the digital trunk controller for SS7 (DTC7) and the NA100 Spectrum Peripheral Module (SPM) product. The system counts outgoing maintenance messages in the central control complex (CCC). The system counts incoming call processing and maintenance messages in the message switch and buffer SS7 (MSB7). The system also counts these messages in the link interface unit SS7 (LIU7).

The ISUPUSAG monitors message volume to determine ISUP performance, activity, and stability.

Note: In GL04, OM group ISUPUSAG increases for ISUP and TUP.

Release history

NA011

Added reference to the NA100 SPM product.

GL04

The OM group ISUPUSAG was introduced in GL04.

EUR006

The ETSI ISUP V2 support adds nine new tuples to this OM group. This support increases the maximum number of tuples to 62.

BCS28

Six key fields (ALT, CRG, PRG, CRM, CRA, IAMN1) were added.

BCS27

A new key field for ISUP call progress messages (CPG) was added.

OM group ISUPUSAG was introduced in BCS26.

OM group ISUPUSAG (continued)

Registers

OM group ISUPUSAG registers display on the MAP terminal as follows:

ISMSGOUT ISMSGOT2 ISMSGIN ISMSGIN2

Group structure

OM group ISUPUSAG provides one tuple for each ISUP message acronym.

Key field:

ISUPOM_MSG_TYPE:

OM group ISUPUSAG (continued)

The following acronyms are counted in ISUPUSAG and are specified in the following standards:

- American National Standard T1.113.2 D 1987- ISUP Message Acronyms
- ETSI (ETS 300 356-1)
- International (ITU Q.763)

ACM:

address complete

ALT:

alerting message

ANM:

answer

BLA:

blocking acknowledgment

BLO:

blocking

CCR:

continuity check request

CFN:

Confusion

CGB:

circuit group blocking

CGBA:

circuit group blocking acknowledgment

CGU:

circuit group unblocking

CGUA:

circuit group unblocking acknowledgment

CMC:

call modification completed

CMRJ:

call modification rejected

CMR:

call modification request

CON:

connect

COT:

OM group ISUPUSAG (continued)

continuity

CPG:

call progress message

CQM:

circuit query

CQR:

circuit query response

CRA:

circuit reservation acknowledgment

CRG:

charge information

CRM:

circuit reservation

CSVR:

closed user group selection and validation request

CSVS:

closed user group selection and validation response

CVR:

circuit validation response

CVT:

circuit validation test

DRS:

delayed release

EXM:

exit

FAA:

facility accepted

FAC:

facility

FAD:

facility deactivated

FAI:

facility information

FAR:

facility request

FRJ:

OM group ISUPUSAG (continued)

facility reject

FOT:

forward transfer

GRA:

circuit group reset acknowledgment

GRS:

circuit group reset

IAM:

initial address message

IAMN1:

initial address message not priority one

IDR:

identification request

INF:

information

INR:

information request

IRS:

identification response

LOP:

loop prevention

LPA:

loop back acknowledgment

NRM:

network resource management

PAM:

pass along message

PRG:

progress

REL:

release

RES:

resume

RLC:

release complete

RPM:

OM group ISUPUSAG (continued)

reconfiguration progress message (also counts OLM:Overload)

RSC:

reset circuit

SAM:

subsequent address message

SGM:

segmentation

SUS:

suspend

UBA:

unblocking acknowledgment

UBL:

unblocking

UCIC:

unequipped circuit identification code

UPA:

user part available

UPT:

user part test

USR:

user-to-user information

Info field:

There is no info field.

The maximum number of keys is 62.

Associated OM groups

The ISUPCGRP provides information on circuit availability for each trunk group.

The SUPCKTA counts circuit and circuit group blocking and unblocking messages sent between local and far-end offices.

The ISUPCONN counts call attempts that are not complete.

ISUPERRS counts not normal conditions, not planned messages, and the absence of acknowledgment messages during call setup and call takedown.

OM group ISUPUSAG (continued)

Associated functional groups

The following switched groups associate with OM group ISUPUSAG:

- ISDN
- ISUP
- CCS7

Associated functionality codes

The functionality codes that associate with OM group ISUPUSAG appear in the following table.

Functionality	Code
ISUP Operational Measurements	NTX167AB
Network Number Display	NTXA35AA
SPMS SHR	SPMS0001

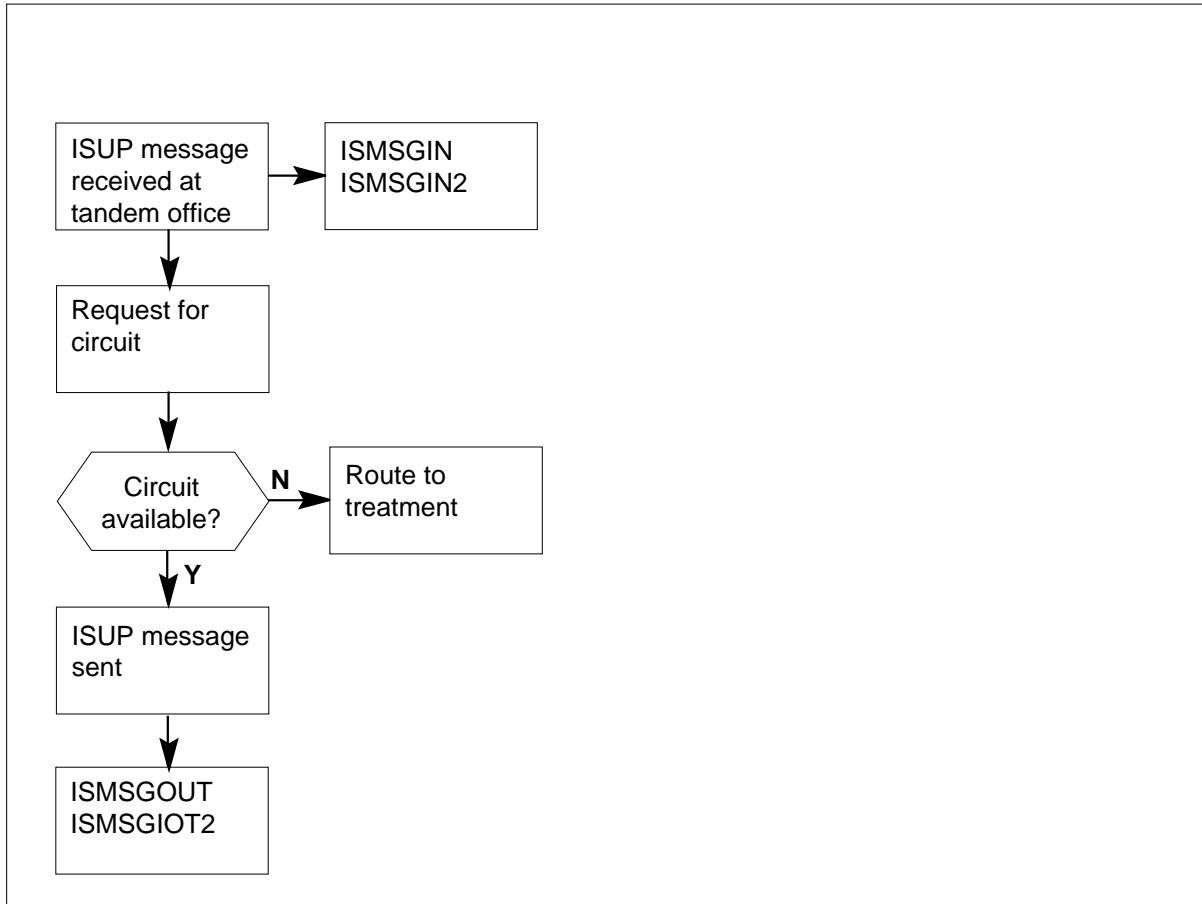
OM group ISUPUSAG (continued)**OM group ISUPUSAG registers****Register ISMSGIN**

The integrated services digital network user part messages incoming

The ISMSGIN counts ISUP messages the office receives. These messages include incoming messages that pass through a move (tandem) office. Count each type of incoming ISUP message separately.

These measurements collect in the link interface unit for SS7 (LIU7). The system sends these messages to the central control complex (CCC) when at least one count reaches the maximum value of 65535.

Measurements also collect in the message switch and buffer for SS7 (MSB7). The system sends messages to the central control complex (CCC) every 15 s. The system also sends messages to the CCC when at least one count reaches the maximum value of 255.

OM group ISUPUSAG (end)

Register ISMSGIN release history

The ISMSGIN was introduced in BCS26.

Associated registers

There are no associated registers.

Associated logs

There are no associated logs.

Extension registers

ISMSGIN2

Register ISMSGOUT

The integrated services digital network user part messages outgoing

Register ISMSGOUT counts ISUP messages sent from an office, including messages that pass through a move (tandem) office. Count each type of ISUP message separately. Count maintenance messages in the central control complex (CCC). Outgoing call processing messages are collected in the digital trunk controller (DTC) and sent to the CC. At least one count reaches the maximum value of 255.

Register ISMSGOUT release history

Register ISMSGOUT was introduced in BCS26.

Associated registers

There are no associated registers.

Associated logs

There are no associated logs.

Extension registers

ISMSGOT2

OM group LIDBCCV

OM description

Line information database calling card information (LIDBCCV) provides access to verify calling card numbers. The registers track the performance of the access by counting the number of queries and responses and classifying responses as valid access or invalid access.

LIDBCCV contains 21 registers that count the following activities:

- the number of LEC calls and/or LEC validation attempts being processed, regardless of the outcome of the call or validation
- the number of queries sent to LIDB to validate the calling card number
- the number of responses received from the CCS7 network with respect to a launched query
- the number of positive responses from the LIDB to validate the calling card number
- the number of queries that were abandoned
- the number of responses that reply with the reason "no PINS" assigned
- the number of responses that reply with the reason "calling card denial"
- the number of responses that reply with a valid response with an unrestricted PIN
- the number of responses that reply with a valid response with restricted PIN
- the number of responses that reply with a response of "threshold exceeded on PIN"
- the number of responses that reply with a response of nonpayment
- the number of messages that are returned due to unexpected component sequence
- the number of responses that indicate an unexpected data value was found (no PIN match)
- the number of messages that were returned due to unavailable network resources
- the number of responses that were returned due to a missing customer record
- the number of responses that were returned due to data unavailable
- the number of times the process waiting for the response times out
- the number of errors not specifically mentioned

OM group LIDBCCV (continued)

- the number of times that the query could not be processed due to a database failure or congestion
- the number of times a query was returned due to an SCCP Global Title Translation failure
- the number of times a query could not be sent due to Automatic Code Gapping

Release history

OM group LIDBCCV was introduced in BCS 31.

Registers

The following OM group LIDBCCV registers display on the MAP terminal as follows:

LIDBTOT	LIDBTOTQ	LIDBTOTR	LIDBRPOS
LIDBANQY	LIDBNOPN	LIDBCCDN	LIDBPUN
LIDBPRE	LIDBTHR	LIDBNPAY	LIDBCOMP
LIDBDATA	LIDBNETR	LIDBMREC	LIDBUNAV
LIDBTMO	LIDBMISC	LIDBDBFC	LIDBSPTR
LIDBACGF			

Group structure

OM group LIDBCCV provides one tuple per office.

Key field:

None

Info field:

None

Associated OM groups

None

Associated functional groups

None

Associated functionality codes

None

OM group LIDBCCV (continued)

OM group LIDBCCV (continued)

OM group LIDBCCV registers

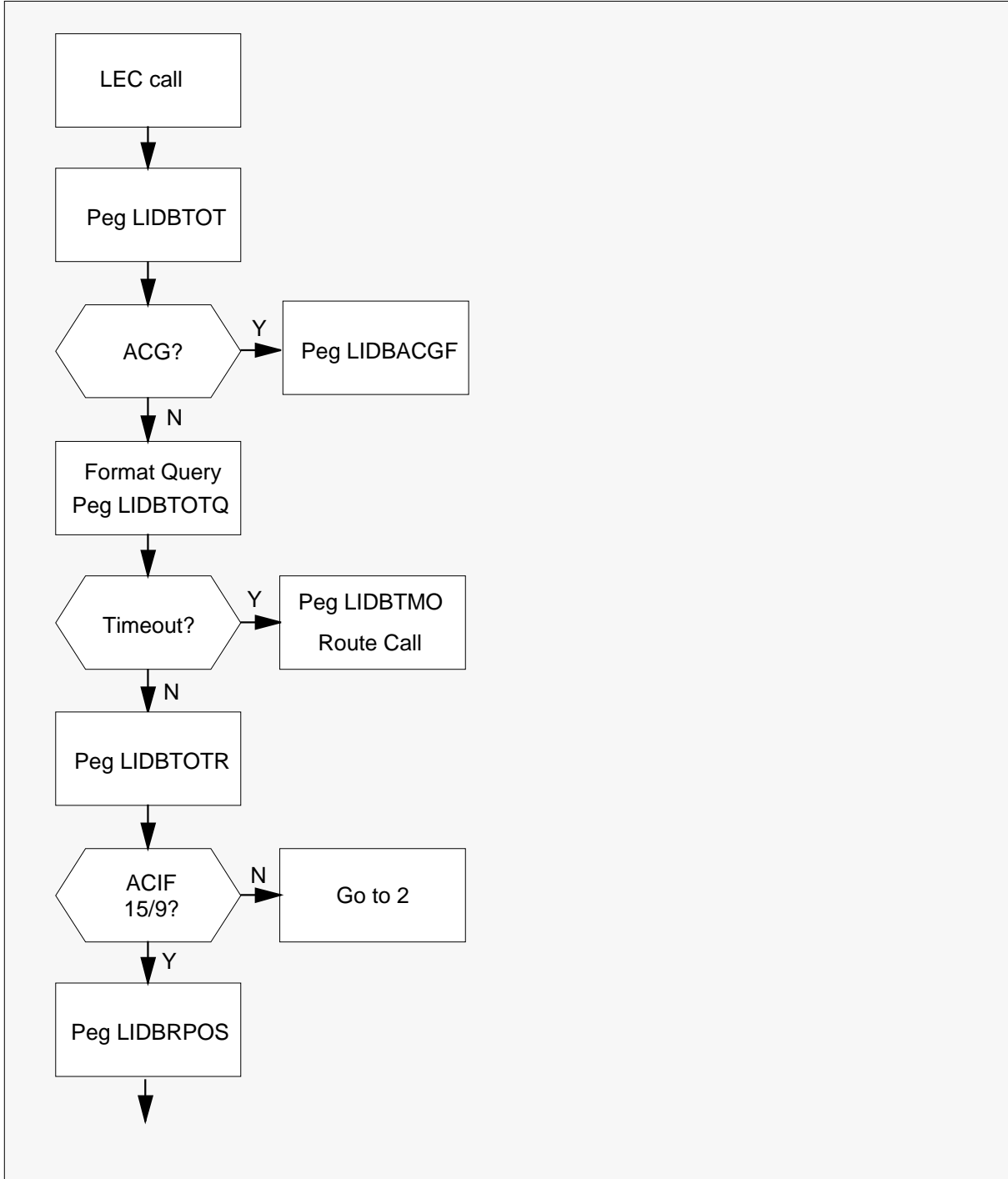

OM group LIDBCCV (continued)

OM group LIDBCCV (continued)

OM group LIDBCCV registers (continued)

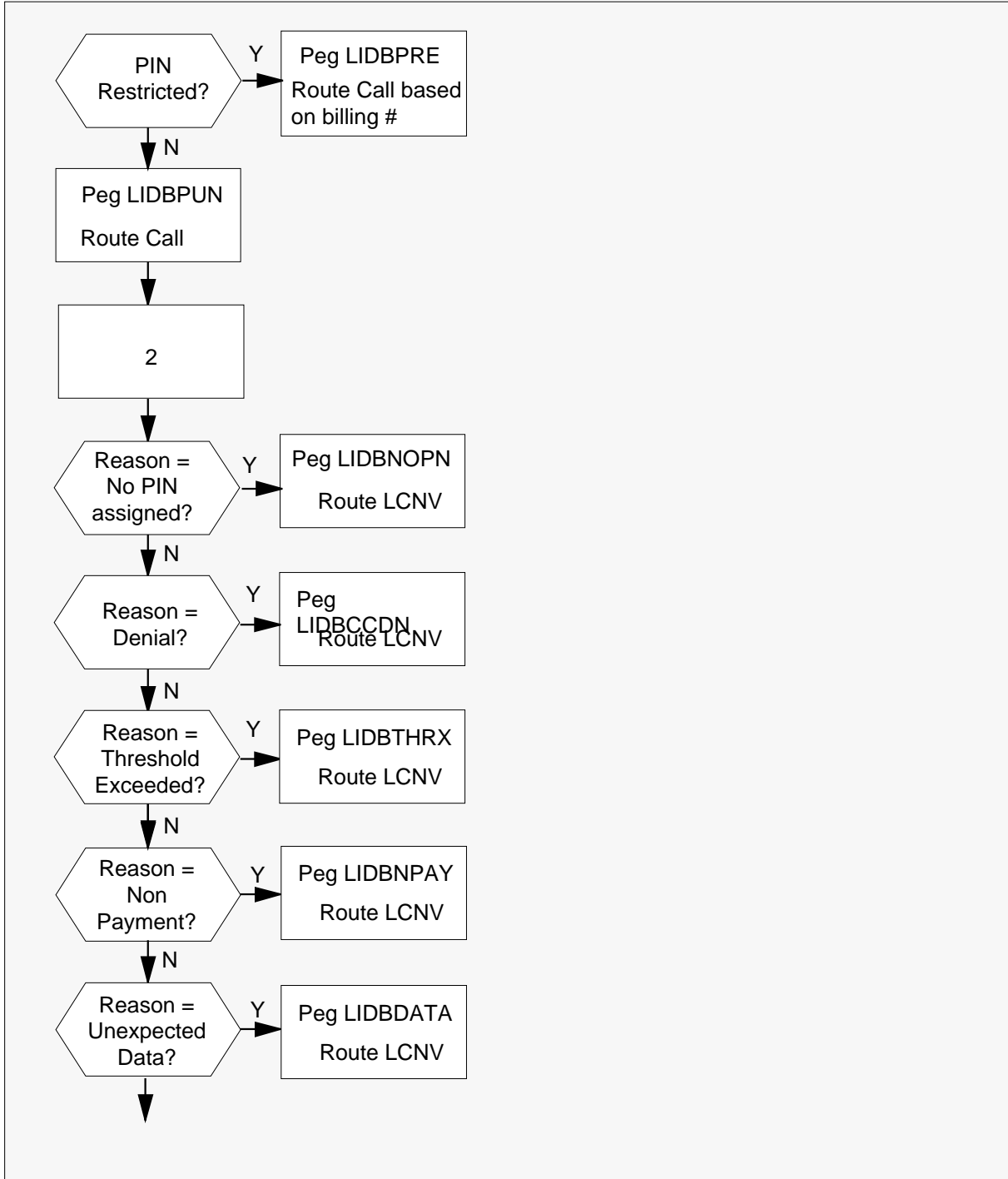

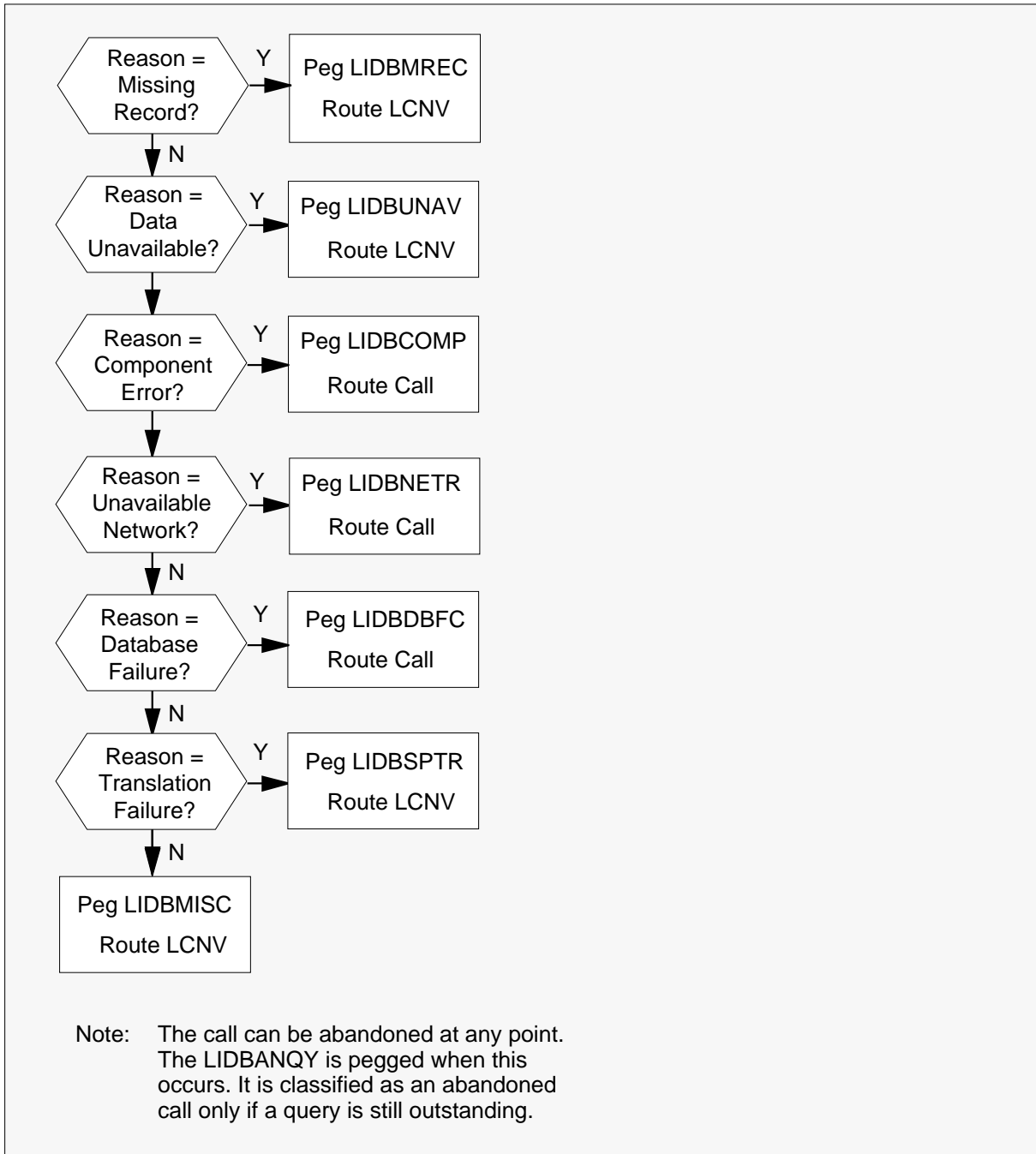
OM group LIDBCCV (continued)**OM group LIDBCCV registers (continued)**

OM group LIDBCCV (continued)

Register LIDBTOT

Register LIDB Total Calls

LIDB Total Calls (LIDBTOT) counts the number of LEC calls and/or LEC validation attempts being processed by the office, regardless of the outcome of the call or validation.

Register LIDBTOT release history

Register LIDBTOT was introduced in BCS31.

Associated registers

Register LIDBTOT is associated with registers LIDBTOTQ and LIDBACGF as expressed in the following formula: $LIDBTOT = LIDBTOTQ + LIDBACGF$

Associated logs

None

Extension registers

None

Register LIDBTOTQ

Register LIDB Total Queries

LIDB Total Queries (LIDBTOTQ) counts the number of queries launched to LIDB to validate the calling card number.

Register LIDBTOTQ release history

Register LIDBTOTQ was introduced in BCS31.

Associated registers

Register LIDBTOTQ is associated with registers LIDBTOT and LIDBACGF as expressed in the following formula: $LIDBTOT = LIDBTOTQ + LIDBACGF$

Associated logs

None

Extension registers

None

Register LIDBTOTR

Register LIDB Total Responses

OM group LIDBCCV (continued)

LIDB Total Responses (LIDBTOTR) counts the number of responses received from the CCS7 network with respect to the launched query.

Register LIDBTOTR release history

Register LIDBTOTR was introduced in BCS31.

Associated registers

Register LIDBTOTR is associated with several registers as expressed in the following formula:

$$\text{LIDBTOTR} = \text{LIDBRPOS} + \text{LIDBNOPN} + \text{LIDBCCDN} + \text{LIDBTHR} + \text{LIDBNPAY} + \text{LIDBCOMP} + \text{LIDBDATA} + \text{LIDBNETR} + \text{LIDBMREC} + \text{LIDBUNAN} + \text{LIDBMISC} + \text{LIDBDBFC} + \text{LIDBSPTR} - \text{LIDBANQY} - \text{LIDBTMO}$$
Associated logs

None

Extension registers

None

Register LIDBRPOS

Register LIDB Responses Positive

LIDB Responses Positive (LIDBRPOS) counts the number of positive responses from the LIDB to validate the calling card number.

Register LIDBRPOS release history

Register LIDBRPOS was introduced in BCS31.

Associated registers

The register association is described by the formula for LIDBTOTR

Associated logs

None

Extension registers

None

Register LIDBANQY

Register LIDB Abandon Query

LIDB Abandon Query (LIDBANQY) counts the number of queries that were abandoned.

OM group LIDBCCV (continued)

Register LIDBANQY release history

Register LIDBANQY was introduced in BCS31.

Associated registers

The register association is described by the formula for LIDBTOTR

Associated logs

None

Extension registers

None

Register LIDBNOPN

Register LIDB No PIN Found

LIDB No PIN Found (LIDBNOPN) counts the number of responses that reply with the reason "no PINs assigned."

Register LIDBNOPN release history

Register LIDBNOPN was introduced in BCS31.

Associated registers

The register association is described by the formula for LIDBTOTR

Associated logs

None

Extension registers

None

Register LIDBCCDN

Register LIDB Calling Card Denial

LIDB Calling Card Denial (LIDBCCDN) counts the number of responses that reply with the reason "calling card denial."

Register LIDBCCDN release history

Register LIDBCCDN was introduced in BCS31.

Associated registers

The register association is described by the formula for LIDBTOTR

OM group LIDBCCV (continued)

Associated logs

None

Extension registers

None

Register LIDBPUN

Register LIDB PIN Unrestricted

LIDB PIN Unrestricted (LIDBPUN) counts the number of responses that reply with a valid response with an unrestricted PIN.

Register LIDBPUN release history

Register LIDBPUN was introduced in BCS31.

Associated registers

The register association is described by the formula for LIDBRPOS.

Associated logs

None

Extension registers

None

Register LIDBPRE

Register LIDB PIN Restricted

LIDB PIN Restricted (LIDBPRE) counts the number of responses that reply with a valid response with a restricted PIN.

Register LIDBPRE release history

Register LIDBPRE was introduced in BCS31.

Associated registers

The register association is described by the formula for LIDBRPOS.

Associated logs

None

Extension registers

None

OM group LIDBCCV (continued)

Register LIDBTHRX

Register LIDB Threshold Exceeded

LIDB Threshold Exceeded (LIDBTHRX) counts the number of responses that reply with a response of "threshold exceeded on PIN."

Register LIDBTHRX release history

Register LIDBTHRX was introduced in BCS31.

Associated registers

The register association is described by the formula for LIDBTOTR.

Associated logs

None

Extension registers

None

Register LIDBNPAY

Register LIDB No Payment

LIDB No Payment (LIDBNPAY) counts the number of responses that reply with a response of "nonpayment."

Register LIDBNPAY release history

Register LIDBNPAY was introduced in BCS31.

Associated registers

The register association is described by the formula for LIDBTOTR.

Associated logs

None

Extension registers

None

Register LIDBCOMP

Register LIDB Invalid Component

LIDB Invalid Component (LIDBCOMP) counts the number of messages that are returned due to an unexpected component sequence.

OM group LIDBCCV (continued)

Register LIDBCOMP release history

Register LIDBCOMP was introduced in BCS31.

Associated registers

The register association is described by the formula for LIDBTOTR.

Associated logs

None

Extension registers

None

Register LIDBDATA

Register LIDB Unexpected Data (No PIN match)

LIDB Unexpected Data (LIDBDATA) counts the number of responses that indicate an unexpected data value was found (no PIN match).

Register LIDBDATA release history

Register LIDBDATA was introduced in BCS31.

Associated registers

The register association is described by the formula for LIDBTOTR.

Associated logs

None

Extension registers

None

Register LIDBNETR

Register LIDB Unavailable Network Resources

LIDB Unavailable Network Resources (LIDBNETR) counts the number of messages that were returned due to unavailable network resources.

Register LIDBDNETR release history

Register LIDBNETR was introduced in BCS31.

Associated registers

The register association is described by the formula for LIDBTOTR.

OM group LIDBCCV (continued)

Associated logs

None

Extension registers

None

Register LIDBMREC

Register LIDB Missing Record

LIDB Missing Record (LIDBMREC) counts the number of responses that were returned due to a missing customer record.

Register LIDBDMREC release history

Register LIDBMREC was introduced in BCS31.

Associated registers

The register association is described by the formula for LIDBTOTR.

Associated logs

None

Extension registers

None

Register LIDBUNAV

Register LIDB Data Unavailable

LIDB Data Unavailable (LIDBUNAV) counts the number of responses that were returned due to data unavailable.

Register LIDBDUNAV release history

Register LIDBUNAV was introduced in BCS31.

Associated registers

The register association is described by the formula for LIDBTOTR.

Associated logs

None

Extension registers

None

OM group LIDBCCV (continued)

Register LIDBTMO

Register LIDB Time Out

LIDB Time Out (LIDBTMO) counts the number of times the process waiting for the response timed out.

Register LIDBDTMO release history

Register LIDBTMO was introduced in BCS31.

Associated registers

The register association is described by the formula for LIDBTOTR.

Associated logs

None

Extension registers

None

Register LIDBMISC

Register LIDB Miscellaneous

LIDB Miscellaneous (LIDBMISC) accumulates all the errors nor specifically mentioned.

Register LIDBDMISC release history

Register LIDBMISC was introduced in BCS31.

Associated registers

The register association is described by the formula for LIDBTOTR.

Associated logs

None

Extension registers

None

Register LIDBDBFC

Register LIDB Database Failure

LIDB Database Failure (LIDBDBFC) counts the number of times that the query could not be processed due to a database failure or congestion.

OM group LIDBCCV (continued)

Register LIDBDBFC release history

Register LIDBDBFC was introduced in BCS31.

Associated registers

The register association is described by the formula for LIDBTOTR.

Associated logs

None

Extension registers

None

Register LIDBSPTR

Register LIDB SCCP Translation Failure

LIDB SCCP Translation Failure (LIDBSPTR) counts the number of times a query was returned due to an SCCP Global Title Translation failure.

Register LIDBSPTR release history

Register LIDBSPTR was introduced in BCS31.

Associated registers

The register association is described by the formula for LIDBTOTR.

Associated logs

None

Extension registers

None

Register LIDBACGF

Register LIDB Automatic Code Gap Failure

LIDB Automatic Code Gap Failure (LIDBACGF) counts the number of times a query could not be sent due to Automatic Code Gapping.

Register LIDBACGF release history

Register LIDBACGF was introduced in BCS31.

Associated registers

The register association is described by the formula for LIDBTOT.

OM group LIDBCCV (end)

Associated logs

None

Extension registers

None

OM group LMD

OM description

Line traffic

The OM group LMD provides traffic information for the following peripheral modules (PM):

- remote line modules (RLM)
- line concentrating modules (LCM)
- virtual line concentrating modules (VLCM)
- remote concentrator terminals (RCT)
- remote concentrator subscribers (RCS)
- integrated services line modules (ISLM)
- digital line modules (DLM)
- very small remotes (VSR)
- enhanced line concentrating modules (ELCM)
- integrated services digital network (ISDN) line concentrating modules (LCMI)
- intelligent peripheral equipment (IPE)
- line modules (LM)

ISUPCGRP counts available circuits for each trunk.

ISUPCONN counts call attempts that are not complete.

One use register records the number of busy lines.

Ten registers count the following:

- attempts to find a speech link from the network module to a terminating line
- attempts to find a speech link that fail
- originating call attempts
- originating call attempts that fail
- originating call attempts that the subscriber abandons
- attempts to terminate on a line that fail
- attempts to collect or return coins that fail

OM group LMD (continued)

- revertive call attempts
- Multiple Appearance Directory Number (MADN) group secondary units that are notified of an incoming call

All types of DMS offices have LMD.

Release history

OM group LMD introduced before BCS20

APC009

Virtual line concentrating module (VLCM) added to OM description and group structure.

GL04

Registers MADNTATT, REVERT and STKCOINS do not increase.

BCS35

The info field includes the ADNUM field. The ADNUM field contains a different unit number that identifies each peripheral module.

BCS33

Register LMTRU can convert from CCS to deci-erlangs before display. Use the OMSHOW command on the ACTIVE class to perform this conversion.

BCS32

LMD includes traffic measurements for the lines associated with the remote digital terminal.

BCS31

One tuple for each IPE module on an SL-100 that LMD provides.

BCS24

One tuple for each ELCM and LCMI that LMD provides

BCS23

One tuple for each VSR that LMD provides.

BCS21

One tuple for each DLM that LMD provides.

BCS20

Software change provides use registers in CCS or in deci-erlangs, and one tuple for each ISLM that LMD provides.

OM group LMD (continued)

Registers

OM group LMD registers appear on the MAP terminal as follows:

NTERMATT	NORIGATT	LMTRU	TERMBLK
ORIGFAIL	PERCLFL	STKCOINS	REVERT
MADNTATT	ORIGBLK	ORIGABN	

Group structure

OM group LMD can provide one tuple for each line peripheral.

Key field:

There is no key field.

Info field:

LMD_OMINFO is the PM identifier.

The PM identifier contains the site identifier, the frame number, and the unit number. The site identifier is four alphanumeric characters. For ISLM, the site identifier must be HOST. The frame number is a number from 0-511. Unit numbers appear according to PM type in the following list:

- ALCM 0-1
- DLM 0-1
- ELCM 0-1
- FRU 0-1
- IPE 0-3
- ISLM 0-3
- LCM 0-1
- LCME 0-1
- LCMI 0-1
- LDT 0
- LM 0-1
- LRU 0-9
- RCS 0-9
- RCT 0-9
- RCU 0-9

OM group LMD (continued)

- RDT 0-9
- VLCM 0-1

Associated OM groups

The OM group OFZ monitors office-wide traffic. The OFZ registers count calls based on the source of the call and the intended destination.

The OM group OTS monitors office-wide traffic. OTS registers count calls based on the source of the call and the accurate destination.

Associated functional groups

There are no associated functional groups.

Associated functionality codes

The associated functionality codes for OM group LMD are in the table:

Functionality	Code
Meridian SL-100 Cabinetized Software	NTXA10AA
Extended Peripheral Equipment	NTXN25AA
Common Basic	NTX001AA
Digital Telephone M2000-Basic	NTX640AA
OMs in Erlangs	NTX664AA
ISDN Basic Access	NTX750AB

OM group LMD (continued)

OM group LMD registers

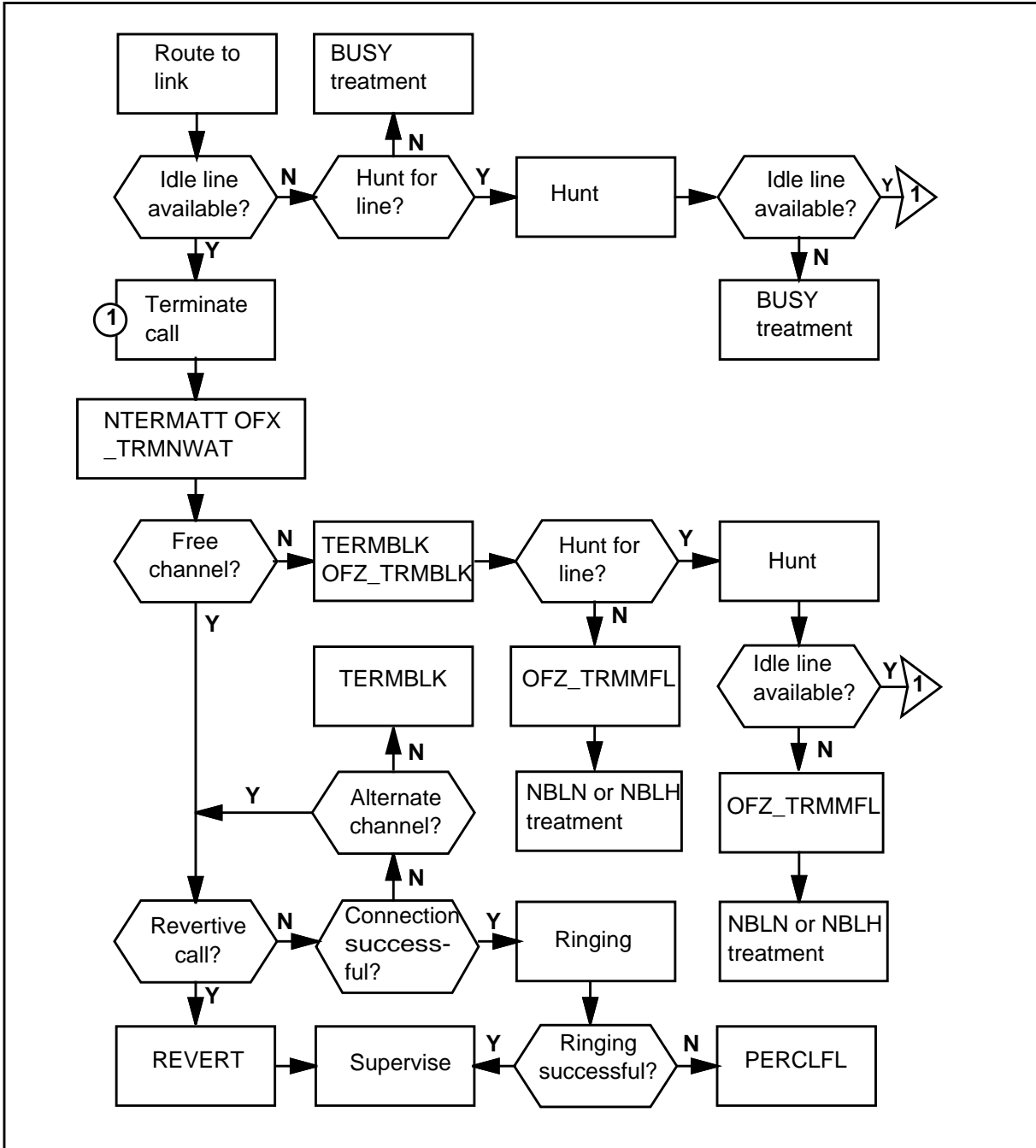

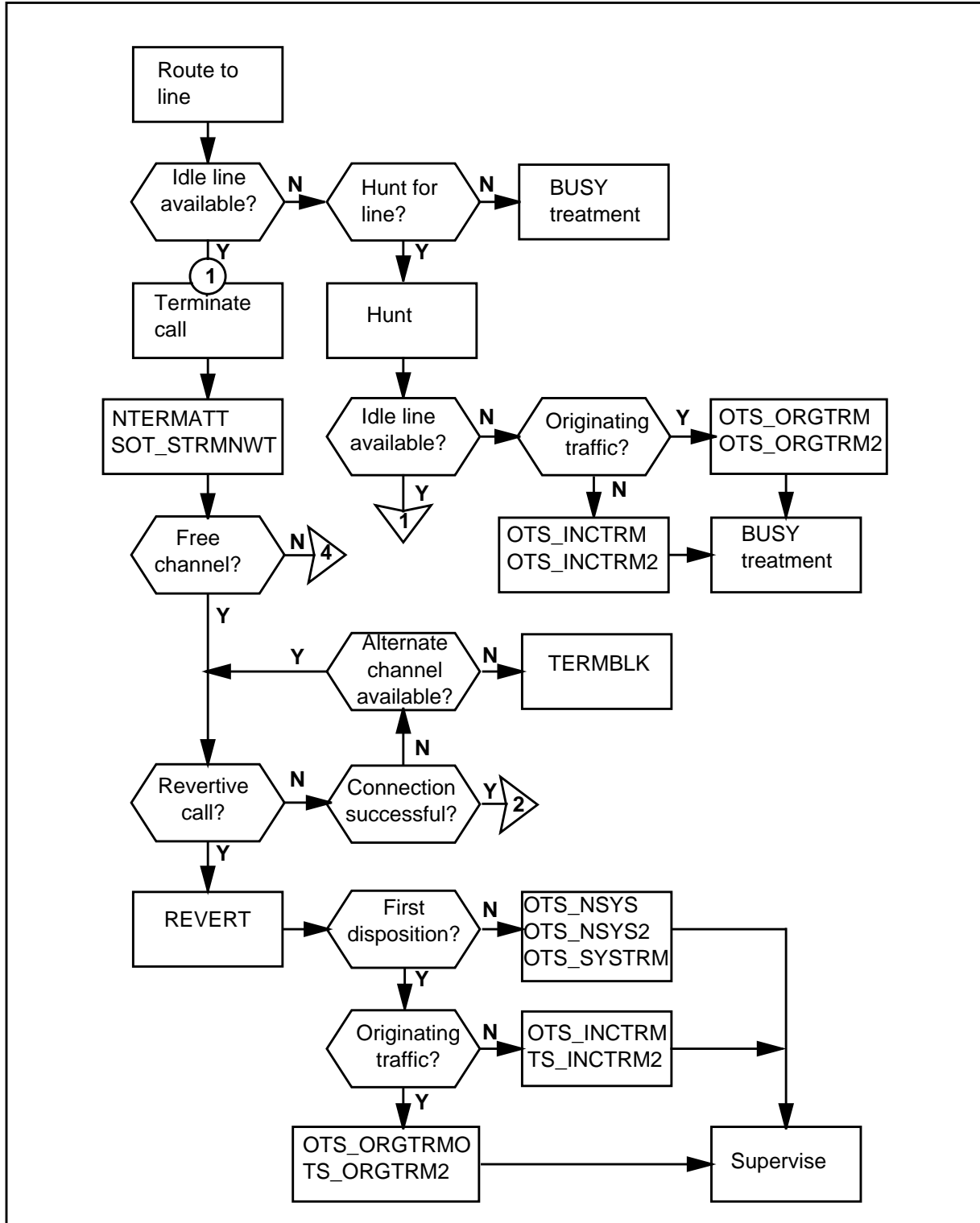
OM group LMD (continued)**OM group LMD registers (continued)**

OM group LMD (continued)

OM group LMD registers (continued)

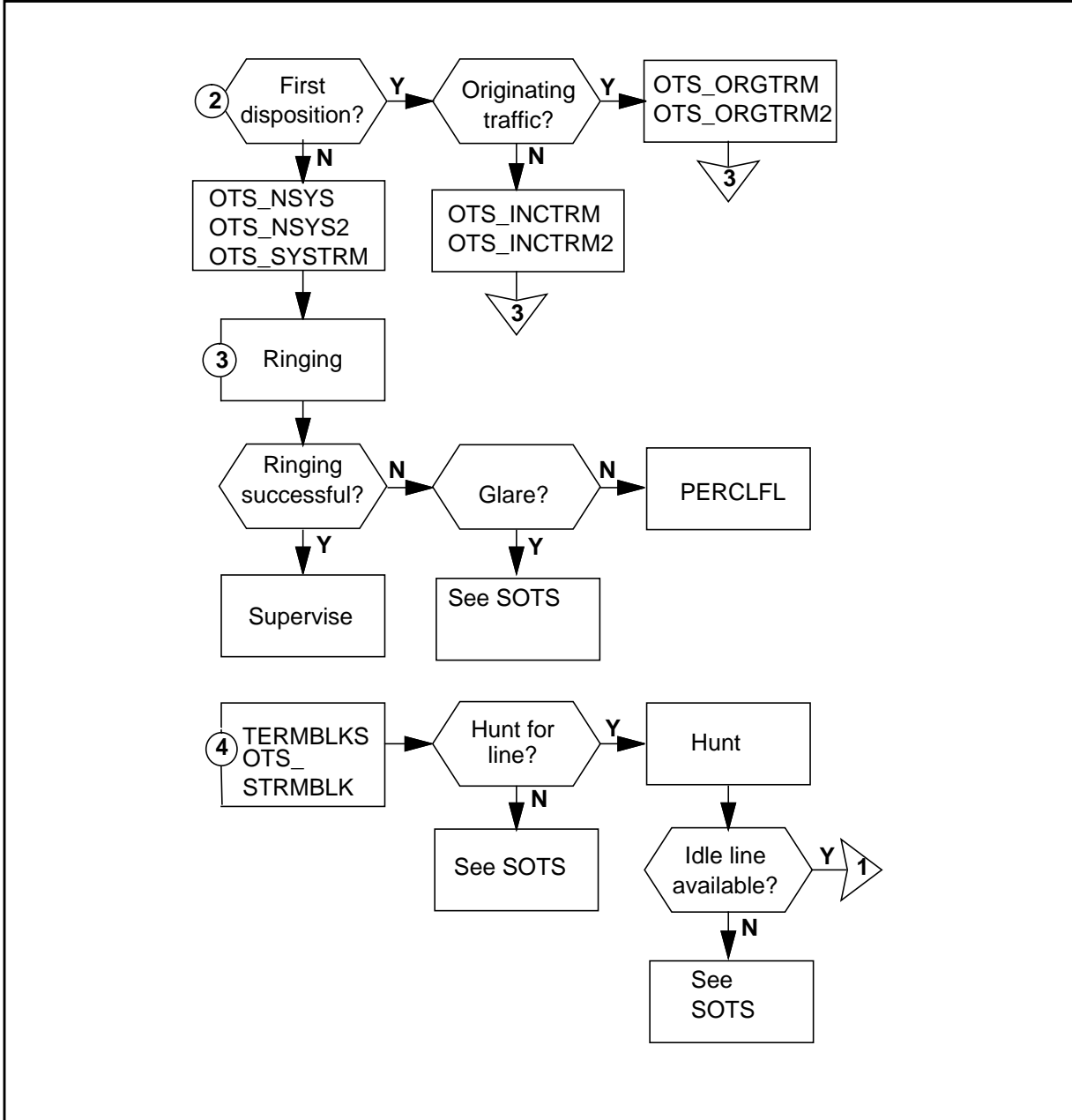

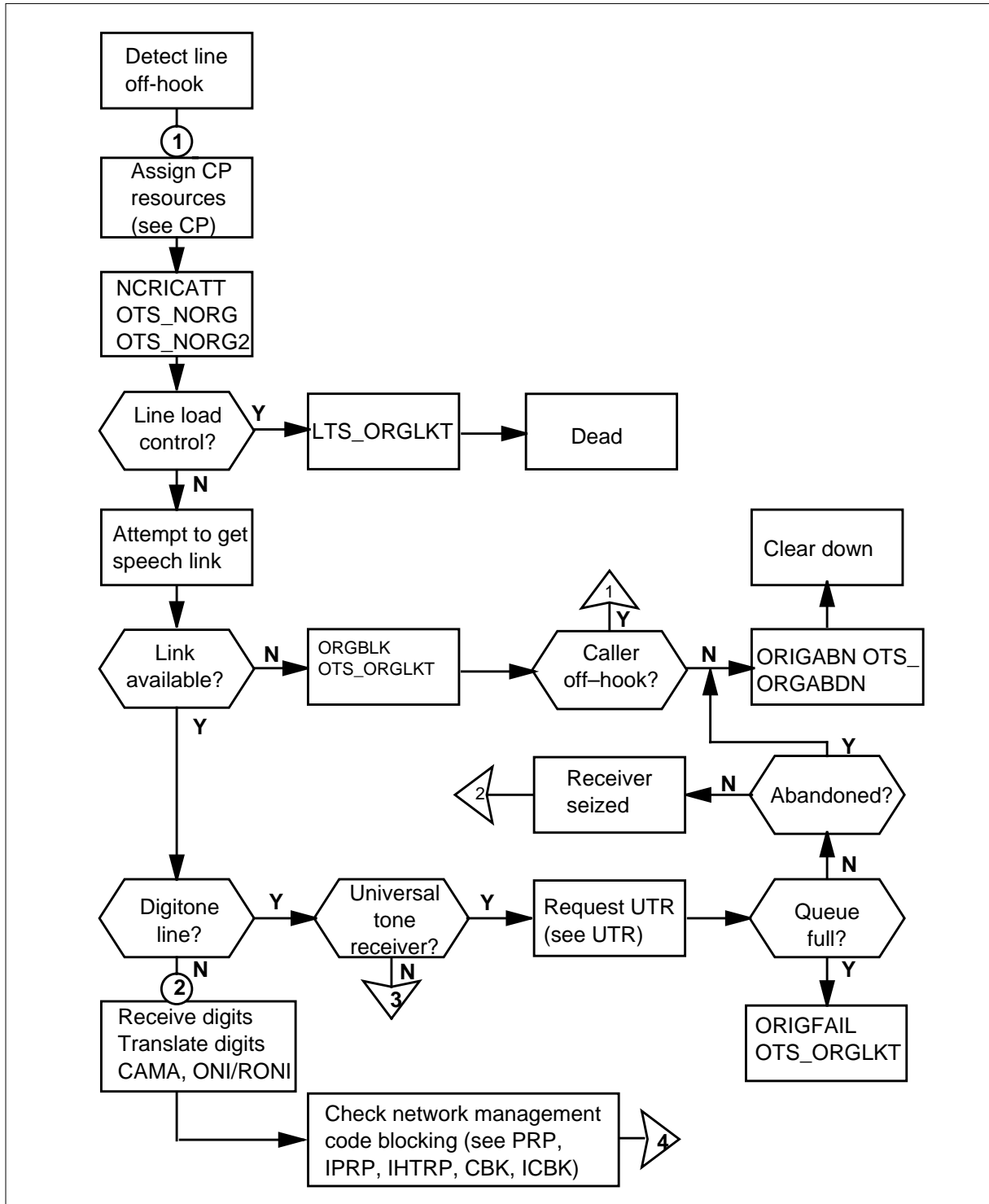
OM group LMD (continued)**OM group LMD registers (continued)**

OM group LMD (continued)

OM group LMD registers (continued)

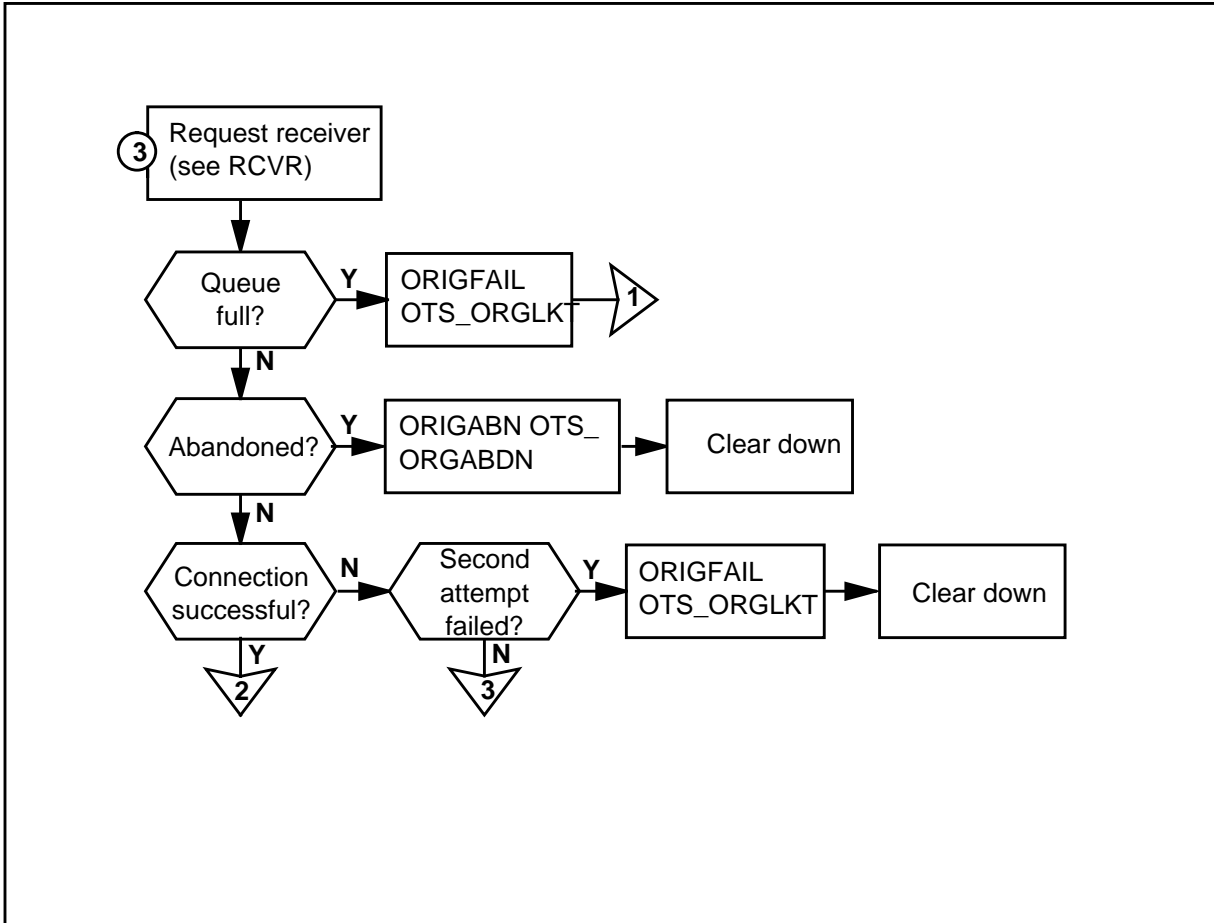

OM group LMD (continued)

OM group LMD registers (continued)

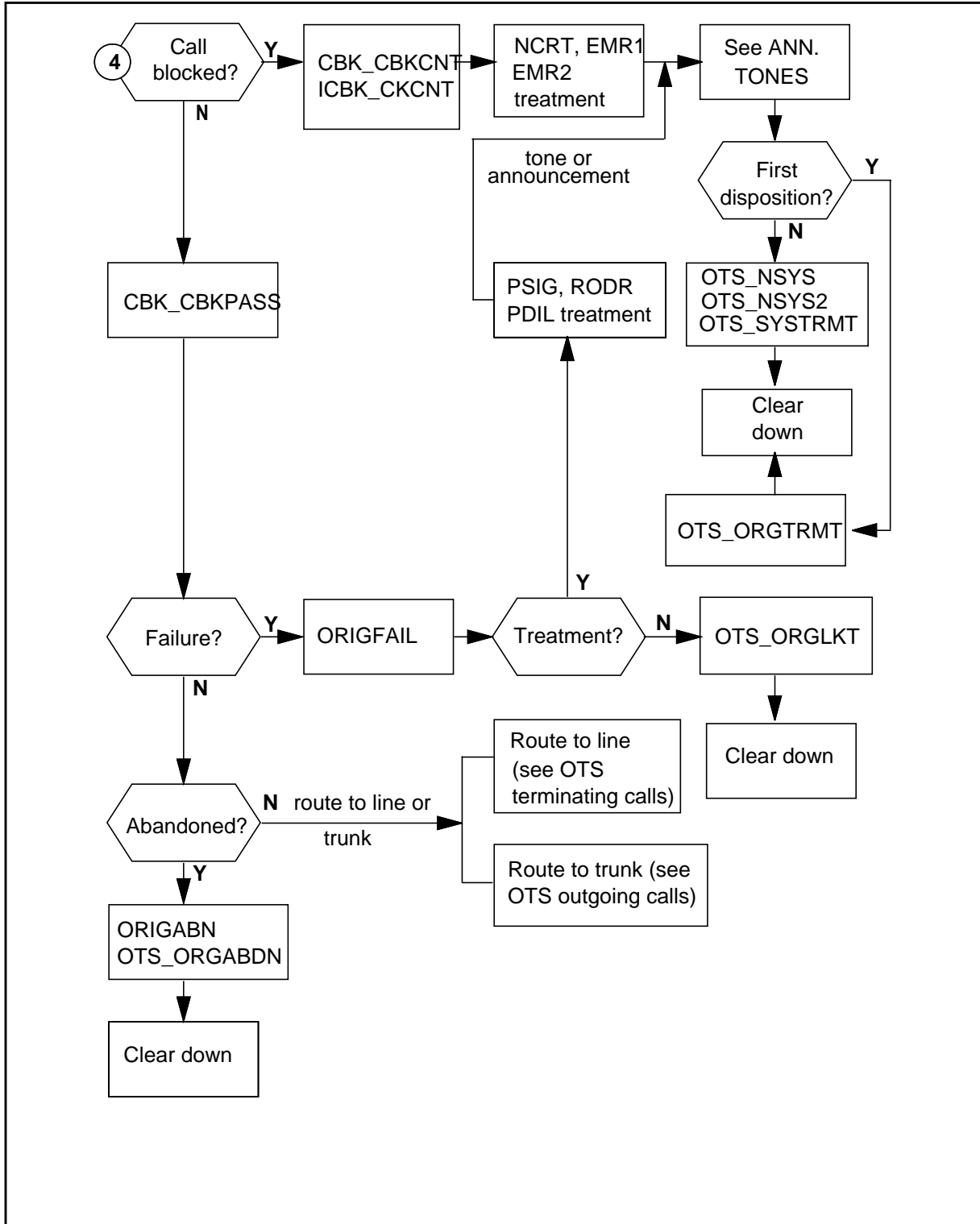

OM group LMD (continued)

OM group LMD registers (continued)

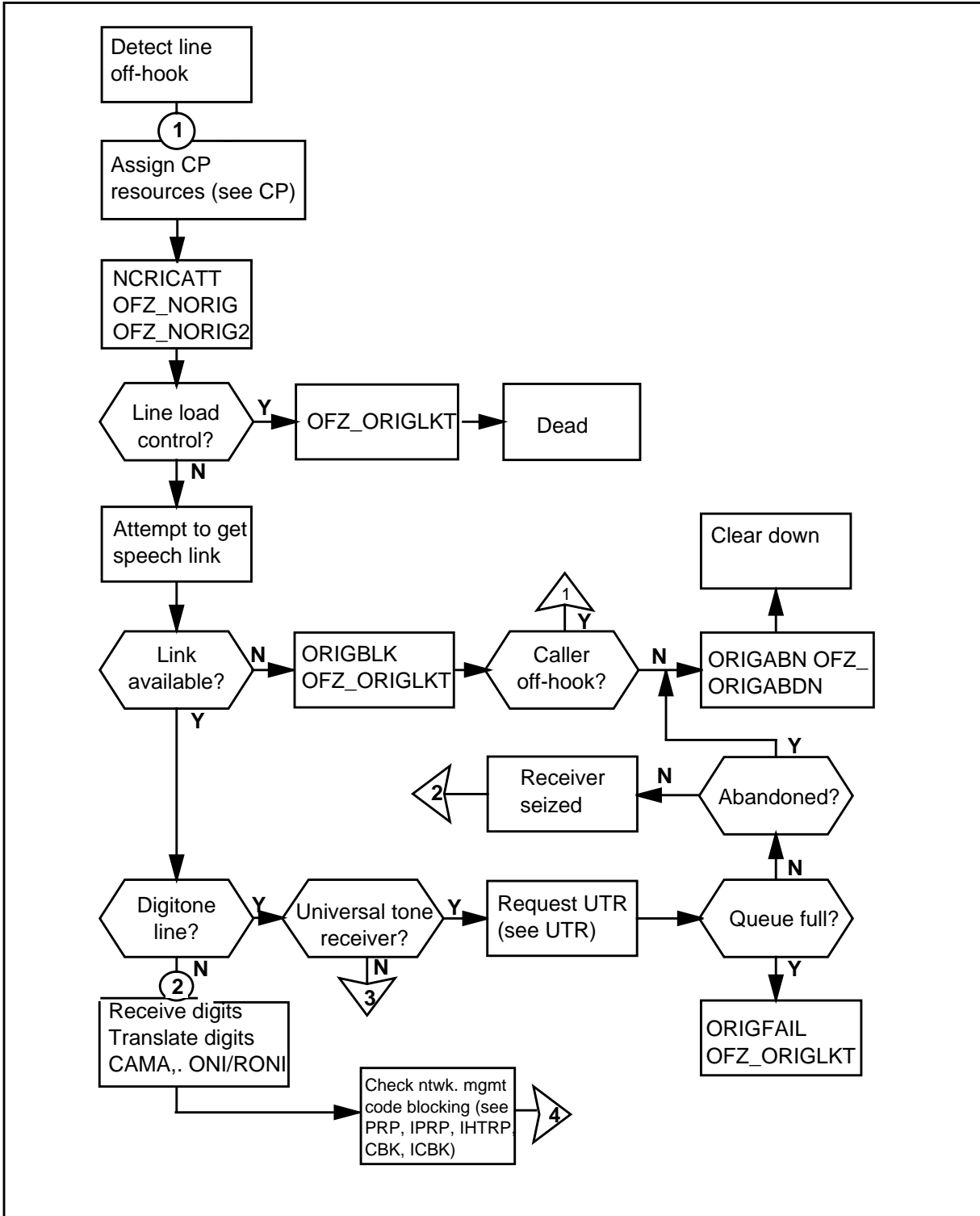

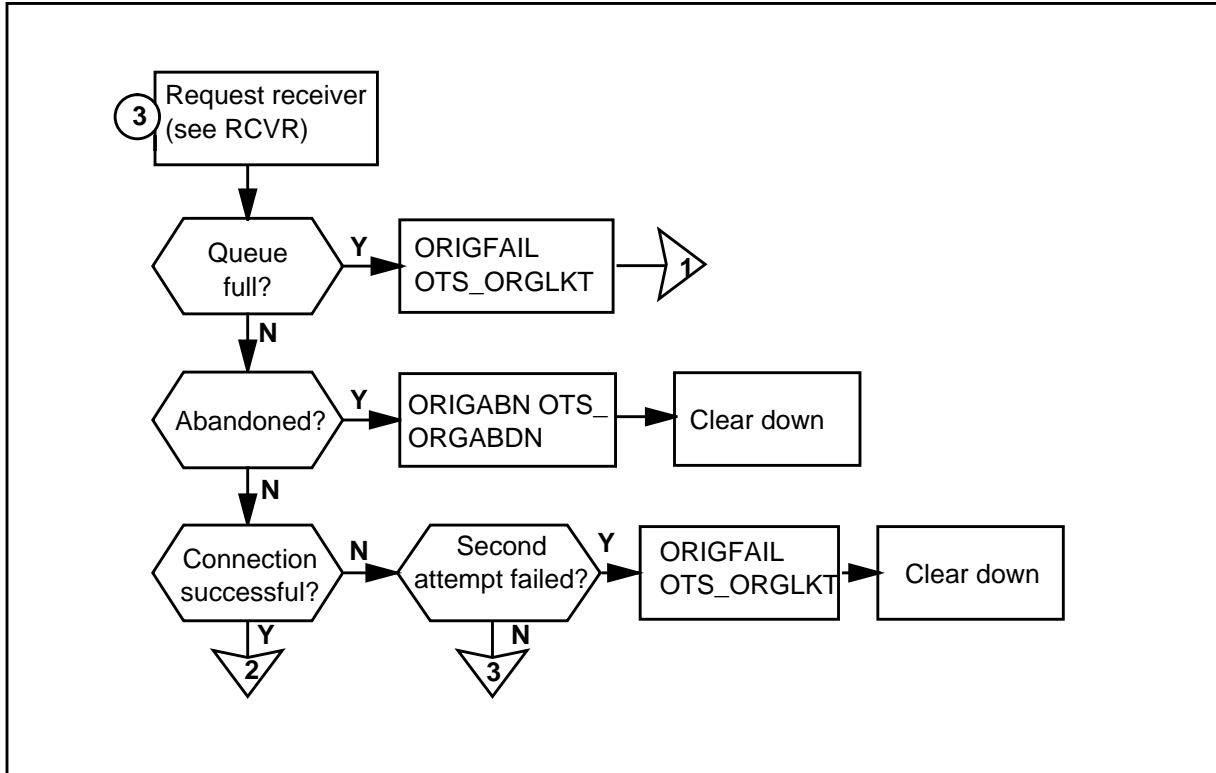
OM group LMD (continued)**OM group LMD registers (continued)**

OM group LMD (continued)

OM group LMD registers (continued)

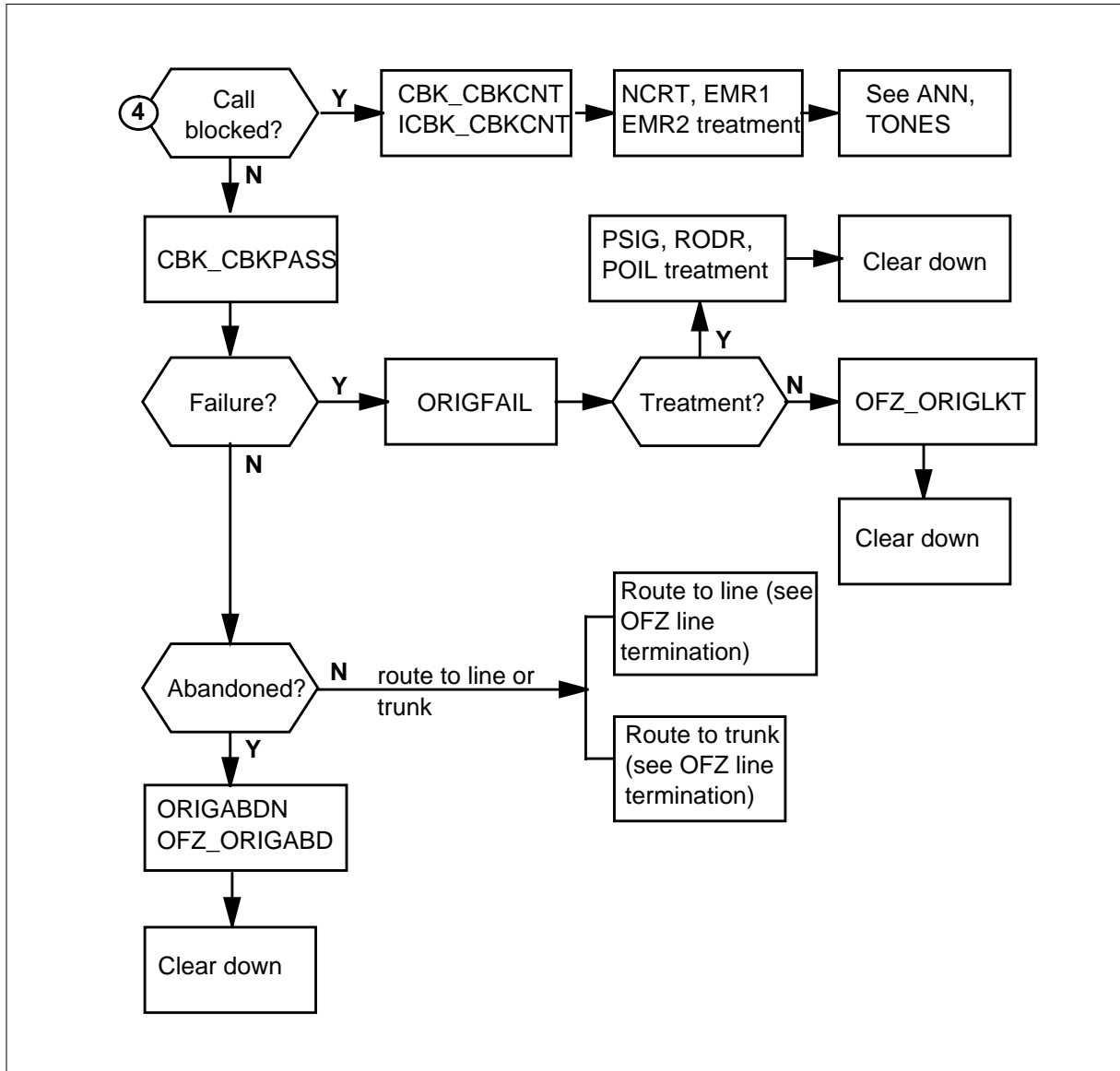

Register LMTRU

Traffic busy use (LMTRU)

Register LMTRU is a use register. The scan rate is 100 s. Register LMTRU records the number of lines that are call processing busy or call processing busy deloading.

OM group LMD (continued)

Register LMTRU release history

Register LMTRU introduced before BCS20.

BCS33

When you set the office parameter OMINERLANGS to Y, you change the use count from CCS to deci-erlangs before the count appears. Use the OMSHOW command on the ACTIVE class to display the usage count. The value in the active registers remains in CCS.

BCS31

Register LMTRU records traffic busy use on the SL-100 for IPE.

BCS20

Software change provides use register LMTRU in CCS or deci-erlangs

Associated registers

There are no associated registers

Associated logs

There are no associated logs.

Register MADNTATT

Multiple Appearance Directory Number (MADN) secondary member terminating attempts (MADNTATT)

Register MADNTATT counts secondary units of MADN groups in the PM that notify the system of an incoming call.

Register MADNTATT is increases for each electronic business set (EBS) or ringing 500/2500 set that the system notifies. The primary termination increases in NTERMATT.

Register MADNTATT does not count recalls or re-rings of a group unit.

This register does not increase in GL04.

Register MADNTATT release history

Register MADNTATT introduced before BCS20.

GL04

Register does not increase

BCS31

MADNTATT increases on the SL-100 for IPE

OM group LMD (continued)

BCS24

One tuple for each ELCM and LCMI that LMD provides

BCS23

One tuple for each VSR that LMD provides

BCS21

One tuple for each DLM that LMD provides

BCS20

One tuple for each ISLM that LMD provides

Associated registers

There are no associated registers.

Associated logs

There are no associated logs.

Register NORIGATT

Register NORIGATT counts originate call attempts that the LM reports to the central control. Register NORIGATT includes attempts to originate a three-way call.

This register increases at the start of call processing. The register increases before the system performs checks for line load control or congestion on the speech link to the network module. If congestion is present and the originator remains off-hook, the switch automatically makes several attempts at origination. Registers NORIGATT and LMD_ORIGBLK increase for each origination attempt.

Register NORIGATT release history

Register NORIGATT introduced before BCS20.

BCS31

Register NORIGATT increases on the SL-100 for IPE

BCS24

One tuple for each ELCM and LCMI that LMD provides

BCS23

One tuple for each VSR that LMD provides

BCS21

One tuple for each DLM that LMD provides

OM group LMD (continued)

BCS20

One tuple for each ISLM that LMD provides

Associated registers

Registers OFZ_NORIG counts start call attempts that the central control recognizes.

The relationship between LMD_NORIGATT and OFZ_NORIG is:

$$\Sigma \text{ LMD_ORIGATT} = (65536 * \text{OFZ_NORIG2}) + \text{OFZ_NORIG line modules}$$

Register OTS_NORG counts start call attempts that the central control recognizes.

The relationship between LMD_NORIGATT and OTS_NORG is:

$$\Sigma \text{ LMD_ORIGATT} = (65536 * \text{OTS_NORG2}) + \text{OTS_NORG line modules}$$

Register ORIGBLK counts originating call attempts that fail. The call attempts fail because an idle speech path from the originating LM to the network module is not present.

Associated logs

There are no associated logs.

Register NTERMATT

Terminating attempts (NTERMATT)

Register NTERMATT counts attempts to find an available speech link from the network module to a terminating line. This attempt occurs after call processing determines that the terminating line is available.

The count in NTERMATT includes call-waited calls that ring through when the earlier conversation ends. The count also includes calls that the secondary unit of a MADN group answer.

Register NTERMATT release history

Register NTERMATT introduced before BCS20.

BCS31

Register NTERMATT increases on the SL-100 for IPE

BCS24

One tuple for each ELCM and LCMI that LMD provides

OM group LMD (continued)

BCS23

One tuple for each VSR that LMD provides

BCS21

One tuple for each DLM that LMD provides

BCS20

One tuple for each ISLM that LMD provides

Associated registers

Register OFZ_TRMNWAT counts attempts to find a speech path to a terminating line.

The relationship between LMD_NTERMATT and OFZ_NTRMNWAT is:

$$\Sigma \text{ LMD_NTERMATT} = (65536 * \text{OFZ_TRMNWAT}^2) + \text{OFZ_TRMNWAT}$$

line modules

Register SOTS_STRMNWT counts attempts to find a speech path to a terminating line.

The relationship between LMD_NTERMATT and SOTS_STRMNWT is:

$$\Sigma \text{ LMD_NTERMATT} = (65536 * \text{SOTS_STRMNWT}^2) + \text{SOTS_STRMNWT}$$

line modules

Associated logs

There are no associated logs.

Register ORIGABN

Originating abandons before connection (ORIGABN)

Register ORIGABN counts originating call attempts that the subscriber abandons before call set up completes.

Large counts in ORIGABN indicate line problems or problems in PMs.

Register ORIGABN release history

Register ORIGABN was introduced before BCS20.

BCS31

Register ORIGABN increases on SL-100 for IPE

OM group LMD (continued)

BCS24

One tuple for each ELCM and LCMI that LMD provides

BCS23

One tuple for each VSR that LMD provides

BCS21

One tuple for each DLM that LMD provides

BCS20

One tuple for each ISLM that LMD provides

Associated registers

Register LMD_NORIGATT counts originating call attempts that the LM reports to the central control.

Register OFZ_ORIGABDN counts originating call attempts that the subscriber abandons before the system routes the call.

The relationship between LMD_ORIGABN and OFZ_ORIGABDN is:

$$\Sigma \text{ LMD_ORIGABN} = \text{OFZ_ORIGABDN line modules}$$

Register OTS_ORGABDN counts originating call attempts that the subscriber abandons before the call routes.

The relationship between LMD_ORIGABN and OTS_ORGABDN is:

$$\Sigma \text{ LMD_ORIGABN} = \text{OTS_ORGABDN line modules}$$

Associated logs

The system generates LINE106 when the system has problems during dial pulse reception on a line.

The system generates LINE108 when the system has problems during Digitone reception on a line.

Register ORIGBLK

Originating failures (ORIGBLK)

Register ORIGBLK counts originating call attempts that fail. The attempts fail because the idle speech path from the original LM to the network module is not present. The PM originates the call for as long as the caller stays off-hook.

OM group LMD (continued)

If the count in ORIGBLK is high, a fault condition can be present. Any RLM links that are manual busy or system busy are examples of a fault condition. Lower counts indicate a need to supply more links or reduce load.

Register ORIGBLK release history

Register ORIGBLK introduced before BCS20.

BCS31

Register ORIGBLK increases on the SL-100 for IPE

BCS24

One tuple for each ELCM and LCMI that LMD provides

BCS23

One tuple for each VSR that LMD provides

BCS21

One tuple for each DLM that LMD provides

BCS20

One tuple for each ISLM that LMD provides

Associated registers

Register LMD_NORIGATT counts originating attempts that the LM reports to the central control.

Register OFZ_ORIGLKT counts originating call attempts that fail and route to lock-out. These calls do not connect or route to treatment.

The relationship between LMD_ORIGBLK and OFZ_ORIGLKT is:

$\Sigma \text{ LMD_ORIGBLK} = \text{OFZ_ORIGLKT line modules}$

Register OTS_ORGLKT counts originating call attempts that fail and route to lockout. These calls do not connect or route to treatment.

The relationship between LMD_ORIGBLK and OTS_ORGLKT is:

$\Sigma \text{ LMD_ORIGBLK} = \text{OTS_ORGLKT line modules}$

Associated logs

The system generates NET130 when the system does not find a network path.

OM group LMD (continued)

Register ORIGFAIL

Originating attempt failures (ORIGFAIL)

Register ORIGFAIL counts originating call attempts that fail for one of the following reasons:

- the system does not sent enough digits before a timeout occurs (partial dial)
 - the system sends no digits before a timeout occurs (permanent signal)
 - additional pulses or bad tones are sent
 - the system generates two Digitone (DT) frequencies that have more than a 6 dB spread between both of the frequencies
 - the system receives a message type that was not planned from a PM during automatic number identification tests on record-able calls. A test failure is an example of a message type that was not planned.
-
- *Note:* Register does not increase in GL04 for the following reasons:
 - The system receives two Digitone (DT) frequencies that have more than a 6 dB spread between the frequencies.
 - The system receives a message type that is not planned from a PM during automatic number identification tests on recordable calls.

Register ORIGFAIL release history

ORIGFAIL introduced before BCS20.

GL04

Reasons noted above to not increase the register

BCS31

Register ORIGFAIL increases on the SL-100 for IPE

BCS24

One tuple for each ELCM and LCMI that LMD provides

BCS23

One tuple for each VSR that LMD provides

BCS21

One tuple for each DLM that LMD provides

OM group LMD (continued)

BCS20

One tuple for each ISLM that LMD provides

Associated registers

Register TRMTCM_TCMPSIG counts calls that the system routes to permanent signal timeout treatment. The system routes the call to treatment because the system does not receive digits before a timeout.

Register TRMTCM_TCMPDIL counts calls that the system routes to partial dial timeout treatment. The system routes the call to treatment because the system received a minimum of one digit, but not all of those required to complete the call.

Register TRMTER_TERRODR counts calls that the system routes to reorder treatment because the system receives distorted signals during dialing or impulsing.

Associated logs

The system generates AMAB151 when an identification failure occurs while the system makes a Station-Message Detail Recording (SMDR) record for a call.

The system generates LINE108 when the system has problems during DT reception on a line. If the problem interrupts a call in progress, the DMS switch routes the call to treatment and generates LINE138. Log LINE138 identifies the treatment for the line.

The system generates LINE109 when the system has problems during call processing. If the problem interrupts a call in progress, the DMS switch routes the call to treatment and generates LINE138. Log LINE138 identifies the treatment for the line.

The system generates LINE138 when a call routes to treatment after the call call processes busy.

The system generates LINE104 when the system has problems during call processing. If the problem interrupts a call in progress, the DMS switch routes the call to treatment and generates LINE138. Log LINE138 identifies the treatment for the line.

The system generates LINE105 when the system has problems during call processing. If the problem interrupts a call in progress, the DMS switch routes the call to treatment and generates LINE138. Log LINE138 identifies the treatment for the line.

OM group LMD (continued)

The system generates LINE106 when the system has problems during DP reception on a line. If the problem interrupts a call in progress, the DMS switch routes the call to treatment and generates LINE138. Log LINE138 identifies the treatment for the line.

Register PERCLFL

Terminating call attempt failures (PERCLFL)

Register PERCLFL counts calls that cannot terminate on a line because of problems in ringing the terminating line.

A ringing failure on an emergency service line does not cause the call to fail and does not increase PERCLFL. The system attempts ringing until the system is successful.

When you set the office parameter PER_CALL_GND_LOOP_TEST in table OFCVAR to Y, PERCLFL includes loop faults. The system detects loop faults in attempted terminations on ground start lines.

Register PERCLFL release history

Register PERCLFL introduced before BCS20.

BCS31

Register PERCLFL increases on the SL-100 for IPE

BCS24

One tuple for each ELCM and LCMI that LMD provides

BCS23

One tuple for each VSR that LMD provides

BCS21

One tuple for each DLM that LMD provides.

BCS20

One tuple for each ISLM that LMD provides.

Associated registers

Register TRMTER_TERSYFL counts calls that the system routes to system failure treatment. The system routes these calls to treatment because of a software or hardware failure in the switching unit.

Associated logs

The system generates LINE107 when the system requests a line insulation test.

OM group LMD (continued)

The system generates LINE110 when the system detects an electromagnetic force on a line that is not normal. The system detects this force during a foreign potential test.

The system generates LINE113 if the system has problems when ringing applies to a line. If the problem interrupts a call in progress, the DMS switch routes the call to treatment and generates LINE138. Log LINE138 identifies the treatment for the line.

Register REVERT

Revertive call attempts (REVERT)

Register REVERT counts revertive calls initiated on an LM. This register increases when ringing starts after the caller goes on-hook for the first time.

This register does not increase in GL04.

Register REVERT release history

Register REVERT introduced before BCS20.

GL04

Register does not increase

BCS31

Register REVERT increases on the SL-100 for IPE

BCS24

One tuple for each ELCM and LCMI that LMD provides

BCS23

One tuple for each VSR that LMD provides

BCS21

One tuple for each DLM that LMD provides

BCS20

One tuple for each ISLM that LMD provides

Associated registers

There are no associated registers.

Associated logs

The system generates LINE138 when the system routes a call to treatment after the call is call processing busy.

OM group LMD (continued)

Register STKCOINS

Stuck coins (STKCOINS)

Register STKCOINS counts attempts to collect or return coins that fail because the coins are stuck.

STKCOINS increases when call processing stops an attempt to collect or return the coins. The call proceeds as if the attempt to collect or return the coin completed.

This register does not increase in GL04.

Register STKCOINS release history

Register STKCOINS introduced before BCS20.

GL04

Register does not increase

BCS31

Register STKCOINS increases on the SL-100 for IPE

BCS24

One tuple for each ELCM and LCMI that LMD provides

BCS23

One tuple for each VSR that LMD provides

BCS21

One tuple for each DLM that LMD provides

BCS20

One tuple for each ISLM that LMD provides

Associated registers

There are no associated registers.

Associated logs

The system generates LINE112 when the system fails to remove a stuck coin on a line connected to a coin box.

Register TERMBLK

Terminating failures (TERMBLK)

OM group LMD (continued)

Register TERMBLK counts attempts to find a speech link from the network module to a terminating line that fail. The attempts fail for one of the following reasons:

- there are no speech links available from the network to a terminating line
- no match between an idle channel on the links to the network and an idle channel on the link shelf that serves the terminating line is present

Register TERMBLK release history

Register TERMBLK introduced before BCS20.

BCS31

Register TERMBLK increases on the SL-100 for IPE

BCS24

One tuple for each ELCM and LCMI that LMD provides

BCS23

One tuple for each VSR that LMD provides

BCS21

One tuple for each DLM that LMD provides

BCS20

One tuple for each ISLM that LMD provides

Associated registers

Register OFZ_TRMBLK counts attempts to find a voice path from the network module to a terminating line that fail. The attempts fail for one of the following reasons:

- all LM channels to the network are busy
- no match between an idle channel on the links to the network and an idle channel on the line shelf that serves the terminating line is present

The relationship between LMD_TERMBLK and OFZ_TRMBLK is:

Σ LMD_TERMBLK = OFZ_TRMBLK line modules

SOTS_STRMBLK counts attempts to find a voice path from the network to a terminating line that fail. These attempts fail for one of the following reasons:

- all LM channels to the network are busy
- no match is present between an idle channel on the links to the network and an idle channel on the line shelf that serves the terminating line

OM group LMD (end)

The relationship between LMD_TERMBLK and SOTS_STRMBLK is:

Σ LMD_TERMBLK = SOTS_STRMBLK line modules

Register SOTS_STRMRBLK counts calls that the system routes to network blockage normal (NBLN) traffic treatment. The system routes these calls to treatment because the calls fail to find a voice path from a network module to a terminating line.

Register SOTS_STRMMFL counts calls that fail to find a voice path to a terminating line. The attempts fail because a network connection is not available.

Register TRMTRS_TRSNBLN counts calls that route to NBLN traffic treatment when the call aborts. The system routes these calls to treatment because of a failure to get a channel in the terminating PM.

Register TRMTRS_TRSNBLH counts calls that route to the network blockage heavy (NBLH) traffic treatment when the call aborts. The system routes the call to treatment because of failure to get a path through the network.

Associated logs

The system generates NET130 when a network path is not present.

OM group LMSCPUST

OM description

Local message switch central processing unit status. (LMSCPUST)

The OM group LMSCPUST displays the central processing unit (CPU) occupancy data of a local message switch (LMS) unit.

The LMSCPUST contains seven registers that perform the following procedures:

- accumulate call processing class occupancy
- accumulate scheduler class CPU occupancy
- accumulate foreground class CPU occupancy
- accumulate maintenance class CPU occupancy
- accumulate CPU occupancy of the processes that run in the idle schedule class
- accumulate input and output interrupt CPU occupancy
- accumulate background class CPU occupancy

Release history

The OM group LMSCPUST introduced in CSP04.

Registers

The OM group LMSCPUST registers appear on the MAP terminal as follows:

LMSCP	LMSSCHED	LMSSYS	LMSMAINT	LMSEBKG
LMSIDLE	LMSIO			

Group structure

The OM group LMSCPUST provides two tuples for each LIM unit in table LIMINV.

Key field:

There is no key field.

Info field:

Duplex_ncmnode_info

STRUCT

OM group LMSCPUST (continued)

namePM_TYPE,%LIM

idunsignedint,%LIM number

unitunsignedint,%LIM unit number

ENDSTRUCT;

Associated OM groups

There are no associated OM groups.

Associated functional groups

The local message switch (LMS) associates with OM group LMSCPUST.

OM group LMSCPUST (continued)

OM group LMSCPUST registers

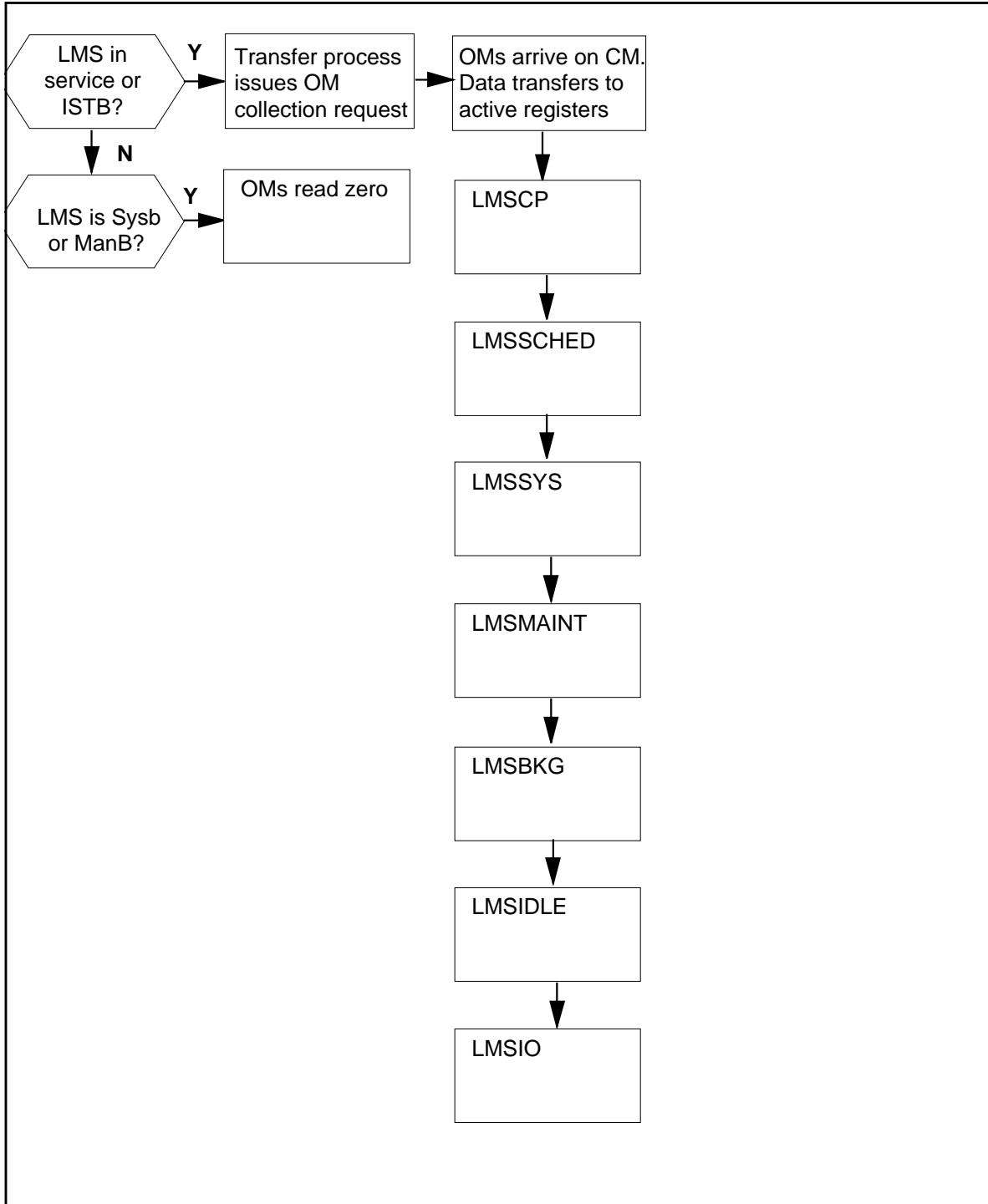

OM group LMSCPUST (continued)

Register LMSCP

Local message switch call processing class occupancy. (LMSCP)

Register LMSCP reports the percentage that CPU uses to maintain call processing. In the LMS, the messaging system is the main user of the call processing CPU class. The call processing CPU class provides real-time performance. The messaging system uses the call processing class time to maintain message routes and to program mapper card. The messaging system allows payload traffic to switch through the LPP. The system can use the LMS switch hardware to switch payload traffic through the LPP.

Register LMSCP release history

Register LMSCP introduced in CSP04.

Associated registers

There are no associated registers.

Associated logs

There are no associated logs.

Extension registers

There are no extension registers.

Register LMSSCHED

Local message switch scheduler class occupancy. (LMSSCHED)

Register LMSSCHED accumulates the scheduler class central processing unit occupancy.

Register LMSSCHED release history

Register LMSSCHED introduced in CSP04.

Associated registers

There are no associated registers.

Associated logs

There are no associated logs.

Extension registers

There are no extension registers.

Register LMSSYS

Local message switch system class occupancy. (LMSSYS)

OM group LMSCPUST (continued)

Register LMSSYS accumulates foreground class CPU occupancy.

Register LMSSYS release history

Register LMSSYS introduced in CSP04.

Associated registers

There are no associated registers.

Associated logs

There are no associated logs.

Extension registers

There are no extension registers.

Register LMSMAINT

Local message switch maintenance class occupancy. (LMSMAINT)

Register LMSMAINT accumulates maintenance class CPU occupancy.

Register LMSMAINT release history

Register LMSMAINT introduced in CSP04.

Associated registers

There are no associated registers.

Associated logs

There are no associated logs.

Extension registers

There are no extension registers.

Register LMSBKG

Local message switch background class occupancy. (LMSBKG)

Register LMSBKG accumulates background class CPU occupancy.

Register LMSBKG release history

Register LMSBKG introduced in CSP04.

Associated registers

There are no associated registers.

OM group LMSCPUST (end)

Associated logs

There are no associated registers.

Extension registers

There are no extension registers.

Register LMSIDLE

Local message switch idle class occupancy. (LMSIDLE)

Register LMSIDLE accumulates CPU occupancy of the processes that run in the idle schedule class.

Register LMSIDLE release history

Register LMSIDLE introduced in CSP04.

Associated registers

There are no associated registers.

Associated logs

There are no associated logs.

Extension registers

There are no extension registers.

Register LMSIO

Local message switch input and output interrupt occupancy. (LMSIO)

Register LMSIO accumulates input and output interrupt CPU occupancy.

Register LMSIO release history

Register LMSIO introduced in CSP04.

Associated registers

There are no associated registers.

Associated logs

There are no associated logs.

Extension registers

There are no extension registers.

OM group LMSMEM

OM description

Local message switch memory

LMSMEM displays the memory usage over the OM transfer period.

LMSMEM contains six registers that:

- display the number of available program store (PS) vast areas. A vast area is 32K-1 words in size.
- displays the number of available data store (DS) vast areas.
- displays the amount of total DS memory.
- displays the amount of available DS memory.
- displays the amount of total PS memory.
- displays the amount of available PS memory.

Release history

OM group LMSMEM was introduced in CSP04.

Registers

The following OM group LMSMEM registers display on the MAP terminal as follows:

```
PSVTABL   DSVTABL   LMSDSTOT   LMSDSAVAL   LMSPSTOT  
LMSPSAVAL
```

Group structure

OM group LMSMEM provides two tuples for each LIM unit in table LIMINV.

Key field:

None

Info field:

Duplex_ncmnode_info

STRUCT

```
    name    pm_type,    %LIM  
    id      unsignedint, %LIM number  
    unit    unsignedint, %LIM unit number
```

ENDSTRUCT;

OM group LMSMEM (continued)

Associated OM groups

None

Associated functional groups

Local message switch

OM group LMSMEM (continued)

OM group LMSMEM registers

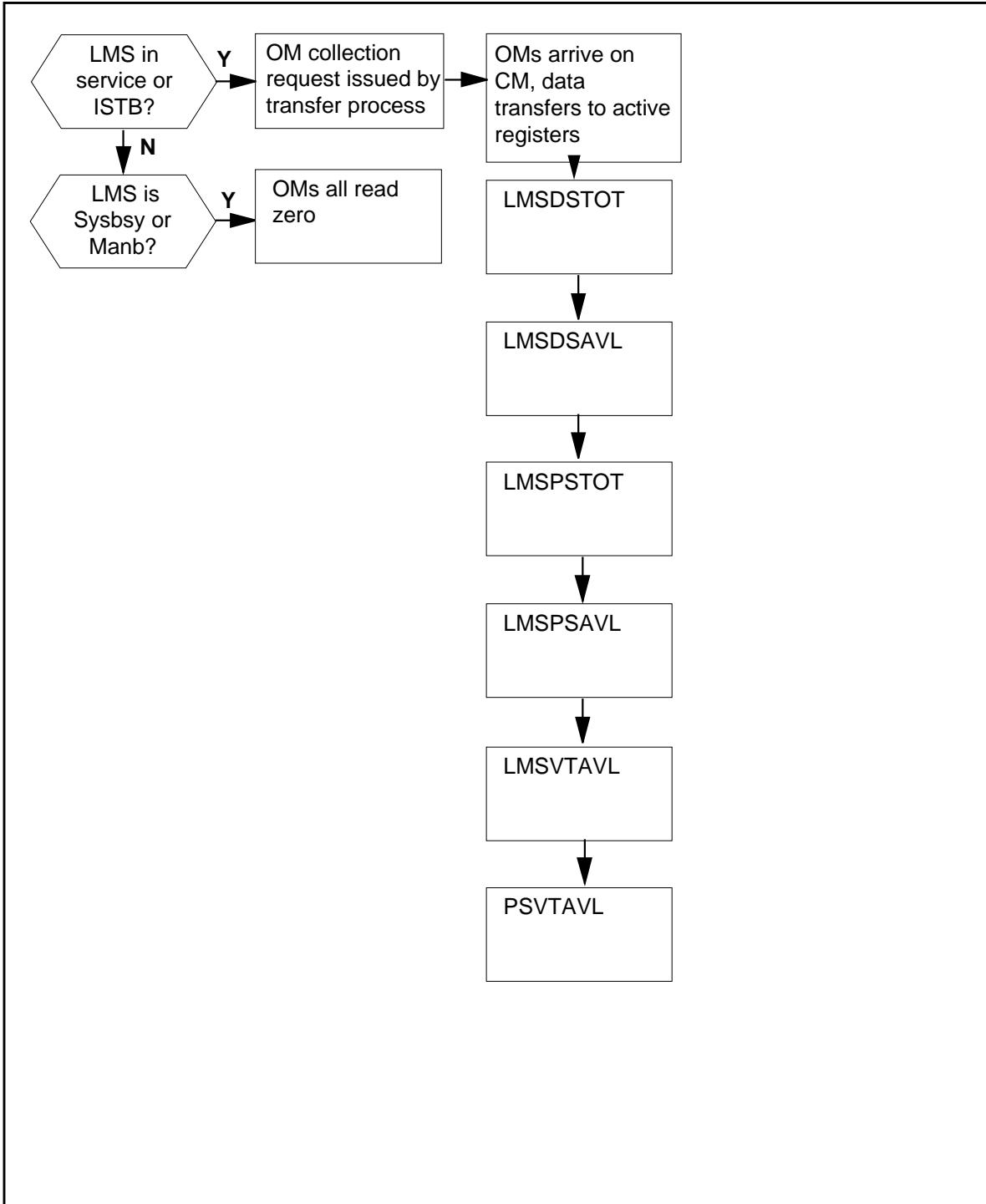

OM group LMSMEM (continued)

Register PSVTAVL

Program store vast areas available

PSVTAVL displays the number of available program store (PS) vast areas.

Register PSVTAVL release history

Register PSVTAVL was introduced in CSP04.

Associated registers

None

Associated logs

None

Extension registers

None

Register DSVTAVL

Data store vast areas available

DSVTAVL displays the number of available data store (DS) vast areas.

Register DSVTAVL release history

Register DSVTAVL was introduced in CSP04.

Associated registers

None

Associated logs

None

Extension registers

None

Register LMSDSTOT

Local message switch data store total

LMSDSTOT displays the amount of total DS memory.

Register LMSDSTOT release history

Register LMSDSTOT was introduced in CSP04.

OM group LMSMEM (continued)

Associated registers

None

Associated logs

None

Extension registers

None

Register LMSDSAVL

Local message switch program store available

LMSDSAVL displays the amount of available DS memory.

Register LMSDSAVL release history

Register LMSDSAVL was introduced in CSP04.

Associated registers

None

Associated logs

None

Extension registers

None

Register LMSPSTOT

Local message switch program store total

LMSPSTOT displays the amount of total PS memory.

Register LMSPSTOT release history

Register LMSPSTOT was introduced in CSP04.

Associated registers

None

Associated logs

None

Extension registers

None

OM group LMSMEM (end)

Register LMSPSAVL

Local message switch program store available

LMSPSAVL displays the amount of available PS memory.

Register LMSPSAVL release history

Register LMSPSAVL was introduced in CSP04.

Associated registers

None

Associated logs

None

Extension registers

None

OM group LOGS

OM description

Log messages (LOGS)

The OM group LOGS counts:

- lost log reports
- software error reports from the central control complex (CCC)
- software error reports from peripheral modules (PM)
- trap reports from PMs

Release history

The OM group LOGS introduced in BCS2.

BCS22

PMSWERCT and PMTRAPCT added to BCS22.

BCS21

SWERRCT added to BCS21.

Registers

The OM group LOGS registers display on the MAP terminal as follows:

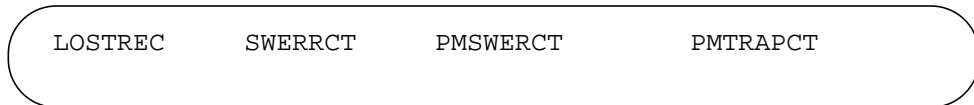

Group structure

The OM group LOGS

Key field:

There is no key field

Info field:

There is no info field

Office parameter LOG_CENTRAL_BUFFER_SIZE in table OFCVAR defines the length of the central log buffer.

Associated OM groups

The OM group SYSPERF provides information on the performance of the switch.

OM group LOGS (continued)

The OM group CP2 provides information on the use of extended call control blocks.

Associated functional groups

The following are associated functional groups for the OM group LOGS:

- DMS-100 Local
- DMS-100/200 Local/Toll
- DMS-100/200 TOPS
- DMS-200 Toll
- DMS-200 TOPS
- DMS-100 Meridian
- DMS-MTX
- DMS-250 Toll/Tandem
- DMS-300
- Meridian SL-100 PBX

Associated functionality codes

The associated functionality codes for the OM group LOGS appear in the following table.

Functionality	Code
Common Basic	NTX001AA
Switch Performance Monitoring System	NTX738AA

OM group LOGS (continued)

The OM group LOGS

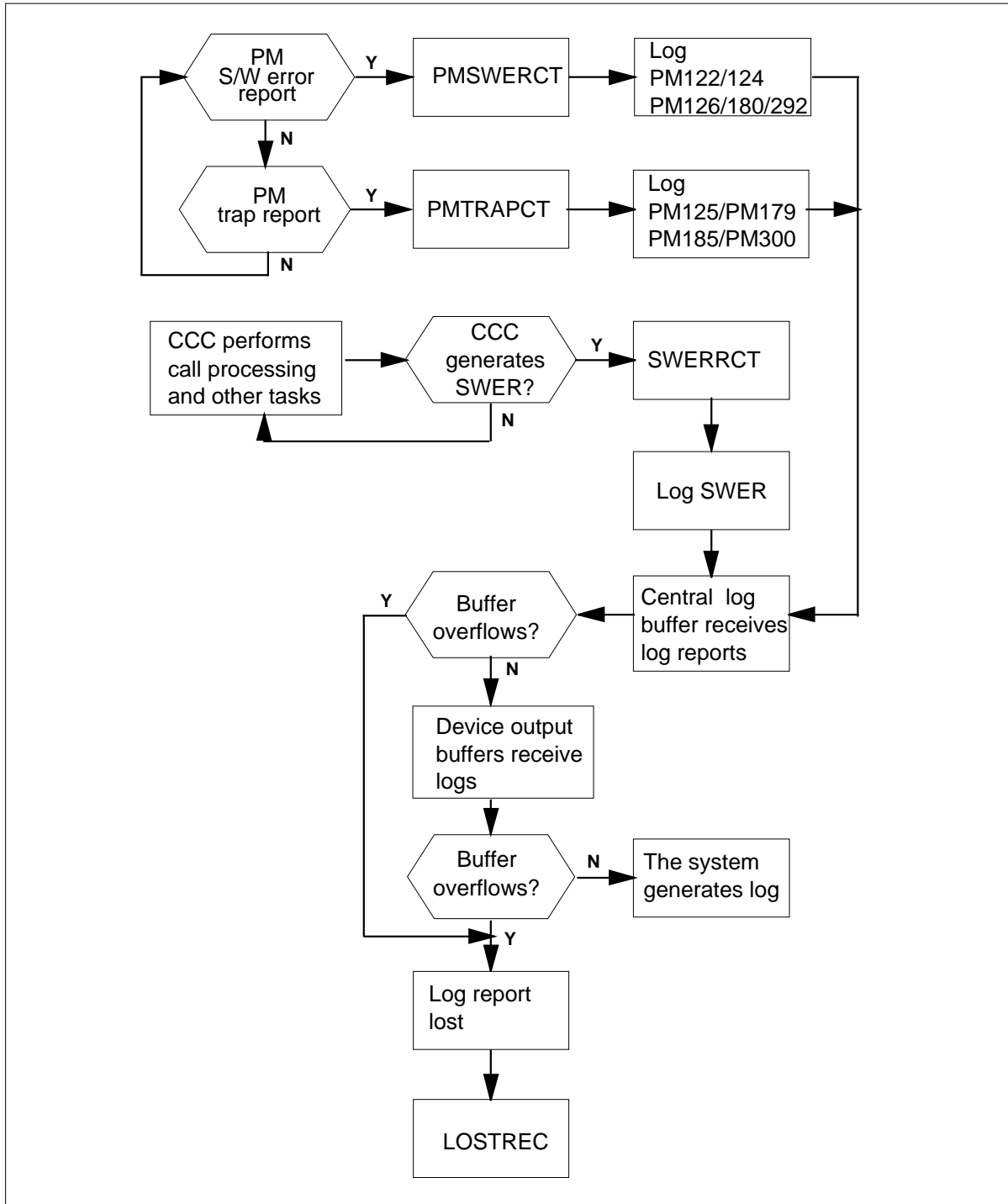

OM group LOGS (continued)

Register LOSTREC

Register lost records (LOSTREC)

Register LOSTREC counts log reports lost because the central log buffer or the output device buffers overflows.

Register LOSTREC release history

Register LOSTREC introduced before BCS20.

Associated registers

There are no associated registers.

Associated logs

There are no associated logs.

Register PMSWERCT

Peripheral module software error (PMSWERCT)

Register PMSWERCT counts software error reports that peripheral modules (PM) generate and hardware errors that affect software execution.

The value in PMSWERCT can be larger than the number of log reports because of log suppression or buffer overflows.

Register PMSWERCT release history

Register PMSWERCT introduced in BCS22.

Associated registers

Register PM_PMERR counts errors detected in an in-service PM. Register PM_PMERR counts errors even if the errors result in additional maintenance action.

Associated logs

The system generates PM122 after an exception report is received from a PM.

The system generates PM124 and PM126 when the peripheral processor of a PM detects a condition that is not normal. This condition is not hardware related or is not yet linked to a hardware fault.

The system generates PM180 because software executed improperly or because a hardware problem affects software execution.

The system generates PM290 for DSPM and ICRM SWERRs.

OM group LOGS (continued)

Register PMTRAPCT

Peripheral module trap (PMTRAPCT)

Register PMTRAPCT counts trap reports that peripheral modules (PM) generate.

The value in PMTRAPCT can be larger than the number of log reports because of log suppression or buffer overflows.

Collect and bring trap log reports and all associated logs to the attention of the technical support group.

Register PMSWERCT release history

Register PMTRAPCT introduced in BCS22.

Associated registers

Register PM_PMERR counts errors that an in-service PM detects. Register PM_PMERR counts errors even if the errors result in additional maintenance action.

Associated logs

The system generates PM125 when a firmware or hardware error is detected in the peripheral processor of the PM.

The system generates PM179 when a software condition occurs that affects the normal operation of a PM.

The system generates PM180 and PM300 when an error condition causes a trap interrupt that the firmware, hardware or software detects.

Register SWERRCT

Software error count (SWERRCT)

Register SWERRCT counts software error reports that the central control complex (CCC) generates.

Software error reports are output as SWER log reports. The value in SWERRCT can be larger than the number of SWER log reports because of log suppression or buffer overflows.

OM group LOGS (end)

The following cause software error reports:

- software errors
- data corruption
- data errors made by the user

Collect and bring SWER log reports and all associated logs to the attention of the technical support group.

Register SWERRCT release history

Register SWERRCT introduced in BCS21.

Associated registers

There are no associated registers.

Associated logs

The system generates SWER if a software problem occurs. The system also generates SWER if the LOGUTIL MAP level makes a manual request for a log trace.

OM group M20CARR1

OM description

M20 carrier 1 (M20CARR1)

The OM group M20CARR1 provides information about alarms and state changes that occur on M20 carriers. These 30-channel carriers with 32 time slots support communication at a rate of 2048 kbits/s between the DMS system and the Japanese network.

Release history

The OM group M20CARR1 introduced in BCS29.

Registers

The OM group M20CARR1 registers display on the MAP terminal as follows:

FAERR	ALERR	AISSERR	SLIPPERR
FAFLT	ALFLT	AISSFLT	SLIPPFLT
CARSYSB	CARCBSY	CARMANB	

Group structure

The OM group M20CARR1 provides one tuple for each office.

Key field:

There is no Key field

Info field:

M20OMINF

Associated OM groups

The OM group M20CARR2

Associated functional groups

There are no associated functional groups.

Associated functionality codes

The associated functionality codes for OM group M20CARR1 appear in the following table.

Functionality	Code
NTXH11AA	M20 Maintenance

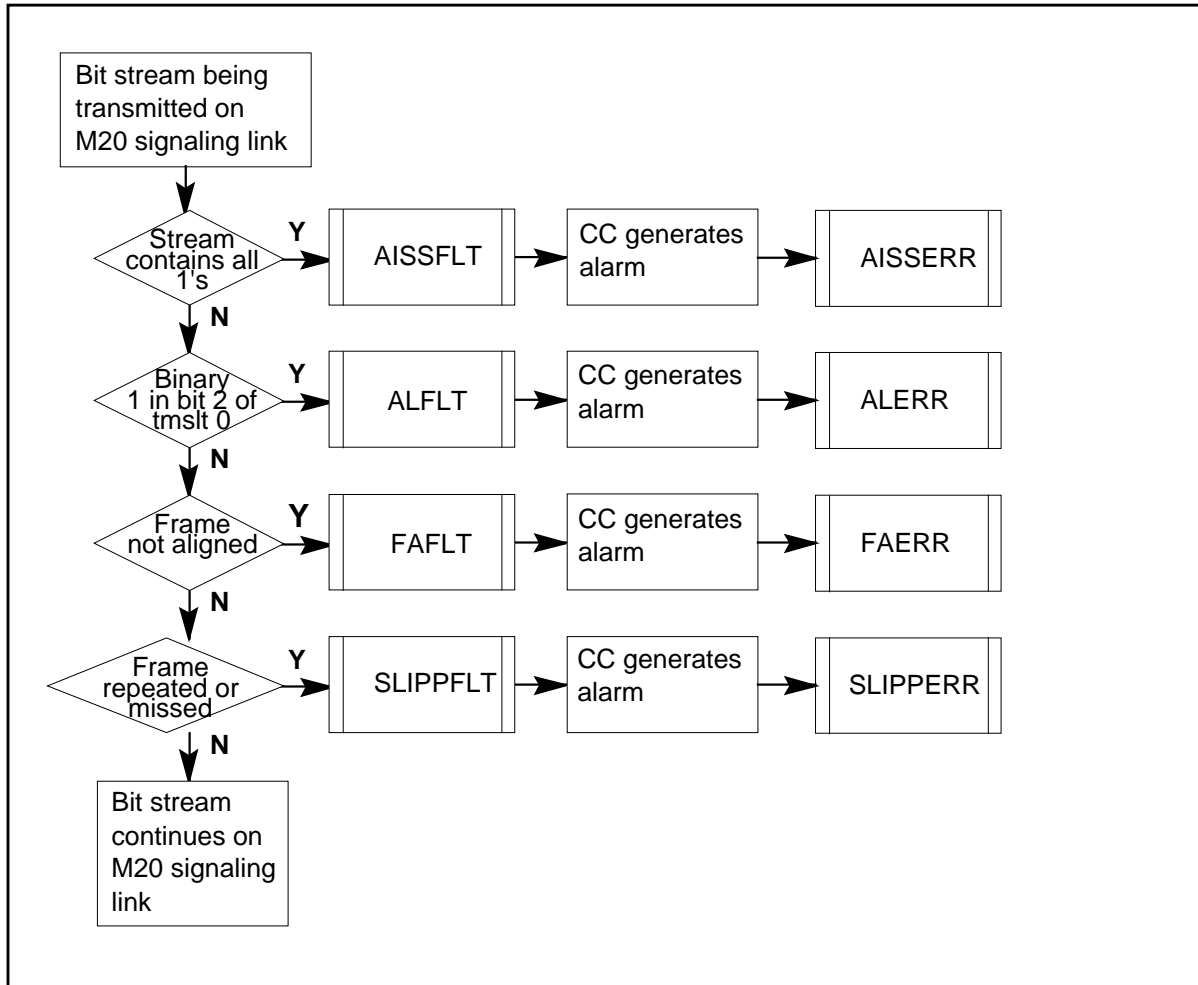
OM group M20CARR1 (continued)**OM group M20CARR1 registers**

OM group M20CARR1 (continued)

OM group M20CARR1 usage registers

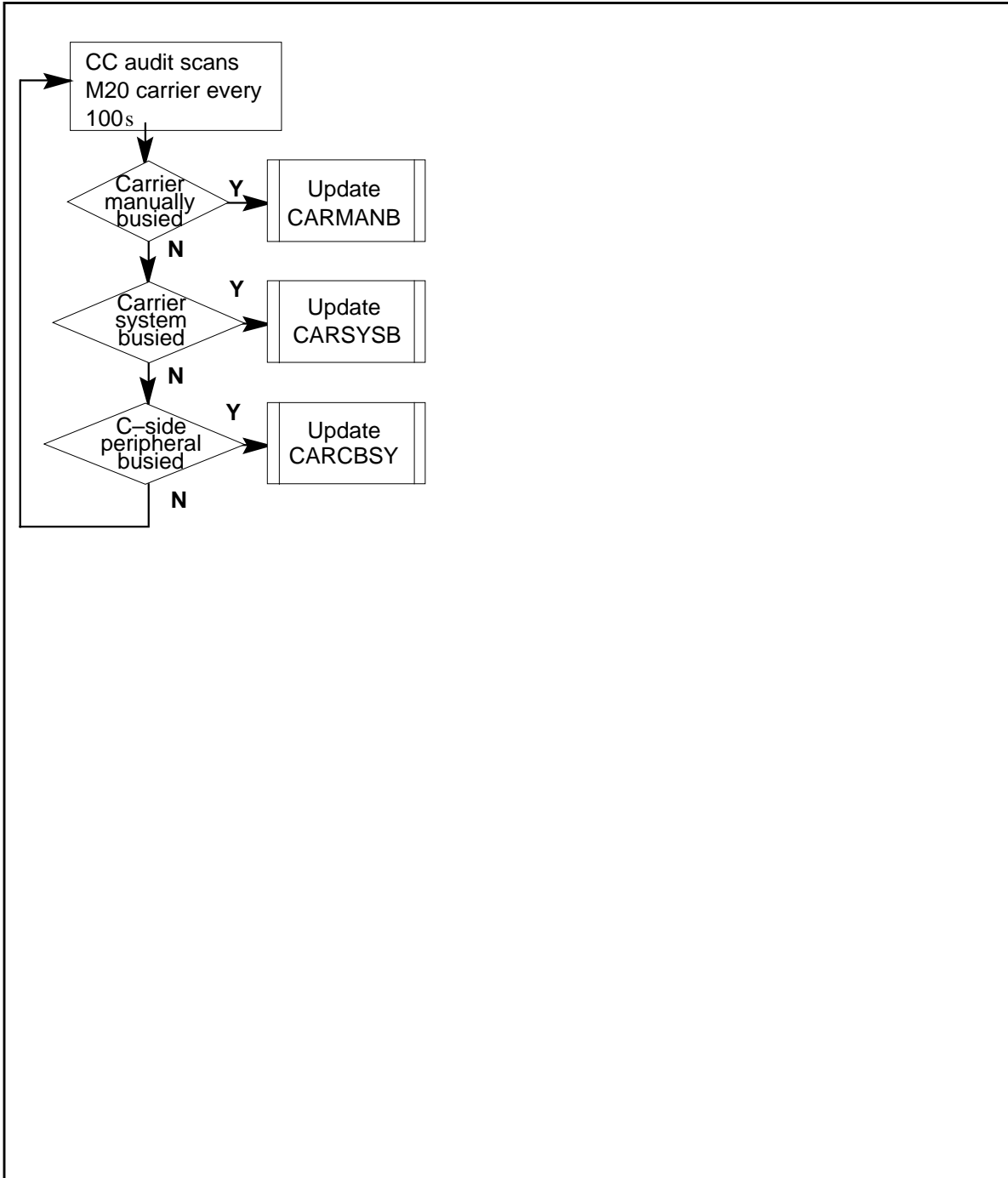

Register AISSERR

Register Alarm indication signal error (AISSERR)

OM group M20CARR1 (continued)

Register AISSERR increases when the central control (CC) generates an alarm because of a fault on an M20 signaling link. The CC detects the fault when a continuous stream of 1's is found on the incoming link. A continuous stream of 1's on the incoming link indicates the link is in a manually busy state. A minimum of one frame of 1's must be received before an alarm indication signal (AIS) is raised.

Register AISSERR release history

Register AISSERR introduced in BCS29.

Associated registers

Register AISSERR increases when the CC detects an AIS fault on an incoming M20 signaling link.

Associated logs

There are no associated logs.

Register AISSFLT

Alarm indication signal fault (AISSFLT)

Register AISSFLT increases when the CC detects an AIS fault on an incoming M20 signaling link. This fault occurs when the CC detects a continuous stream of 1's on the incoming link. A continuous stream of 1's on the incoming link indicates the link is in a manually busy state. At least one frame of 1's must be received before an AIS is raised.

Register AISSFLT release history

Register AISSFLT introduced in BCS29.

Associated registers

Register AISSFLT increases when the CC generates an alarm because of an AIS fault the CC detects on an M20 signaling link.

Associated logs

There are no associated logs.

Register ALERR

Register Alarm error (ALERR)

Register ALERR increases when the CC detects a fault on an M20 signaling link and generates an alarm. The CC detects a fault when a binary 1 is found in bit 2 of timeslot 0. This fault indicates that the incoming 2048 kbits/s signal on the M20 link cannot be received.

OM group M20CARR1 (continued)

Register ALERR release history

Register ALERR introduced in BCS29.

Associated registers

Register ALERR increases when the CC detects a fault on an incoming M20 signaling link.

Associated logs

There are no associated logs.

Register ALFLT

Register Alarm fault (ALFLT)

Register ALFLT increases when the CC detects a fault on an incoming M20 signaling link. This fault occurs when a binary 1 is found in bit 2 of timeslot 0. This fault indicates that the incoming 2048 kbits/s signal on the M20 link cannot be received.

Register ALFLT release history

Register ALFLT introduced in BCS29.

Associated registers

Register ALFLT increases when the CC detects a fault on an M20 signaling link and generates an alarm.

Associated logs

There are no associated logs.

Register CARCBSY

Register Carrier C-side peripheral busy (CARCBSY)

Register CARCBSY updates every 100 [\[hairsp\]](#)s. Register CARCBSY records the amount of time the M20 carrier is in a Core side (C-side) peripheral busy (CBSY) state. The system places the carrier in this state when the C-side peripheral module goes out of service.

Register CARCBSY release history

Register CARCBSY introduced in BCS29.

Associated registers

There are no associated registers.

OM group M20CARR1 (continued)

Associated logs

There are no associated logs.

Register CARMANB

Register Carrier manually busy (CARMANB)

Register CARMANB updates every 100[[hairsp](#)] s. Register CARMANB records the amount of time that the M20 carrier is in a manual-busy (ManB) state. Maintenance personnel place a carrier in a ManB state.

Register CARMANB release history

Register CARMANB introduced in BCS29.

Associated registers

There are no associated registers.

Associated logs

There are no associated logs.

Register CARSYSB

Register Carrier system busied.

Register CARSYSB updates every 100[[hairsp](#)]s. Register CARSYSB records the amount of time that the M20 carrier is in a system busy (SysB) state. The M20 carrier is in a SysB state because of system alarms or faults.

Register CARSYSB release history

Register CARSYSB introduced in BCS29.

Associated registers

There are no associated registers.

Associated logs

There are no associated logs.

Register FAERR

Register Frame alignment error.

Register FAERR increases when the CC generates an alarm because of a frame alignment (FA) fault the CC detects on an M20 signaling link. This fault occurs when a code violation bit is missing or when two bits are not positioned correctly on the link. The two bits are less or more than 125 us apart. The FA

OM group M20CARR1 (continued)

alarm indicates a loss of the incoming signal or a loss of incoming frame alignment.

Register FAERR release history

Register FAERR introduced in BCS29.

Associated registers

Register FAFLT increases when the CC detects an FA fault on an M20 signaling link.

Associated logs

There are no associated logs.

Register FAFLT

Frame alignment fault (FAFLT)

Register FAFLT increases when the CC detects an FA fault on an incoming M20 signaling link. This fault occurs when a code violation bit is missing or when two bits are not positioned correctly on the link. The two bits are less or more than 125 us apart. The result is a loss of the incoming signal.

Register FAFLT release history

Register FAFLT introduced in BCS29.

Associated registers

Register FAERR increases when the CC generates a frame alignment alarm. The CC generates a frame alignment alarm to indicate a loss of the incoming signal or a loss of incoming frame alignment.

Associated logs

There are no associated logs.

Register SLIPPERR

Slip error (SLIPPERR)

Register SLIPPERR increases when the CC generates an alarm because of a slip fault on an M20 signaling link. This fault occurs when a frame of data on the link repeats or slips over.

Register SLIPPERR release history

Register SLIPPERR introduced in BCS29.

OM group M20CARR1 (end)

Associated registers

Register SLIPPFLT increases when the CC detects a slip fault on an incoming M20 signaling link.

Associated logs

There are no associated logs.

Register SLIPPFLT

Register Slip fault (SLIPPFLT)

Register increases when the CC detects a slip fault on an incoming M20 signaling link. This fault occurs when a frame of data on the link repeats or slips over.

Register SLIPPFLT release history

Register SLIPPFLT introduced in BCS29.

Associated registers

Register SLIPPERR increases when the CC generates an alarm because of a slip fault the CC detects on an M20 signaling link.

Associated logs

There are no associated logs.

OM group M20CARR2

OM description

M20 handling group (M20CARR2)

The OM group M20CARR2 provides information about alarms and state changes that occur on M20 handling groups. A handling group consists of six of the 30 voice/data channels on an M20 carrier. The M20 carrier supports communication at a rate of 2048 kbits/s between the DMS system and the Japanese network.

Release history

OM group M20CARR2 introduced in BCS29.

Registers

The OM group M20CARR2 registers appear on the MAP terminal as follows:

TNR11ERR	TNR21ERR	TNR12ERR	TNR22ERR
TNR13ERR	TNR23ERR	TNR14ERR	TNR24ERR
TNR15ERR	TNR25ERR	TNR11FLT	TNR21FLT
TNR12FLT	TNR22FLT	TNR13FLT	TNR23FLT
TNR14FLT	TNR24FLT	TNR15FLT	TNR25FLT
H1SYSB	H2SYSB	H3SYSB	H4SYSB
H5SYSB	H1MANB	H2MANB	H3MANB
H4MANB	H5MANB	HGCFL	

Group structure

The OM group M20CARR2 provides one tuple per office.

Key field:

There is no key fields.

Info field:

M200MINF

Associated OM groups

There are no associated OM groups.

Associated functional groups

There are no associated functional groups.

OM group M20CARR2 (continued)

Associated functionality codes

The associated functionality code for OM group M20CARR2 appears in the following table:

Functionality	Code
M20 Maintenance	NTXH11AA

OM group M20CARR2 (continued)

OM group M20CARR2 registers

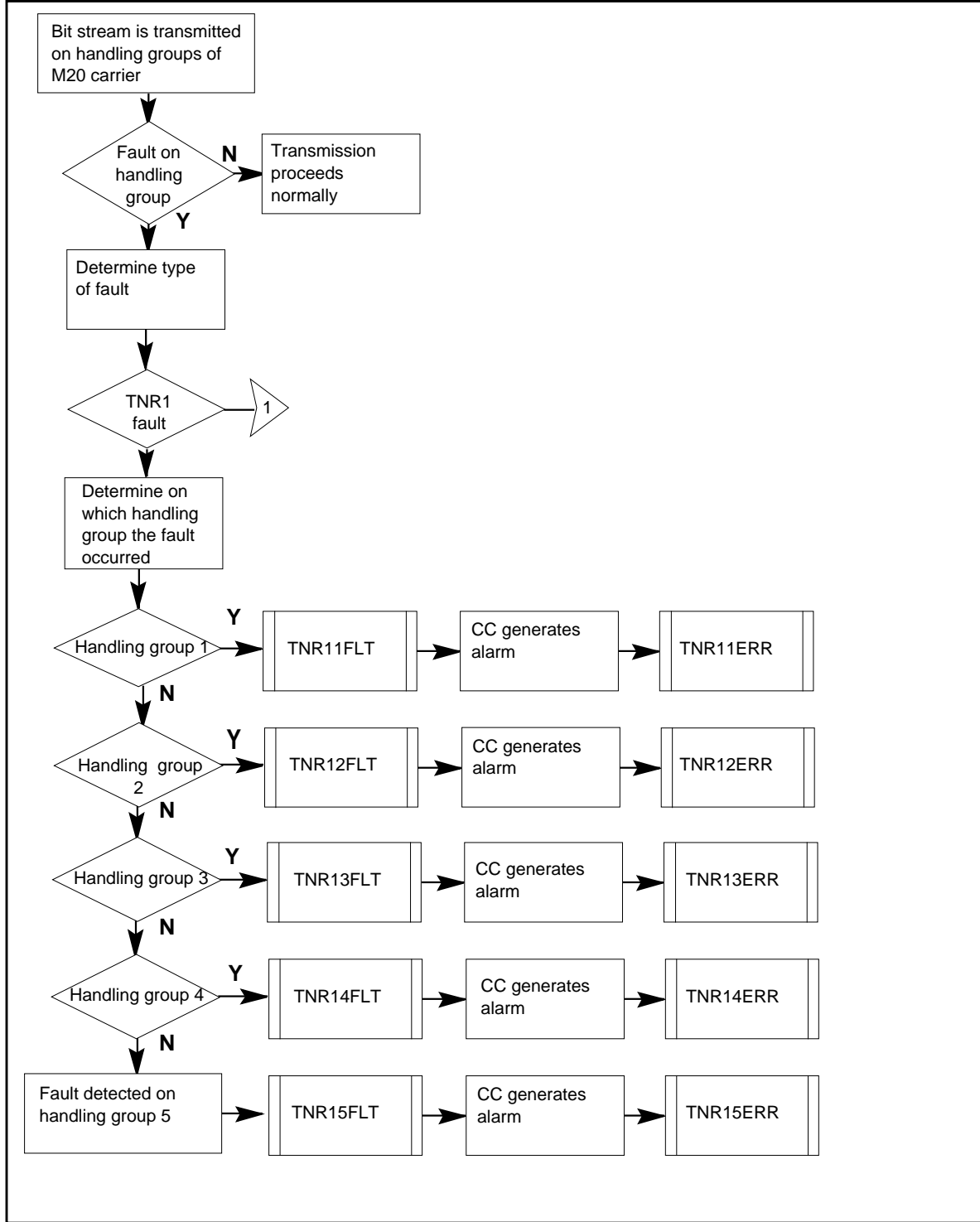

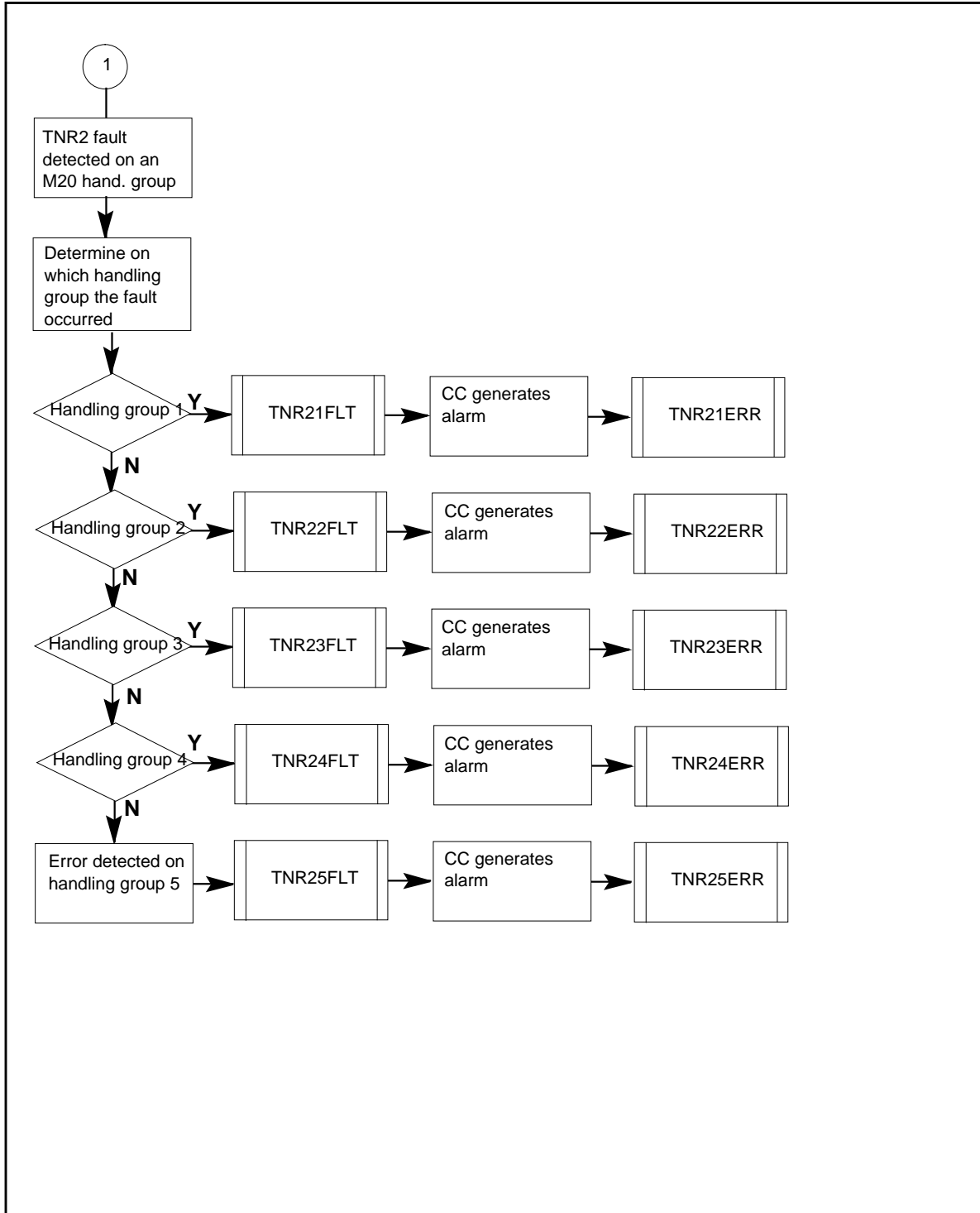
OM group M20CARR2 (continued)**OM group M20CARR2 registers (continued)**

OM group M20CARR2 (continued)

OM group M20CARR2 usage registers (continued)

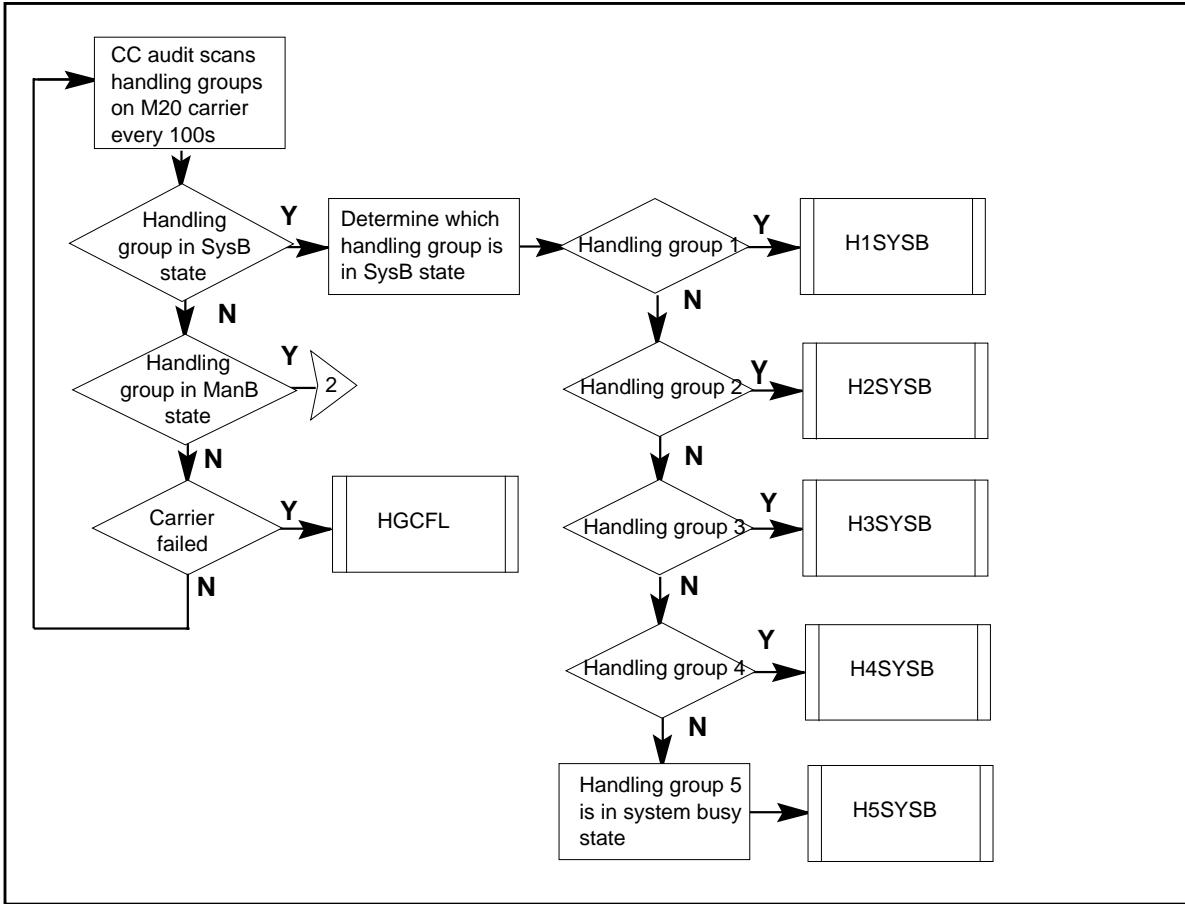

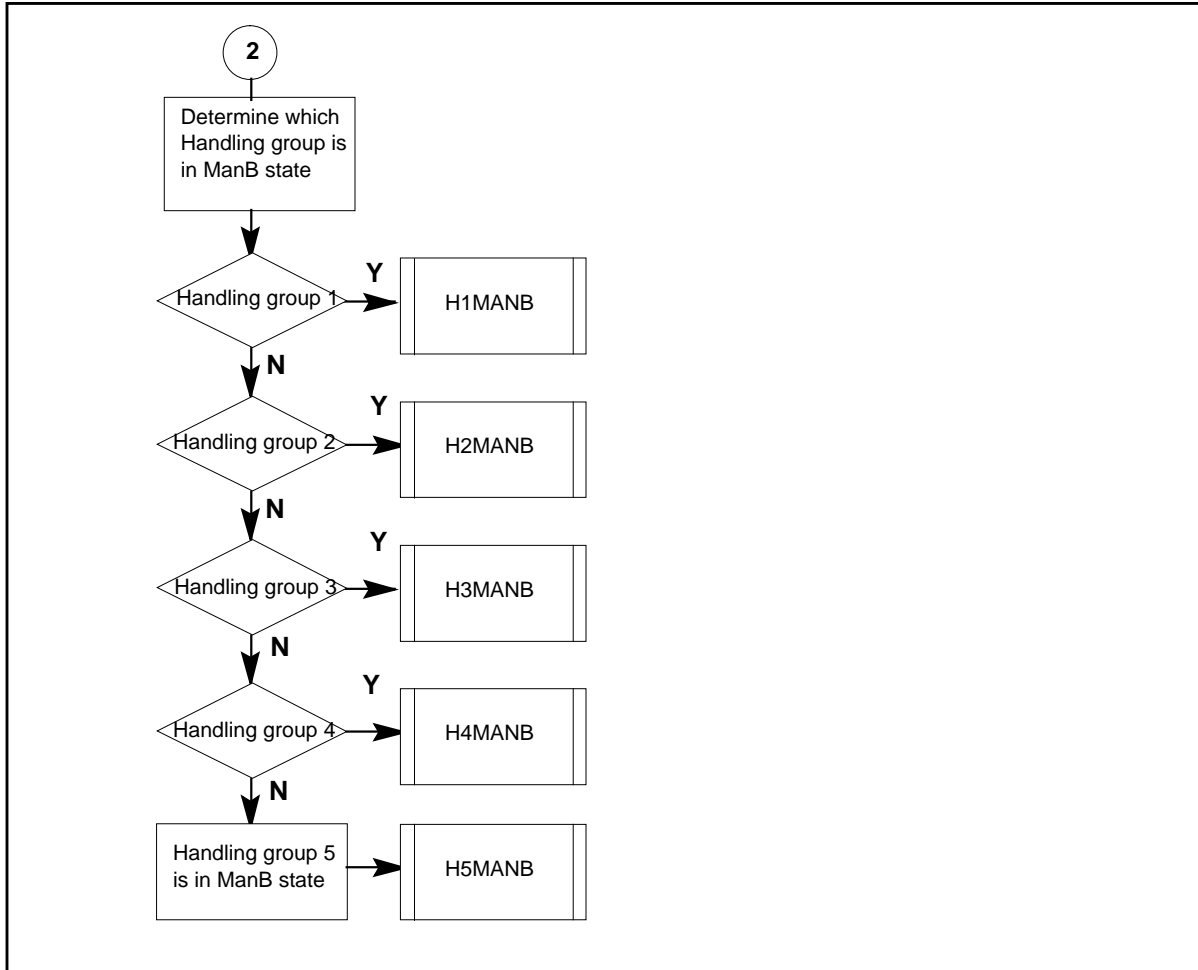
OM group M20CARR2 (continued)**OM group M20CARR2 usage registers (continued)****Register H1MANB**

Handling group 1 manually busied (H1MANB)

Register H1MANB updates every 100s. Register H1MANB records the amount of time handling group 1 of an M20 carrier is in a manual-busy state. Handling group 1 is in a manual busy state so that telephone company personnel can perform maintenance tasks on the handling group. An M20 carrier is in an in-service trouble (ISTb) state when a minimum of one of the handling groups is manual busy.

Register H1MANB release history

Register H1MANB introduced in BCS29.

OM group M20CARR2 (continued)

Associated registers

There are no associated registers.

Associated logs

There are no associated logs.

Register H1SYSB

Handling group 1 system busied (H1SYSB)

Register H1SYSB updates every 100s. Register H1SYSB records the amount of time handling group 1 of an M20 carrier is in a system busy state. Handling group 1 can be in a system busy state. An unsolicited message from the extended peripheral module (XPM) also places handling group 1 in a system busy state. An M20 carrier is in an ISTb state when a minimum of one of the handling groups is system busy

Register H1SYSB release history

Register H1SYSB introduced in BCS29.

Associated registers

There are no associated registers.

Associated logs

There are no associated logs.

Register H2MANB

Handling group 2 manually busied.

Register H2MANB updates every 100s. Register H2MANB records the amount of time handling group 2 of an M20 carrier is in a manual busy state. Handling group 2 is in a manual busy state so that telephone company personnel can perform maintenance tasks. Telephone company personnel perform maintenance tasks on the handling group. An M20 carrier is in an ISTb state when a minimum of one of the handling groups manual busies.

Register H2MANB release history

Register H2MANB introduced in BCS29.

Associated registers

There are no associated registers.

Associated logs

There are no associated logs.

OM group M20CARR2 (continued)

Register H2SYSB

Handling group 2 system busied (H2SYSB)

Register H2SYSB updates every 100s. Register H2SYSB records the amount of time handling group 2 of an M20 carrier is in a system busy state. A carrier fault that the CC detects during an audit places handling group 2 in a system busy state. An unsolicited message from the XPM also places handling group 2 in a system busy state. An M20 carrier is in an ISTb state when a minimum of one of the handling groups is system busy.

Register H2SYSB release history

Register H2SYSB introduced in BCS29.

Associated registers

There are no associated registers.

Associated logs

There are no associated logs.

Register H3MANB

Handling group 3 manually busied (H3MANB)

Register H3MANB updates every 100s. Register H3MANB records the amount of time handling group 3 of an M20 carrier is in a manual busy state. Handling group 3 is in a manually busy state so that telephone company personnel can perform maintenance tasks on the handling group. An M20 carrier is in an ISTb state when a minimum of one of the handling groups is manually busy.

Register H3MANB release history

Register H3MANB introduced in BCS29.

Associated registers

There are no associated registers.

Associated logs

There are no associated logs.

Register H3SYSB

Handling group 3 system busied (H3SYSB)

Register H3SYSB updates every 100s. Register H3SYSB records the amount of time handling group 3 of an M20 carrier is in a system busy state. A carrier

OM group M20CARR2 (continued)

fault that the CC detects during an audit places handling group 3 in a system busy state. An unsolicited message from the XPM also places handling group 3 in a system busy state. An M20 carrier is in an ISTb state when a minimum of one of the handling groups is system busy.

Register H3SYSB release history

Register H3SYSB introduced in BCS29.

Associated registers

There are no associated registers.

Associated logs

There are no associated logs.

Register H4MANB

Handling group 4 manually busied (H4MANB)

Register H4MANB updates every 100s. Register H4MANB records the amount of time handling group 4 of an M20 carrier is in a manual busy state. Handling group 4 is in a manually busy state so that telephone company personnel can perform maintenance tasks on the handling group. An M20 carrier is in an ISTb state when a minimum of one of the handling groups is manually busy.

Register H4MANB release history

Register H4MANB introduced in BCS29.

Associated registers

There are no associated registers.

Associated logs

There are no associated logs.

Register H4SYSB

Handling group 4 system busied (H4SYSB)

Register H4SYSB updates every 100s. Register H4SYSB records the amount of time handling group 4 of an M20 carrier is in a system busy state. A carrier fault that CC detects during an audit places handling group 4 in a system busy state. An unsolicited message from the XPM. An M20 carrier is in an ISTb state when a minimum of one of the handling groups is system busy.

OM group M20CARR2 (continued)

Register H4SYSB release history

Register H4SYSB introduced in BCS29.

Associated registers

There are no associated registers.

Associated logs

There are no associated logs.

Register H5MANB

Handling group 5 manually busied (H5MANB)

Register H5MANB updates every 100s. Register H5MANB records the amount of time handling group 5 of an M20 carrier is in a manual busy state. Handling group 5 is in a manual busy state so that telephone company personnel can perform maintenance tasks on the handling group. An M20 carrier is in an ISTb state when a minimum of one of the handling groups is manually busy.

Register H5MANB release history

Register H5MANB introduced in BCS29.

Associated registers

There are no associated registers.

Associated logs

There are no associated logs.

Register H5SYSB

Handling group 5 system busied (H5SYSB)

Register H5SYSB updates every 100s. Register H5SYSB records the amount of time handling group 5 of an M20 carrier is in a system busy state. Handling group 5 can be in a system busy state. An unsolicited message from the XPM also places handling group 5 in a system busy state. An M20 carrier is in an ISTb state when a minimum of one of the handling groups system busy.

Register H5SYSB release history

Register H5SYSB introduced in BCS29.

Associated registers

There are no associated registers.

OM group M20CARR2 (continued)

Associated logs

There are no associated logs.

Register HGCFL

Handling group carrier failed (HGCFL)

Register HGCFL updates every 100s. Register HGCFL records the amount of time that an M20 carrier is in a carrier failed (CFL) state. An M20 carrier is in a CFL state because of the failure of the handling groups.

Register HGCFL release history

Register HGCFL introduced in BCS29.

Associated registers

There are no associated registers.

Associated logs

There are no associated logs.

Register TNR11ERR

Error count for TNR1 alarm for handling group 1 (TNR11ERR)

Register TNR11ERR increases when the CC generates a TNR1 frame alignment alarm. The CC generates a TNR1 frame alignment alarm when the CC detects a TNR1 fault on handling group 1 of an M20 carrier. The TNR1 faults occur when the correct sequence of framing bits in a handling group is lost.

Register TNR11ERR release history

Register TNR11ERR introduced in BCS29.

Associated registers

Register TNR11FLT increases when the CC detects a TNR1 fault on handling group 1 of an M20 carrier.

Associated logs

There are no associated logs.

Register TNR11FLT

Fault count for TNR1 alarm for handling group 1 (TNR11FLT)

Register TNR11FLT increases when the CC detects a TNR1 fault on handling group 1 of an M20 carrier. A TNR1 fault occurs when the correct sequence of

OM group M20CARR2 (continued)

framing bits in a handling group is lost. The group is in a system busy state when the correct sequence of framing bits is lost.

Register TNR11FLT release history

Register TNR11FLT introduced in BCS29.

Associated registers

Register TNR11ERR increases when the CC generates a TNR1 frame alignment alarm. The CC generates a TNR1 frame alignment alarm when detecting a TNR1 fault on handling group 1 of an M20 carrier.

Associated logs

There are no associated logs.

Register TNR12ERR

Error count for TNR1 alarm for handling group 2 (TNR11FLT)

Register TNR12ERR increases when the CC generates a TNR1 frame alignment alarm. The CC generates a TRN1 frame alignment alarm when the CC detects a TNR1 fault on handling group 2 of an M20 carrier. TNR1 faults occur when the correct sequence of framing bits in a handling group is lost.

Register TNR12ERR release history

Register TNR12ERR introduced in BCS29.

Associated registers

Register TNR12FLT increases when the CC detects a TNR1 fault on handling group 2 of an M20 carrier.

Associated logs

There are no associated logs.

Register TNR12FLT

Fault count for TNR1 alarm for handling group 2 (TNR12FLT)

Register TNR12FLT increases when the CC detects a TNR1 fault on handling group 2 of an M20 carrier. A TNR1 fault occurs when the correct sequence of framing bits in a handling group is lost. The group is in a system busy state when the correct sequence of framing bits is lost.

Register TNR12FLT release history

Register TNR12FLT introduced in BCS29

OM group M20CARR2 (continued)

Associated registers

The TNR12ERR increases when the CC generates a TNR1 frame alignment alarm. The CC generates a TRN1 frame alignment alarm when the CC detects a TNR1 fault on handling group 2 of an M20 carrier.

Associated logs

There are no associated logs.

Register TNR13ERR

Error count for TNR1 alarm for handling group 3 (TNR13ERR)

Register TNR13ERR increases when the CC generates a TNR1 frame alignment alarm. The CC generates a TNR1 frame alignment alarm when the CC detects TNR1 fault on handling group 3 of an M20 carrier. TNR1 faults occur when the correct sequence of framing bits in a handling group is lost.

Register TNR13ERR release history

Register TNR13ERR introduced in BCS29.

Associated registers

Registers TNR13FLT increases when the CC detects a TNR1 fault on the handling group 3 of an M20 carrier.

Associated logs

There are no associated logs.

Register TNR13FLT

Fault count for TNR1 alarm for handling group 3 (TNR13FLT)

Register TNR13FLT increases when the CC detects a TNR1 fault on handling group 3 of an M20 carrier. A TNR1 fault occurs when the correct sequence of framing bits in a handling group is lost. The group is in a system busy state when the correct sequence of framing bits in a handling group is lost.

Register TNR13FLT release history

Register TNR13FLT introduced in BCS29.

Associated registers

Register TNR13ERR increases when the CC generates a TNR1 frame alignment alarm. The CC generates a TNR1 frame alignment alarm when the CC detects a TNR1 fault on handling group 3 of an M20 carrier.

OM group M20CARR2 (continued)

Associated logs

There are no associate logs.

Register TNR14ERR

Error count for TNR1 alarm for handling group 4.

Register TNR14ERR increases when the CC generates a TNR1 frame alignment alarm. The CC generates a TNR1 frame alignment alarm when detecting a TNR1 fault on handling group 4 of an M20 carrier. TNR1 faults occur when the correct sequence of framing bits in a handling group is lost.

Register TNR14ERR release history

Register TNR14ERR introduced in CS29.

Associated registers

Register TNR14FLT increases when the CC detects a TNR1 fault is on handling group 4 of an M20 carrier.

Associated logs

There are no associated logs.

Register TNR14FLT

Fault count for TNR1 alarm for handling group 4 (TNR14FLT)

Register TNR14FLT increases when the CC detects a TNR1 fault on handling group 4 of an M20 carrier. A TNR1 fault occurs when the correct sequence of framing bits in a handling group is lost. The group is in a system busy state when the correct sequence of framing bits is lost.

Register TNR14FLT release history

Register TNR14FLT introduced in BCS29.

Associated registers

Register TNR14ERR increases when the CC generates a TNR1 frame alignment alarm. The CC generates a TNR1 frame alignment alarm when the CC detects a TNR1 fault on handling group 4 of an M20 carrier.

Associated logs

There are no associated logs.

Register TNR15ERR

Error count for TNR1 alarm for handling group 5 (TNR15ERR)

OM group M20CARR2 (continued)

Register TNR15ERR increases when the CC generates a TNR1 frame alignment alarm. The CC generates a TRN1 frame alignment alarm when the CC detects a TNR1 fault on handling group 5 of an M20 carrier. TNR1 faults occur when the correct sequence of framing bits in a handling group is lost.

Register TNR15ERR release history

Register TNR15ERR introduced in BCS29.

Associated registers

Register TNR15FLT increases when the Cc detects a TNR1 fault on handling group 5 of an M20 carrier.

Associated logs

There are no associated logs.

Register TNR15FLT

Fault count for TNR1 alarm for handling group 5 (TNR15FLT)

Register TNR15FLT increases when a the CC detects a TNR1 fault is detected on handling group 5 of an M20 carrier. A TNR1 fault occurs when the correct sequence of framing bits in a handling group is lost. The group is in a system busy state when the correct sequence of framing bits is lost.

Register TNR15FLT release history

Register TNR15FLT introduced in BCS29.

Associated registers

Register TNR15ERR increases when CC generates a TNR1 frame alignment alarm. The CC generates a TNR1 frame alignment alarm when detecting a TNR1 fault on handling group 5 of an M20 carrier.

Associated logs

There are no associated logs.

Register TNR21ERR

Error count for TNR2 alarm for handling group 1 (TNR21ERR)

Register TNR21ERR increases when the CC generates a TNR2 alarm. The CC generates a TNR2 alarm when the CC detects a TNR2 fault on handling group 1 of an M20 carrier. The CC uses the signaling processor (SP) alarm bits on the handling group bit streams to detect TNR2 faults. These faults occur when the remote M20 multiplexer cannot receive signaling information from the local M20 multiplexer.

OM group M20CARR2 (continued)

Register TNR21ERR release history

Register TNR21ERR introduced in BCS29.

Associated registers

Register TNR21FLT increases when the CC detects a TNR2 fault is detected on handling group 1 of an M20 carrier.

Associated logs

There are no associated logs.

Register TNR21FLT

Fault count for TNR2 alarm for handling group 1.

Register TNR21FLT increases when the CC detects a TNR2 fault on handling group 1 of an M20 carrier. The SP alarm bits on the handling group bit streams detect TNR2 faults. These faults occur when the remote M20 multiplexer cannot receive signalling information from the local M20 multiplexer.

Register TNR21FLT release history

Register TNR21FLT introduced in BCS29.

Associated registers

Register TNR21ERR increases when the CC generates a TNR2 alarm. The CC generates a TNR2 alarm when the CC detects a TNR2 fault on handling group 1 of an M20 carrier.

Associated logs

There are no associated logs.

Register TNR22ERR

Error count for TNR2 alarm for handling group 2.

Register TNR22ERR increases when the CC generates a TNR2 alarm. The CC generates a TNR2 alarm when the CC detects a TNR2 fault on handling group 2 of an M20 carrier. The CC uses the SP alarm bits on the handling group bit streams to detect TNR2 faults. These faults occur when the remote M20 multiplexer cannot receive signaling information from the local M20 multiplexer.

Register TNR22ERR release history

Register TNR22ERR introduced in BCS29.

OM group M20CARR2 (continued)

Associated registers

Register TNR22FLT increases when the CC detects a TNR2 fault is detected on handling group 2 of an M20 carrier.

Associated logs

There are no associated logs.

Register TNR22FLT

Fault count for TNR2 alarm for handling group 2 (TNR22FLT)

Register TNR22FLT increases when the CC detects a TNR2 fault on handling group 2 of an M20 carrier. The CC uses the SP alarm bits on the handling group bit streams to detect TNR2 faults. These faults occur when the remote M20 multiplexer cannot receive signaling information from the local M20 multiplexer.

Register TNR22FLT release history

Register TNR22FLT introduced in BCS29.

Associated registers

Register TNR22ERR increases when the CC generates a TNR2 alarm. The CC generates a TNR2 alarm when the CC detects a TNR2 fault on handling group 2 of an M20 carrier.

Associated logs

There are no associated logs.

Register TNR23ERR

Error count for TNR2 alarm for handling group 3 (TNR23ERR)

Register TNR23ERR increases when the CC generates a TNR2 alarm. The CC generates a TNR2 alarm when the CC detects a TNR2 fault on handling group 3 of an M20 carrier. The CC uses the SP alarm bits on the handling group bit streams to detect TNR2 faults. These faults occur when the remote M20 multiplexer cannot receive signaling information from the local M20 multiplexer.

Register TNR23ERR release history

Register TNR23ERR introduced in BCS29.

Associated registers

Register TNR23FLT increases when the CC detects a TNR2 fault on handling group 3 of an M20 carrier.

OM group M20CARR2 (continued)

Associated logs

There are no associated logs.

Register TNR23FLT

Fault count for TNR2 alarm for handling group 3 (TNR23FLT)

Register TNR23FLT increases when the CC detects a TNR2 fault on handling group 3 of an M20 carrier. The CC uses the SP alarm bits on the handling group bit streams to detect TNR2 faults. These faults occur when the remote M20 multiplexer cannot receive signaling information from the local M20 multiplexer.

Register TNR23FLT release history

Register TNR23FLT introduced in BCS29.

Associated registers

Register TNR23ERR increases when the CC generates a TNR2 alarm. The CC generates a TNR2 alarm when detecting a TNR2 fault on handling group 3 of an M20 carrier.

Associated logs

There are no associated logs.

Register TNR24ERR

Error count for TNR2 alarm for handling group 4.

Register TNR24ERR increases when the CC generates a TNR2 alarm. The CC generates a TNR2 alarm when the CC detects a TNR2 fault on handling group 4 of an M20 carrier. The CC uses the SP alarm bits on the handling group bit streams to detect TNR2 faults. These faults occur when the remote M20 multiplexer cannot receive signaling information from the local M20 multiplexer.

Register TNR24ERR release history

Register TNR24ERR introduced in BCS29.

Associated registers

Register TNR24FLT increases when the CC detects a TNR2 fault on handling group 4 of an M20 carrier.

Associated logs

There are no associated logs.

OM group M20CARR2 (continued)

Register TNR24FLT

Fault count for TNR2 alarm for handling group 4.

Register TNR24FLT increases when the CC detects a TNR2 fault on handling group 4 of an M20 carrier. The CC uses the SP alarm bits on the handling group bit streams to detect TNR2 faults. These faults occur when the remote M20 multiplexer cannot receive signaling information from the local M20 multiplexer.

Register TNR24FLT release history

Register TNR24FLT introduced in BCS29.

Associated registers

Register TNR24ERR increases when the CC generates a TNR2 alarm. The CC generates a TNR2 alarm when the CC detects a TNR2 fault on handling group 4 of an M20 carrier.

Associated logs

There are no associated logs.

Register TNR25ERR

Error count for TNR2 alarm for handling group 5 (TNR25ERR)

Register TNR25ERR increases when the CC generates a TNR2 alarm. The CC generates a TNR2 alarm when the CC detects a TNR2 fault on handling group 5 of an M20 carrier. The SP alarm bits on the handling group bit streams detect TNR2 faults. These faults occur when the remote M20 multiplexer cannot receive signaling information from the local M20 multiplexer.

Register TNR25ERR release history

Register TNR25ERR introduced in BCS29.

Associated registers

Register TNR25FLT increases when the CC detects a TNR2 fault on handling group 5 of an M20 carrier.

Associated logs

There are no associated logs.

Register TNR25FLT

Fault count for TNR2 alarm for handling group 5 (TNR25FLT)

OM group M20CARR2 (end)

Register TNR25FLT increases when the CC detects a TNR2 fault on handling group 5 of an M20 carrier. The CC uses the SP alarm bits on the handling group bit streams to detect TNR2 faults. These faults occur when the remote M20 multiplexer cannot receive signaling information from the local M20 multiplexer.

Register TNR25FLT release history

Register TNR25FLT introduced in BCS29.

Associated registers

Register TNR25ERR increases when the CC generates a TNR2 alarm. The CC generates a TNR2 alarm when the CC detects a TNR2 fault on handling group 5 of an M20 carrier.

Associated logs

There are no associated logs.

OM group MACHCONG

OM description

Machine congestion

Machine congestion (MACHCONG) provides information on MC1 and MC2 machine congestion levels in the central control complex (CCC). MC1 and MC2 congestion levels occur in the CCC when predetermined threshold values are exceeded. MC1 and MC2 are defined by the same threshold values that determine when the first- and second-level internal dynamic overload controls (IDOC) are activated.

IDOC is a network management (NWM) feature that generates control signals when internal overload is detected in a switch. The NWM system provides supervision and control of switching office networks to ensure the maximum flow of traffic during overload conditions.

MACHCONG has three registers:

- one usage register that records whether the MC1 and MC2 congestion levels are reached for call processing or the multifrequency queue
- two peg registers that are incremented if the MC1 and MC2 congestion levels are reached for call processing or the multifrequency (MF) queue

The data supplied by MACHCONG is used to assess how well the CCC is processing calls.

Release history

OM group MACHCONG was introduced in BCS23.

BCS30

Software change to provide usage counts either in CCS or deci-erlangs.

Registers

OM group MACHCONG registers display on the MAP terminal as follows:

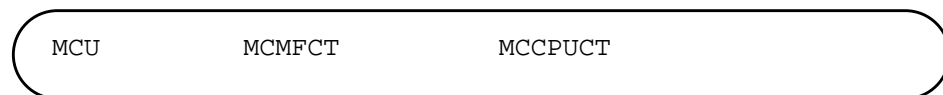

Group structure

OM group MACHCONG provides one tuple for each key.

OM group MACHCONG (continued)

Key field:

nwm_mc_level is a value (MC1, MC2, or MC3) that represents the level of machine congestion. MC1 represents a lower level of machine congestion than MC2, but both levels are triggered by the same causes. MC3 represents the level of machine congestion that results when an office cannot perform call processing because of a dead system or a system restart. The registers in MACHCONG do not count level MC3. The threshold values must be datafilled in table NWMIDOC to specify when MC1 and MC2 levels are reached and IDOC levels one and two are activated.

Info field:

None

Associated OM groups

None

Associated functional groups

The following functional groups are associated with OM group MACHCONG:

- DMS-100 Local
- DMS-200 Toll
- DMS-250 Toll/Tandem
- DMS-300 Gateway
- DMS-100 International
- DMS-MTX Mobile Telephone Exchange
- Network Management Internal Dynamic Overload Control

Associated functionality codes

The functionality codes associated with OM group MACHCONG are shown in the following table.

Functionality	Code
NTX060AB	Network Management

OM group MACHCONG (continued)

OM group MACHCONG MC1 and MC2 congestion level registers

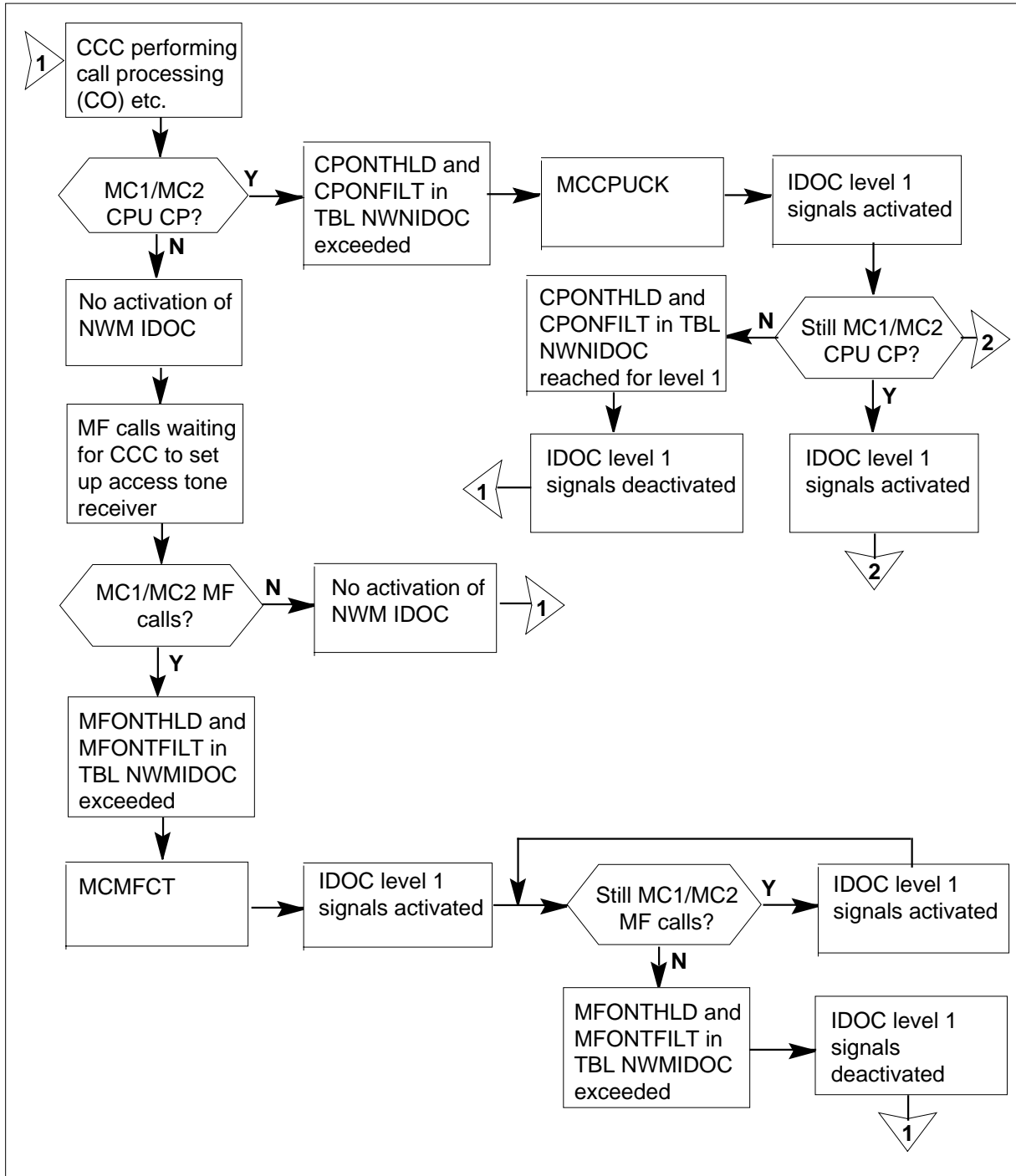

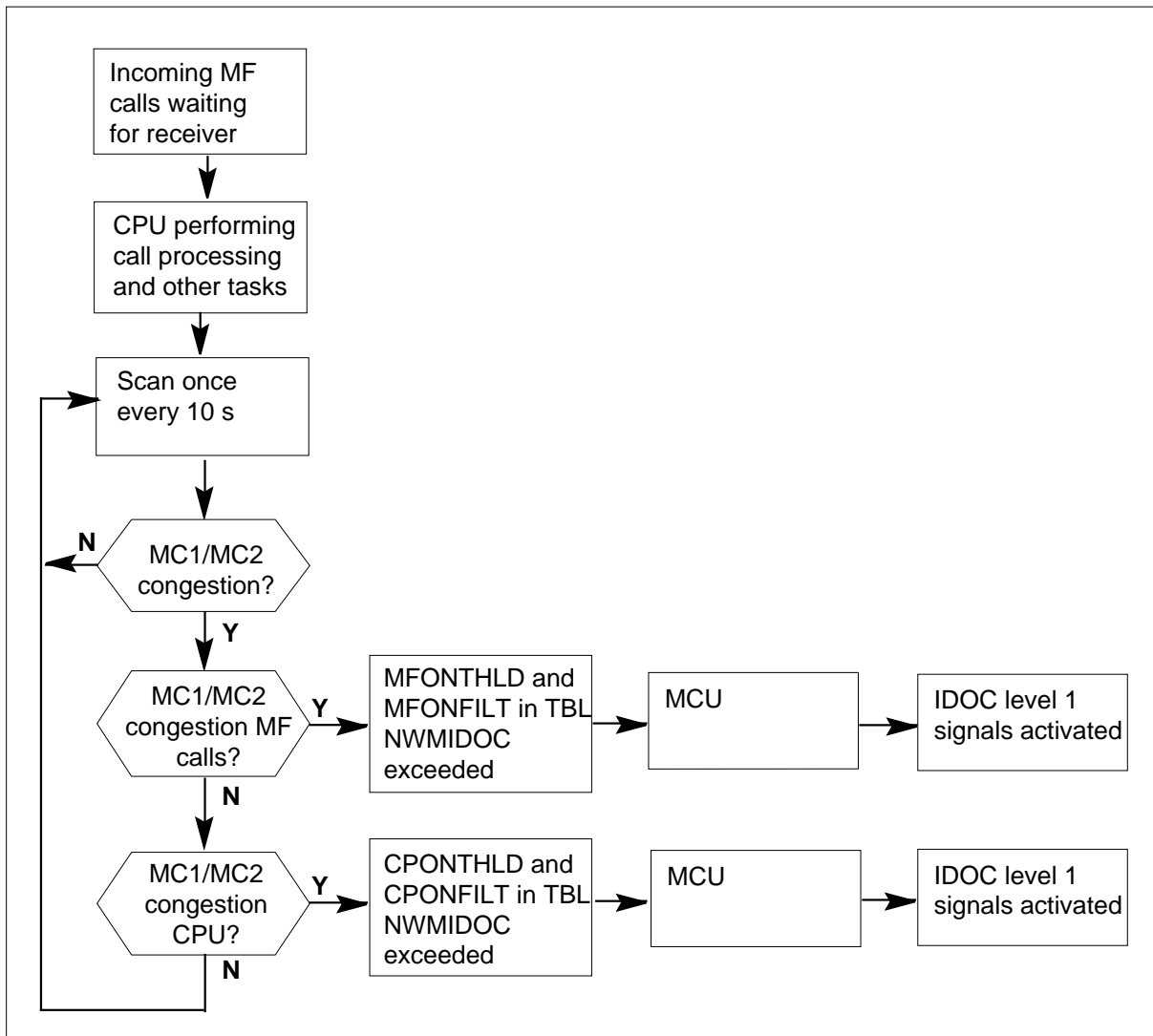
OM group MACHCONG (continued)**OM group MACHCONG MC1 and MC2 usage registers****Register MCCPUCT**

Register Machine congestion CPU count

Register Machine congestion CPU count (MCCPUCT) is incremented if the MC1 and MC2 congestion levels are reached for CPU call processing. CPU congestion occurs when the percentage of time the CPU spends on call processing exceeds the predetermined threshold values in table NWMIDOC. At maximum speed, MCCPUCT is incremented at one-minute intervals.

Threshold values must be datafilled in table NWMIDOC to specify the percentage of time that the CPU can devote to call processing before the MC1

OM group MACHCONG (continued)

and MC2 congestion levels are reached and IDOC levels one and two are activated.

Register MCCPUCT release history

Register MCCPUCT was introduced in BCS23.

Associated registers

None

Associated logs

None

Extension registers

None

Register MCMFCT

Register Machine congestion multifrequency count

Register Machine congestion multifrequency count (MCMFCT) is incremented if the MC1 and MC2 congestion levels are reached for incoming multifrequency (MF) calls that are queued while the CCC sets up a connection to a tone receiver. At maximum speed, MCMFCT is incremented at one-minute intervals.

Threshold values must be datafilled in table NWMIDOC to specify when MC1 and MC2 congestion levels are reached and IDOC levels one and two are activated.

Register MCMFCT release history

Register MCMFCT was introduced in BCS23.

Associated registers

None

Associated logs

None

Extension registers

None

Register MCU

Register Machine congestion usage

OM group MACHCONG (end)

Register Machine congestion usage (MCU) is a usage register. The scan rate is fast: 10 seconds. MCU records whether the MC1 and MC2 congestion levels have been reached for:

- incoming multifrequency calls that are queued until the CCC sets up a connection to a tone receiver
- CPU call processing

Congestion occurs during CPU call processing when the percentage of time the CPU spends on call processing exceeds the predetermined threshold values in table NWMIDOC.

Threshold values must be datafilled in table NWMIDOC to specify when MC1 and MC2 congestion levels are reached and IDOC levels one and two are activated.

Register MCU release history

Register MCU was introduced in BCS23.

BCS30

Software change to provide usage counts either in CCS or deci-erlangs.

Associated registers

None

Associated logs

None

Extension registers

None

Digital Switching Systems

UCS DMS-250

Operational Measurements Reference Manual
(Volume 1 of 2)

© 1998-2001 Northern Telecom
All rights reserved.

NORTHERN TELECOM CONFIDENTIAL: The information contained herein is the property of Nortel Networks and is strictly confidential. Except as expressly authorized in writing by Nortel Networks, the holder shall keep all information contained herein confidential, shall disclose the information only to its employees with a need to know, and shall protect the information, in whole or in part, from disclosure and dissemination to third parties with the same degree of care it uses to protect its own confidential information, but with no less than reasonable care. Except as expressly authorized in writing by Nortel Networks, the holder is granted no rights to use the information contained herein.

Nortel Networks, the Nortel Networks logo, the Globemark, How the World Shares Ideas, and Unified Networks are trademarks of Nortel Networks.

Publication number: 297-2621-814
Product release: UCS15
Document release: Standard 10.03
Date: May 2001
United States of America