

Critical Release Notice

Publication number: 297-8021-351
Publication release: Standard 12.02

Attention!

The North America DMS-100 Data Schema Reference Manual, 297-8021-351, will continue to be updated and provided in the North America - DMS NTP collection.

The content of this customer NTP supports the SN09 (DMS) software release.

Bookmarks used in this NTP highlight the changes between the NA015 baseline and the SN08 (DMS) release. The bookmarks provided are color-coded to identify release-specific content changes. NTP volumes that do not contain bookmarks indicate that the NA015 baseline remains unchanged and is valid through the SN08 (DMS) release.

Bookmark Color Legend

Black: Applies to content for the NA015 baseline that is valid through the current release.

Red: Applies to new or modified content for NA017 that is valid through the current release.

Blue: Applies to new or modified content for NA018 (SN05 DMS) that is valid through the current release.

Green: Applies to new or modified content for SN06 (DMS) that is valid through the current release.

Purple : Applies to new or modified content for SN07 (DMS) that is valid through the current release.

Pink: Applies to new or modified content for the SN08 (DMS) that is valid through the current release.

Orange: Applies to new or modified content for SN09 (DMS) that is valid through the current release.

Attention!

Adobe ® Acrobat ® Reader ™ 5.0 or higher is required to view bookmarks in color.

Publication History

Note: Refer to the NA015 baseline document for Publication History prior to the NA017 software release.

January 2006

Standard NTP release 12.02 for the SN09 (DMS) software release.

Volume 1

Modified data schema – AMAOPTS (A00009252)

Volume 4

Modified data schema – ESAPXLA (Q01228425-01)

Volume 6

Modified data schema – IPNETWRK (Q01215905 and Q01227402)

Volume 7

Modified data schema – LNSMTCE (Q00959081)

Volume 9

New data schema – PATHSET (modified by Q01077097)

New data schema – SBSRMINV (Q01063949)

Volume10

New data schema – SERVIRINV (Q01063949)

Volume12

Deleted the term TBD, which occurred in two places in this volume.

September 2005

Preliminary NTP release 12.01 for the SN09 (DMS) software release.

Volume 1

Modified data schema – AMAOPTS (A00009252, A00009508); ANNMEMS, ANNPHLST (A00009013)

Volume 8

Modified data schema – OAFUNDEF (A00009012)

Volume 9

Modified data schema – SCAICOMS (A00009078)

Volume 11

Modified data schema – TOPSFTR (A00009012)

Volume 12

Modified data schema – TRKSGRP type ISDN (Q01112597)

Modified data schema – XPMIPMAP (A00009011)

August 2005

Standard NTP release 11.03 for the SN08 (DMS) software release.

Volume 5

Modified data schema – IBNFEAT feature SimRing

Volume 6

Modified data schema – KSETFEAT feature SimRing

Volume 7

Modified data schema – LTCINV

Volume 11

New data schema – TOPSMCDB

Modified data schema – TOPSTOPT

June 2005

Standard NTP release 11.02 for the SN08 (DMS) software release.

The following Data Schema content is updated for the SN08 (DMS) release. Content provided in this NTP is not superseded by content provided in the replacement NTP as indicated for the Preliminary release.

Volume 3

New data schema – CUSTSTN option CNDBO

Volume 4

Modified data schema – EADAS

Volume 6

New data schema – KSETINV

New data schema – LCMINV

Volume 8

New data schema – NSCDEFS

New data schema – NSCPMAP

March 2005

Preliminary NTP release 11.01 for the SN08 (DMS) software release.

The following updated Data Schema content is provided in the Carrier VoIP Operational Configuration: Data Schema Reference NTP, NN10324-509. The content provided in NTP 297-8021-351 is superseded by the content provided in NTP NN10324-509.

ACDMISPL
CGBLDADD
CGBLDDGL
CGBLDDIG
CGBLDNI
CGBLDPI
CGPNBLDR
CUSTSTN_OPTION_DBO
EDAS
IBNLINES
ISERVOPT
KSETINV
TLDSIAMA_OPTS
TRKSGRP_TYPE_C7UP

The following new Data Schema content is provided in the Carrier VoIP Operational Configuration: Data Schema Reference NTP, NN10324-509. This content will not be provided in NTP 297-8021-351.

CGBLDSIN
LOGTHROT
NTPOLL

October 2005

Standard release 10.04 for software release SN07 (DMS). Updates made in the North American Data Schema Reference Manual are shown below

Volume 2

Table BEARNETS description added for CR Q01083765.

Volume 3

Table DESDATA description added for CR Q01083765.

Volume 4

Table DPTRKMEM was created as part of activity A59015739 in an earlier release. Documentation updated for CR Q01083781.

Volume 5

Table IHEADRR description added for CR Q01083765.

Volume 8

Table NET2NET description added for CR Q01083765

Table NETBRDGE description added for CR Q01083765

Table NETPATH description added for CR Q01083765

Volume 9

Table PCEMENTT was created as part of activity A00007196 in an earlier release.
Documentation updated for CR Q01077110.

Table PCEMFEID was created as part of activity A00007196 in an earlier release.
Documentation updated for CR Q01077137.

Table PRSUDATA description added for CR Q01083765.

Table PVDNCHAN description modified for CR Q00806759/Q01207784

Volume 10

Table SELDEFS and table SETDEFS descriptions added for CR Q01083765.

December 2004

Standard release 10.03 for software release SN07 (DMS). Updates made in the North America Data Schema Reference Manual are shown below

Volume 9

Table PECINV amended for CR Q00900178

Standard release 10.02 for software release SN07 (DMS). Updates made in the North America Data Schema Reference Manual are shown below

Volume 1

AINPRESC (new), ACDENLOG, ACDGRP, ACDLOGIN, ANNS

Volume 2

No changes

Volume 3

CMIPADDR, CUSTSTN option AINDENY

Volume 4

No changes

Volume 5

IBNFEAT feature ACD, IBNFEAT feature SUPR

Volume 6

IPAPPL (new), KSETFEAT feature SUPR, KSETFEAT feature IPCLIENT, KSETLINE feature ACD

Volume 7

No changes

Volume 8

MULTITM (new), OAFUNDEF, OANODINV

Volume 9

PADDDATA, QMSMIS

Volume 10

No changes

Volume 11

TOPSFTR, TOPTDROP, TRIGINFO, TRIGITM, TRKAIN

Volume 12

No changes

September 2004

Preliminary release 10.01 for software release SN07 (DMS). Updates made in the North America Data Schema Reference Manual are shown below

Volume 1

ACDENLOG, ACDGRP, ACDLOGIN

Volume 2

AUTHCDE

Volume 3

CUSTN, CUSTN option VOWDN (new)

Volume 4

DIRPOOL2 (new), DIRPPool, DNROUTE, DNROUTE feature VOWDN (new)

Volume 5

IBNFEAT feature ECM, IBNXLA

Volume 6

ISUPTRK, KSETFEAT feature ECM

Volume 7

LIUINV, LTCINV, MNHSCARR, MSCIDMAP (new), MSCINMAP (new)

Volume 8

MUMRTAB

Volume 9

RESFEAT

Volume 10

TDBDAOPT, TMTMAP

Volume 11

TOLLTRKS, TOPSFTR, TOPSPARM, TOPSTLDN

Volume 12

TRKOPTS, VOWINV (new), XLABILL (new), XLACCLASS (new)

March 2004

Standard release 09.03 for software release SN06 (DMS). Updates made in the North America Data Schema Reference Manual are shown below.

Volume 1

DCA references changed / made obsolete

Volume 2

CARRMTC, C7UPTMR

Volume 3

DCA references changed / made obsolete

Volume 4

DNROUTE, DNROUTE feature DISA

Volume 5-6

No changes

Volume 7

LNPOPTS, LTDATA

Volume 8

OPTOPT

Volume 9

PADDATA, RDTINV

Volume 10

SUSHELF, SYNCLK, DCA references changed / made obsolete

Volume 11-12

No changes

September 2003

Standard release 09.02 for software release SN06 (DMS). Updates made in the North America Data Schema Reference Manual are shown below.

Volume 1

No changes

Volume 2

BCCODES

Volume 3

CSEDPMAP

Volume 4

DSLIMIT, FNPACONT.RTEREF

Volume 5

HNPACONT.RTEREF, IBNFEAT feature MWT, IBNLINES option MDN, IBNLINES option STN, IBNRTE selector CND, IBNRTE selector NOT, IBNXLA, IBNXLA selector FTR type LSPKP

Volume 6

ISDNPARM, ISERVOPT, KSETLINE

Volume 7

LENLINES, LTCINV, MNMGPIP

Volume 8

OFRT selector CND, OFRT selector NOT

Volume 9

No changes

Volume 10

STDPRTCT.STDPRT selector E911

Volume 11

TODHEAD, TONES, TRKGRP E911, TRKGRP type IT

Volume 12

TRKOPTS, VFGDATA, VIRGRPS

June 2003

Preliminary release 09.01 for software release SN06 (DMS). Updates made in the North America Data Schema Reference Manual are shown below.

Volume 1

ACRTE, ALMSC, ALMSCGRP, ALMSD, ALDSDGRP, ANNAUDID (new), ANNMEMS, ANNPHLST (new)

Volume 2

No changes

Volume 3

CSEDPMAP (new), CUSTN option CFIND, DEFDATA

Volume 4

FNPACONT

Volume 5

HNPACONT, IBNFEAT feature CFIND, IBNLINES, IBNRTE selector CND, IBNRTE selector NOT

Volume 6

ISERVOPT, KSETLINE

Volume 7

LRGPINV (new), LTDATA, MNCKTPAK, MNIPPARM (new), MNNODE

Volume 8

OFRT selector CND, OFRT selector NOT

Volume 9

PADDDATA, REXSCHED

Volume 10

SERVSINV, SPMECAN, SPMLDVAL (new), STDPRTCT.STDPRT selector E911

Volume 11

TODHEAD, TONES, TRKGRP E911, TRKGRP type IT

Volume 12

TRKMEM, TRKOPTS, TRKSGRP, VFGDATA, VIRTGRPS

This page is intentionally blank.

297-8021-351

DMS-100 Family

North American DMS-100

Customer Data Schema Reference Manual Volume 1 of 12

Data Schema AABSFILT-ATTSCHEd

LET0015 and up Standard 05.02 May 2001

DMS-100 Family

North American DMS-100

Customer Data Schema Reference Manual Volume 1 of 12

Data Schema AABSFILT-ATTSCHEd

Publication number: 297-8021-351

Product release: LET0015 and up

Document release: Standard 05.02

Date: May 2001

Copyright © 1996-2001 Nortel Networks,
All Rights Reserved

Printed in the United States of America

NORTEL NETWORKS CONFIDENTIAL: The information contained herein is the property of Nortel Networks and is strictly confidential. Except as expressly authorized in writing by Nortel Networks, the holder shall keep all information contained herein confidential, shall disclose the information only to its employees with a need to know, and shall protect the information, in whole or in part, from disclosure and dissemination to third parties with the same degree of care it uses to protect its own confidential information, but with no less than reasonable care. Except as expressly authorized in writing by Nortel Networks, the holder is granted no rights to use the information contained herein.

Information is subject to change without notice. Nortel Networks reserves the right to make changes in design or components as progress in engineering and manufacturing may warrant. Changes or modification to the DMS-100 without the express consent of Nortel Networks may void its warranty and void the user's authority to operate the equipment.

Nortel Networks, the Nortel Networks logo, the Globemark, How the World Shares Ideas, Unified Networks, DMS, DMS-100, Helmsman, MAP, Meridian, Nortel, Northern Telecom, NT, SuperNode, and TOPS are trademarks of Nortel Networks.

Contents

Customer Data Schema Reference Manual Volume 1 of 12 Data Schema AABSFILT-ATTSCHEd

NTP Summary Contents	vii
About this document	ix
How to check the version and issue of this document	ix
References in this document	ix
What precautionary messages mean	xi
How commands, parameters, and responses are represented	xii
Input prompt (>)	xii
Commands and fixed parameters	xii
Variables	xii
Responses	xii
1 Table status	1-1
Tables added	1-1
Table deleted	1-2
2 Table completion responsibility	2-1
3 Master list of data schema tables	3-1
4 NORESTARTSWACT utility	4-1
Description	4-1
5 Common entry field LEN	5-1
LEN Field Descriptions	5-1
ALCM	5-5
DLM	5-6
ELCM	5-7
IPE	5-7
LCM	5-8
LCME	5-8
LCMI	5-9
LDT	5-9

LM 5-10
LRU 5-10
RCS 5-11
RCT 5-11
RCU 5-12
RDT of type RCU 5-12
RDT of type RFT 5-13
RDT of type GENCSC 5-13
RDT of type GENTMC 5-14
RDT of type ICB 5-14
SRU 5-15
SVR 5-15
ISDN lines 5-16

6 Data schema 6-1

How the data schema section is organized 6-1
Data schema overview 6-1
Table descriptions 6-3
Table descriptions for line equipment number (LEN) fields 6-6
Restructured tables 6-6
Cross-reference tables 6-6

AABSFILT 6-7
AABSOST 6-9
ACBTAB 6-13
ACCINDEX 6-15
ACCODE 6-17
ACCRLY 6-98
ACCSDB 6-100
ACCSERR 6-121
ACDADMIN 6-129
ACDDNDR 6-131
ACDENLOG 6-135
ACDGRP 6-142
ACDLOGIN 6-176
ACDMISPL 6-183
ACDMISSP 6-189
ACDRTE 6-191
ACDSGRP 6-199
ACDTKMEM 6-203
ACHEAD 6-207
ACLANG 6-345
ACLOGID 6-348
ACMSG 6-350
ACRTE 6-366
ACSCALL 6-390
ACTCTL 6-394
ACTGEN 6-398
ACTMFC 6-401
ACTPATCH 6-404
ACTSIG 6-406

ACTSNBEC	6-409
ACTSOPTS	6-411
ACTTRTMT	6-414
ADACCOPT	6-417
ADJNODE	6-423
AGGREINT	6-429
AINANNS	6-432
AINPRI	6-434
AIODGRP	6-438
AIODMEM	6-442
AIODTKN	6-445
AISCAT	6-447
AKEYTAB	6-450
ALARMTAB	6-454
ALMSC	6-457
ALMSCGRP	6-470
ALMSD	6-483
ALMSDGRP	6-492
ALTSCHED	6-504
AMAGRPID	6-525
AMAOPTS	6-527
AMASRVID	6-558
AMATKOPT	6-561
AMAXLAID	6-578
AMCODE	6-586
AMHEAD	6-650
AMRCAT	6-734
AMRRROUTE	6-737
ANIATTRS	6-739
ANICNCTL	6-741
ANIDATA	6-743
ANNAUDID	6-747 to 6-748
ANNMEMS	6-749 to 6-756
ANNPHLST	6-757 to 6-761ct
ANNS	6-761cu to 6-761de
APCDINV	6-762
APINV	6-766
AREACODE	6-770
ARUIBMRT	6-772
ARUMEMBR	6-774
ARURTE	6-778
ASCS	6-780
ASRTABLE	6-783
ASSVFEAT	6-787
ASSVLINK	6-789
ATMEQ	6-792
ATPIES	6-800
ATQMSMD	6-803
ATRIMOD	6-805
ATTCONS	6-825
ATTOPTNS	6-835
ATTRIB	6-843
ATTSCHEd	6-848

NTP Summary Contents

Customer Data Schema Reference Manual Volume 1 of 12

Data Schema AABSFILT-ATTSCHEM

Customer Data Schema Reference Manual Volume 2 of 12

Data Schema AUDALARM-CCVPARMS

Customer Data Schema Reference Manual Volume 3 of 12

Data Schema CDACCESS-DFINV

Customer Data Schema Reference Manual Volume 4 of 12

Data Schema DGCODE-FTRGMEMMS

Customer Data Schema Reference Manual Volume 5 of 12

Data Schema FTRGOPTS-INWTMAP

Customer Data Schema Reference Manual Volume 6 of 12

Data Schema IOC-LENFEAT feature WML

Customer Data Schema Reference Manual Volume 7 of 12

Data Schema LENLINES-MSRTAB

Customer Data Schema Reference Manual Volume 8 of 12

Data Schema MTAHORIZ-OPTOPT

Customer Data Schema Reference Manual Volume 9 of 12

Data Schema OQCQPROF-SCALLTAB

Customer Data Schema Reference Manual Volume 10 of 12

Data Schema SCCPTMR-TMZONE

Customer Data Schema Reference Manual Volume 11 of 11

Data Schema TODHEAD-TRKGRP type NU

Customer Data Schema Reference Manual Volume 12 of 12

Data Schema TRKGRP type OC-ZONEORDR

About this document

How to check the version and issue of this document

The version and issue of the document are indicated by numbers, for example, 01.01.

The first two digits indicate the version. The version number increases each time the document is updated to support a new software release. For example, the first release of a document is 01.01. In the next software release cycle, the first release of the same document is 02.01.

The second two digits indicate the issue. The issue number increases each time the document is revised but rereleased in the same software release cycle. For example, the second release of a document in the same software release cycle is 01.02.

To determine which version of this document applies to the software in your office and how documentation for your product is organized, check the release information in *Product Documentation Directory*, 297-8991-001.

References in this document

The following documents are referred to in this document:

- *Advanced Business Services Log Report Reference Manual*
- *Advanced Business Translations Guide*
- *Alarm System Description*, 297-1001-122
- *Basic Administration Procedures*
- *Basic Translations Tools Guide*, 297-1001-360
- *Circuit Switched Data Deployment Guide*, 411-2131-500
- *Commands Reference Manual*
- *Device Independent Recording Package (DIRP) Administration Guide*
- *Digital Recorded Announcement Machine DRAM and EDRAM Guide*
- *Disk Maintenance Subsystem Reference Manual*, 297-1001-526

- *DMS-100 Family Commands Reference Manual*
- *DMS-100 Provisioning Manual, 297-1001-450*
- *DMS-250 Commands Reference Manual*
- *DMS-Spectrum Peripheral Module Commands Reference Manual*
- *Extended Peripheral Module Translations Reference Manual*
- *Feature Description Manual*
- *Integrated Services Digital Network Service Orders for ISDN Terminals Reference Manual*
- *Lines Maintenance Guide*
- *Location Routing Number-Local Number Portability Service Implementation Guide*
- *Log Report Reference Manual*
- *Meridian Digital Centrex Station Message Detail Recording Reference Guide*
- *NORESTARTSWACT User Guide, 297-1001-546*
- *Office Parameters Reference Manual*
- *Operational Measurements Reference Manual*
- *Service Problem Analysis Administration Guide*
- *SERVORD Reference Manual*
- *Software Optionality Control User Manual, 297-8991-901*
- *Subscriber Carrier Module-100 Urban Maintenance Manual, 297-8241-550*
- *Switch Performance Monitoring System Application Guide*
- *Translations Guide*
- *Trunks Maintenance Guide*

As of NA0011 (LEC and LET) and EUR010 (EUR) releases, any references to the data schema section of the *Translations Guide* will be mapped to the *Customer Data Schema Reference Manual*.

The Advanced Business Services suite does not include an Advanced Maintenance Guide. Consult one or more of the following documents:

- *Bellcore Format Automatic Message Accounting Maintenance Guide, 297-1001-570*
- *Input/Output Devices Maintenance Guide, 297-1001-590*
- *Lines Maintenance Guide, 297-1001-594*

- *Networks Maintenance Guide, 297-1001-591*
- *Peripheral Modules Maintenance Guide, 297-1001-592*
- *Trunks Maintenance Guide, 297-1001-595*

What precautionary messages mean

The types of precautionary messages used in NT documents include attention boxes and danger, warning, and caution messages.

An attention box identifies information that is necessary for the proper performance of a procedure or task or the correct interpretation of information or data. Danger, warning, and caution messages indicate possible risks.

Examples of the precautionary messages follow.

ATTENTION - Information needed to perform a task

ATTENTION

If the unused DS-3 ports are not deprovisioned before a DS-1/VT Mapper is installed, the DS-1 traffic will not be carried through the DS-1/VT Mapper, even though the DS-1/VT Mapper is properly provisioned.

DANGER - Possibility of personal injury



DANGER

Risk of electrocution

Do not open the front panel of the inverter unless fuses F1, F2, and F3 have been removed. The inverter contains high-voltage lines. Until the fuses are removed, the high-voltage lines are active, and you risk being electrocuted.

WARNING - Possibility of equipment damage



WARNING

Damage to the backplane connector pins

Align the card before seating it, to avoid bending the backplane connector pins. Use light thumb pressure to align the card with the connectors. Next, use the levers on the card to seat the card into the connectors.

CAUTION - Possibility of service interruption or degradation

**CAUTION****Possible loss of service**

Before continuing, confirm that you are removing the card from the inactive unit of the peripheral module. Subscriber service will be lost if you remove a card from the active unit.

How commands, parameters, and responses are represented

Commands, parameters, and responses in this document conform to the following conventions.

Input prompt (>)

An input prompt (>) indicates that the information that follows is a command:

```
>BSY
```

Commands and fixed parameters

Commands and fixed parameters that are entered at a MAP terminal are shown in uppercase letters:

```
>BSY CTRL
```

Variables

Variables are shown in lowercase letters:

```
>BSY CTRL ctrl_no
```

The letters or numbers that the variable represents must be entered. Each variable is explained in a list that follows the command string.

Responses

Responses correspond to the MAP display and are shown in a different type:

```
FP 3 Busy CTRL 0: Command request has been submitted.
```

```
FP 3 Busy CTRL 0: Command passed.
```

1 Table status

The user-accessible tables that are new or deleted for this release are identified.

Tables added

The following new tables were added in release CCM012:

Table 1-1

CICGRP	Carrier Identification Code Group
CFIBDATA	Call Forward/Interface Busy Data
CT4QSLRN	Call Type for Queuing Special Location Routing Number
DNDMSB	Do Not Disturb Make Set Busy
EAREGN	Equal Access Region
EASCRN	EASCRN
IPCOMID	Internet Protocol Communications Identifier
IPSVCS	Internet Protocol Service
OCIPDL	Operator Centralization Internet Protocol Data Link
OPRINFO	Operator Information
OSNCCAP	Operator Services Network Capability
TQSRNDIG	TOPS QMS Special Location Routing Number Digilator
TQSRNNAM	TOPS QMS Special Location Routing Number Name
WSALEOPT	Wholesaling Option
XLACIC	Translations Carrier Identification Code
XLAEAREG	Translations Equal Access Region
XPMIPGWY	Extended Peripheral Module Internet Protocol Gateway
XPMIPMAP	Extended Peripheral Module Internet Protocol Map

1-2 Table status

The following new tables were added in release LWW0006:

Table 1-2

CELLCUST	Cellular Customer
CMVMWI	Common Voice Mailbox Message Waiting Indicator
MOBCENT	Mobile Centrex Provisioning
SERVCHNG	Service Exchange

Table deleted

The following tables were deleted in release CCM012:

Table 1-3

BPQUEUE	TOPS Basic Services Position Queue
CLASSDEF	TOPS Call Type
CLASSNAM	TOPS Call Class
OGTMPKEY	Outgoing Trunk Multipurpose Key
OGTSPKEY	TOPS Outgoing Trunk Single-purpose Key
OIASTART	Open Information Access Automatic Session Start
QT0-QT5	TOPS Queue Length Threshold
QTTIDX	TOPS Queue Length Threshold Table Index
TEAMACD	TOPS Automatic Call Distribution
TOPSQAGE	TOPS Queue Aging
XFROPSEL	Transfer Operator Selection

2 Table completion responsibility

The table in this chapter identifies administrative responsibilities for datafilling the data schema tables. The information presented in the columns is explained as follows.

- Responsibility

In this column, the entry OPCO means that the operating company is responsible for completing the datafill. The entry NT means that Nortel is responsible for the input. The entry JOINT means that completion of the datafill is a joint responsibility between the operating company and NT.

- Mandatory

In this column, the entry MAN means that the table is mandatory to the successful running of the switch. If the entry is OPT, the table is optional. Optional tables are tables that may not be required, depending on the packages ordered by the operating company and whether the feature that uses them is required.

- Initial input

In this column, the entry YES means that initial input data is required by NT. The entry NO means that initial input data is not required by NT. The entry FIN means that initial input data is required for tables that define final lines in the system.

Table 2-1 (Sheet 1 of 41)

Table name	Responsibility	Man/Opt	Initial input
ACBTAB	OPCO	MAN	YES
ACCINDEX	OPCO	OPT	YES
ACCODE	OPCO	OPT	YES
ACCRLY	OPCO	MAN	YES
ACCSERR	OPCO	OPT	NO
ACDADMIN	NT	OPT	NO
ACDENLOG	OPCO	OPT	NO
ACDGRP	OPCO	OPT	YES
ACDLOGIN	OPCO	OPT	NO
ACDMISPL	OPCO	OPT	NO

2-2 Table completion responsibility

Table 2-1 (Sheet 2 of 41)

Table name	Responsibility	Man/Opt	Initial input
ACDMISSP	OPCO	OPT	NO
ACDRTE	JOINT	OPT	NO
ACDSGRP	OPCO	OPT	YES
ACDTKMEM	JOINT	OPT	NO
ACHEAD	OPCO	OPT	YES
ACLANG	JOINT	OPT	YES
ACLOGID	OPCO	OPT	NO
ACMSG	JOINT	OPT	YES
ACRTE	OPCO	OPT	YES
ACSCALL	OPCO	OPT	NO
ACTCTL	OPCO	OPT	NO
ACTGEN	NT	OPT	YES
ACTMFC	NT	OPT	YES
ACTSIG	OPCO	OPT	NO
ACTTRTMT	OPCO	OPT	NO
ADJNODE	OPCO	OPT	NO
AGGREINT	OPCO	OPT	NO
AINANNS	OPCO	OPT	NO
AIODGRP	OPCO	OPT	YES
AIODMEM	OPCO	OPT	YES
AIODTKN	JOINT	OPT	NO
ALARMTAB	NT	MAN	YES
ALMSC	NT	MAN	YES
ALMSCGRP	NT	MAN	YES
ALMSD	NT	MAN	YES
ALMSDGRP	NT	MAN	YES

Table 2-1 (Sheet 3 of 41)

Table name	Responsibility	Man/Opt	Initial input
ALTSCHED	OPCO	OPT	NO
AMAGRPID	OPCO	MAN	YES
AMAOPTS	OPCO	OPT	YES
AMATKOPT	OPCO	MAN	YES
AMAXLAID	OPCO	MAN	YES
AMCODE	OPCO	OPT	YES
AMHEAD	OPCO	OPT	YES
AMRCAT	OPCO	OPT	YES
AMRRROUTE	OPCO	OPT	YES
AMRTE	OPCO	OPT	YES
ANIATTRS	OPCO	OPT	NO
ANIDATA	JOINT	OPT	NO
ANNMEMS	OPCO	MAN	YES
ANNS	OPCO	MAN	YES
APCDINV	JOINT	MAN	YES
APINV	JOINT	MAN	YES
AREACODE	OPCO	MAN	YES
AREANAME	OPCO	OPT	NO
ASCS	OPCO	OPT	YES
ASRTABLE	JOINT	OPT	NO
ATMEQ	OPCO	MAN	YES
ATPIES	OPCO	OPT	NO
ATTCONS	OPCO	OPT	YES
ATTOPTNS	OPCO	OPT	NO
ATTSCHE	OPCO	OPT	NO
AUDALARM	JOINT	OPT	NO

2-4 Table completion responsibility

Table 2-1 (Sheet 4 of 41)

Table name	Responsibility	Man/Opt	Initial input
AUDIO	OPCO	OPT	FIN
AUDPRGM	OPCO	OPT	NO
AUTHCDE	OPCO	OPT	YES
AUTHGRP	OPCO	OPT	YES
AUTHPART	OPCO	OPT	YES
AUTHSGRP	OPCO	OPT	NO
AUTOEXEC	OPCO	OPT	NO
AUTOHIB	OPCO	OPT	NO
AUTOTAB	OPCO	OPT	NO
BANASYM	OPCO	OPT	NO
BANDSETS	OPCO	MAN	YES
BCCODES	OPCO	OPT	YES
BCCOMPAT	NT	MAN	NO
BCDEF	NT	MAN	NO
BCLIDGRP	OPCO	OPT	FIN
BCLIDLNK	OPCO	OPT	FIN
BGDATA	OPCO	OPT	NO
BGIDCUST	OPCO	OPT	YES
BGLOCN	OPCO	OPT	NO
BILLCODE	OPCO	OPT	YES
BITGPER	OPCO	OPT	NO
BLMTHRSH	OPCO	OPT	NO
BNMCUST	OPCO	OPT	YES
BNSINFO	OPCO	OPT	NO
BNSPARMS	OPCO	OPT	NO
BRCDATA	OPCO	OPT	NO

Table 2-1 (Sheet 5 of 41)

Table name	Responsibility	Man/Opt	Initial input
BROADCST	OPCO	OPT	NO
C6LAYER	OPCO	OPT	YES
C6LKSET	OPCO	OPT	YES
C6TRKMEM	OPCO	OPT	YES
C7AFTPC	OPCO	OPT	NO
C7ALIAS	OPCO	OPT	NO
C7ALWDPC	OPCO	OPT	NO
C7ALWGTT	OPCO	OPT	NO
C7ALWOPC	OPCO	OPT	NO
C7ALWSIO	OPCO	OPT	NO
C7BLKDPC	OPCO	OPT	NO
C7BLKOPC	OPCO	OPT	NO
C7BLKSIO	OPCO	OPT	NO
C7CDPA	OPCO	OPT	NO
C7CGPA	OPCO	OPT	NO
C7CNGSTN	OPCO	OPT	NO
C7DCIS6	OPCO	OPT	NO
C7DPCTAB	OPCO	OPT	NO
C7DSTFLD	OPCO	OPT	NO
C7GATEPC	OPCO	OPT	NO
C7GATERS	OPCO	OPT	NO
C7GTINT	OPCO	OPT	NO
C7GTNAT	OPCO	OPT	NO
C7GTT	OPCO	OPT	NO
C7GTTYPE	OPCO	OPT	NO
C7GTWLKS	OPCO	OPT	NO

2-6 Table completion responsibility

Table 2-1 (Sheet 6 of 41)

Table name	Responsibility	Man/Opt	Initial input
C7ICCVCD	OPCO	OPT	NO
C7ICCVCG	OPCO	OPT	NO
C7LINK	OPCO	OPT	NO
C7LKSET	OPCO	OPT	NO
C7LOCSSN	OPCO	OPT	NO
C7NETSSN	OPCO	OPT	NO
C7NETWRK	OPCO	OPT	NO
C7OPCTAB	OPCO	OPT	NO
C7PECRCD	OPCO	OPT	NO
C7PECRCG	OPCO	OPT	NO
C7ROUTER	JOINT	OPT	NO
C7RPLSSN	OPCO	OPT	NO
C7RSSCRN	OPCO	OPT	NO
C7RTESET	OPCO	OPT	NO
C7TIMER	OPCO	OPT	NO
C7TRKMEM	OPCO	OPT	NO
C7UPTMR	OPCO	MAN	NO
CALLCHR	OPCO	OPT	YES
CAMACSW	OPCO	OPT	YES
CAMACSWs	OPCO	OPT	YES
CAPS	OPCO	OPT	NO
CARRMTC	NT	MAN	YES
CATCLASS	OPCO	OPT	NO
CATCODES	OPCO	OPT	YES
CC2GROUP	OPCO	OPT	NO
CCANFMT	OPCO	OPT	NO

Table 2-1 (Sheet 7 of 41)

Table name	Responsibility	Man/Opt	Initial input
CCC	NT	MAN	YES
CCCSOPTS	OPCO	OPT	NO
CCDGTAN	OPCO	OPT	NO
CCGROUPS	OPCO	OPT	NO
CCIN	OPCO	OPT	YES
CCLIST	OPCO	MAN	YES
CCNAMES	OPCO	MAN	YES
CCS7PPLN	OPCO	OPT	NO
CCSALARM	OPCO	OPT	NO
CCSDOC	OPCO	OPT	YES
CCGRPING	OPCO	OPT	NO
CCTR	OPCO	OPT	YES
CCTRNSL	OPCO	MAN	YES
CCVINFO	OPCO	OPT	NO
CCVPARMS	OPCO	OPT	NO
CDACCESS	OPCO	OPT	YES
CDCUGS	OPCO	OPT	FIN
CDCDNAS	OPCO	OPT	FIN
CDCDNS	OPCO	OPT	FIN
CDCLENS	OPCO	OPT	NO
CDCLOGON	OPCO	OPT	FIN
CDCOPTS	OPCO	OPT	FIN
CDCPHPAR	OPCO	OPT	FIN
CDCSOPTS	OPCO	OPT	NO
CDCOPT2	OPCO	OPT	NO
CDRCLSNM	OPCO	MAN	YES

2-8 Table completion responsibility

Table 2-1 (Sheet 8 of 41)

Table name	Responsibility	Man/Opt	Initial input
CDRCOMPL	OPCO	MAN	YES
CDRENTCD	OPCO	MAN	YES
CDRSERVF	OPCO	MAN	YES
CELLCUST	OPCO	OPT	NO
CELLULAR	NT	OPT	NO
CFTANXLA	OPCO	OPT	NO
CFW	OPCO	OPT	NO
CFXCMD	OPCO	OPT	NO
CGNSCRN	OPCO	OPT	NO
CHARGTAB	OPCO	OPT	YES
CHGAREA	OPCO	OPT	NO
CHGRATE	OPCO	OPT	NO
CICGRP	OPCO	OPT	NO
CICSIZE4	OPCO	OPT	NO
CISCATAP	OPCO	OPT	YES
CITYWIDE	OPCO	OPT	YES
CKTDIGIT	JOINT	OPT	YES
CLGATTR	OPCO	OPT	NO
CLIDN	OPCO	OPT	NO
CLLI	OPCO	MAN	YES
CLLIMTCE	OPCO	MAN	YES
CLLIMTCE.DIAGDATA	OPCO	MAN	YES
CLSVSCRC	OPCO	OPT	YES
CLSVSCRC.CLSVSCR	OPCO	OPT	YES
CMDS	NT	OPT	YES
CMGRING	OPCO	OPT	NO

Table 2-1 (Sheet 9 of 41)

Table name	Responsibility	Man/Opt	Initial input
CMSHELF	NT	OPT	NO
CMVMWI	OPCO	OPT	NO
CNALDSPK	OPCO	MAN	YES
CNGROUP	OPCO	OPT	NO
CODEBLK	OPCO	OPT	YES
CODECALL	OPCO	OPT	YES
CONF3PR	OPCO	OPT	YES
CONF6PR	NT	OPT	YES
COSDATA	OPCO	OPT	YES
COSMAP	OPCO	OPT	YES
CPOS	OPCO	OPT	YES
CPOSTIME	OPCO	OPT	YES
CRSFMT	OPCO	OPT	YES
CRSMAP	OPCO	OPT	YES
CSDDSCUG	OPCO	OPT	YES
CT4QBLST	OPCO	OPT	NO
CT4QCALT	OPCO	OPT	NO
CT4QSLRN	OPCO	OPT	NO
CT4QSPID	OPCO	OPT	NO
CTCODE	OPCO	OPT	YES
CTHEAD	OPCO	OPT	YES
CTRLTMRS	OPCO	OPT	YES
CTRTE	OPCO	OPT	YES
CUGINFO	JOINT	OPT	NO
CUSTAB	OPCO	OPT	YES
CUSTACD	OPCO	OPT	NO

Table 2-1 (Sheet 10 of 41)

Table name	Responsibility	Man/Opt	Initial input
CUSTANN	OPCO	OPT	YES
CUSTANNS	OPCO	OPT	NO
CUSTCONS	OPCO	OPT	YES
CUSTENG	OPCO	OPT	YES
CUSTFAM	OPCO	OPT	YES
CUSTHEAD	OPCO	OPT	YES
CUSTNAME	NT	OPT	YES
CUSTNTWK	OPCO	OPT	YES
CUSTPROT	OPCO	OPT	YES
CUSTSMR	OPCO	OPT	YES
CUSTSTN	OPCO	OPT	YES
CUSTVCDR	OPCO	OPT	NO
CUSTXTRA	OPCO	OPT	YES
CXGRP	OPCO	OPT	YES
D3MAINTD	OPCO	MAN	YES
DANIID	OPCO	OPT	FIN
DART	OPCO	OPT	YES
DATAOWNR	OPCO	OPT	YES
DATASIZE	OPCO	OPT	YES
DAYOFWK	OPCO	OPT	NO
DAYOWEEK	OPCO	OPT	YES
DAYOYEAR	OPCO	OPT	YES
DAYTYPES	OPCO	OPT	YES
DCACCTL	OPCO	MAN	YES
DCACNM	OPCO	MAN	YES
DCDINFO	OPCO	MAN	YES

Table 2-1 (Sheet 11 of 41)

Table name	Responsibility	Man/Opt	Initial input
DCHINV	NT	OPT	NO
DCMEINV	JOINT	MAN	YES
DCMEMTC	OPCO	MAN	YES
DCMINV	NT	MAN	YES
DCRNETID	OPCO	OPT	YES
DCROPT	OPCO	OPT	YES
DCTDIAL	OPCO	OPT	NO
DCTS	OPCO	OPT	NO
DDU	NT	MAN	YES
DEFDATA	OPCO	OPT	NO
DESTCTL	OPCO	MAN	YES
DESTKEY	OPCO	OPT	YES
DESTNM	OPCO	MAN	YES
DESTNODE	OPCO	OPT	YES
DFINV	NT	MAN	YES
DGCODE	OPCO	OPT	YES
DGHEAD	OPCO	OPT	YES
DIALBACK	OPCO	OPT	NO
DIALPLAN	JOINT	OPT	NO
DIGCOL	OPCO	OPT	YES
DIGMAN	OPCO	OPT	YES
DIRPHOLD	OPCO	MAN	NO
DIRPPOOL	OPCO	MAN	NO
DIRPSSYS	OPCO	MAN	NO
DIUAM	JOINT	OPT	NO
DIUCONN	JOINT	OPT	NO

2-12 Table completion responsibility

Table 2-1 (Sheet 12 of 41)

Table name	Responsibility	Man/Opt	Initial input
DLCDEV	NT	MAN	YES
DLMINV	NT	OPT	YES
DMCTLIST	OPCO	OPT	NO
DMODEM	OPCO	OPT	YES
DNATTRS	OPCO	OPT	NO
DNBKSUR	OPCO	OPT	YES
DNCHNL	OPCO	OPT	YES
DNCODE	OPCO	OPT	YES
DNCTINFO	OPCO	OPT	YES
DNDMSB	OPCO	OPT	NO
DNDSCHEM	OPCO	OPT	YES
DNFEAT	OPCO	OPT	FIN
DNGRPS	OPCO	OPT	NO
DNHEAD	OPCO	OPT	YES
DNIBERT	OPCO	OPT	NO
DNINV	OPCO	MAN	YES
DNOWN	OPCO	OPT	NO
DNREGION	OPCO	OPT	YES
DNREVXLA	OPCO	OPT	YES
DNROUTE	OPCO	OPT	YES
DN RTE	OPCO	OPT	YES
DN RTEID	OPCO	OPT	NO
DNSCRN	OPCO	OPT	YES
DPACDEV	NT	MAN	YES
DPCTSCRN	OPCO	OPT	NO
DPNSSLK	NT	OPT	NO

Table 2-1 (Sheet 13 of 41)

Table name	Responsibility	Man/Opt	Initial input
DPP	OPCO	MAN	YES
DPROFILE	OPCO	OPT	FIN
DRAMS	OPCO	OPT	YES
DRAMTRK	OPCO	OPT	YES
DRMAPPL	JOINT	OPT	NO
DRMPOOL	NT	OPT	NO
DRMTRANS	OPCO	OPT	NO
DRMUSERS	OPCO	OPT	YES
DS	OPCO	OPT	YES
DSLIMIT	NT	MAN	NO
DTUPRO	NT	MAN	NO
DVIINV	NT	OPT	NO
DVSINV	NT	OPT	NO
E911ALI	JOINT	OPT	YES
E911ESN	OPCO	MAN	NO
E911NPD	OPCO	MAN	NO
E911OFC	OPCO	OPT	NO
E911PSAP	OPCO	MAN	NO
E911RCER	OPCO	OPT	NO
E911SRDB	OPCO	MAN	NO
EADNMPK	JOINT	OPT	NO
EADNMTG	JOINT	OPT	NO
EADNMTGP	JOINT	OPT	NO
EAREGN	OPCO	OPT	NO
EASAC	OPCO	MAN	YES
EASCRN	OPCO	OPT	NO

Table 2-1 (Sheet 14 of 41)

Table name	Responsibility	Man/Opt	Initial input
ECHCONF	OPCO	OPT	YES
ECHINV	OPCO	OPT	YES
ECHOSUP	OPCO	OPT	YES
EDRAMINV	OPCO	OPT	YES
ENCDINV	OPCO	OPT	NO
ENINV	OPCO	OPT	NO
ENSITES	OPCO	OPT	NO
ENTYPES	OPCO	OPT	NO
EOCDB	NT	OPT	NO
ESA	OPCO	OPT	YES
ESAHNPA	OPCO	OPT	YES
ESAPXLA	OPCO	OPT	NO
ESARTE	OPCO	OPT	YES
ESRVATTR	OPCO	OPT	NO
ESRVCAP	OPCO	OPT	NO
EXNDINV	OPCO	OPT	NO
FACODE	OPCO	OPT	YES
FAHEAD	OPCO	OPT	YES
FAILMSG	OPCO	OPT	YES
FARTE	OPCO	OPT	YES
FEATCHG	OPCO	OPT	YES
FEATDESC	JOINT	OPT	NO
FGBCIC	OPCO	OPT	NO
FIXEDANI	OPCO	OPT	NO
FLEXAMA	OPCO	MAN	YES
FMRESINV	OPCO	OPT	NO

Table 2-1 (Sheet 15 of 41)

Table name	Responsibility	Man/Opt	Initial input
FMRESUSE	OPCO	OPT	NO
FMTINV	NT	OPT	NO
FMTMAP	NT	OPT	NO
FMTSC	NT	OPT	NO
FNMAP	OPCO	OPT	YES
FNPA7DIG	OPCO	OPT	NO
FNPACONT	OPCO	OPT	YES
FNPACONT.FNPACODE	OPCO	OPT	YES
FNPACONT.FNPASTS	OPCO	OPT	YES
FNPACONT.FNPASTS.RTEREF	OPCO	OPT	YES
FNPACONT.FNPASTS.STSCODE	OPCO	OPT	YES
FNPACONT.RTEREF	OPCO	MAN	YES
FPDEVINV	JOINT	MAN	YES
FPDIPINV	JOINT	MAN	YES
FPHOPT	OPCO	OPT	NO
FRSACCCN	OPCO	OPT	NO
FRSCCTRL	OPCO	OPT	NO
FRSCIR	OPCO	OPT	NO
FRSCNEND	OPCO	OPT	NO
FRSTRKCN	OPCO	OPT	NO
FRSTRKGP	OPCO	OPT	NO
FRSTRKS	OPCO	OPT	NO
FTCODE	OPCO	OPT	YES
FTHEAD	OPCO	OPT	YES
FTRANDEV	OPCO	OPT	FIN

Table 2-1 (Sheet 16 of 41)

Table name	Responsibility	Man/Opt	Initial input
FTRGDEFS	OPCO	OPT	NO
FTRGMEMS	OPCO	OPT	NO
FTRGOPTS	OPCO	OPT	NO
FTRTE	OPCO	OPT	YES
G7MSGSET	OPCO	OPT	NO
G7PARAM	OPCO	OPT	NO
GASINFO	JOINT	OPT	NO
GCASCRN	OPCO	OPT	NO
GCASSET	OPCO	OPT	NO
GDLADEV	OPCO	MAN	YES
GPPTRNSL	OPCO	OPT	NO
GWDIGMAN	OPCO	OPT	NO
HEAPTAB	JOINT	OPT	NO
HIEINV	OPCO	OPT	YES
HNPACONT	OPCO	MAN	YES
HNPACONT.ATTRIB	JOINT	MAN	YES
HNPACONT.HNPACODE	OPCO	MAN	YES
HNPACONT.RTEMAP	OPCO	OPT	YES
HNPACONT.RTEREF	OPCO	MAN	YES
HPWASTE	JOINT	OPT	NO
HUNTGRP	OPCO	OPT	FIN
HUNTMEM	OPCO	OPT	FIN
IAACTRL	OPCO	OPT	NO
IACINV	NT	MAN	NO
IACPSINV	NT	MAN	NO
IACREQ	OPCO	OPT	NO

Table 2-1 (Sheet 17 of 41)

Table name	Responsibility	Man/Opt	Initial input
IANNINFO	OPCO	OPT	NO
IBNATD	OPCO	OPT	YES
IBNFEAT	OPCO	OPT	YES
IBNFXDS1	OPCO	OPT	NO
IBNLINES	OPCO	OPT	FIN
IBNMAP	OPCO	OPT	FIN
IBNMAP2	OPCO	OPT	FIN
IBNMAP3	OPCO	OPT	FIN
IBNMAP4	OPCO	OPT	FIN
IBNRT2	OPCO	OPT	YES
IBNRT3	OPCO	OPT	YES
IBNRT4	OPCO	OPT	YES
IBNRTE	OPCO	OPT	YES
IBNSC	JOINT	OPT	NO
IBNTREAT	OPCO	OPT	YES
IBNXLA	OPCO	OPT	YES
ICIDATA	OPCO	OPT	YES
IDIGCTL	OPCO	MAN	YES
IFC	OPCO	OPT	NO
ILPELGBL	OPCO	OPT	NO
ILPREGN	OPCO	OPT	NO
IMAGEDEV	OPCO	OPT	NO
IMGSCHEM	JOINT	OPT	NO
INATLPRT	OPCO	MAN	YES
INPRTRNS	OPCO	MAN	YES
INTCCMTR	OPCO	OPT	YES

Table 2-1 (Sheet 18 of 41)

Table name	Responsibility	Man/Opt	Initial input
INWOMAP	OPCO	OPT	YES
INWORIBN	OPCO	OPT	YES
INWORICN	OPCO	OPT	YES
INWORIRT	OPCO	OPT	YES
INWSNPA	OPCO	OPT	YES
INWTERCN	OPCO	OPT	YES
INWTERTE	OPCO	OPT	YES
INWTMAP	OPCO	OPT	YES
IOC	NT	MAN	YES
IPCOMID	OPCO	OPT	NO
IPEINV	JOINT	OPT	NO
IPHOST	OPCO	MAN	YES
IPINV	OPCO	OPT	NO
IPMLINV	NT	OPT	YES
IPNETWRK	NT	OPT	YES
IPROUTER	OPCO	OPT	FIN
IPSVCS	OPCO	OPT	NO
IPTHRON	JOINT	MAN	YES
IRLNKINV	OPCO	MAN	NO
ISAXLA	OPCO	OPT	NO
ISCTAB	OPCO	OPT	NO
ISDNBILL	OPCO	OPT	NO
ISDNPARM	OPCO	OPT	NO
ISDNPROT	OPCO	OPT	NO
ISDNTCP	OPCO	OPT	FIN
ISGDEF	OPCO	OPT	YES

Table 2-1 (Sheet 19 of 41)

Table name	Responsibility	Man/Opt	Initial input
ISGTDM	OPCO	OPT	YES
ISTRKGRP	OPCO	OPT	YES
ISUPDEST	OPCO	OPT	NO
ISUPSERV	OPCO	MAN	YES
ISUPTRK	OPCO	OPT	YES
ITOPSANI	OPCO	OPT	YES
IVDINV	OPCO	OPT	FIN
IVDTRBL	JOINT	OPT	YES
IVPNCONV	OPCO	OPT	NO
KP2TRUNK	OPCO	OPT	YES
KSETFEAT	OPCO	OPT	FIN
KSETINV	OPCO	OPT	FIN
KSETKEYS	OPCO	OPT	NO
KSETLINE	OPCO	OPT	FIN
KSETQCK	JOINT	OPT	YES
KTGROUP	OPCO	OPT	NO
KTMINMAX	OPCO	OPT	NO
KTPARMS	OPCO	OPT	NO
L2ABNLOG	OPCO	OPT	NO
L3ABNLOG	OPCO	OPT	NO
LAC	OPCO	OPT	YES
LAMABC	OPCO	OPT	YES
LATANAME	OPCO	OPT	YES
LATAXLA	OPCO	OPT	YES
LCA6SCRN	OPCO	OPT	NO
LCAINFO	OPCO	OPT	NO

Table 2-1 (Sheet 20 of 41)

Table name	Responsibility	Man/Opt	Initial input
LCARNAME	OPCO	OPT	NO
LCARSCRN	OPCO	OPT	NO
LCASCRCN	OPCO	OPT	YES
LCASCRCN.LCASCRCN	OPCO	OPT	YES
LCCOPT	JOINT	OPT	NO
LCMDRINV	NT	OPT	YES
LDMINV	NT	OPT	YES
LDTINV	OPCO	MAN	NO
LENFEAT	OPCO	MAN	FIN
LENLINES	OPCO	MAN	FIN
LGINCTRL	JOINT	OPT	YES
LIMCDINV	OPCO	MAN	YES
LIMINV	OPCO	MAN	YES
LIMPTINV	OPCO	MAN	YES
LINEATTR	OPCO	MAN	YES
LIUINV	OPCO	MAN	YES
LKIDTAB	NT	OPT	NO
LMINV	NT	OPT	YES
LMOVCODE	OPCO	OPT	YES
LMRNG	OPCO	OPT	YES
LNINV	NT	MAN	FIN
LNINVEXT	OPCO	OPT	NO
LNMPEOC	OPCO	OPT	NO
LNMTRNAM	OPCO	OPT	YES
LNSIGSYS	OPCO	OPT	YES
LNSMTCE	OPCO	OPT	NO

Table 2-1 (Sheet 21 of 41)

Table name	Responsibility	Man/Opt	Initial input
LNTHRSH	OPCO	OPT	NO
LOGCLASS	OPCO	MAN	YES
LOGDEV	OPCO	MAN	YES
LPBKMEN	NT	MAN	NO
LSCFLAGS	OPCO	OPT	YES
LSPINFO	OPCO	OPT	YES
LTCALLS	JOINT	MAN	NO
LTCINV	NT	OPT	YES
LTCPSINV	NT	OPT	YES
LTCRINV	JOINT	MAN	YES
LTCRPINV	NT	OPT	YES
LTDATA	JOINT	OPT	NO
LTDEF	NT	MAN	NO
LTDSO	OPCO	OPT	NO
LTGRP	OPCO	OPT	NO
LTMAP	NT	MAN	NO
LTPAUX	OPCO	OPT	NO
LTPDEF	OPCO	OPT	NO
MDESTIDX	OPCO	OPT	YES
MDNGRP	NT	OPT	NO
MDNMEM	NT	OPT	NO
MDSOPT	OPCO	OPT	YES
MFCACT	NT	OPT	YES
MFCPROT	NT	OPT	YES
MFCTRMT	OPCO	MAN	YES
MLCCOPT	JOINT	OPT	NO

Table 2-1 (Sheet 22 of 41)

Table name	Responsibility	Man/Opt	Initial input
MMA0-9	OPCO	MAN	YES
MMCONF	OPCO	OPT	YES
MNETATTR	OPCO	OPT	YES
MOBCENT	OPCO	OPT	NO
MODEMPRO	NT	MAN	NO
MOPTOPT	JOINT	OPT	NO
MPBINV	OPCO	OPT	NO
MPC	JOINT	OPT	NO
MPCFASTA	OPCO	OPT	NO
MPCLINK	JOINT	OPT	NO
MPCLOGIN	OPCO	OPT	NO
MPCLSET	OPCO	OPT	NO
MPHCON	OPCO	OPT	NO
MPHGRP	OPCO	OPT	NO
MQLIMITS	OPCO	OPT	NO
MRSANAME	OPCO	OPT	YES
MSBINV	NT	OPT	YES
MSBPSINV	NT	OPT	YES
MSCDINV	JOINT	OPT	NO
MSFWLOAD	OPCO	OPT	NO
MSGRTE	OPCO	OPT	NO
MSILINV	NT	OPT	YES
MSINV	JOINT	OPT	NO
MSRCDATA	OPCO	OPT	YES
MTAHORIZ	JOINT	MAN	YES
MTAMDRVE	JOINT	MAN	YES

Table 2-1 (Sheet 23 of 41)

Table name	Responsibility	Man/Opt	Initial input
MTARFIDX	OPCO	OPT	YES
MTARFNUM	OPCO	OPT	YES
MTARIFF	OPCO	OPT	YES
MTAVERT	JOINT	MAN	YES
MTD	NT	MAN	YES
MTSIGSYS	OPCO	OPT	NO
MUMRMBI	OPCO	OPT	YES
MUMRTAB	OPCO	OPT	YES
MWDATA	OPCO	MAN	YES
N7CLLDGT	OPCO	OPT	NO
N7CLLGGT	OPCO	OPT	NO
NACDGRP	JOINT	OPT	NO
NARDATA	OPCO	OPT	NO
NATDGTAN	OPCO	OPT	NO
NCOS	OPCO	OPT	YES
NCSADDR	JOINT	OPT	NO
NCSAPPL	JOINT	OPT	NO
NETATTR	OPCO	OPT	YES
NETJUNCT	NT	MAN	YES
NETNAMES	OPCO	OPT	NO
NETTOPRT	OPCO	OPT	NO
NETTOSTS	JOINT	OPT	NO
NETWORK	NT	MAN	YES
NIUINV	OPCO	MAN	YES
NLUPCLLI	OPCO	OPT	YES
NMSDATA	OPCO	OPT	YES

Table 2-1 (Sheet 24 of 41)

Table name	Responsibility	Man/Opt	Initial input
NNASST	JOINT	OPT	NO
NO6BDXLA	OPCO	MAN	YES
NO6LINKS	OPCO	MAN	YES
NO6LKSET	OPCO	MAN	YES
NO6RTSET	OPCO	MAN	YES
NO6STP	OPCO	MAN	YES
NO6STPBD	OPCO	MAN	YES
NO6TKMEM	OPCO	MAN	YES
NOPADDR	OPCO	OPT	NO
NOPAPPLN	OPCO	OPT	NO
NOPDEST	OPCO	OPT	NO
NOPUSERS	OPCO	OPT	NO
NPACAT	OPCO	OPT	YES
NPASPLIT	OPCO	OPT	NO
NPENDING	OPCO	OPT	NO
NSCANNS	OPCO	OPT	NO
NSCCARR	OPCO	OPT	YES
NSCCODE	OPCO	OPT	YES
NSCDEFS	OPCO	OPT	YES
NSCHEAD	OPCO	OPT	YES
NSCRTE	OPCO	OPT	YES
NSCSCRN	OPCO	OPT	YES
NSCSNPA	OPCO	OPT	YES
NSTAFAS	OPCO	OPT	YES
NTCLANGS	OPCO	OPT	NO
NWMAOCR	OPCO	OPT	YES

Table 2-1 (Sheet 25 of 41)

Table name	Responsibility	Man/Opt	Initial input
NWMCLLI	OPCO	OPT	YES
NWMIDOC	OPCO	OPT	YES
NWMPPLN	OPCO	OPT	YES
NWMSC	OPCO	OPT	YES
NWMSCPT	OPCO	OPT	YES
NWMSD	OPCO	OPT	YES
NWMSDPT	OPCO	OPT	YES
NX64MEM	OPCO	MAN	YES
OACAUPRF	OPCO	OPT	NO
OACNNPRF	OPCO	OPT	NO
OACTLDEF	OPCO	OPT	NO
OADSCPRF	OPCO	OPT	NO
OADTFPRF	OPCO	OPT	NO
OAFUNBLK	OPCO	OPT	NO
OAFUNDEF	OPCO	OPT	NO
OAFNDISP	OPCO	OPT	NO
OAINCTLA	OPCO	OPT	NO
OAINPARM	OPCO	OPT	NO
OAINRTE	OPCO	OPT	NO
OANODINV	OPCO	OPT	NO
OANODNAM	OPCO	OPT	NO
OATLKPRF	OPCO	OPT	NO
OATPREFIX	OPCO	OPT	NO
OASESNPL	OPCO	OPT	NO
OAVLMAP	OPCO	OPT	NO
OCCINFO	OPCO	OPT	YES

Table 2-1 (Sheet 26 of 41)

Table name	Responsibility	Man/Opt	Initial input
OCCNAME	OPCO	OPT	YES
OCCRDIG	OPCO	OPT	YES
OCCTSINT	OPCO	OPT	YES
OCDLGRP	OPCO	OPT	YES
OCIPDL	OPCO	OPT	NO
OFC	OPCO	OPT	NO
OFCCODE	OPCO	OPT	YES
OFCHEAD	OPCO	OPT	YES
OFCRTE	OPCO	OPT	YES
OFR2	OPCO	MAN	YES
OFR3	OPCO	MAN	YES
OFR4	OPCO	MAN	YES
OFRT	OPCO	MAN	YES
OFRTMA2	OPCO	OPT	YES
OFRTMA3	OPCO	OPT	YES
OFRTMA4	OPCO	OPT	YES
OFRTMAP	OPCO	OPT	YES
OHBTADMN	OPCO	OPT	NO
OHBTINV	OPCO	OPT	NO
OHIP	OPCO	OPT	YES
OHIPBULK	OPCO	OPT	YES
OLNSDARS	OPCO	OPT	NO
OLNSDFLT	OPCO	OPT	NO
OLNSEQDP	OPCO	OPT	NO
OLNSERR	OPCO	OPT	NO
OLNSLANG	OPCO	OPT	NO

Table 2-1 (Sheet 27 of 41)

Table name	Responsibility	Man/Opt	Initial input
OLNSRSDP	OPCO	OPT	NO
OLNSTARS	OPCO	OPT	NO
OMACC	NT	MAN	YES
OMACCESS	OPCO	OPT	NO
OMDEV	OPCO	OPT	NO
OMGRPORD	NT	MAN	YES
OMPRT	NT	MAN	YES
OMREPORT	OPCO	OPT	YES
OMTAPE	NT	MAN	YES
OMTHRESH	OPCO	OPT	NO
OPMINV	NT	OPT	YES
OPRINFO	OPCO	OPT	NO
OPTCTL	NT	MAN	YES
OPTOPT	JOINT	OPT	NO
OPTTREAT	OPCO	OPT	YES
OQCQPROF	OPCO	OPT	NO
OSIPARMS	OPCO	OPT	NO
OSIRROUTE	OPCO	OPT	NO
OSNCCAP	OPT	OPT	NO
OSSANNS	OPCO	OPT	NO
OSSPROV	OPCO	OPT	NO
OVNTRNSL	OPCO	MAN	YES
OVR0-9	OPCO	MAN	YES
OVRMAP	OPCO	OPT	NO
OWATZONE	OPCO	OPT	YES
OWNER	OPCO	OPT	YES

Table 2-1 (Sheet 28 of 41)

Table name	Responsibility	Man/Opt	Initial input
OWNTAB	NT	OPT	YES
PACMAN	OPCO	OPT	YES
PADDATA	OPCO	MAN	YES
PADNDEV	OPCO	OPT	NO
PATALARM	OPCO	OPT	NO
PATCHOPT	OPCO	OPT	NO
PATCTRL	OPCO	OPT	NO
PATNS	OPCO	OPT	NO
PATSET	OPCO	OPT	NO
PCIC	OPCO	OPT	NO
PFCTRL	OPCO	OPT	NO
PFXTREAT	OPCO	OPT	YES
PHDS1	JOINT	OPT	NO
PHINFO	JOINT	OPT	NO
PHINV	OPCO	OPT	NO
PILOTGRP	OPCO	OPT	NO
PINDATA	JOINT	OPT	NO
PMEXCEPT	OPCO	OPT	NO
PMLOADS	OPCO	MAN	NO
PMNODES	NT	MAN	YES
POECNM	OPCO	OPT	NO
POECSCRN	OPCO	OPT	NO
POTNUMS	OPCO	OPT	NO
POSITION	OPCO	OPT	YES
POSNAME	OPCO	OPT	YES
PRECONF	OPCO	OPT	NO

Table 2-1 (Sheet 29 of 41)

Table name	Responsibility	Man/Opt	Initial input
PREFHUNT	OPCO	OPT	FIN
PREPLANS	OPCO	OPT	YES
PRIPROF	OPCO	MAN	NO
PRTN2CCD	OPCO	OPT	YES
PRTTONET	OPCO	OPT	NO
PS	OPCO	MAN	NO
PSCNUM	JOINT	OPT	NO
PSNAILUP	OPCO	OPT	NO
PSTNTRK	OPCO	OPT	NO
PTIDTAB	NT	OPT	NO
PVCINFO	JOINT	OPT	NO
PVCTYPE	OPCO	OPT	NO
PVDNAGEN	OPCO	OPT	NO
PVDNCHAN	OPCO	OPT	NO
PVDNCUST	OPCO	OPT	NO
PVDNCUST.AGENTS	OPCO	OPT	NO
PVDNCUST.CONNECT	OPCO	OPT	NO
PXCODE	OPCO	OPT	YES
PXHEAD	OPCO	OPT	YES
PXLAMAP	OPCO	OPT	FIN
PXRTE	OPCO	OPT	YES
R2PROT	OPCO	OPT	NO
RADR	OPCO	OPT	NO
RAINV	NT	MAN	NO
RALNK	NT	MAN	NO
RASLAPPL	OPCO	OPT	YES

Table 2-1 (Sheet 30 of 41)

Table name	Responsibility	Man/Opt	Initial input
RCCINV	NT	OPT	YES
RCCPSINV	NT	OPT	YES
RCFCLI	OPCO	OPT	NO
RCNAME	OPCO	OPT	FIN
RCSINV	NT	OPT	YES
RCTALM	OPCO	OPT	YES
RCTINV	NT	OPT	YES
RCUALRMS	OPCO	OPT	NO
RCUINV	OPCO	OPT	YES
RDTINV	NT	MAN	YES
RDTLT	NT	OPT	NO
REASONS	OPCO	OPT	NO
RECEIVER	OPCO	MAN	YES
REMNACD	JOINT	OPT	NO
REMOTLAC	OPCO	OPT	YES
REPLCODE	OPCO	OPT	YES
REPLDATA	OPCO	OPT	NO
REPLNAME	OPCO	OPT	YES
REROUTE	OPCO	OPT	YES
REROUTE.NWMRRROUT	OPCO	OPT	YES
RESFEAT	OPCO	OPT	NO
RESGROUP	OPCO	OPT	FIN
RESINV	NT	OPT	FIN
RESMEM	OPCO	OPT	FIN
RESOFC	OPCO	OPT	NO
REXINTEN	OPCO	OPT	NO

Table 2-1 (Sheet 31 of 41)

Table name	Responsibility	Man/Opt	Initial input
REXSCHED	OPCO	OPT	NO
RGSIGSYS	OPCO	MAN	YES
RLOGCLAS	OPCO	OPT	NO
RLOGDEV	OPCO	OPT	NO
RLOGTAB	OPCO	OPT	NO
RMCONFIG	OPCO	OPT	NO
RMMINV	NT	OPT	YES
ROTLCB	OPCO	OPT	YES
ROTLSCSD	OPCO	OPT	YES
ROUTEMAP	JOINT	OPT	NO
RPINV	NT	MAN	NO
RPLNK	NT	MAN	NO
RSM	OPCO	OPT	YES
RTECHAR	OPCO	OPT	FIN
RTSALGO	JOINT	OPT	NO
RTSNT	JOINT	OPT	NO
SAAUTO	OPCO	OPT	NO
SACB	OPCO	OPT	YES
SACODES	OPCO	OPT	NO
SASPEC	OPCO	OPT	YES
SAUSERS	OPCO	OPT	NO
SCAICOMS	OPCO	OPT	NO
SCAIGRP	OPCO	OPT	NO
SCAILNKS	JOINT	OPT	NO
SCAIPROF	OPCO	OPT	NO
SCAISRVC	OPCO	OPT	NO

Table 2-1 (Sheet 32 of 41)

Table name	Responsibility	Man/Opt	Initial input
SCAISSRV	OPCO	OPT	NO
SCAISVID	OPCO	OPT	NO
SCALLTAB	JOINT	OPT	NO
SCGRP	NT	MAN	NO
SCPCOMP	JOINT	MAN	YES
SCPDB	JOINT	MAN	YES
SCPLOCSS	JOINT	OPT	YES
SCPSERV	JOINT	MAN	NO
SCRNAMES	OPCO	MAN	YES
SCRNCLAS	OPCO	OPT	YES
SCUFEAT	OPCO	OPT	YES
SDGRP	NT	MAN	YES
SDMBILL	JOINT	OPT	YES
SDSCUST	OPCO	OPT	NO
SDSINFO	OPCO	OPT	NO
SEASMP	JOINT	OPT	FIN
SEILINKS	JOINT	MAN	YES
SERVCHNG	OPCO	OPT	NO
SERVICE	OPCO	OPT	NO
SFWALARM	NT	MAN	YES
SHADOW	NT	MAN	NO
SIGACT	OPCO	OPT	NO
SILCNWM	OPCO	MAN	YES
SITE	OPCO	OPT	YES
SITEDIAL	OPCO	MAN	NO
SITELOC	OPCO	MAN	NO

Table 2-1 (Sheet 33 of 41)

Table name	Responsibility	Man/Opt	Initial input
SLELIST	OPCO	OPT	NO
SLLNKDEV	NT	OPT	NO
SLM	NT	OPT	NO
SLNWK	JOINT	OPT	YES
SNIXAPPL	OPCO	OPT	NO
SNIXINFO	OPCO	OPT	NO
SNIXVOLS	OPCO	OPT	NO
SNPANAME	OPCO	OPT	YES
SNVLGRP	OPCO	OPT	NO
SOFTKEY	OPCO	OPT	YES
SORLIST	OPCO	OPT	YES
SPCCON	OPCO	OPT	NO
SPCTRKS	OPCO	OPT	NO
SPECCONN	OPCO	OPT	YES
SPECIAL	OPCO	OPT	NO
SPID	OPCO	OPT	NO
SPIDDB	OPCO	OPT	NO
SPIDGRP	OPCO	OPT	NO
SRDBXFER	OPCO	OPT	NO
SRVCIND	OPCO	OPT	NO
SSPTKINF	OPCO	OPT	YES
STDPRTCT	OPCO	MAN	YES
STDPRTCT.AMAPRT	OPCO	OPT	YES
STDPRTCT.STDPRT	OPCO	MAN	YES
STIDX	OPCO	OPT	YES
STINV	NT	OPT	YES

Table 2-1 (Sheet 34 of 41)

Table name	Responsibility	Man/Opt	Initial input
STN	OPCO	MAN	YES
STPOOLS	NT	OPT	YES
STREAM	OPCO	OPT	NO
STSTONET	JOINT	OPT	NO
SUBGRP	OPCO	OPT	YES
SUBPROT	OPCO	OPT	YES
SUPERTKG	OPCO	OPT	NO
SUSHELF	OPCO	OPT	YES
SVCDATA	OPCO	MAN	NO
SVCRATE	OPCO	OPT	NO
SVPRIGRP	OPCO	OPT	NO
SVRCKT	OPCO	OPT	YES
SYLNKINV	OPCO	OPT	YES
SYNCLK	NT	OPT	YES
SYNOGLNK	OPCO	OPT	YES
SYSDATA	JOINT	MAN	NO
TASIB	OPCO	OPT	YES
TCAPTRID	OPCO	OPT	YES
TCLG7DIG	OPCO	OPT	NO
TCLGVER	OPCO	OPT	NO
TCNDATA	JOINT	OPT	NO
TDBNORM	OPCO	OPT	YES
TDBSERV	OPCO	OPT	YES
TDCHLDY	OPCO	OPT	YES
TDCSCHED	OPCO	OPT	YES
TERMDEV	NT	MAN	YES

Table 2-1 (Sheet 35 of 41)

Table name	Responsibility	Man/Opt	Initial input
TEXTLOG	OPCO	OPT	NO
TEXTPHRS	OPCO	OPT	NO
TFANINT	OPCO	OPT	YES
TIMEODAY	OPCO	OPT	YES
TIMESPEC	OPCO	OPT	YES
TKCVDATA	OPCO	OPT	NO
TKFXPT	OPCO	MAN	YES
TKMTRNAM	OPCO	OPT	YES
TKSIGSYS	OPCO	MAN	YES
TKTONODE	OPCO	OPT	YES
TMINV	NT	MAN	YES
TMSOCDL	OPCO	OPT	YES
TMTCNTL	OPCO	MAN	YES
TMTCNTL.TREAT	OPCO	MAN	YES
TMTMAP	OPCO	OPT	YES
TODCHG	OPCO	OPT	NO
TODHEAD	OPCO	OPT	YES
TOFCNAME	OPCO	MAN	YES
TOLLENTC	OPCO	OPT	YES
TOLLTRKS	OPCO	OPT	NO
TONES	OPCO	MAN	YES
TOPAUDIO	OPCO	OPT	NO
TOPCACAR	OPCO	OPT	NO
TOPCATRK	OPCO	OPT	NO
TOPLNPOP	OPCO	OPT	NO
TOPSBPC	OPCO	OPT	YES

Table 2-1 (Sheet 36 of 41)

Table name	Responsibility	Man/Opt	Initial input
TOPSDP	OPCO	OPT	NO
TOPSPFX	OPCO	OPT	YES
TOPSZONE	OPCO	OPT	NO
TOPTDROP	OPCO	OPT	NO
TQCAPROF	OPCO	OPT	NO
TQSPIDNM	OPCO	OPT	NO
TQSRNDIG	OPCO	OPT	NO
TQSRNNAM	OPCO	OPT	NO
TRBLCODE	OPCO	OPT	YES
TRIGDIG	OPCO	OPT	YES
TRIGGRP	OPCO	OPT	YES
TRIGINFO	OPCO	OPT	YES
TRKDCTS	OPCO	OPT	NO
TRKGRP	OPCO	OPT	YES
TRKGRP(A5)	OPCO	OPT	YES
TRKGRP(AI)	OPCO	OPT	YES
TRKGRP(AN)	OPCO	OPT	YES
TRKGRP(ANI)	OPCO	MAN	YES
TRKGRP(ATC)	OPCO	OPT	YES
TRKGRP(CA)	OPCO	OPT	YES
TRKGRP(CELL)	OPCO	OPT	YES
TRKGRP(CISANI)	OPCO	MAN	YES
TRKGRP(DA)	OPCO	OPT	YES
TRKGRP(DS0)	OPCO	OPT	NO
TRKGRP(E911)	OPCO	MAN	NO
TRKGRP(ES)	OPCO	OPT	YES

Table 2-1 (Sheet 37 of 41)

Table name	Responsibility	Man/Opt	Initial input
TRKGRP(GER2W)	OPCO	OPT	NO
TRKGRP(GERIC)	OPCO	OPT	NO
TRKGRP(GEROG)	OPCO	OPT	NO
TRKGRP(GW)	OPCO	OPT	YES
TRKGRP(IBNT2)	OPCO	OPT	YES
TRKGRP(IBNTI)	OPCO	OPT	YES
TRKGRP(IBNTO)	OPCO	OPT	YES
TRKGRP(IET)	OPCO	OPT	NO
TRKGRP(INT101)	OPCO	OPT	YES
TRKGRP(IR)	OPCO	OPT	YES
TRKGRP(IS)	OPCO	OPT	YES
TRKGRP(IT)	OPCO	OPT	YES
TRKGRP(ITL2)	OPCO	OPT	YES
TRKGRP(ITOPS)	OPCO	OPT	YES
TRKGRP(LOOPA)	OPCO	OPT	YES
TRKGRP(LP4W)	OPCO	OPT	YES
TRKGRP(LPBK)	NT	MAN	NO
TRKGRP(MAINT)	OPCO	OPT	YES
TRKGRP(MTR)	OPCO	OPT	YES
TRKGRP(NFA)	OPCO	OPT	YES
TRKGRP(NU)	OPCO	OPT	YES
TRKGRP(OC)	OPCO	OPT	YES
TRKGRP(OI)	OPCO	OPT	YES
TRKGRP(OP)	OPCO	OPT	YES
TRKGRP(OPR)	OPCO	OPT	YES
TRKGRP(OS)	OPCO	OPT	YES

Table 2-1 (Sheet 38 of 41)

Table name	Responsibility	Man/Opt	Initial input
TRKGRP(P2)	OPCO	OPT	YES
TRKGRP(PRA)	JOINT	OPT	NO
TRKGRP(PRIVLN)	OPCO	OPT	YES
TRKGRP(PX)	OPCO	OPT	YES
TRKGRP(RC)	OPCO	OPT	YES
TRKGRP(RONI)	OPCO	OPT	YES
TRKGRP(ROTL)	OPCO	OPT	YES
TRKGRP(SC)	OPCO	OPT	YES
TRKGRP(SOCKT)	OPCO	OPT	YES
TRKGRP(SPC)	OPCO	OPT	YES
TRKGRP(T101)	OPCO	OPT	YES
TRKGRP(T105)	OPCO	OPT	YES
TRKGRP(T2)	OPCO	OPT	YES
TRKGRP(TD)	OPCO	OPT	YES
TRKGRP(TDDO)	OPCO	OPT	YES
TRKGRP(TI)	OPCO	OPT	YES
TRKGRP(TL)	OPCO	OPT	YES
TRKGRP(TO)	OPCO	OPT	YES
TRKGRP(TOPS)	OPCO	OPT	YES
TRKGRP(TOPSARU)	OPCO	MAN	YES
TRKGRP(TOPSVL)	OPCO	OPT	YES
TRKGRP(TPS101)	OPCO	OPT	YES
TRKGRP(TTL2)	OPCO	OPT	YES
TRKGRP(VR)	OPCO	OPT	YES
TRKGRP(X75)	OPCO	OPT	NO
TRKGRP(ZI)	OPCO	OPT	YES

Table 2-1 (Sheet 39 of 41)

Table name	Responsibility	Man/Opt	Initial input
TRKLATA	OPCO	MAN	YES
TRKMEM	OPCO	MAN	YES
TRKMTCE	OPCO	OPT	NO
TRKNAME	NT	OPT	YES
TRKSGRP	OPCO	MAN	YES
TRTMTACT	OPCO	OPT	NO
TRTMTMFC	OPCO	MAN	YES
TSTAB	OPCO	OPT	NO
TSTCCT	OPCO	MAN	YES
TSTCCTIX	OPCO	MAN	YES
TSTEQUIP	NT	OPT	NO
TSTLCONT	OPCO	MAN	YES
TSTLCONT.TLNOS	OPCO	MAN	YES
TSTXCON	JOINT	OPT	NO
TTANTTPG	OPCO	MAN	YES
TTL4	OPCO	OPT	YES
TVDSTRKS	JOINT	OPT	YES
UCDGRP	OPCO	OPT	YES
V5PROV	OPCO	OPT	NO
VARACCT	OPCO	OPT	NO
VERSIONS	NT	MAN	NO
VFGDATA	NT	OPT	NO
VFGENG	NT	OPT	NO
VIPCODES	OPCO	OPT	NO
VIPDNS	OPCO	OPT	NO
VIRTGRPS	OPCO	OPT	YES

Table 2-1 (Sheet 40 of 41)

Table name	Responsibility	Man/Opt	Initial input
VMXTAB	OPCO	OPT	YES
VPNMAP	OPCO	OPT	NO
VPNXLA	OPCO	OPT	NO
VPSRVDEF	OPCO	OPT	NO
VPUSERV	OPCO	OPT	NO
VSNALARM	OPCO	OPT	FIN
VSNEXTID	JOINT	OPT	YES
WATSAUTH	OPCO	OPT	NO
WATSBAND	OPCO	MAN	YES
WCKCODES	OPCO	OPT	YES
WRDNCODE	OPCO	OPT	YES
WSALEOPT	OPCO	OPT	NO
X75INFO	JOINT	OPT	NO
XESAINV	NT	OPT	YES
XFERADDR	OPCO	OPT	NO
XFERSSYS	OPCO	OPT	NO
XLACIC	OPCO	OPT	NO
XLAEAREG	OPCO	OPT	NO
XLAGRP	OPCO	OPT	NO
XLAMAP	OPCO	OPT	FIN
XLANAME	OPCO	OPT	YES
XLAODIGS	OPCO	OPT	NO
XLASPID	OPCO	OPT	NO
XPMIPGWY	OPCO	OPT	NO
XPMIPMAP	OPCO	OPT	NO
XPMLFP	OPCO	MAN	NO

Table 2-1 (Sheet 41 of 41)

Table name	Responsibility	Man/Opt	Initial input
XSGDEF	OPCO	MAN	YES
ZONEFOR	OPCO	OPT	NO
ZONENAT	OPCO	OPT	NO
ZONEORDR	OPCO	OPT	YES

3 Master list of data schema tables

This list contains the short names and full titles of switch tables for the DMS Product Family.

Tables OFCENG, OFCOPT, OFCSTD, OFCVAR, and ISDNVAR are documented in the *Office Parameters Reference Manual*.

Table 3-1 (Sheet 1 of 87)

Short name	Title
AABSFILT	Automated Alternate Billing Service Filter Table
AABSOST	Automated Alternate Billing Service Originating Station Treatment Table
ACBTAB	All Circuits Busy Table
ACCINDEX	Accounting Route Index Table
ACCODE	Access Code Table
ACCRLY	Access Relay Table
ACCSDB	Automatic Calling Card Service Database Table
ACCSERR	Automatic Calling Card Service Errors Table
ACCTCODE	ITOPS Account Code Table
ACDADMIN	Automatic Call Distribution Administration Groups Table
ACDDNDR	Automatic Call Distribution Directory Number Route Table
ACDENLOG	Automatic Call Distribution Login Enhancement Table
ACDGRP	Automatic Call Distribution Group Table
ACDLOGIN	Automatic Call Distribution Login ID Password Table
ACDMISPL	Automatic Call Distribution MIS Pool Table

3-2 Master list of data schema tables

Table 3-1 (Sheet 2 of 87)

Short name	Title
ACDMISSP	Automatic Call Distribution MIS Subpool Table
ACDRTE	Automatic Call Distribution Routing Table
ACDSGRP	Automatic Call Distribution Subgroup Table
ACDTKMEM	Automatic Call Distribution Trunk Member Table
ACHEAD	Access Code Head Table
ACLANG	Attendant Console Display Language Table
ACLOGID	Attendant Console Login ID Table
ACMSG	Attendant Console Messages Table
ACRTE	Access Code Route Table
ACSCALL	Attendant Speed Calling Table
ACTCTL	XPM Activity Controller Table
ACTGEN	Multifrequency Compelled Activity Generator Table
ACTMFC	Multifrequency Compelled Activity to Signal Translation Table
ACTPATCH	Activateable Patches Table
ACTSIG	XPM Activity-to-Signal Mapping Table
ACTSNBEC	Automated Coin Toll Service Non-Bell Exchange Carrier Table
ACTSOPTS	Automated Coin Toll Service Optional Timeout Parameters Table
ACTTRTMT	Activity To Treatment Mapping Table
ADACCOPT	Automatic Directory Assistance Call Completion Options Table
ADJNODE	Adjacent Node Table
AGGREINT	Frame Relay Service Aggregate Billing Interval Table
AINANNS	Advanced Intelligent Network Announcement Table
AINPRI	Advanced Intelligent Network Primary Rate Interface Table
AIODGRP	Auto-Identified Outward Dialing Group Table
AIODMEM	Auto-Identified Outward Dialing Member Table
AIODTKN	Auto-Identified Outward Dialing Token Table

Table 3-1 (Sheet 3 of 87)

Short name	Title
AISCAT	Automatic Intercept Service Category Table
AKEYTAB	Access Key Table
ALARMTAB	Threshold Alarms Table
ALMSC	Alarm Scan Table
ALMSCGRP	Alarm Scan Group Table
ALMSD	Alarm Signal Distributor Point Table
ALMSDGRP	Alarm Signal Distributor Group Table
ALTSCHEM	Automatic Line Testing Schedule Table
AMAGRPID	Automatic Message Accounting Group Identification Table
AMAOPTS	Automatic Message Accounting Options Table
AMASRVID	TOPS Automatic Message Accounting Service Identification Table
AMATKOPT	Automatic Message Accounting Trunk Group Option Table
AMAXLAID	Automatic Message Accounting Translations Identification Table
AMCODE	Ambiguous Code Table
AMHEAD	Ambiguous Code Head Table
AMRCAT	AMR Category Digits Table
AMRRROUTE	AMR Route Table
AMRTE	Ambiguous Code Route Table
ANIATTRS	Automatic Number Identification Attributes Table
ANICNCTL	Automatic Number Identification Control Table
ANIDATA	Automatic Number Identification Data Table
ANNMEMS	Announcement Members Table
ANNS	Announcement Table
AOCBASIC	Advice of Charge Basic Table (MMP only)
AOCBSDSC	Advice of Charge Basic Service Discounts Table (MMP only)
AOCOPT	Advice of Charge Optimization Table (MMP only)

3-4 Master list of data schema tables

Table 3-1 (Sheet 4 of 87)

Short name	Title
APCDINV	Application Processor Card Inventory Table
APINV	Application Processor Inventory Table
AREACODE	SSP Area Code Table
AREANAME	Area Name Table
ARUIBMRT	Audio Response Unit IBM Route Table
ARUMEMBR	Audio Response Unit Member Table
ARURTE	Audio Response Unit Route Table
ASCS	Alarm Sending And Checking Table
ASRTABLE	Automatic Set Relocation Table
ASSVFEAT	Assisted Service Features Table
ASSVLINK	Assisted Service Link Table
ATMEQ	Automatic Transmission Measuring Equipment Q Table
ATPIES	ISUP Access Transport Parameter Information Element Table
ATQMSMD	Charge Calculator Attribute Queue Management System Discount and Surcharge Modification Table
ATRIMOD	ITOPS Rating Charge Calculator Attribute Discount and Surcharge Table
ATTCONS	Attendant Console Table
ATTOPTNS	Automatic Trunk Test Sequence Option Table
ATTRIB	ITOPS Rating Charge Calculator Attribute Table
ATTSCHED	Automatic Trunk Test Group Schedule Table
AUDALARM	Audible Alarm Table
AUDIO	Audio Interlude Table
AUDPRGM	Automatic Dial Key Program Table
AUTHCDE	Authorization Code Table
AUTHGRP	Authorization Group Table
AUTHPART	Authorization Partition Table

Table 3-1 (Sheet 5 of 87)

Short name	Title
AUTHSGRP	Authorization Codes Group Table
AUTOEXEC	Automatic File-Execution Table
AUTOHIB	Autopatcher Uninhibited Log Reports Table
AUTOTAB	Automated Table Audit Table
BANASYM	Ban Numbers from Asymmetric Switching Table
BANDSETS	Band Sets Table
BCCODES	Bellcore Codes Table
BCCOMPAT	Bearer Capability Compatibility Table
BCDEF	Bearer Capability Definition Table
BCLIDGRP	Bulk Calling Line Identification Group Table
BCLIDLNK	Bulk Calling Line Identification Link Table
BELLCAT	ANI ID Mapping for TOPS Trunk Groups with Bell Signaling Table
BGDATA	Business Group Data Table
BGIDCUST	Business Group to Customer Group Mapping Table
BGIDMAP	Business Group Identifiers Map Table (MMP only)
BGLOCN	Business Group Location Table
BILLCODE	Billing Code Table
BITGPER	Busy/Idle Trunk Group Period Table
BLDDATA	Build Data Table
BLMTHRSH	Basic Line Monitoring Threshold Table
BNMCUST	Business Network Management Customer Table
BNSINFO	Billed Number Screening Information Table
BNSPARMS	Billed Number Screening Parameters Table
BPQUEUE	TOPS Basic Service Position Queue
BRANDANN	Branding Announcements Table
BRANDOPT	Branding Options Table

Table 3-1 (Sheet 6 of 87)

Short name	Title
BRCDATA	Bidirectional Trunk Group Reservation Controls Table
BROADCST	Broadcast Call Table
C6LAYER	CCIS6 Layer Allocation Table
C6LKSET	CCIS6 Signaling Link Table
C6TRKMEM	CCIS6 Trunk Member Table
C7AFTPC	CCS7 Gateway STP SCCP Management Affected Point Code Screening Table
C7ALIAS	CCS7 Capability Codes Table
C7ALWDPC	CCS7 Gateway STP Allowed Destination Point Codes Screening Table
C7ALWGTT	CCS7 Gateway STP SCCP Allowed Global Title Translation Screening Table
C7ALWOPC	CCS7 Gateway STP Allowed Originating Point Codes Screening Table
C7ALWSIO	CCS7 Gateway STP Allowed Service Info Octets Screening Table
C7BLKDPC	CCS7 Gateway STP Blocked Destination Point Codes Screening Table
C7BLKOPC	CCS7 Gateway STP Blocked Originating Point Codes Screening Table
C7BLKSIO	CCS7 Gateway STP Blocked Service Info Octets Screening Table
C7CDPA	CCS7 Gateway STP SCCP Called Party Address Screening Table
C7CGPA	CCS7 Gateway STP SCCP Calling Party Address Screening Table
C7CNGSTN	CCS7 Congestion Threshold Table
C7DCIS6	CCS7 STP Global Title Translation of DCIS6 Messages Table
C7DPCTAB	CCS7 Destination Point Code Table
C7DSTFLD	CCS7 Gateway STP Destination Field Screening Table
C7GATEPC	CCS7 Gateway Point Code Table
C7GATERS	CCS7 Gateway Routeset Table

Table 3-1 (Sheet 7 of 87)

Short name	Title
C7GTINT	CCS7 Global Title International Translation Table
C7GTNAT	CCS7 Global Title National Translation Table
C7GTT	CCS7 Global Title Translation Table
C7GTTDF	CCS7 Global Title Translation Delta File Table
C7GTTYPE	CCS7 Global Title Translation Type Table
C7GTWLKS	CCS7 Gateway STP Linksets Screening Table
C7ICCVCD	International Credit Card Validation Called Party Address Table
C7ICCVCG	International Credit Card Validation Calling Party Address Table
C7ISL	C7 ISDN User Part Signaling Loopback Table
C7LINK	CCS7 Link Table
C7LKPARAM	CCS7 Link Parameter Table
C7LKSET	CCS7 Linkset Table
C7LOCSSN	CCS7 Local Subsystem Table
C7NETSSN	CCS7 Network Subsystem Routing Table
C7NETWRK	CCS7 Network Table
C7PECRCD	Pan-European Cellular Radio Called Party Address Table
C7OPCTAB	CCS7 Origination Point Code Table
C7PECRCG	Pan-European Cellular Radio Calling Party Address Table
C7ROUTER	CCS7 Router Table
C7RPLSSN	CCS7 Replicate Subsystem Table
C7RSSCRN	CCS7 Remote Subsystem Concerned Node Table
C7RTESET	CCS7 Routeset Table
C7TIMER	CCS7 Timer Table
C7TRKMEM	CCS7 Trunk Member Table
C7UPTMR	CCS7 Signaling ISUP Timers Table
C7UPTMR(AISUP)	Australian ISDN User Part Subtable

3-8 Master list of data schema tables

Table 3-1 (Sheet 8 of 87)

Short name	Title
C7UPTMR(ATUP)	Australian Telephone User Part Subtable
C7UPTMR(BTUP)	United Kingdom Variant of National User Part Subtable
C7UPTMR(CCITT250)	CCITT ISUP Subtable
C7UPTMR(IBNISUP)	Integrated Business Network 7 Subtable
C7UPTMR(JPNISUP)	Japan Public Network 7 Subtable
C7UPTMR(MBTUP)	Operating Company Specific Network Interworking Subtable
C7UPTMR(NCCI)	Operating Company Specific CCIT7 Protocols Subtable
C7UPTMR(Q764)	American National Standards Institute (ANSI) ISUP Protocol Subtable
C7UPTMR(Q767)	CCITT ISUP Protocol Subtable
C7UPTMR(TUP_BLUE)	Signaling 7 Protocols BTUP & TUPPLUS DMS-300 Internetworking Subtable
C7UPTMR(TUPPLUS)	BTUP Internetworking with TUP+ or Other Signaling 7 Protocols Subtable
CALLCHR	Call Characteristic Table
CAMACSW	CAMA Call Waiting Lamp Threshold Table
CAMACSWs	CAMA Call Waiting and Suspension Circuit Table
CAPS	Call Appearance Sequence Table
CARDBRND	Card Brand Table
CARNAME	Carrier Name Table (MMP only)
CARRMTC	Carrier Maintenance Control Table
CARRTRF	Carrier Tariff Table
CATCLASS	R2 Protocol Category Classification Table
CATCODES	AMR5 Category Code Table
CC2GROUP	Country Code to Country Code Group Table
CCANFMT	Calling Card Account Format Table
CCC	Central Control Complex Assignment Table
CCCSOPTS	Calling Card Carrier Select Options Table

Table 3-1 (Sheet 9 of 87)

Short name	Title
CCDGTAN	Country Code Digit Analyser Table
CCGROUPS	Country Code Groups Table
CCGRPING	Calling Card Grouping Table
CCIN	Central Control Inventory Table
CCLIST	Country Code List Table
CCNAMES	Country Code Translation Names Table
CCS7PPLN	CCS7 Preplan Control Table
CCSALARM	Common Channel Signaling Alarm Table
CCSDOC	CCS Selective Dynamic Overload Control Table
CCTR	Country Code Table
CCTRNSL	Country Code Translation Table
CCVINFO	Calling Card Validation Information Table
CCVPARMS	Calling Card Validation Parameters Table
CDACCESS	Country Direct Access Codes Table
CDCARR	Country Direct Carriers of Origin Table
CDCARRRT	Country Direct Carrier Rating Names Table
CDCCUGS	Customer Data Change Closed User Group Table
CDCDNAS	Customer Data Change Data Network Address Table
CDCDNS	Customer Data Change Directory Number Table
CDCLENS	Customer Data Change Line Table
CDCLOGON	Customer Data Change Logon Table
CDCOPTS	Customer Data Change Line Option Table
CDCPHPAR	Customer Data Change Packet Handler Parameter Table
CDCSOPTS	Country Direct Carrier Select Options Table
CDCSOPT2	Country Direct Carrier Select Options Number 2 Table
CDCTRY	Country Direct Country Codes Table

Table 3-1 (Sheet 10 of 87)

Short name	Title
CDCTRYNM	Country Direct Country Names Table
CDCTRYRT	Country Direct Country Rating Names Table
CDNCHAR	Called Number Parameter Characteristic Definition Table (MMP only)
CDNIXLA	Called Number Parameter Characteristic Analysis and Routing Table (MMP only)
CDNUXLA	Called Number Parameter Universal Translations Table (MMP only)
CDRATE	Country Direct Rate Table
CDRATEG	Country Direct Rate Global Table
CDRCLSNM	Call Detail Recording Class Names Table
CDRCOMPL	Call Detail Recording Completion Code Table
CDRENTCD	Call Detail Recording Entry Code Table
CDRSERVF	Call Detail Recording Service Feature Table
CELLCUST	Cellular Customer Table
CELLULAR	Cellular Subscriber Database Table
CFIBDATA	Call Forward/Interface Busy Data
CFTANXLA	Call Forward to Announcement Translations Table
CFW	Regular and Remote Call Forwarding Table
CFX	Call Forwarding (Universal/Busy/Don't Answer) Table
CFXCMD	Call Forwarding Circuit Mode Data Table
CGNSCRN	Calling Number Screening Table
CHARGE	TOPS Charge Table
CHARGEI	TOPS Charge Inactive Table
CHARGTAB	Multiunit Message Rate Charge Table
CHGADJKY	TOPS Equal Access Charge Adjust Key Table
CHGAREA	Charge Area Information Table
CHGATRIB	ITOPS Rating Charge Calculator Attribute Charge Table

Table 3-1 (Sheet 11 of 87)

Short name	Title
CHGHEAD	ITOPS Rating Charge Calculator Head Charge Table
CHGMAP	TOPS Schedule Charge Mapping Table
CHGMAPI	TOPS Schedule Charge Mapping Inactive Table
CHGRATE	Charge Rate Table
CHKDIGIT	TOPS Domestic Credit Card Check Digit Table
CICGRP	Carrier Identification Code Group Table
CICSETS	Carrier Identification Code Sets Table
CICSIZE4	Carrier Identification Code Size Four Table
CISCATAP	Commonwealth of Independent States Category Access Privileges Table
CITYMAP	TOPS City Map Table
CITYNUM	TOPS City Number Table
CITYWIDE	Business Group and City-wide Area to Site Mapping Table
CITYZONE	TOPS City Zone Table
CKTDIGIT	Circuit Digit Table
CLASSDEF	TOPS Call Type Table
CLASSNAM	TOPS Call Class Table
CLASSTYP	ITOPS Call Class Type Table
CLDNPA	TOPS Called NPA and Calling Tariff to Rate Type Table
CLDNPAEX	TOPS Called NPA-Nxx and Calling Tariff to Rate Type Table
CLDNPAEXI	TOPS Called NPA-Nxx and Calling Tariff to Rate Type Inactive Table
CLDNPAI	TOPS Called NPA and Calling Tariff to Rate Type Inactive Table
CLGATTR	Calling Party Attribute Table
CLGSET	TOPS Zenith Calling Point Set Table
CLGSSET	ITOPS Rating Rate Step Calculator Calling Area Schedule Set Table
CLGTRF	TOPS Calling NPA Nxx to Tariff Table

3-12 Master list of data schema tables

Table 3-1 (Sheet 12 of 87)

Short name	Title
CLIDN	Calling Line Identification Table
CLISERV	Calling Line Identification Screening Service Table (MMP only)
CLISRVPF	Calling Line Identifier Screening Profile Table (MMP only)
CLLI	Common Language Location Identifier Table
CLLIMTCE	CLLI Maintenance Table
CLLIMTCE.DIAGDATA	CLLI Maintenance Diagnostic Data Subtable
CLSVSCRC	Class of Service Screening Control Table
CLSVSCRC.CLSVSCR	Class of Service Screening Subtable
CMDS	Command Screening Table
CMGRING	Call Management Group Ringing Table
CMSHELF	Computing Module Shelves Table
CMVMWI	Common Voice Mailbox Message Waiting Indication Table
CNALDSPK	Calling Number Announcement to a Loudspeaker Table
CNGROUP	Called Number Group Table
COANISCR	Company ANI Screening Table
CODEBLK	Code Blocking Table
CODECALL	Code Calling Table
COMP CODE	Company Code Table
CONF3PR	Three-Port Conference Circuit Table
CONF6PR	Six-Port Conference Circuit Table
COSDATA	Network Class of Service Data Table
COSMAP	Network Class of Service Mapping Table
COUNTRY	TOPS Overseas Number to Country Name Mapping Table
CPCCHAR	Calling Party Category Characteristic Table (MMP only)
CPCIXLA	Calling Party Category IBN Translations Table (MMP only)
CPCUXLA	Calling Party Category Universal Translations Table (MMP only)

Table 3-1 (Sheet 13 of 87)

Short name	Title
CPOS	CAMA Position Trunk Circuit Table
CPOSTIME	CAMA Position Timing Table
CRSFMT	Call Record Stream Format Table
CRSMAP	Call Record Stream Mapping Table
CSDDSCUG	Circuit-Switched Digital Data Service Closed User Group Table
CSUSP	TOPS CAMA Suspension Circuit Table
CT4QAUTO	Call Type for Queuing by Automated Service Table
CT4QBLST	Call Type for Queuing Billing Satisfied Table
CT4QCALT	Call Type for Queuing by Call Type Category Table
CT4QCAR	Call Type for Queuing by Inter-LATA Carrier Table
CT4QCLAS	Call Type for Queuing by Class of Service Table
CT4QCLD	Call Type for Queuing by Called Number Table
CT4QLANG	Call Type for Queuing by Language Table
CT4QNAMS	Call Type for Queuing by Names Table
CT4QORIG	Call Type for Queuing by Originating Location Table
CT4QPFXT	Call Type for Queuing by Prefix Call Type Table
CT4QREST	Call Type for Queuing by Restricted Billing Index Table
CT4QSLRN	Call Type for Queuing Special Location Routing Number Table
CT4QSPID	Call Type for Queuing Service Provider Identifier Table
CT4QTIME	Call Type for Queuing by Time of Day of Week Table
CTCODE	Country Code Table
CTHEAD	Country Code Head Table
CTRLTMRS	Timeouts by Translation Class Table
CTRTE	Country Code Route Table
CUGCOMP	Closed User Group Compatibility Table
CUGINFO	Closed User Group Information Table

Table 3-1 (Sheet 14 of 87)

Short name	Title
CURRCONV	Currency Conversion Table (MMP only)
CUSTAB	Customer Table
CUSTACD	Customer Group Automatic Call Distribution Table
CUSTANN	Customer Group Announcement Table
CUSTANNS	Customized Announcements Table
CUSTCONS	Customer Group Attendant Console Option Table
CUSTENG	Customer Group Engineering Table
CUSTFAM	Customer Group Family Table
CUSTHEAD	Customer Group Head Table
CUSTNAME	Customer Name Table
CUSTNTWK	Customer Group Network Table
CUSTPROT	Customer Protection Table
CUSTSMR	Customer Group SMDR Option Table
CUSTSTN	Customer Group Station Option Table
CUSTSTN(3WCFLSH)	Three-way Calling with Single Flash DroP (Option 3WCFLSH) Table
CUSTSTN(800EOD)	800 Plus End Office Display (Option 800EOD) Subtable
CUSTSTN(ACB)	Automatic Call Back (Option ACB) Subtable
CUSTSTN(AIN)	Advanced Intelligent Network (Option AIN) Subtable
CUSTSTN(AINLATA)	Advanced Intelligent Network Local Access and Transport Area (Option AINLATA) Subtable
CUSTSTN(AMBISC)	Variable Speed Calling Access Code (Option AMBISC) Subtable
CUSTSTN(AMBZERO)	Ambiguous Digit 0 (Option AMBZERO) Subtable
CUSTSTN(AMSG)	Access to Messaging (Option AMSG) Subtable
CUSTSTN(AMSGDENY)	Access to Messaging Deny (Option AMSGDENY) Subtable
CUSTSTN(AR)	Automatic Recall (Option AR) Subtable
CUSTSTN(ASP)	Alternate Service Provider (Option ASP) Subtable

Table 3-1 (Sheet 15 of 87)

Short name	Title
CUSTSTN(ASR)	Automatic Set Relocation (Option ASR) Subtable
CUSTSTN(AUTODISP)	Automatic Display Mode (Option AUTODISP) Subtable
CUSTSTN(CBQ)	Call Back Queuing (Option CBQ) Subtable
CUSTSTN(CFCW)	Call Forwarding of Call Waiting (Option CFCW) Subtable
CUSTSTN(CFDATM)	Call Forward Don't Answer Timeout (Option CFDATM) Subtable
CUSTSTN(CFDCET)	Call Forward Don't Answer Continue Existing Treatment Enhancements with SS7 (Option CFDCET) Subtable
CUSTSTN(CFIND)	Call Forward Indication (Option CFIND) Subtable
CUSTSTN(CFRA)	Call Forwarding - Remote Access (Option CFRA) Subtable
CUSTSTN(CFWVAL)	IBN Call Forwarding Validation (Option CFWVAL) Subtable
CUSTSTN(CFXFEAT)	Call Forwarding Features (Option CFXFEAT) Subtable
CUSTSTN(CFXOL)	Call Forwarding Optional Lines (Option CFXOL) Subtable
CUSTSTN(CFXOPT)	Call Forwarding Option (Option CFXOPT) Subtable
CUSTSTN(CHD)	Call Hold with Audio (Option CHD) Subtable
CUSTSTN(CMCF)	Control of Multiple Call Forwarding (Option CMCF) Subtable
CUSTSTN(CNAB)	Calling Name Delivery Blocking (Option CNAB) Subtable
CUSTSTN(CNDB)	Calling Name and Number Delivery Blocking per Call (Option CNDB) Subtable
CUSTSTN(CNDBO)	(Option CNDBO) Calling Number Delivery Blocking Override Subtable
CUSTSTN (CNDBRI)	Calling Number Delivery Customer Group Control for Basic Rate Interface (Option CNDBRI) Subtable
CUSTSTN(COT)	Customer Originated Trace (Option COT) Subtable
CUSTSTN(CPARK)	Call Park (Option CPARK) Subtable
CUSTSTN(CRINTER)	Call Request Intergroup (Option CRINTER) Subtable
CUSTSTN(CRRNOKSH)	Call Request Retrieve and Keypad Short Hunt Interaction Control (Option CRRNOKSH) Subtable
CUSTSTN(CSMI)	Call Screening, Monitoring and Intercept (Option CSMI) Subtable

Table 3-1 (Sheet 16 of 87)

Short name	Title
CUSTSTN(CTW)	CALL Transfer Warning (Option CTW) Subtable
CUSTSTN(CWD)	Dial - Call Waiting (Option CWD) Subtable
CUSTSTN(CWO)	Call Waiting - Originating (Option CWO) Subtable
CUSTSTN(CWTC)	Call Waiting Conference (Option CWTC) Subtable
CUSTSTN(CXFER)	Call Transfer (Option CXFER) Subtable
CUSTSTN(CXFERSUP)	Call Transfer Enhanced (Option CXFERSUP) Subtable
CUSTSTN(DCBITONE)	Directed Call Pickup - Barge In Tone (Option DCBITONE) Subtable
CUSTSTN(DENYCWTC)	Deny Call Waiting Conference (Option DENYCWTC) Subtable
CUSTSTN(DINALT)	Denied Incoming Alternate Treatment (Option DINALT) Subtable
CUSTSTN(DISPDIGS)	Display Digits (Option DISPDIGS) Subtable
CUSTSTN(DISSTCWTN)	Distinctive Call Waiting Tone (Option DISSTCWTN) Subtable
CUSTSTN(DMCT)	Deny Malicious Call Termination (Option DMCT) Subtable
CUSTSTN(DND)	Do Not Disturb (Option DND) Subtable
CUSTSTN(DRING)	Distinctive Ring (Option DRING) Subtable
CUSTSTN(EBOM)	Executive Busy Override on Multiple Appearance Directory Number (Option EBOM) Subtable
CUSTSTN(GICNOCFW)	Group Intercom No Call Forwarding (Option GICNOCFW) Subtable
CUSTSTN(GICPAGE)	Group Intercom Page (Option GICPAGE) Subtable
CUSTSTN(INSPECT)	Inspect Activate Timer (Option INSPACT) Subtable
CUSTSTN(INSPPDISP)	Inspect Display Timer (Option INSPDISP) Subtable
CUSTSTN(ISA)	In-Session Activation (Option ISA) Subtable
CUSTSTN(JCNDFORM)	Japan Calling Number Delivery Format (Option JCNDFORM) Subtable
CUSTSTN(KSMOH)	Keypad Music On Hold (Option KSMOH) Subtable
CUSTSTN(LSPAOW)	Local Service Provider Account Owner (Option LSPAOW) Subtable
CUSTSTN(LSPSO)	Local Service Provider Switch Owner (Option LSPSO) Subtable
CUSTSTN(MBSCAMPO)	MBS Camp-on (Option MBSCAMPO) Subtable

Table 3-1 (Sheet 17 of 87)

Short name	Title
CUSTSTN(MCGROUP)	Electronic Business Sets as a Message Center (Option MCGROUP) Subtable
CUSTSTN(MSB)	Make Set Busy (Option MSB) Subtable
CUSTSTN(N3WCRRNG)	No Ringback for Three-way Call (Option N3WCRRNG) Subtable
CUSTSTN(NAMEDISP)	Name Display (Option NAMEDISP) Subtable
CUSTSTN(NFA)	Network Facility Access (Option NFA) Subtable
CUSTSTN(NFRA)	Network Facility Remote Access (Option NFRA) Subtable
CUSTSTN(NUMDGCMP)	Network EBS Display (Option NUMDGCMP) Subtable
CUSTSTN(PCACIDS)	Privacy Change Allowed Caller ID Delivery and Suppression (Option PCACIDS) Subtable
CUSTSTN(PCSOPT)	Personal Call Screening Option (Option PCSOPT) Subtable
CUSTSTN(PHOLD)	Permanent Hold (Option PHOLD) Subtable
CUSTSTN(RAGRCOPT)	Ring Again Recall (Option RAGRCOPT) Subtable
CUSTSTN(RAGTIM)	Ring Again Timer (Option RAGTIM) Subtable
CUSTSTN(READISP)	Reason Display (Option READISP) Subtable
CUSTSTN(REDIRECT)	Customer Group with No Consoles (Option REDIRECT) Subtable
CUSTSTN(RND)	Redirecting Number and Reason Delivery (Option RND) Subtable
CUSTSTN(SCPAUSE)	Speed Call Pause (Option SCPAUSE) Subtable
CUSTSTN(SCUTDNO)	Speed Call User Toll Denied Override (Option SCUTDNO) Subtable
CUSTSTN(SCVAL)	Speed Calling Validation (Option SCVAL) Subtable
CUSTSTN(SDS)	Special Delivery Service (Option SDS) Subtable
CUSTSTN(SDSDENY)	Special Delivery Service Deny (Option SDSDENY) Subtable
CUSTSTN(SERVCTL)	Scope Control (Option SERVCTL) Subtable
CUSTSTN(SLE)	Screening List Editing (Option SLE) Subtable
CUSTSTN(SOR)	Station Origination Restrictions (Option SOR) Subtable
CUSTSTN(SPP)	Station Programmable PIN (Option SPP) Subtable
CUSTSTN(TAFAS)	Trunk Answer from Any Station (Option TAFAS) Subtable

Table 3-1 (Sheet 18 of 87)

Short name	Title
CUSTSTN (USAID)	BAS SAID Universal Access (Option USAID) Subtable
CUSTTIID	Customer Group Trigger Item Identification Table
CUSTVCDR	Customer Group Variable Call Detail Recording Table
CUSTXTRA	Customer Extra Table
CXGRP	Customer Group Options Table
D3MAINTD	DMS-300 Maintenance Data Table
DABILL	Directory Assistance Billing Table
DACCLRS	Directory Assistance Call Completion Local Rate Step Table
DACCLRSI	Directory Assistance Call Completion Local Rate Step Inactive Table
DACCSUR	Directory Assistance Call Completion Surcharge Table
DACCSURI	Directory Assistance Call Completion Surcharge Inactive Table
DANIID	Double ANI Identification Table
DARSTBIL	Directory Assistance Restricted Billing Table
DART	Dump and Restore Table
DATAOWNER	Data Owner Table
DATAOWNER(AUTHPART)	Authorization Code Partition Names (Datafill for AUTHPART) Subtable
DATAOWNER(COSMAP)	Electronic Switched Network Class of Service Screening (Datafill for COSMAP) Subtable
DATAOWNER(CUSTHEAD)	Customer Groups (Datafill for CUSTHEAD) Subtable
DATAOWNER(DIGCOL)	Digit Collection (Datafill for DIGCOL) Subtable
DATAOWNER(DIGMAN)	Digit Manipulation Indices (Datafill for DIGMAN) Subtable
DATAOWNER(FTRGDEFS)	Feature Groups (Datafill for FTRGDEFS) Subtable
DATAOWNER(HNPACONT or FNPACONT)	Serving Translation Schemes (Datafill for HNPACONT or FNPACONT) Subtable
DATAOWNER(IBNRTE, IBNRTE2, IBNRTE3, IBNRTE4)	Integrated Business Network Routes (Datafill for IBNRTE, IBNRTE2, IBNRTE3, IBNRTE4) Subtable

Table 3-1 (Sheet 19 of 87)

Short name	Title
DATAOWNR(LCASCRCN)	Local Calling Areas (Datafill for LCASCRCN) Subtable
DATAOWNR(LINEATTR)	Line Attributes (Datafill for LINEATTR) Subtable
DATAOWNR(LSCFLAGS)	Line Screening Code Flag Numbers (Datafill for LSCFLAGS) Subtable
DATAOWNR(NCOS)	Line Screening Codes (Datafill for NCOS) Subtable
DATAOWNR(OWNER)	Owners (Datafill for OWNER) Subtable
DATAOWNR(PACMAN)	Protocol Manipulation Indexes (Datafill for PACMAN) Subtable
DATAOWNR(SCRNCLAS)	Screening Classes (Datafill for SCRNCLAS) Subtable
DATAOWNR(STDPRTCT)	Pretranslator Name (Datafill for STDPRTCT) Subtable
DATAOWNR(TODHEAD)	Time of Day System Names (Datafill for TODHEAD) Subtable
DATAOWNR(TRKGRP and FNMAP)	Trunk Groups (Datafill for TRKGRP and FNMAP) Subtable
DATAOWNR(VFGDATA)	Virtual Facility Group Data (Datafill for VFGDATA) Subtable
DATAOWNR(VIRTGRPS)	Virtual Facility Groups (Datafill for VIRTGRPS) Subtable
DATAOWNR(XLANAME)	Translator Names (Datafill for XLANAME) Subtable
DATASIZE	Data Size Table
DATRKOPT	Directory Assistance Trunk Options Table
DAYOFWK	Day of Week Table
DAYOWEEK	Day of Week Table
DAYOYEAR	Day of Year Table
DAYTYPES	Type of Day Table
DCACCTL	Destination Code Access Control Table
DCACNM	Destination Code Access Control Names Table
DCANETID	Dynamically Controlled Access (DCA) Network Table **TABLE OBSOLETE
DCDINFO	Dialed Category Digit Information Table
DCHINV	D-Channel Handler Inventory Table
DCICDEF	Disallowed Card Issuer Code Definition Table

Table 3-1 (Sheet 20 of 87)

Short name	Title
DCICSET	Disallowed Card Issuer Code Table
DCMEINV	Digital Circuit Multiplication Equipment Inventory Table
DCMEMTC	Digital Circuit Multiplication Equipment Maintenance Table
DCMINV	Digital Carrier Module Inventory Table
DCNTAB	Data Change Notification Table
DCOUNT	TOPS Discounts Table
DCOUNTI	TOPS Discounts Inactive Table
DCRNETID	Dynamically Controlled Routing Network Identification Table
DCROPT	Dynamically Controlled Routing Mode of Operation Control Table
DCTDIAL	Data Call Tester Dialing Table
DCTS	Destination Code Traffic Summary Table
DDTAB	Data Dictionary Table
DDU	Disk Drive Unit Table
DEFDATA	Default Data Table
DELAYOP	TOPS Delayed Outpulsing Table
DESTCTL	Destination Control Table
DESTKEY	Dynamically Controlled Routing Destination Node Names Table
DESTNM	Destination Control Names Table
DESTNODE	Dynamically Controlled Routing Destination Office Route Table
DFINV	Distribution Frame Inventory Table
DGCODE	Digit Analysis Code Table
DGHEAD	Digit Analysis Head Table
DIALBACK	Automatic Dial Back Table
DIALPLAN	Dialing Plan Table
DIGCOL	IBN Digit Collection Table
DIGMAN	Digit Manipulation Table

Table 3-1 (Sheet 21 of 87)

Short name	Title
DIRPHOLD	DIRP Hold Table
DIRPOOL	DIRP Pool Table
DIRPSSYS	DIRP Subsystem Table
DISTANCE	Distance Table
DIUAM	Digital Interworking Unit Access Module Table
DIUCONN	Digital Interworking Unit Connections Table
DLCDEV	Data Link Controller Device Table
DLMINV	Digital Line Module Inventory Table
DMCTLIST	Deny Malicious Call Termination List Table
DMODEM	Digital Modem Table
DNATTRS	Directory Number Attributes Table
DNBKSUR	Directory Number Blocking Surcharge Table
DNBKSURI	Directory Number Blocking Surcharge Inactive Table
DNCHNL	Directory Number Channel Type Table
DNCODE	Directory Number Code Table
DNCTINFO	Directory Number Call Type Information Table
DNDMSB	Do Not Disturb Make Set Busy
DNDSCHED	Do Not Disturb Schedule Table
DNFEAT	Directory Number Features Table
DNGRPS	Directory Number Groups Table
DNHEAD	Directory Number Head Table
DNIBERT	Directory Number Integrated Bit Error Ratio Test Table
DNINV	Directory Number Inventory Table
DNLPIC	Directory Number Primary Intra-LATA Carrier Table
DNOWN	Directory Number Owner Table
DNPIC	Directory Number Primary Inter-LATA Carrier Table

Table 3-1 (Sheet 22 of 87)

Short name	Title
DNPORT	Directory Number Ported Out Table (MMP only)
DNREGION	Directory Number Region Table
DNREVXLA	Directory Number Reverse Translation Table
DNROUTE	Directory Number Route Table
DNROUTE(ACD)	Automatic Call Distribution (Feature ACD) Subtable
DNROUTE(AIN)	Advanced Intelligent Network (Feature AIN) Subtable
DNROUTE(ASR)	Automatic Set Relocation (Feature ASR) Subtable
DNROUTE(D)	Directory Number Selector D (Feature D) Subtable
DNROUTE(DISA)	Direct Inward Service Access (Feature DISA) Subtable
DNROUTE(DNTRIG)	Directory Number Trigger (Feature DNTRIG) Subtable
DNROUTE(DSVC)	Default Service (Feature DSVC) Subtable
DNROUTE(M)	Directory Number Selector M (Feature M) Subtable
DNROUTE(MCDN)	Message Center Directory Number (Feature MCDN) Subtable
DNROUTE(MM)	Directory Number Selector MM (Feature MM) Subtable
DNROUTE(MONA)	Meridian OffNet Access (Feature MONA) Subtable
DNROUTE(MSR)	Message Storage and Retrieval (Feature MSR) Subtable
DNROUTE(RSDT)	Directory Number Selector Restricted Dial Tone (Feature RSDT) Subtable
DNROUTE(SPRING)	Subscriber Programmable Ringing for CFDA (Feature SPRING) Subtable
DNROUTE(SRA)	Suppressed Ringing Access (Feature SRA) Subtable
DNROUTE(SYN)	Synonym Directory Number (Feature SYN) Subtable
DNROUTE(T)	Directory Number Selector T (Feature T) Subtable
DNROUTE(UCD)	Uniform Call Distribution (Feature UCD) Subtable
DNRTE	Directory Number Route Table
DNRTEID	Directory Number Route Identifier Table
DNSCRN	Directory Number Screening Table

Table 3-1 (Sheet 23 of 87)

Short name	Title
DOMBILL	TOPS Domestic Billing Restrictions Table
DPACDEV	Datapac Device Table
DPCTSCRN	Dial Plan and Call Type Screening Table
DPNSSLK	Digital Private Network Signaling System Link Table
DPP	Distributed Processing Peripheral Table
DPROFILE	Data Unit Profile Table
DPROFILE(AILC)	Asynchronous Interface Line Card (Type AILC) Subtable
DPROFILE(CCU)	Controller COAX Unit (Type CCU) Subtable
DPROFILE(CMADO)	Continuous Calling Meridian Asynchronous Data Option (Type CMADO) Subtable
DPROFILE(DAVLC)	Data Above Voice Line Card (Type DAVLC) Subtable
DPROFILE(HS)	High-Speed Data Unit (Type HS) Subtable
DPROFILE(HSEXT or LSEXT)	High-Speed Loop Extended Data Unit or Low-Speed Extended Data Unit (Type HSEXT or LSEXT) Subtable
DPROFILE(LS)	Low-Speed Data Unit (Type LS) Subtable
DPROFILE(MADO)	Meridian Asynchronous Data Option (Type MADO) Subtable
DPROFILE(MP)	Modem Pool Data Unit (Type MP) Subtable
DPROFILE(MPDA)	Meridian Programmable Data Adaptor (Type MPDA) Subtable
DPROFILE(TCU)	Terminal COAX Unit (Type TCU) Subtable
DQMODEM	Dial-Up Autoquote Modem Table
DRAMS	Digital Recorded Announcement Machine Table
DRAMPHRS	Digital Recorded Announcement Machine Phrases Table
DRAMTRK	Digital Recorded Announcement Machine Track Table
DRMAPPL	Distributed Recording Manager Applications Table
DRMPOOL	Distributed Recording Manager Pool Table
DRMTRANS	DIRP to DRM Translation Table
DRMUSERS	Digital Recorded Announcement Machine Users Table

Table 3-1 (Sheet 24 of 87)

Short name	Title
DS	Data Store Assignment Table
DSCWDTYP	Deluxe Spontaneous Call Waiting Identification Types Table
DSLIMIT	Data Store Limit Table
DSTTABLE	Automated Time-of-Day Change Table
DTUPRO	Data Terminal Unit Protocol Name Definition Table
DUAQOPT	Dial-Up Autoquote Office Parameter Table
DVIINV	DVS DS30 Interface Inventory Table
DVSINV	DVS Lineup Inventory Table
E911ALI	Enhanced 911 Direct Access to AT&T ALI Controller Table
E911ESN	Enhanced 911 Emergency Service Number Table
E911NPD	Enhanced 911 Numbering Plan Digit Table
E911OFC	Enhanced Network 911 Office Table
E911PSAP	Enhanced 911 Public Safety Answering Point Table
E911RCER	Enhanced 911 Remote Call Event Record Table
E911SRDB	Enhanced 911 Selective Routing Database Table
EAACTSAN	Equal Access Automated Coin Toll Service Announcement Table
EAANIID	TOPS Equal Access ANI ID Digits Table
EADAS	Engineering and Administrative Data Acquisition System Table
EADNMPK	EADAS/NM Interface Packet Schedule Table
EADNMTG	EADAS/NM Interface Current Trunk Group Schedule Table
EADNMTGP	EADAS/NM Interface Pending Trunk Group Schedule Table
EAMCCSAN	Equal Access Mechanized Calling Card Service Announcement Table
EAREGN	Equal Access Region Table
EASAC	Equal Access Service Access Codes Table
EASCRN	Equal Access Screening Table
ECHCONF	Echo Canceler Module Configuration Table

Table 3-1 (Sheet 25 of 87)

Short name	Title
ECHINV	Echo Canceler Module Inventory Table
ECHOSUP	Digital Echo Suppressor Member List Table
EDRAMINV	Enhanced Digital Recording Machine Inventory Table
EMRDIGS	Emergency Region Digits (MMP only)
ENCDINV	Enhanced Network Card Inventory Table
ENINV	Enhanced Network Node Inventory Table
ENSITES	External Node Sites Table
ENTYPES	External Node Types Table
EOCDB	Embedded Operations Channel Database Table
ESA	Emergency Stand-alone Table
ESAHNPA	Emergency Stand-alone Home Numbering Plan Table
ESAPXLA	Emergency Stand-alone Prefix Translation Table
ESARTE	Emergency Stand-alone Routing Table
ESRVATTR	Enhanced Services Attributes Table
ESRVCAP	Enhanced Services Capacities Table
ETSIFEAT	ETSI Feature Table
EXNDAPPL	External Node Application Table
EXNDINV	External Node Inventory Table
FACODE	Foreign Area Code Table
FAHEAD	Foreign Area Code Head Table
FAILMSG	Mapping Fail Messages Between Protocols Table
FAIL2STG	Two-stage Call Failure Treatment Mapping Table (MMP only)
FAIL2TMT	Fail Messages to Treatment Table (MMP only)
FARTE	Foreign Area Code Route Table
FDCPLSTM	Line Signaling Protocol Timers Table (MMP only)
FDCPLSVR	Line Signaling Variant Table (MMP only)

Table 3-1 (Sheet 26 of 87)

Short name	Title
FDCPLSWF	Line Signaling Waveform Characteristics Table (MMP only)
FEATCHG	International Line Feature Metering Table
FEATDESC	Feature Description Table
FGBCIC	Feature Group B Carrier Identification Code Table
FIXEDANI	Outgoing & Two-way R2 CAMA Trunk Fixed ANI Table
FLEXAMA	Flexible Automatic Message Accounting Table
FMRESINV	Facility Maintenance Resource Inventory Table
FMRESUSE	Facility Maintenance Resource Users Table
FMTINV	Enhanced Fiber Monitoring Inventory Table
FMTMAP	Enhanced Fiber Monitoring MAP Table
FMTSC	Enhanced Fiber Monitoring Scan Table
FNMAP	Attendant Console Functional Key Table
FNMAP(ACC)	Account Code Entry (Selector SPECL ACC) Subtable
FNMAP(ACEES)	Attendant Console End-to-End Signaling (Selector SPECL ACEES) Subtable
FNMAP(AUTH)	Authorization Code (Selector SPECL AUTH) Subtable
FNMAP(AUTOD)	Attendant Autodial (Selector SPECL AUTOD) Subtable
FNMAP(AUVAL)	Authorization Code Validation (Selector SPECL AUVAL) Subtable
FNMAP(BUZZ)	Flexible Console Alerting (Selector SPECL BUZZ) Subtable
FNMAP(BVL)	Busy Verification Line (Selector SPECL BVL) Subtable
FNMAP(BVT)	Busy Verification Trunk (Selector SPECL BVT) Subtable
FNMAP(CFS)	Attendant Activate, Deactivate and Program Call Forwarding (Selector SPECL CFS) Subtable
FNMAP(CONF)	Conference Call (Selector SPECL CONF) Subtable
FNMAP(DND)	Do Not Disturb (Selector SPECL DND) Subtable
FNMAP(DQC)	Display Queued Calls (Selector SPECL DQC) Subtable
FNMAP(DSPC)	Key and Lamp Display (Selector SPECL DSPC) Subtable

Table 3-1 (Sheet 27 of 87)

Short name	Title
FNMAP(GTAC)	Group Trunk Access Control (Selector SPECL GTAC) Subtable
FNMAP(GTGB)	Group Trunk Group Busy (Selector SPECL GTGB) Subtable
FNMAP(GVAC)	Global Virtual Facility Group Access Control (Selector SPECL GVAC) Subtable
FNMAP(GVGB)	Global Virtual Facility Group Busy (Selector SPECL GVGB) Subtable
FNMAP(ICICODE)	Incoming Call Identification Code (Selector SPECL ICICODE) Subtable
FNMAP(LANG)	Flexible Display Language (Selector SPECL LANG) Subtable
FNMAP(LOGIN)	Login (Selector SPECL LOGIN) Subtable
FNMAP(MSGIND)	Message Waiting (Selector SPECL MSGIND) Subtable
FNMAP(NAME)	Name Display (Selector SPECL NAME) Subtable
FNMAP(NSPRG)	Night Service Programming (Selector SPECL NSPRG) Subtable
FNMAP(PARK)	Parking of Calls by Attendant (Selector SPECL PARK) Subtable
FNMAP(POS)	Position Busy (Selector SPECL POS) Subtable
FNMAP(PVNAUTH)	Private Virtual Network Authorization Code (Selector SPECL PVNAUTH) Subtable
FNMAP(PVNRMAC)	Private Virtual Network Remote Access Call Attendant (Selector SPECL PVNRMAC) Subtable
FNMAP(PVNSRCDN)	Private Virtual Network Calling Number Attendant Assistance (Selector SPECL PVNSRCDN) Subtable
FNMAP(SC10, SC30, SC50, SC70 or SCU)	Speed Calling List (Selector SPECL SC10, SC30, SC50, SC70 or SCU) Subtable
FNMAP(SERIAL)	Serial Calling (Selector SPECL SERIAL) Subtable
FNMAP(SORC)	Station Origination Restrictions Controller (Selector SPECL SORC) Subtable
FNMAP(TIME)	Attendant Query Time and Date (Selector SPECL TIME) Subtable
FNMAP(TRBL)	Trouble Code (Selector SPECL TRBL) Subtable
FNMAP(UNPK)	Unparking of Calls by Attendant (Selector SPECL UNPK) Subtable
FNMAP(WC)	Wild Card (Selector SPECL WC) Subtable

Table 3-1 (Sheet 28 of 87)

Short name	Title
FNMAP(TAC)	Trunk Access Control (Selector TAC) Subtable
FNMAP(TGB)	Trunk Group Busy (Selector TGB) Subtable
FNMAP(VAC)	Virtual Facility Group Access Control (Selector VAC) Subtable
FNMAP(VGB)	Virtual Facility Group Busy (Selector VGB) Subtable
FNPA7DIG	Foreign Numbering Plan Area 7-Digit Number Table
FNPACONT	List of Foreign Numbering Plan Area Codes Subtables Table
FNPACONT.FNPACODE	Foreign NPA Codes Subtable
FNPACONT.FNPASTS	List of Foreign NPA STS Codes Subtables Subtable
FNPACONT.FNPASTS. RTEREF	Foreign NPA STS Route Reference Subtable
FNPACONT.FNPASTS. STSCODE	Foreign NPA STS Codes Subtable
FNPACONT.RTEREF	Foreign NPA Route Reference Subtable
FPDEVINV	File Processor Device Inventory Table
FPDIPINV	File Processor Device Interface Paddle Board Inventory Table
FPHOPT	Freephone Option Table
FRSACCCN	Frame Relay Service Access Point Connections Table
FRSCCTRL	Frame Relay Service Congestion Control Table
FRSCIR	Frame Relay Service Committed Information Rate Table
FRSCNEND	Frame Relay Service Connection End Table
FRSTRKCN	Frame Relay Service Connections for T1 Trunks Table
FRSTRKGP	Frame Relay Service for T1 Trunk Group Table
FRSTRKS	Frame Relay Service for T1 Trunks Table
FTCODE	Utility Code Table
FTHEAD	Utility Code Head Table
FTRANDEV	File Transfer Device Table
FTRGDEFS	Feature Group Definitions Table

Table 3-1 (Sheet 29 of 87)

Short name	Title
FTRGMEMS	Feature Group Members Table
FTRGOPTS	Feature Group Options Table
FTRGOPTS(3WCPUB)	Three-way Calling Public (Option 3WCPUB) Subtable
FTRGOPTS(ACB)	Automatic Callback (Option ACB) Subtable
FTRGOPTS(AR)	Automatic Recall (Option AR) Subtable
FTRGOPTS(AUD)	Automatic Dialing (Option AUD) Subtable
FTRGOPTS(AUTODISP)	Automatic Display (Option AUTODISP) Subtable
FTRGOPTS(CFB)	Call Forward Busy (Option CFB) Subtable
FTRGOPTS(CFBL)	Call Forward Busy Line (Option CFBL) Subtable
FTRGOPTS(CFD)	Call Forward Don't Answer IBN (Option CFD) Subtable
FTRGOPTS(CFDA)	Call Forward Don't Answer (Option CFDA) Subtable
FTRGOPTS(CFDVT)	Call Forward Don't Answer Variable Timer (Option CFDVT) Subtable
FTRGOPTS(CFI)	Call Forward Intragroup (Option CFI) Subtable
FTRGOPTS(CFK)	Call Forward per Key (Option CFK) Subtable
FTRGOPTS(CFS)	Call Forward Simultaneous/Screening (Option CFS) Subtable
FTRGOPTS(CFU)	Call Forward Universal (Option CFU) Subtable
FTRGOPTS(CFW)	Call Forward (Option CFW) Subtable
FTRGOPTS(CLID)	Calling Line Identification (Option CLID) Subtable
FTRGOPTS(CLIDSP)	Calling Line Identification Display (Option CLIDSP) Subtable
FTRGOPTS(CMCF)	Call of Multiple Call Forward (Option CMCF) Subtable
FTRGOPTS(CNAMD)	Calling Name Delivery (Option CNAMD) Subtable
FTRGOPTS(CND)	Calling Number Delivery (Option CND) Subtable
FTRGOPTS(CNDB)	Calling Number Delivery Blocking (Option CNDB) Subtable
FTRGOPTS(CNF)	Flexible Station Controlled Conference (Option CNF) Subtable
FTRGOPTS(COT)	Customer Originated Trace (Option COT) Subtable
FTRGOPTS(CXR)	Call Transfer (Option CXR) Subtable

Table 3-1 (Sheet 30 of 87)

Short name	Title
FTRGOPTS(DDN)	Dialable Delivery Number (Option DDN) Subtable
FTRGOPTS(FXR)	Fast Transfer (Option FXR) Subtable
FTRGOPTS(MWT)	Message Waiting (Option MWT) Subtable
FTRGOPTS(NAMEDSP)	Name Display (Option NAMEDSP) Subtable
FTRGOPTS(OLS)	Originating Line Select (Option OLS) Subtable
FTRGOPTS(OPTS)	Various Line Options (Option OPTS) Subtable
FTRGOPTS(PF)	Power Features (Option PF) Subtable
FTRGOPTS(PFCNTL)	Power Features Control (Option PFCNTL) Subtable
FTRGOPTS(READSP)	Reason Display (Option READSP) Subtable
FTRGOPTS(SC1)	Speed Calling Short List (Option SC1) Subtable
FTRGOPTS(SC2)	Speed Calling Long List L30 (Option SC2) Subtable
FTRGOPTS(SC3)	Speed Calling Long List L50 (Option SC3) Subtable
FTRGOPTS(SCL)	Speed Calling Long List IBN (Option SCL) Subtable
FTRGOPTS(SCS)	Speed Calling Short List IBN (Option SCS) Subtable
FTRGOPTS(TLS)	Terminating Line Select (Option TLS) Subtable
FTRTE	Utility Code Route Table
FTSPCINV	Frame Transport System Point Code Inventory Table
FXDNMAP	Foreign Exchange Directory Number Map Table
G7MSGSET	GOSS7 Message Set Parameters Table
G7PARAM	Global Operating Signalling System Number 7 Parameters Table
GASINFO	General AFT System Information Table
GCASCRN	Global Competitive Access Screen
GCASSET	Global Competitive Access Schedule Set Name Table
GDLADEV	Generic Data Link Application Device Table
GPPTRNSL	Global Peripheral Platform (GPP) Translations Table
GWDIGMAN	Gateway Digit Manipulation Table

Table 3-1 (Sheet 31 of 87)

Short name	Title
HEAPTAB	Heap Table
HIEINV	Host Interface Equipment Inventory Table
HNPACONT	List of Home NPA Code Subtables Table
HNPACONT.ATTRIB	Home NPA Longhaul Attribute Subtable
HNPACONT.HNPACODE	Home NPA Code Subtable
HNPACONT.HNPACODE (AMBI)	Ambiguous Code (Type AMBI) Subtable
HNPACONT.HNPACODE (DN)	Terminating Line Code (Type DN) Subtable
HNPACONT.HNPACODE (FNPA)	Foreign Number Plan Area Code (Type FNPA) Subtable
HNPACONT.HNPACODE (FRTD and FRTE)	Foreign Number Plan Area Code (Type FRTD and FRTE) Subtable
HNPACONT.HNPACODE (HNPA)	Home Numbering Plan Code (Type HNPA) Subtable
HNPACONT.HNPACODE (HRTE)	Home Route Code (Type HRTE) Subtable
HNPACONT.HNPACODE (INWC, INWO)	iNWATS Originating Code (Types INWC, INWO) Subtable
HNPACONT.HNPACODE (INWS)	INWATS Terminating Code (Type INWS) Subtable
HNPACONT.HNPACODE (INWT)	INWATS Tandem Code (Type INWT) Subtable
HNPACONT.HNPACODE (LRTE)	Local Route Code (Type LRTE) Subtable
HNPACONT.HNPACODE (NPOSDN)	No Position to DN Code (Type NPOSDN) Subtable
HNPACONT.HNPACODE (NSC)	Number Service Code (Type NSC) Subtable
HNPACONT.HNPACODE (OPC3, OPC4 and OPC5)	Operator Code (Types OPC3, OPC4 and OPC5) Subtable

Table 3-1 (Sheet 32 of 87)

Short name	Title
HNPACONT.HNPACODE (SACNWM)	Service Access Network Management Code (Type SACNWM) Subtable
HNPACONT.HNPACODE (SCD3, SCD4)	Three or Four Digit Local Service Codes (Types SCD3, SCD4) Subtable
HNPACONT.HNPACODE (SLRTE)	Special Local Route Code (Type SLRTE) Subtable
HNPACONT.HNPACODE (STRG)	Station Ringer Code (Type STRG) Subtable
HNPACONT.HNPACODE (TTC)	Terminating Toll Center Code (Type TTC) Subtable
HNPACONT.HNPACODE (VCT)	Vacant Code (Type VCT) Subtable
HNPACONT.RTEMAP	ISDN Home NPA Route Reference Subtable
HNPACONT.RTEREF	Home NPA Route Reference Subtable
HOBICDEV	Hotel Billing Information Center Device Table
HOLDAY	TOPS Holiday Table
HOLIDAY	ITOPS Rating Charge Calculator Holiday Table
HOLITRMT	ITOPS Rating Charge Calculator Holiday Treatment Table
HOLTRT	TOPS Holiday Treatment Table
HOLTRTI	TOPS Holiday Treatment Inactive Table
HOMELRN	Home Location Routing Number Table
HOTLIST	TOPS Domestic Hot List Table
HPWASTE	Heap Waste Table
HSMLINK	High Speed Modem Link Table
HUNTGRP	Hunt Group Table
HUNTMEM	Hunt Group Member Table
HWM	High Water Mark Table
IAACTRL	Interadministration Accounting Control Table

Table 3-1 (Sheet 33 of 87)

Short name	Title
IACINV	ISDN Access Controller Inventory Table
IACPSINV	ISDN Access Controller P-Side Inventory Table
IACREQ	Insert Area Code Required Table
IALTRTE	ITOPS International Alternate Routing Table
IANNINFO	Internal Announcement Information Table
IBNATD	IBN Audio Tone Detector Table
IBNFEAT	IBN Line Feature Table
IBNFEAT(3WCPUB)	Three-way Calling Pubic (Feature 3WCPUB) Subtable
IBNFEAT(ACD)	Automatic Call Distribution (Feature ACD) Subtable
IBNFEAT(ACRJ)	Anonymous Caller Rejection (Feature ACRJ) Subtable
IBNFEAT(AIN)	Advanced Intelligent Network (Feature AIN) Subtable
IBNFEAT(ASP)	Alternate Service Provider (Feature ASP) Subtable
IBNFEAT(AUL)	Automatic Line (Feature AUL) Subtable
IBNFEAT(BCLID)	Bulk Calling Line Identification (Feature BCLID) Subtable
IBNFEAT(CALLOG)	Call Log (Feature CALLOG) Subtable
IBNFEAT(CDT)	Custom IBN Disconnect Treatment (Feature CDT) Subtable
IBNFEAT(CFDVT)	Call Forwarding Do Not Answer Variable Timing (Feature CFDVT) Subtable
IBNFEAT(CFFPOVR)	Call Forward Fraud Prevention Override (Feature CFFPOVR) Subtable
IBNFEAT(CFIND)	Call Forwarding Indication (Feature CFIND) Subtable
IBNFEAT(CFTB)	Call Forward Timed for Call Forward Busy (Feature CFTB) Subtable
IBNFEAT(CFD)	Call Forward Timed for Call Forward Don't Answer (Feature CFD) Subtable
IBNFEAT(CFX)	Call Forwarding (Feature CFX) Subtable
IBNFEAT(CLI)	Calling Line Identification (Feature CLI) Subtable
IBNFEAT(CMG)	Call Management Group (Feature CMG) Subtable

Table 3-1 (Sheet 34 of 87)

Short name	Title
IBNFEAT(CNF)	Flexible Station Controlled Conference (Feature CNF) Subtable
IBNFEAT(CPU)	Call Pickup (Feature CPU) Subtable
IBNFEAT(CSMI)	Call Screening, Monitoring and Intercept (Feature CSMI) Subtable
IBNFEAT(CTD)	Carrier Toll Denied (Feature CTD) Subtable
IBNFEAT(CXR)	Call Transfer (Feature CXR) Subtable
IBNFEAT(DIN)	Denied Incoming (Feature DIN) Subtable
IBNFEAT(DMCT)	Deny Malicious Call Termination (Feature DMCT) Subtable
IBNFEAT(DND)	Do Not Disturb (Feature DND) Subtable
IBNFEAT(DRING)	Distinctive Ringing (Feature DRING) Subtable
IBNFEAT(ECM)	Extended Call Management (Feature ECM) Subtable
IBNFEAT(EMW)	Executive Message Waiting (Feature EMW) Subtable
IBNFEAT(FCTDINT)	Full Carrier Toll Deny for International Carriers (Feature FCTDINT) Subtable
IBNFEAT(FRO)	Fire Reporting System, Originating (Feature FRO) Subtable
IBNFEAT(FRS)	Sleeve Lead for Public Fire Reporting System (Feature FRS) Subtable
IBNFEAT(GIC)	Group Intercom (Feature GIC) Subtable
IBNFEAT(ISA)	In-Session Activation (Feature ISA) Subtable
IBNFEAT(LMOH)	Line Music on Hold (Feature LMOH) Subtable
IBNFEAT(LPIC)	Intra-LATA PIC (Feature LPIC) Subtable
IBNFEAT(LSPSO)	Local Service Provider Switch Owner (Feature LSPSO) Subtable
IBNFEAT(MBK)	Make Busy Key (Feature MBK) Subtable
IBNFEAT(MWT)	Message Waiting (Feature MWT) Subtable
IBNFEAT(NFA)	Network Facility Access (Feature NFA) Subtable
IBNFEAT(OBS)	Observe Agent form 500/2500 Set (Feature OBS) Subtable
IBNFEAT(PIC)	Primary Inter-LATA Carrier (Feature PIC) Subtable
IBNFEAT(RMB)	Random Make Busy (Feature RMB) Subtable

Table 3-1 (Sheet 35 of 87)

Short name	Title
IBNFEAT(RSUS)	Requested Suspension (Feature RSUS) Subtable
IBNFEAT(SACB)	Subscriber-Activated Call Blocking (Feature SACB) Subtable
IBNFEAT(SCL)	Speed Calling List Long (Feature SCL) Subtable
IBNFEAT(SCMP)	Series Completion (Feature SCMP) Subtable
IBNFEAT(SCS)	Speed Calling List Short (Feature SCS) Subtable
IBNFEAT(SDN)	Secondary Directory Number (Feature SDN) Subtable
IBNFEAT(SDY)	AT&T Line Study (Feature SDY) Subtable
IBNFEAT(SEC)	Security (Feature SEC) Subtable
IBNFEAT(SHU)	Stop Hunt (Feature SHU) Subtable
IBNFEAT(SimRing)	Simultaneous Ringing (Feature SimRing) Subtable
IBNFEAT(SLU)	Subscribers Line Usage (Feature SLU) Subtable
IBNFEAT(SMDI)	Simplified Message Desk Interface (Feature SMDI) Subtable
IBNFEAT(SOR)	Station Origination Restrictions (Feature SOR) Subtable
IBNFEAT(SPB)	Special Billing Code (Feature SPB) Subtable
IBNFEAT(SSAC)	Station-specific Authcode (Feature SSAC) Subtable
IBNFEAT(SUPR)	ACD Supervisor Position on 500/2500 Set (Feature SUBR) Subtable
IBNFEAT(TBO)	Terminating Billing Option (Feature TBO) Subtable
IBNFEAT(UCDSD)	UCD Signal Distribution Points (Feature UCDSD) Subtable
IBNFEAT(VMEADN)	Voice Mail Easy Access Directory Number (Feature VMEADN) Subtable
IBNFEAT(WML)	Warm Line for RES and MDC (Feature WML) Subtable
IBNFEAT(WUCR)	Wake-up Call Request (Feature WUCR) Subtable
IBNFXDS1	IBN Digital FX Trunk Subtable
IBNLINES	IBN Line Assignment Subtable
IBNLINES(AC)	Attendant Console (Option AC) Subtable
IBNLINES(BL)	Bulk Calling Line Identification (Option BL) Subtable

Table 3-1 (Sheet 36 of 87)

Short name	Title
IBNLINES(LNPTST)	Option Local Number Portability Test Call (LNPTST) Subtable
IBNLINES(MDN)	Multiple Appearance Directory Number (Option MDN) Subtable
IBNLINES(STN)	Station (Option STN) Subtable
IBNMAP	ISDN Routing Map Table
IBNMAP2	ISDN Routing Map-2 Table
IBNMAP3	ISDN Routing Map-3 Table
IBNMAP4	ISDN Routing Map-4 Table
IBNRTE	IBN Route Table
IBNRTE(AC)	Attendant Console (Selector AC) Subtable
IBNRTE(ARS)	Automatic Route Selection (Selector ARS) Subtable
IBNRTE(CFT)	Call Forward (Selector CFT) Subtable
IBNRTE(CND)	Calling Number Delivery (Selector CND) Subtable
IBNRTE(DN)	Delivery Number (Selector DN) Subtable
IBNRTE(EOW)	Enhanced WATS (Selector EOW) Subtable
IBNRTE(IBNRX)	IBN Route Reference Index (Selector IBNRX) Subtable
IBNRTE(INS)	Insert (Selector INS) Subtable
IBNRTE(ISA)	Integrated Service Access (Selector ISA) Subtable
IBNRTE(IW)	INWATS (Selector IW) Subtable
IBNRTE(LINE)	Line (Selector LINE) Subtable
IBNRTE(LOC)	Location (Selector LOC) Subtable
IBNRTE(N)	N (Selector N) Subtable
IBNRTE(NIL)	NIL (Selector NIL) Subtable
IBNRTE(NOT)	NOT (Selector NOT) Subtable
IBNRTE(OW)	OUTWATS (Selector OW) Subtable
IBNRTE(QH)	Queue Head (Selector QH) Subtable
IBNRTE(RX)	Retranslate (Selector RX) Subtable

Table 3-1 (Sheet 37 of 87)

Short name	Title
IBNRTE(S)	S (Selector S) Subtable
IBNRTE(SG)	Supergroup (Selector SG) Subtable
IBNRTE(T)	T (Selector T) Subtable
IBNRTE(TRMT)	Treatment (Selector TRMT) Subtable
IBNRTE(VFG)	Virtual Facility Group (Selector VFG) Subtable
IBNRT2	IBN Second Route Table
IBNRT3	IBN Third Route Table
IBNRT4	IBN Fourth Route Table
IBNSC	IBN Speed Calling List Table
IBNTREAT	IBN Treatment Table
IBNXLA	IBN Translation Table
IBNXLA(AIN)	Advanced Intelligent Network (Selector AIN) Subtable
IBNXLA(AMBI)	Ambiguous Code Dialing Version 1(Selector AMBI) Subtable
IBNXLA(AMBIG)	Ambiguous Code Dialing Version II (Selector AMBIG) Subtable
IBNXLA(ATT)	Attendant Access (Selector ATT) Subtable
IBNXLA(ATTO)	Access to Attendant in Other Customer Group (Selector ATTO) Subtable
IBNXLA(BC)	Bearer Capability (Selector BC) Subtable
IBNXLA(CUTTD)	Cut-through Dialing (Selector CUTTD) Subtable
IBNXLA(CWD)	Dial Call Waiting (Selector CWD) Subtable
IBNXLA(DOD)	Direct Outward Dial (Selector DOD) Subtable
IBNXLA(ESN)	Electronic Switched Network (Selector ESN) Subtable
IBNXLA(EXTN)	Extension Selector (Selector EXTN) Subtable
IBNXLA(FEAT)	Feature (Selector FEAT) Subtable
IBNXLA(FLEXI)	Route to IBN Treatment (Selector FLEXI) Subtable
IBNXLA(FTR)	Refineable Translation Result (Selector FTR) Subtable

Table 3-1 (Sheet 38 of 87)

Short name	Title
IBNXLA(GEN)	General Network Selector (Selector GEN) Subtable
IBNXLA(GIC)	Group Intercom (Selector GIC) Subtable
IBNXLA(IAG23)	Two or Three Digit Station Numbers (Selector IAG23) Subtable
IBNXLA(LOC)	Location (Selector LOC) Subtable
IBNXLA(LPACT)	Loudspeaker Paging Answerback Activation (Selector LPACT) Subtable
IBNXLA(LSPKP)	Loudspeaker (Selector LSPKP) Subtable
IBNXLA(MBG)	Multiswitch Business Group (Selector MBG) Subtable
IBNXLA(N)	Set Prefix Fence (Selector N) Subtable
IBNXLA(NET)	Networks (Selector NET) Subtable
IBNXLA(PROTO)	Electronic Switched Network Information Signals (Selector PROTO) Subtable
IBNXLA(PVT)	Private Network (Selector PVT) Subtable
IBNXLA(REPL)	(Selector REPL) Subtable
IBNXLA(ROUTE/L)	Digits Dialed to be Replaced (Selector ROUTE/L) Subtable
IBNXLA(ROUTE/S)	Route Directly to CLLI (Selector ROUTE/S) Subtable
IBNXLA(ROUTE/T)	Route to Office or IBN Route (Selector ROUTE/T) Subtable
IBNXLA(SFMT)	Switch Format (Selector SFMT) Subtable
IBNXLA(SLE)	Selective List Editing (Selector SLE) Subtable
IBNXLA(SPDC)	Speed Calling Access Code (Selector SPDC) Subtable
IBNXLA SRNG)	Station Ringer (Selector SRNG) Subtable
IBNXLA(STAR)	Star (Selector STAR) Subtable
IBNXLA(TRMT)	Route to Office, Line or Trunk Treatment (Selector TRMT) Subtable
IBNXLA(TTTR)	Tandem Tie to Trunk Route (Selector TTTR) Subtable
IBNXLA(TTTT)	Tandem Tie Trunk Termination (Selector TTTT) Subtable
IBNXLA(U3WC)	Three-way Calling Usage Sensitive (Selector U3WC) Subtable
IBNXLA(VMX)	Voice Message Exchange (Selector VMX) Subtable

Table 3-1 (Sheet 39 of 87)

Short name	Title
ICIDATA	Incoming Call Identification Data Table
ICNTRY	ITOPS International Country Inward Call and Directory Assistance Operator Table
IDBCLASS	ITOPS International Delay Call Database Keyed Values Table
IDIGCTL	Information Digits Control Table
IFC	Inbound Facility Table
IFORDA	ITOPS International Country-City Directory Assistance Operator Table
IFORINW	ITOPS International Country-City Inward Call Operator Table
ILPELGBL	OLNS Intra-LATA Presubscription Eligibility Table
ILPREGN	OLNS Intra-LATA Presubscription Region Number Table
IMAGEDEV	Image Device Table
IMGSCHEDE	Image Schedule Table
INATLPRT	International Pretranslator Names Table
INBGCUST	IN Business Group to Customer Group Mapping Table (MMP only)
INNCOS	Intelligent Network Class of Service Table (MMP only)
INPRTRNS	International Pretranslator Table
INTCCFMT	International Calling Card Format Table
INTCCMTR	International CC Metering Table
INTLZONE	International Zone Table (MMP only)
INWOMAP	INWATS Originating Map Table
INWORIBN	INWATS Originating Band Table
INWORICN	INWATS Originating Control Table
INWORIRT	INWATS Originating Route Reference Table
INWSNPA	INWATS Originating Screen Office Table
INWTERCN	INWATS Terminating Control Table
INWTERTE	INWATS Terminating Route Reference Table

Table 3-1 (Sheet 40 of 87)

Short name	Title
INWTMAP	INWATS Terminating Map Table
IOC	Input Output Controller Table
IOGTKEY	ITOPS OGT Key Table
IOPATTR	International Traffic Operator Position System Attributes Table
IOPRTRAN	ITOPS Operator Translations Table
IPCOMID	Internet Protocol Communications Identifier
IPEINV	Intelligent Peripheral Equipment Inventory Table
IPHOST	Internet Protocol SuperNode End Hosts Table
IPINV	Internet Protocol Inventory Table
IPMLINV	Interperipheral Message Link Inventory Table
IPNETWRK	Internet Protocol Network Table
IPROUTER	Internet Protocol Subnet Router Table
IPSCP	Internet Protocol to Service Control Point
IPSVCS	Internet Protocol Services
IPTHRON	Internet Protocol Throttling Numbers Table
IRLNKINV	Interlink Inventory Table
ISAINFO	In-session Activation Information Table
ISAMENU	In-session Activation Menu Table
ISAXLA	Integrated Services Access Translation Table
ISCTAB	International Service Calls Table
ISDNBILL	ISDN Services Billing Table
ISDNPARM	ISDN Trunk Subgroup Parameter Table
ISDNPROT	ISDN Protocol Variant Timer Table
ISDNTCP	ISDN Test Call Parameter Table
ISGDEF	ISDN Service Group Definition Table
ISGTDM	ISDN Service Group Time Division Multiplex Table

Table 3-1 (Sheet 41 of 87)

Short name	Title
ISNDPMAP	Intelligent Services Node Digit Pattern Mapping Table
SPIDGRP	Service Provider Identifier Group Table
ISTRKGRP	RCC Dynamic Trunk Groups Table
ISUPDEST	CCS7 ISDN User Part Destination Table
ISUPSERV	ISDN User Part Services Table
ISUPTRK	ISDN User Part Trunk Table
ITOPATTR	ITOPS Attributes Table
ITOPS	ITOPS Position Display Table
ITOPSANI	ANI to ITOPS by Service Class Table
ITOPSDEV	ITOPS Device Table
TOPSDP	TOPS Dial Plan Table
ITOPSERV	ITOPS Position Routing Table
ITOPSOPR	ITOPS Operator Table
ITOPSPOS	ITOPS Position Table
ITOPTRBL	ITOPS Operator Reporting Trouble Disposition Table
TQSPIDNM	TOPS Queue Management System Service Provider Identifier Name Table
IVDINV	Integrated Voice and Data Set Inventory Table
IVDTRBL	Integrated Voice And Data Trouble Table
IVPNCONV	International Virtual Private Network Conversion Table
KP2TRUNK	NSC KP2 Trunk Groups Table
KSETFEAT	Business Set and Data Unit Feature Table
KSETFEAT(3WC)	Three-way Calling (Feature 3WC) Subtable
KSETFEAT(3WC PUB)	Three-way Calling Public (Feature 3WC PUB) Subtable
KSETFEAT(AAB)	Auto Answerback (Feature AAB) Subtable
KSETFEAT(ACB)	Automatic Callback (Feature ACB) Subtable

Table 3-1 (Sheet 42 of 87)

Short name	Title
KSETFEAT(ACDNR)	Automatic Call Distribution Not Ready (Feature ACDNR) Subtable
KSETFEAT(ACOU)	Additional Call Offering - Unrestricted (Feature ACOU) Subtable
KSETFEAT(ACRJ)	Anonymous Caller Rejection (Feature ACRJ) Subtable
KSETFEAT(AFC)	Additional Functional Calls (Feature AFC) Subtable
KSETFEAT(AIN)	Advanced Intelligent Network (Feature AIN) Subtable
KSETFEAT(AOC)	Advice of Charge (Feature AOC) Subtable
KSETFEAT(AR)	Automatic Recall (Feature AR) Subtable
KSETFEAT(ASL)	Agent Status Lamp (Feature ASL) Subtable
KSETFEAT(ASP)	Alternate Service Provider (Feature ASP) Subtable
KSETFEAT(AUD)	Automatic Dial (Feature AUD) Subtable
KSETFEAT(AUL)	Automatic Dial (Feature AUL) Subtable
KSETFEAT(AUTODISP)	Automatic Display (Feature AUTODISP) Subtable
KSETFEAT(BBGI)	Basic Business Group ISDN (Feature BBGI) Subtable
KSETFEAT(BC)	Bearer Capability (Feature BC) Subtable
KSETFEAT(BCLID)	Bulk Calling Line Identification (Feature BCLID) Subtable
KSETFEAT(BLF)	Busy Lamp Field (Feature BLF) Subtable
KSETFEAT(CCV)	Call Covering (Feature CCV) Subtable
KSETFEAT(CCBS)	Call Completion to Busy Subscriber (Feature CCBS) Subtable
KSETFEAT(CFB)	Call Forward Busy (Feature CFB) Subtable
KSETFEAT(CFD)	Call Forward Don't Answer (Feature CFD) Subtable
KSETFEAT(CFDVT)	Call Forward Don't Answer Variable Timer (Feature CFDVT) Subtable
KSETFEAT(CFFPOVR)	Call Forward Fraud Prevention Override (Feature CFFPOVR) Subtable
KSETFEAT(CFTB)	Call Forward Timed for CFB (Feature CFTB) Subtable
KSETFEAT(CFTD)	Call Forward Timed for CFD (Feature CFTD) Subtable
KSETFEAT(CRUIF)	Call Forward Universal Intragroup Fixed (Feature CRUIF) Subtable

Table 3-1 (Sheet 43 of 87)

Short name	Title
KSETFEAT(CFX)	Call Forwarding (Feature CFX) Subtable
KSETFEAT(CFXDNCT)	Call Forwarding per DN per Call Type (Feature CFXDNCT) Subtable
KSETFEAT(CFXVAL)	Call Forwarding Validation (Feature CFXVAL) Subtable
KSETFEAT(CIDSDLV)	Caller ID Delivery and Suppression Delivery (Feature CIDSDLV) Subtable
KSETFEAT(CIDSSUP)	Caller ID Delivery and Suppression (Feature CIDSSUP) Subtable
KSETFEAT(CIF)	Controlled Interflow (Feature CIF) Subtable
KSETFEAT(CLI)	Calling Line Identification (Feature CLI) Subtable
KSETFEAT(CNF)	Flexible Station-controller Conference (Feature CNF) Subtable
KSETFEAT(COT)	Customer Originated Trace (Feature COT) Subtable
KSETFEAT(CPR)	Datapath Call Path Restoration (Feature CPR) Subtable
KSETFEAT(CPU)	Call Pickup (Feature CPU) Subtable
KSETFEAT(CRBL)	Call Reference Busy Limit (Feature CRBL) Subtable
KSETFEAT(CSMI)	Call Screening, Monitoring and Intercept (Feature CSMI) Subtable
KSETFEAT(CTD)	Carrier Toll Denied (Feature CTD) Subtable
KSETFEAT(CUG)	Closed User Group (Feature CUG) Subtable
KSETFEAT(CW)	Call Waiting (Feature CW) Subtable
KSETFEAT(CWD)	Dial Call Waiting (Feature CWD) Subtable
KSETFEAT(CWT)	Call Waiting (Feature CWT) Subtable
KSETFEAT(CXR)	Call Transfer (Feature CXR) Subtable
KSETFEAT(DASK)	Display Agent Status Key (Feature DASK) Subtable
KSETFEAT(DBC)	Call Reference Busy Limit (Feature DBC) Subtable
KSETFEAT(DCC)	Deactivate Conference Facility (Feature DCC) Subtable
KSETFEAT(DCPK)	Directed Call Park (Feature DCPK) Subtable
KSETFEAT(DDI)	Direct Dialing In (Feature DDI) Subtable
KSETFEAT(DIN)	Denied Incoming (Feature DIN) Subtable

Table 3-1 (Sheet 44 of 87)

Short name	Title
KSETFEAT(DMCT)	Deny Malicious Call Termination (Feature DMCT) Subtable
KSETFEAT(DND)	Do Not Disturb (Feature DND) Subtable
KSETFEAT(DQS)	Display Queue Status (Feature DQS) Subtable
KSETFEAT(DQT)	Display Queue Threshold (Feature DQT) Subtable
KSETFEAT(DRING)	Distinctive Ringing (Feature DRING) Subtable
KSETFEAT(DROP)	Drop (Feature DROP) Subtable
KSETFEAT(EBO)	Executive Busy Override (Feature EBO) Subtable
KSETFEAT(ECM)	Extended Call Management (Feature ECM) Subtable
KSETFEAT(EMK)	Emergency Key (Feature EMK) Subtable
KSETFEAT(EMW)	Executive Message Waiting (Feature EMW) Subtable
KSETFEAT(FAA)	Forced Agent Availability (Feature FAA) Subtable
KSETFEAT(FC)	Flexible Calling (Feature FC) Subtable
KSETFEAT(FCTDINT)	Full Carrier Toll Deny for International Carriers (Feature FCTDINT) Subtable
KSETFEAT(FXR)	Fast Transfer (Feature FXR) Subtable
KSETFEAT(GIAC)	Group Intercom All Call (Feature GIAC) Subtable
KSETFEAT(HF, HFMUTE, MUTE, SOFTKEY)	Hands-free Control (Feature HF, HFMUTE, MUTE, SOFTKEY) Subtable
KSETFEAT(ICM)	Intercom (Feature ICM) Subtable
KSETFEAT(INSPECT)	Inspect (Feature INSPECT) Subtable
KSETFEAT(ISA)	In-session Activation (Feature ISA) Subtable
KSETFEAT(JOIN)	Conference Join (Feature JOIN) Subtable
KSETFEAT(KSH)	Key Short Hunt (Feature KSH) Subtable
KSETFEAT(LMOH)	Line Music on Hold (Feature LMOH) Subtable
KSETFEAT(LOB)	Line of Business Code (Feature LOB) Subtable
KSETFEAT(LOCAL)	Local (Feature LOCAL) Subtable
KSETFEAT(LPIC)	Primary Intra-LATA Carrier (Feature LPIC) Subtable

Table 3-1 (Sheet 45 of 87)

Short name	Title
KSETFEAT(LSPSO)	Local Service Provider Switch Owner (Feature LSPSO) Subtable
KSETFEAT(LVM)	Leave Message (Feature LVM) Subtable
KSETFEAT(MBSCAMP)	Meridian Business Set Camp-on (Feature MBSCAMP) Subtable
KSETFEAT(MCH)	Malicious Call Hold (Feature MCH) Subtable
KSETFEAT(MCI)	Malicious Call ID (Feature MCI) Subtable
KSETFEAT(MIPHONE)	Medicated Individual Telephony (Feature MIPHONE) Subtable
KSETFEAT(MRFM)	Multiple Appearance Directory Number Ring Forward Manual (Feature MRFM) Subtable
KSETFEAT(MSB)	Make Set Busy (Feature MSB) Subtable
KSETFEAT(MWIDC)	Message Waiting Indication (Feature MWIDC) Subtable
KSETFEAT(MWQRY)	Message Waiting Query (Feature MWQRY) Subtable
KSETFEAT(MWT)	Message Waiting (Feature MWT) Subtable
KSETFEAT(NDNAP)	Number of DN Appearances (Feature NDNAP) Subtable
KSETFEAT(NGTSRVCE)	Night Service (Feature NGTSRVCE) Subtable
KSETFEAT(NRS)	Network Resource Selector (Feature NRS) Subtable
KSETFEAT(OBS)	Observe Agent (Feature OBS) Subtable
KSETFEAT(OLS)	Originating Line Select (Feature OLS) Subtable
KSETFEAT(PBL)	Private Business Line (Feature PBL) Subtable
KSETFEAT(PCACIDS)	Privacy Change Allowed Caller ID Delivery and Suppression (Feature PCACIDS) Subtable
KSETFEAT(PF)	Power Feature (Feature PF) Subtable
KSETFEAT(PIC)	Primary Inter-LATA Carrier (Feature PIC) Subtable
KSETFEAT(PRK)	Call Park (Feature PRK) Subtable
KSETFEAT(PRL)	Privacy Release (Feature PRL) Subtable
KSETFEAT(PRV)	Privacy (Feature PRV) Subtable
KSETFEAT(QBS)	Query Busy Station (Feature QBS) Subtable
KSETFEAT(QCK)	Quick Conference Key (Feature QCK) Subtable

Table 3-1 (Sheet 46 of 87)

Short name	Title
KSETFEAT(QTD)	Query Time and Date (Feature QTD) Subtable
KSETFEAT(RAG)	Ring Again (Feature RAG) Subtable
KSETFEAT(RMB)	Random Make Busy (Feature RMB) Subtable
KSETFEAT(RSUS)	Requested Suspension (Feature RSUS) Subtable
KSETFEAT(SACB)	Subscriber Activated Call Blocking (Feature SACB) Subtable
KSETFEAT(SCF)	Selective Call Forwarding (Feature SCF) Subtable
KSETFEAT(SCL)	Speed Calling Long List (Feature SCL) Subtable
KSETFEAT(SCS)	Speed Calling Short List (Feature SCS) Subtable
KSETFEAT(SDY)	AT&T line Study (Feature SDY) Subtable
KSETFEAT(SEC)	Security Code (Feature SEC) Subtable
KSETFEAT(SHU)	Stop Hunt (Feature SHU) Subtable
KSETFEAT(SimRing)	Simultaneous Ringing (Feature SimRing) Subtable
KSETFEAT(SLQ)	Single Line Queue (Feature SLQ) Subtable
KSETFEAT(SLU)	Subscribers Line Usage (Feature SLU) Subtable
KSETFEAT(SMDI)	Station Message Desk Interface (Feature SMDI) Subtable
KSETFEAT(SOR)	Station Origination Restrictions (Feature SOR) Subtable
KSETFEAT(SPB)	Special Billing Code (Feature SPB) Subtable
KSETFEAT(SSAC)	Station Specific Authcode (Feature SSAC) Subtable
KSETFEAT(SUPR)	Supervisor (Feature SUPR) Subtable
KSETFEAT(TBO)	Terminating Billing Option (Feature TBO) Subtable
KSETFEAT(TLS)	Terminating Line Select (Feature TLS) Subtable
KSETFEAT(TRANSFER)	Call Transfer ISDN (Feature TRANSFER) Subtable
KSETFEAT(TRKDISP)	Trunk Member Display (Feature TRKDISP) Subtable
KSETFEAT(UCDLG)	Uniform Call Distribution Login (Feature UCDLG) Subtable
KSETFEAT(UCDSD)	Uniform Call Distribution Signal Distribution Point (Feature UCDSD) Subtable

Table 3-1 (Sheet 47 of 87)

Short name	Title
KSETFEAT(VMEADENY)	Voice Mail Easy Access Deny (Feature VMEADENY) Subtable
KSETFEAT(VMEADN)	Voice Mail Easy Access Directory Number (Feature VMEADN) Subtable
KSETFEAT(WML)	Warm Line (Feature WML) Subtable
KSETFEAT(WUCR)	Wake-up Call (Feature WUCR) Subtable
KSETFEAT(XFER)	Call Transfer ISDN (Feature XFER) Subtable
KSETFEAT(XXTRG)	XX Trigger (Feature XXTRG) Subtable
KSETINV	Business Set and Data Unit Inventory Table
KSETKEYS	Business Set Feature Keys Table
KSETLINE	Business Set and Data Unit Line Assignment Table
KSETQCK	Business Set and Data Unit Quick Conference Key Table
KTGROUP	Killer Trunk Group Table
KTMINMAX	Killer Trunk Minimum Maximum Table
KTPARMS	Killer Trunk Parameters Table
L2ABNLOG	Layer 2 Abnormality Log Table
L3ABNLOG	Layer 3 Abnormality Log Table
LAC	Location Area Code Table
LAMABC	Local Automatic Message Accounting Billing Code Table
LANGTOQ	Language-to-TOPS Call Queue Routing Table
LATANAME	Equal Access Local Access and Transport Area Name Table
LATAOLA	Equal Access Local Access and Transport Area Translation Table
LATTRDR	LINEATTR Dump and Restore Table
LCA6SCRN	Local Calling Area 6 Screen Table
LCAINFO	Local Calling Area Information Table
LCARNAME	Local Calling Area Name Table
LCARSCRN	Local Calling Area Screening Table

Table 3-1 (Sheet 48 of 87)

Short name	Title
LCASCRCN	Local Calling Area Screening Control Table
LCASCRCN.LCASCRCN	Local Calling Area Screening Subtable
LCCOPT	Line Class Code Compatible Options Table
LCLRS	TOPS Calling Tariff to Local Rate Step Table
LCLRSI	TOPS Calling Tariff to Local Rate Step Inactive Table
LCMDRINV	Line Concentration Module Drawer Inventory Table
LCMINV	Line Concentrating Module Inventory Table
LDASCRN	Long Distance Alerting Screening Table (MMP only)
LDTINV	Line Appearance on a Digital Trunk Inventory Table
LENFEAT	Line Feature Table
LENFEAT(ADL)	Abbreviated Dialing (Feature ADL) Subtable
LENFEAT(AIN)	Advanced Intelligent Network (Feature AIN) Subtable
LENFEAT(AIOD)	Auto-identified Outward Dialing (Feature AIOD) Subtable
LENFEAT(AUL)	Automatic Line (Feature AUL) Subtable
LENFEAT(BCLID)	Bulk Calling Line Identification (Feature BCLID) Subtable
LENFEAT(CDA)	Call Diversion (Feature CDA) Subtable
LENFEAT(CFFPOVR)	Call Forward Fraud Prevention Override (Feature CFFPOVR) Subtable
LENFEAT(CLI)	Calling Line Identification (Feature CLI) Subtable
LENFEAT(CSDDS)	Circuit Switched Digital Data Service (Feature CSDDS) Subtable
LENFEAT(CTD)	Carrier Toll Denied (Feature CTD) Subtable
LENFEAT(ESG)	Emergency Service Group (Feature ESG) Subtable
LENFEAT(ESL)	Emergency Service with Ringdown Trunk (Feature ESL) Subtable
LENFEAT(EWAL)	Enhanced WATS Access Line (Feature EWAL) Subtable
LENFEAT(FCTDINT)	Full Carrier Toll Deny for International Carriers (Feature FCTDINT) Subtable
LENFEAT(FRO)	Sleeve Lead Control (Feature FRO) Subtable

Table 3-1 (Sheet 49 of 87)

Short name	Title
LENFEAT(FRS)	Sleeve Lead for Public Fire Reporting System (Feature FRS) Subtable
LENFEAT(HTL)	Hot Line (Feature HTL) Subtable
LENFEAT(IDND)	International Do Not Disturb (Feature IDND) Subtable
LENFEAT(ILR)	International Line Restrictions (Feature ILR) Subtable
LENFEAT(INDC)	International No Double Connect (Feature INDC) Subtable
LENFEAT(LPIC)	Local Primary Intra-LATA Carrier (Feature LPIC) Subtable
LENFEAT(LSPSO)	Local Service Provider Switch Owner (Feature LSPSO) Subtable
LENFEAT(MBK)	Make Busy Key (Feature MBK) Subtable
LENFEAT(MPB)	Multiparty Bridge (Feature MPB) Subtable
LENFEAT(OUTWT)	OUTWATS (Feature OUTWT) Subtable
LENFEAT(PIC)	Primary Inter-LATA Carrier (Feature PIC) Subtable
LENFEAT(RMB)	Random Make Busy (Feature RMB) Subtable
LENFEAT(RMP)	Remote Meter Pulsing (Feature RMP) Subtable
LENFEAT(RMS)	Remote Register Signal Distributor Point (Feature RMS) Subtable
LENFEAT(RSUS)	Requested Suspension (Feature RSUS) Subtable
LENFEAT(SC1)	Speed Calling Short List (Feature SC1) Subtable
LENFEAT(SC2)	Speed Calling Long List (Feature SC2) Subtable
LENFEAT(SCMP)	Series Completion (Feature SCMP) Subtable
LENFEAT(SDN)	Secondary Directory Number (Feature SDN) Subtable
LENFEAT(SDY)	AT&T Line Studies (Feature SDY) Subtable
LENFEAT(SHU)	Stop Hunt (Feature SHU) Subtable
LENFEAT(SLU)	Subscribers Line Usage (Feature SLU) Subtable
LENFEAT(SPB)	Special Billing Code (Feature SPB) Subtable
LENFEAT(TBO)	Terminating Billing Option (Feature TBO) Subtable
LENFEAT(WLN)	Warm Line (Feature WLN) Subtable
LENLINES	Line Assignment Table

Table 3-1 (Sheet 50 of 87)

Short name	Title
LGINCTRL	Login Control Table
LIMCDINV	Link Interface Module Card Inventory Table
LIMINV	Link Interface Module Inventory Table
LIMPTINV	Link Interface Module Port Inventory Table
LINEATTR	Line Attribute Table
LIUINV	Link Interface Unit Inventory Table
LKIDTAB	Link Identifier Table
LMINV	Line Module Inventory Table
LMOVCODE	Line-to-Trunk Overlap Outpulse Table
LMRNG	Line Module Ring Code Table
LNADMIN	Line Administration Table
LNBVN	Line Balance Network Value Table
LNCODE	TOPS Line Number Method of Coin Control Table
LNNETWORK	Logical Metering Networks Table
LNINV	Line Circuit Inventory Table
LNINVEST	Line Inventory Extension Table
LNMPEOC	Line Multipoint Embedded Operations Channel Table
LNMTRNAM	Line Meter Names Table
LNPCODE	Local Number Portability Code Table
LNPOPTS	Local Number Portability Options Table
LNPRTE	Local Number Portability Route Table
LNSIGSYS	Line Signaling System Table
LNSIGSYS(DELDIAL)	Signaling Type DELDIAL Subtable
LNSIGSYS(N5)	Signaling Type N5 Subtable
LNSIGSYS(NTLS03)	Signaling Type NTLS03 Subtable
LNSIGSYS(NTLS04)	Signaling Type NTLS04 Subtable

Table 3-1 (Sheet 51 of 87)

Short name	Title
LNSIGSYS(NTLS05)	Signaling Type NTLS05 Subtable
LNSIGSYS(NTLS06 incoming)	Signaling Type NTLS06 Incoming Subtable
LNSIGSYS(NTLS06 outgoing)	Signaling Type NTLS06 Outgoing Subtable
LNSIGSYS(NTLS07 incoming)	Signaling Type NTLS07 Incoming Subtable
LNSIGSYS(NTLS07 outgoing)	Signaling Type NTLS07 Outgoing Subtable
LNSIGSYS(NTLS08 incoming)	Signaling Type NTLS08 Incoming Subtable
LNSIGSYS(NTLS08 outgoing)	Signaling Type NTLS08 Outgoing Subtable
LNSIGSYS(NTLS09 incoming)	Signaling Type NTLS09 Incoming Subtable
LNSIGSYS(NTLS09 outgoing)	Signaling Type NTLS09 Outgoing Subtable
LNSIGSYS(NTLS10)	Signaling Type NTLS10 Subtable
LNSIGSYS(NTLS11 incoming)	Signaling Type NTLS11 Incoming Subtable
LNSIGSYS(NTLS11 outgoing)	Signaling Type NTLS11 Outgoing Subtable
LNSIGSYS(NTLS14)	Signaling Type NTLS14 Subtable
LNSIGSYS(NTLS15 incoming)	Signaling Type NTLS15 Incoming Subtable
LNSIGSYS(NTLS15 outgoing)	Signaling Type NTLS15 Outgoing Subtable
LNSIGSYS(NTLS16 incoming)	Signaling Type NTLS16 Incoming Subtable
LNSIGSYS(NTLS16 outgoing)	Signaling Type NTLS16 Outgoing Subtable

Table 3-1 (Sheet 52 of 87)

Short name	Title
LNSIGSYS(NTLS16 two-way)	Signaling Type NTLS16 Two-Way Subtable
LNSIGSYS(NTLS20 incoming)	Signaling Type NTLS20 Incoming Subtable
LNSIGSYS(NTLS20 outgoing)	Signaling Type NTLS20 Outgoing Subtable
LNSIGSYS(NTLS22 incoming)	Signaling Type NTLS22 Incoming Subtable
LNSIGSYS(NTLS22 outgoing)	Signaling Type NTLS22 Outgoing Subtable
LNSIGSYS(NTLS24 incoming/outgoing)	Signaling Type NTLS24 Incoming/Outgoing Subtable
LNSIGSYS(WINKSIG)	Signaling Type WINKSIG Subtable
LNSMTCE	Line Maintenance Table
LNTDM	Line Time Division Multiplex Table
LNTHRSH	Lines and Thresholds Management Table
LOGCLASS	Log Class Table
LOGDEV	Log Device Table
LOGINFO	Log Control Information Table
LPBKMEM	Loopback Trunk Member Table
LSCFLAGS	Line Screening Code Flag Table
LSPINFO	Local Service Provider Information Table
LTCALLS	Logical Terminal Calls Table
LTCINV	Line Trunk Controller Inventory Table
LTCPSINV	Line Trunk Controller P-Side Link Inventory Table
LTCRINV	Line Trunk Controller Remote Inventory Table
LTCRPINV	Line Trunk Controller Remote P-Side Link Inventory Table
LTDATA	Logical Terminal Data Table

Table 3-1 (Sheet 53 of 87)

Short name	Title
LTDEF	Logical Terminal Definition Table
LTDSB	Line Test Desk Signal Distribution Table
LTGRP	Logical Terminal Group Table
LTMAP	Logical Terminal Mapping Table
LTPAUX	Line Test Position Auxiliary Commands Table
LTPDEF	Line Test Position Default Commands Table
MCCSNBEC	Mechanized Calling Card Service Non Bell Exchange Carrier Table
MCCSOST	TOPS Mechanized Calling Card Service Originating Station Treatment Table
MDESTIDX	Metering Destination Index Table
MDNGRP	Multiple Appearance Directory Number Group Table
MDNMEM	Multiple Appearance Directory Number Member Table
MDSACTN	TOPS Message Delivery System Actions Table
MDSLNG	TOPS Message Delivery System Language Table
MDSOPT	TOPS Message Delivery Service Options Table
MFCACT	Multifrequency Compelled Signal to Activity Translation Table
MFCPROT	Multifrequency Compelled Protocol Tuples List Table
MFCTRTMT	MFC Activity to Extended Treatment Translation Table
MILES	TOPS Mileage Table
MILESI	TOPS Mileage Inactive Table
MINCHG	TOPS Minimum Charge Table
MINCHGI	TOPS Minimum Charge Inactive Table
MLCCOPT	Mobile Line Class Code Compatible Table
MMA0-9	Minimum, Maximum Digits, and Ambiguous Code Table
MMCONF	IBN Meet-Me Conference Table
MNETATTR	Metering Network Attributes Table

Table 3-1 (Sheet 54 of 87)

Short name	Title
MOBCENT	Mobile Centrex Provisioning Table
MODEMPRO	Modem Protocol Name Definition Table
MODMAP	ITOPS Rating Charge Calculator Day Charge Modification Map Table
MODSET	ITOPS Rating Charge Calculator Time Charge Modification Set Table
MOPTOPT	Mobile Incompatible Options Table
MPBINV	Multiparty Bridge Inventory Table
MPC	Multiprotocol Controller Table
MPCFASTA	Multiprotocol Controller Fast Applications Table
MPCLINK	Multiprotocol Controller Link Table
MPCLOGIN	Multiprotocol Controller Login Table
MPCLSET	Multiprotocol Controller Linkset Table
MPHCON	Multiple Position Hunt Console Table
MPHGRP	Multiple Position Hunt Group Table
MQLIMITS	Maintenance Q Limits Table
MRSANAME	List of Multiunit Message Rate Area Names Table
MSBINV	Message Switching Buffer Inventory Table
MSBPSINV	Message Switching Buffer P-Side Inventory Table
MSCDINV	Message Switch Cards Inventory Table
MSRCDATA	Metering Source Data Table
MSFWLOAD	Message Switch Firmware Load Table
MSGRTE	PRA Facility Message Routing Table
MSILINV	Message Switch Inter-MS Link Inventory Table
MSINV	Message Switch Inventory Table
MTAHORIZ	Metallic Test Access Horizontal Connection Table
MTAMDRVE	Metallic Test Access Minibar Driver Table
MTARFIDX	Metering Tariff Index Table

Table 3-1 (Sheet 55 of 87)

Short name	Title
MTARFNUM	Metering Tariff Number Table
MTARIFF	Metering Tariff Table
MTAVERT	Metallic Test Access Vertical Connection Table
MTCFAIL	Maintenance Failure Messages Table
MTCTEST	Maintenance Failure Messages Table
MTD	Magnetic Tape Device Table
MTSIGSYS	Hardware Metering for Trunks Signaling System Table
MTRLNET	Metering Logical Networks Table (MMP only)
MTRLMOG	Metered Originator Groups Table (MMP only)
MTRMOTS	Metered Originator Tariff Sets Table (MMP only)
MTRNAMES	Meter Names Table (MMP only)
MTRNETIF	Metering Network Dependent Information Table (MMP only)
MTRSYSPM	Metering System Parameters Table (MMP only)
MTRTARIF	Metering Tariffs Table (MMP only)
MTRTTS	Metering Time-and-Date Tariff Sets Table (MMP only)
MUMRMBI	Multiunit Message Rate Message Billing Index Table
MUMRTAB	Multiunit Message Rate Screening Table
MWDATA	Milliwatt Data Table
N7CLLDGT	N7 (CCITT No.7) Called Global Title Table
N7CLLGGT	N7 (CCITT No.7) Calling Global Title Table
NACDGRP	Network Automatic Call Distribution Group Table
NARDATA	Network Access Registers Data Table
NATDGTAN	National Digit Analyser Table
NBECCODE	Non-Bell Exchange Company Code Table
NCOS	Network Class of Service Table
NCSADDR	Network Control System Address Table

Table 3-1 (Sheet 56 of 87)

Short name	Title
NCSAPPL	Network Control System Application Table
NETATTR	Network Attributes Table
NETJUNCT	Network Junction Group Table
NETNAMES	Internal Logical Network Names Table
NETTOPRT	NETINFO to Partition Number Mapping Table
NETTOSTS	Network Information Table
NETWORK	Network Assignment Table
NIUINV	Network Interface Unit Inventory Table
NLUPCLLI	Nailed-Up Connection CLLI Table
NMSDATA	Network Message Service Data Table
NNASST	Node Number Assignment Table
NO6BDXLA	CCITT No.6 Band Translation Table
NO6LINKS	CCITT No.6 Signaling Links Table
NO6LKSET	CCITT No.6 Link Set Table
NO6RTSET	CCITT No.6 Route Set Table
NO6STP	CCITT No.6 Signal Transfer Point Table
NO6STPBD	CCITT No.6 Signal Transfer Point Table
NO6TKMEM	CCITT No.6 Trunk Member Table
NOPADDR	Network Operations Protocol Address Table
NOPAPPLN	Network Operations Protocol Applications Table
NOPDEST	Network Operations Protocol Destination Table
NOPUSERS	Network Operations Protocol Users Table
NPACAT	Serving NPA Category Digit Table
NPACHECK	TOPS NPA Check Table
NPASPLIT	Numbering Plan Area Split Management Table
NPDIGMAP	Number Portability Digit Mapping Table

Table 3-1 (Sheet 57 of 87)

Short name	Title
NPENDING	Number Pending Table
NPRESERV	Number Pooling Reserved Number Marketing Table
NSCANNNS	Number Service Code Announcement Table
NSCCARR	Number Service Code 800 Plus Southbound Carrier ID Validation Table
NSCCODE	Number Service Code Table
NSCDEFS	Number Service Code Database Response Timeouts Table
NSCHEAD	Number Service Code Head Table
NSCRTE	Number Service Code Route Table
NSCSCRN	Number Service Code Screening Table
NSCSNPA	Number Service Code Special Area Codes Table
NSIMAP	Non Specified Information String Map Table (MMP only)
NSTAFAS	Night Service Trunk Answer from Any Station Table
NTCLANGS	Notification of Time and Charge Languages Table
NUMBFMT	ITOPS Position Display Number Formatting Table
NUMDIGS	Number of Digits Table (MMP only)
NWMAOCR	Network Management Automatic Out of Chain Reroute Table
NWMCLLI	Network Management CLLI Table
NWMIDOC	Network Management Internal Dynamic Overload Control Table
NWMPPLN	Network Management Preplan Control Table
NWMSC	Network Management Scan Group Table
NWMSCPT	Network Management Scan Point Table
NWMSD	Network Management Signal Distributor Group Table
NWMSDPT	Network Management Signal Distributor Point Table
NX64MEM	NX64 Member Table
OACAUPRF	Operator Services Systems Advanced Intelligent Network (OSSAIN) Cause Profile Table

Table 3-1 (Sheet 58 of 87)

Short name	Title
OACNNPRF	Operator Services Systems Advanced Intelligent Network (OSSAIN) Connecting Profile Table
OACTLDEF	Control List Definition Table
OADSCRPF	Operator Services Systems Advanced Intelligent Network OSSAIN Post Disconnect Profile Table
OADTFPRF	Operator Services Systems Advanced Intelligent Network (OSSAIN) Dual Tone Multifrequency Profile Table
OAFUNBLK	Operator Services Systems Advanced Intelligent Network OSSAIN Function Blocking Table
OAFUNDEF	Operator Services Systems Advanced Intelligent Network OSSAIN Function Definition Table
OAFNDISP	Operator Services Systems Advanced Intelligent Network (OSSAIN) Function Disposition Table
OAINCTLA	Operator Services Systems Advanced Intelligent Network (OSSAIN) Control List Assignment Table
OAINPARM	Operator Services Systems Advanced Intelligent Network (OSSAIN) Parameters Table
OAINPRE	Operator Services Systems Advanced Intelligent Network (OSSAIN) Preprocessing Table
OAINRTE	Operator Services Systems Advanced Intelligent Network (OSSAIN) Route
OANODINV	Operator Services Systems Advanced Intelligent Network (OSSAIN) Node Inventory Table
OANODNAM	Operator Services Systems Advanced Intelligent Network (OSSAIN) Node Name Table
OATLKPRF	Operator Services Systems Advanced Intelligent Network (OSSAIN) Talking Profile Table
OATPREFIX	Operator Services Systems Advanced Intelligent Network (OSSAIN) Trigger Profile Table
OASESNPL	Operator Services Systems Advanced Intelligent Network (OSSAIN) Session Pool Table

Table 3-1 (Sheet 59 of 87)

Short name	Title
OAVLMAP	Operator Services Systems Advanced Intelligent Network (OSSAIN) Node Inventory Table
OCCINFO	Equal Access Other Common Carrier Information Table
OCCMAP	Equal Access List of Other Common Carrier Mapping Table
OCCNAME	Equal Access List of Other Common Carrier Names Table
OCCRDIG	Equal Access Other Common Carrier R-Digit Table
OCCSRV	Equal Access Other Common Carrier Service Data Table
OCCTSINT	Equal Access Other Common Carrier Traffic Separation Intersection Table
OCDLGRP	Operator Centralization Data Link Group Table
OCGRP	Operator Centralization Group Table
OCHOST	Operator Centralization Host Table
OCHOSTQ	Operator Centralization Host Queue Table
OCIPDL	Operator Centralization Internet Protocol Map
OCOFC	Operator Centralization Office Table
OCPARMS	Operator Centralization Parameter Table
OFC	Outbound Facility Table
OFCAUT	Office Autoprovisioning Table
OFCCODE	Office Code Table
OFCHEAD	Office Code Head Table
OFCRTE	Office Code Route Table
OFRT	Office Route Table
OFRT(AFR)	Automatic Flexible Routing (Selector AFR) Subtable
OFRT(CND)	Calling Number Delivery (Selector CND) Subtable
OFRT(DCRT)	Dynamically Controlled Routing (Selector DCRT) Subtable
OFRT(DN)	Directory Number (Selector DN) Subtable
OFRT(ISA)	Integrated Service Access (Selector ISA) Subtable

Table 3-1 (Sheet 60 of 87)

Short name	Title
OFRT(MEM)	Trunk Group Member (Selector MEM) Subtable
OFRT(MN)	Route Selector MN (Selector MN) Subtable
OFRT(N)	Route Selector N (Selector N) Subtable
OFRT(N2)	Route Selector N2 (Selector N2) Subtable
OFRT(NODE)	Route Selector NODE (Selector NODE) Subtable
OFRT(NOT)	Route Selector NOT (Selector NOT) Subtable
OFRT(NPOS)	Route Selector NPOS (Selector NPOS) Subtable
OFRT(NPOSDN)	Route Selector NPOS (Selector NPOSDN) Subtable
OFRT(QH)	Queue Head (Selector QH) Subtable
OFRT(RT)	Retranslate (Selector RT) Subtable
OFRT(RX)	Retranslate IBN (Selector RX) Subtable
OFRT(S)	Route Selector S (Selector S) Subtable
OFRT(SG)	Super Trunk Group (Selector SG) Subtable
OFRT(ST)	Same Subtable (Selector ST) Subtable
OFRT(SX)	Route Selector S (Selector SX) Subtable
OFRT(T)	Route Selector T (Selector T) Subtable
OFRT(TC)	Route Selector T (Selector TC) Subtable
OFRT(TPBX)	Route Selector TPBX (Selector TPBX) Subtable
OFRT(TRMT)	Treatment (Selector TRMT) Subtable
OFRT(TS)	Two-stage (Selector TS) Subtable
OFRT(UOP)	Uniform Outpulsing (Selector UOP) Subtable
OFR2	Office Route-2 Table
OFR3	Office Route-3 Table
OFR4	Office Route-4 Table
OFCTIID	Office Trigger Item identifier Table
OFRTMAP	ISDN OFRT Route Reference Table

Table 3-1 (Sheet 61 of 87)

Short name	Title
OFRTMA2	ISDN OFR2 Route Reference Table
OFRTMA3	ISDN OFR3 Route Reference Table
OFRTMA4	ISDN OFR4 Route Reference Table
OGTMPKEY	Outgoing Trunk Multipurpose Key Table
OGTSPKEY	Outgoing Trunk Single Purpose Key Table
OHBTADMIN	Off-Hook Balance Testing Administration Table
OHBTINV	Off-Hook Balance Testing Inventory Table
OHIP	Office Hardware Inventory Package Table
OHIPBULK	Bulk Hardware Inventory Package Table
OIASTART	Open Information Access Automatic Session Start Table
OICBC	Office Identification Code Billing Code Table
OLNSDARS	OLNS Directory Assistance Billing Restriction Table
OLNSDFLT	OLNS Default Table
OLNSEQDP	OLNS Service/Equipment Display Table
OLNSERR	OLNS Error Table
OLNSLANG	OLNS Language
OLNSRSDP	OLNS Originating Line Number Screening Restricted Billing Display Table
OLNSTARS	OLNS Toll and Assist Billing Restriction Table
OMACC	Operational Measurements Accumulator Table
OMACCESS	Operational Measurements Group Access Table
OMACCFLD	Operational Measurements Accumulator Field Table
OMACCGRP	Operational Measurements Accumulator Groups Table
OMACCKEY	Operational Measurements Accumulator Key Table
OMACCTOT	Operational Measurements Accumulator Total Table
OMDEV	Operational Measurements Device Table

Table 3-1 (Sheet 62 of 87)

Short name	Title
OMGRPORD	Operational Measurements Group Order Table
OMPRT	Operational Measurements Printer Table
OMREPORT	Operational Measurements Report Table
OMTAPE	Operational Measurements Output Recording Table
OMTHRESH	Threshold Alarms Table
OMTOTAL	Operational Measurements Totaling Table
OOCBILL	OOC Overseas Billing Restrictions Table
OPENANI	Open Numbering Plan ANI Table
OPMINV	Outside Plant Module Inventory Table
OPRCMLPX	Table Operator Complex and Unit ID Table
OPRDAT	TOPS Operator Data Table
OPRINFO	Operator Information Table
OPRPRFX	ITOPS Operator Automatic Prefixing Table
OPRTRANS	TOPS Operator Translations Table
OPTCTL	Option Control Table
OPTOPT	Incompatible Options Table
OPTTREAT	Optional Treatment Table
OQCQPROF	OSSAIN QMS Call Queue Profile Table
ORIGRC	TOPS Point-to-Point Rating Originating Rate Centers Table
OSCVLGRP	Operator Services Systems Advanced Intelligent Network (OSSAIN) Centralization Voice Link Group Table
OSIPARMS	Open Systems Interconnect Parameter Table
OSIRROUTE	Open Systems Interconnect Routing Table
OSNCCAP	Operator Services Network Capability
OSSANNS	Operator Services System Announcements Table
OSSCAT	ANIID Mapping for TOPS Trunk Groups with OSS Table

Table 3-1 (Sheet 63 of 87)

Short name	Title
OSSPROV	Operation System Support Provisioning Table
OVNTRNSL	Overseas Number Translation Table
OVR0-9	Overseas Route Tables
OVRMAP	Overseas Route Index Mapping Table
OVSBILL	TOPS Overseas Billing Restrictions Table
OVSCC	TOPS Overseas Credit Card Table
OVSCCYL	TOPS Overseas Credit Card Year Letter Table
OVSRS	TOPS Overseas Rate Step Table
OVSRSI	TOPS Overseas Rate Step Inactive Table
OWATZONE	OUTWATS Zone Table
OWNER	Owner Table
OWNTAB	Ownership Table
PACMAN	IBN ESN Protocol Analysis And Code Manipulation Table
PADDATA	Pad Data Table
PADNDEV	Patch Administration Device Table
PARSDENY	TOPS Personal Audio Response System Denial Table
PARSMBR	TOPS Personal Audio Response System Member Table
PATALARM	Patch Alarm Table
PATCHOPT	Patcher Options Table
PATCTRL	Patch Control Table
PATNS	Patch Nodeset Table
PATSET	Patch Set Table
PCIC	Phantom Carrier Identification Code Table
PCITRK	Preselect Carrier Identification Trunk Table (MMP only)
PCIXLA	Preselect Carrier Identification Translation Table (MMP only)
PECINV	Product Engineering Code Inventory Table

Table 3-1 (Sheet 64 of 87)

Short name	Title
PFCTRL	Power Feature Control Table
PFXTREAT	Prefix Treatment Table
PHDS1	Packet Handler to DS-1 Connection Table
PHINFO	Packet Handler Information Table
PHINV	Packet Handler Inventory Table
PICNAME	Primary Inter-LATA Carrier Name Table
PILOTGRP	Pilot Groups Table
PINDATA	Personal Identification Number Data Table
PLATAB	Physical Link Adapter Table
PMEXCEPT	Peripheral Modules Excepted Table
PMLOADS	Peripheral Module Loads Table
PMNODES	Peripheral Module Nodes Table
PNINFO	Ported Number Routing Information Table (MMP only)
PNSCRN	Ported Number Screening Table (MMP only)
PODPATTR	Public Office Dialing Plan Attributes Table
POECNM	Path of Entry Characteristic Name Table
POECSCRN	Path of Entry Characteristic Screening Table
PORTNUMS	Portable Numbers Table
POSITION	Position Table
POSNAME	List of Position Names Table
PRECONF	Preset Conference Table
PREFHUNT	Preferential Hunt List Member Table
PREPLANS	Network Management Preplan Table
PRIPROF	Primary Rate Interface Profile Table
PRTN2CCD	Pretranslator to CC Translator Name Table
PRTTONET	Partition Number to NETINFO Mapping Table

Table 3-1 (Sheet 65 of 87)

Short name	Title
PS	Program Store Assignment Table
PSCNUM	Private Speed Call Number Table
PSNAILUP	P-Side Nail-Up Table
PSTNTRK	Public Switched Telephone Network Trunk Table
PTIDTAB	Port Identifier Table
PTP	TOPS Point-to-Point Rating Table
PVCINFO	Permanent Virtual Circuit Information Table
PVCTYPE	Permanent Virtual Circuit Type Table
PVDNAGEN	Private Virtual Data Network Agent Table
PVDNCHAN	Private Virtual Data Network Channel Table
PVDNCUST	Private Virtual Data Network Customer Table
PVDNCUST.AGENTS	Private Virtual Data Network Customer Agents Subtable
PVDNCUST.CONNECT	Private Virtual Data Network Customer Connect Subtable
PXCODE	Prefix Code Table
PXHEAD	Prefix Code Head Table
PXLAMAP	ISDN Pretranslation Map Table
PXRTE	Prefix Code Route Table
QAPLNDEF	Queue Management System Application Definition Table
QCLASS	ITOPS Automatic Call Distribution Call Classes Table
QDEF	ITOPS Automatic Call Distribution Call Queues Table
QMSCQDEF	Queue Management System Call Queue Definition Table
QSMIS	QMS MIS Link Definition Table
QMSTOPS	Queue Management System TOPS Initial Call Type Assignment Table
QPROFILE	ITOPS Automatic Call Distribution Operator Call Handling Table
QPROP	ITOPS Automatic Call Distribution Call Properties Table

Table 3-1 (Sheet 66 of 87)

Short name	Title
QT0-QT5D	OOO Day Queue Length Threshold Table
QT0-QT5H	ITOPS Queue Length Threshold High Traffic Table
QT0-QT5L	ITOPS Queue Length Threshold Low Traffic Table
QT0-QT5N	OOO Night Queue Length Threshold Table
QTHRESH	ITOPS Queue Threshold Limits Table
QTTIDXD	OOO Day Queue Length Threshold Table Index Table
QTTIDXH	ITOPS Queue Length Threshold High Traffic Table Index Table
QTTIDXL	ITOPS Queue Length Threshold Low Traffic Table Index Table
QTTIDXN	OOO Night Queue Length Threshold Table Index Table
R2BILSRV	R2 Billing Service Table
R2CLGSRV	ITOPS Mapping R2 Trunk Signal to Table ITOPSERV Index Table
R2PROT	R2 Protocol Description Table
RADR	Receiver Attachment Delay Recorder Table
RAINV	Resource Aggregate Inventory Table
RALNK	Resource Aggregate Link Table
RAO	TOPS Domestic RAO Codes Table
RAOCHECK	TOPS RAO Check Table
RASLAPPL	Robust Application Session Layer Application Table
RATEAREA	Rate Area Table
RATEMOD	TOPS Rate Break Map Table
RBKMAP	TOPS Rate Break Map Inactive Table
RBKMAPI	TOPS Rate Break Set Table
RBKSET	TOPS Rate Break Set Inactive Table
RBKSETI	Remote Cluster Controller Inventory Table
RCCINV	Remote Cluster Controller P-Side Link Inventory Table
RCCPSINV	Remote Call Forwarding Calling Line Identification Table

Table 3-1 (Sheet 67 of 87)

Short name	Title
RCFCLI	Remote Call Forwarding Calling Line Identification Table
RCNAME	ISDN Routing Characteristic Name Table
RCSINV	Remote Concentrator Subscriber Inventory Table
RCTALM	Remote Concentrator Terminal Alarm Table
RCTINV	Remote Concentrator Terminal Inventory Table
RCUALRMS	Remote Carrier Urban Alarms Table
RCUINV	Remote Carrier Urban Inventory Table
RDTINV	Remote Digital Terminal Inventory Table
RDTLT	Remote Digital Terminal Line Termination Table
REASONS	Business Set Reason Display Table
RECEIVER	Receiver Table
REGNUM	TOPS Region Name Table
REMNACD	Remote Network Automatic Call Distribution Table
REMOTLAC	Remote Location Area Code Table
REPLCODE	Replace Code Table
REPLDATA	Replace Dialed Digits Database Table
REPLNAME	Replace Name Table
REROUTE	Network Management Reroute Control Table
REROUTE.NWMRROUT	Network Management Reroute Subtable
RESFEAT	Residential Line Feature Table
RESGROUP	Resource Group Table
RESINV	Resource Inventory Table
RESMEM	Resource Member Table
RESNAME	Reseller Name Table (MMP only)
RESOFC	Residential Line CLASS Office Data Table
RESTAMA	TOPS Restricted Automatic Message Accounting Table

Table 3-1 (Sheet 68 of 87)

Short name	Title
RESTBIL	TOPS Restricted Billing Table
REXINTEN	Routine Exercise Intensity Table
REXSCHED	Routine Exercise Schedule Table
RLOGCLAS	Remote Log Class Table
RGSIGSYS	Register Signaling System Table
RGSIGSYS(FDCPSPS)	FDCPSPS (Type FDCPSPS) Subtable
RGSIGSYS(MF3)	Three-phase Frequency Pulse Signaling (Type MF3) Subtable
RGSIGSYS(MFCR2)	MF Compelled R2 Signaling (Type MFCR2) Subtable
RGSIGSYS(NTRS03)	MF Pulse Packet Type 2 Signaling (Type NTRS03) Subtable
RGSIGSYS(NTRS04)	R1 Modified Signalling (Type NTRS04) Subtable
RGSIGSYS(NTRS05)	E and M Signaling (Type NTRS05) Subtable
RGSIGSYS(NTRS10)	MF Pulsed Signaling (Type NTRS10) Subtable
RGSIGSYS(NTRS11)	MF C R2 Signaling (Type NTRS11) Subtable
RGSIGSYS(NTRS12)	Socotel Compelled Trunk Register Signaling (Type NTRS12) Subtable
RGSIGSYS(NTRS14)	MF Pulse Packet Type 1 Signaling (Type NTRS14) Subtable
RLOGDEV	Remote Log Device Table
RLOGTAB	Remote Log Table
RLSCMAP	Release Call Cause Mapping Table (MMP only)
RMCONFIG	Remote Access Configuration Table
RMMINV	Remote Maintenance Module Table
RNDING	ITOPS Rating Charge Calculator Charge Rounding Table
ROTLCB	Remote Office Test Line Callback Table
ROTLSCSD	Remote Office Test Line Scan And Signal Distributor Table
ROUND	TOPS Charge Rounding Table
ROUNDI	TOPS Charge Rounding Inactive Table

Table 3-1 (Sheet 69 of 87)

Short name	Title
ROUTEMAP	Route Map Table
RMPCKT	Remote Maintenance Pack Circuit Table
RPINV	Resource Profile Inventory Table
RPLNK	Resource Profile Link Table
RSDTLNE	Restricted Dial Tone Line Table
RSFOR	ITOPS Rating Rate Step Calculator Foreign Rating Table
RSLOC	ITOPS Rating Rate Step Calculator Local Rating Table
RSM	Remote Service Module Table
RSNAT	ITOPS Rating Rate Step Calculator National Rating Table
RSSERV	TOPS Active Service Rating Table
RSSERVI	TOPS Inactive Service Rating Table
RTECHAR	ISDN Routing Characteristic Table
RTSALGO	Return-to-Service Algorithm Table
RTSNT	Return-to-Service Node Types Table
SAAUTO	Automatic Service Analysis Table
SACB	Subscriber-Activated Call Blocking Table
SACODES	Service Analysis Codes Table
SAIDOFD	Speech Activated Intelligent Dialing Optionality Table
SAQSIZE	Service Assistant/In-Charge Queuing Size Table
SASPEC	Service Analysis Specification Table
SATOVER	Double Satellite Override Table
SAUSERS	Service Analysis Users Table
SCAICOMS	Switch Computer Application Interface Linkset Table
SCAIGRP	Switch Computer Application Interface Group Table
SCAILNKS	Switch Computer Application Interface Link Table
SCAIPROF	Switch Computer Application Interface Profile Table

Table 3-1 (Sheet 70 of 87)

Short name	Title
SCAISRVC	Switch Computer Application Interface Service Profiles Table
SCAISSRV	Switch Computer Application Interface Subservices Table
SCAISVID	Switch Computer Application Interface Service Identification Table
SCALLTAB	Speed Calling Table
SCCPTMR	SCCP Class 2 Timers Table
SCGRP	Scan Group Table
SCHED	TOPS Rate Schedule Table
SCHDEF	ITOPS Rating Rate Step Calculator Schedule Table
SCHDEFI	ITOPS Inactive Rating Rate Step Calculator Schedule Table
SCHEDI	TOPS Rate Schedule Inactive Table
SCHNAME	ITOPS Rating Rate Step Calculator Schedule Table
SCHNUM	TOPS List of Rate Schedule Names Table
SCPCOMP	Service Control Point Component Inventory Table
SCPDB	Service Control Point Service Inventory Database Table
SCPLOCSS	DMS-SCP Local Subsystem Management Table
SCPSERV	Service Control Point Service Parameters Table
SCRNAMES	Screening Class Names Table
SCRNCLAS	List of Screening Class Names Table
SCRNNAME	Screening Name Table
SCUFEAT	Speed Calling User Feature Table
SDGRP	Signal Distributor Group Table
SDMBILL	SuperNode Data Manager Billing Table
SDSCUST	Special Delivery Service Customer Group Information Table
SDSINFO	Special Delivery Service Information Table
SEASMP	SEAS Multiprotocol Controller Table
SEILINKS	Service Evaluation System Table

Table 3-1 (Sheet 71 of 87)

Short name	Title
SERVICE	Automatic Calling Card Service Table
SERVICES	TOPS Services Table
SERVINFO	Intelligent Network Service Information Table (MMP only)
SERVNAME	TOPS Service Rating Name Table
SERVPROF	Service Profile Table
SERVSCRN	TOPS Service Screen Table
SERVZONE	Service Zone Table (MMP only)
SFWALARM	Software Alarm Table
SHADOW	Shadow Sets Table
SIGACT	XPM Incoming Signal to Activity Mapping Table
SILCNWM	Selective Incoming Load Control Table
SITE	Site Table
SITEDIAL	Business Group and Site Identification to Dialing Plan Mapping Table
SITELOC	Business Group and Site Identification to Location Code Access Mapping Table
SLELIST	Screening List Editing List Table
SLLNKDEV	SL-100 Link Device Table
SLM	System Load Module Table
SLNWK	SL-100 Network Control Table
SLQGRP	Single Line Queue Group Table
SLTANIID	Special Line Traffic Automatic Number Identification Table
SNIXAPPL	SuperNode UNIX Application Table
SNIXINFO	SuperNode UNIX Configuration Data Table
SNIXVOLS	SuperNode UNIX Disk Volumes Table
SNPANAME	Serving Numbering Plan Area Name Table
SNVLGRP	Service Node Voice Link Group

Table 3-1 (Sheet 72 of 87)

Short name	Title
SOFTKEY	Softkey Table
SORLIST	Station Origination Restrictions List Table
SPCCON	Semi-Permanent Connections Connection Table
SPCTRKS	Stored Program Control Trunks Table
SPECCONN	P-Side to P-Side Special Connection Table
SPECIAL	Special Table
SPID	Service Provider Identifier Table
SPIDDB	Service Provider Identifier Database Table
SPIDGRP	Service Provider Identifier Group Table
SPINFO	Service Provider Information Table
SPLANILN	Special Automatic Number Identification Line Table
SPLDNID	TOPS Special Directory Number ID Table
SPMROUTE	Service Peripheral Module Routing Table
SPMTKMEM	Service Peripheral Module Trunk Member Table
SRDBXFER	Selective Routing Database File Transfer Scheduler Table
SRVCIND	Service Indicators Table
SRVRS	TOPS Service Rating Table
SSETNAME	ITOPS Rating Rate Step Calculator Schedule Set Table
SSPTKINF	Number Service Code Trunk Groups Table
SSRDEF	Switch Status Report Definition Table
SSRFORM	Switch Status Report Formula Table
STDPRTCT	List of Standard Pretranslation Tables Table
STDPRTCT.AMAPRT	Automatic Message Accounting Pretranslator Subtable
STDPRTCT.STDPRT	Standard Pretranslator Subtable
STDPRTCT.STDPRT(D)	Pretranslator Route Selector D (Selector D) Subtable
STDPRTCT.STDPRT(E911)	Pretranslator Route Selector E911 (Selector E911) Subtable

Table 3-1 (Sheet 73 of 87)

Short name	Title
STDPRTCT.STDPRT(EA)	Pretranslator Route Selector Equal Access (Selector EA) Subtable
STDPRTCT.STDPRT(ET)	Pretranslator Route Selector ET (Selector ET) Subtable
STDPRTCT.STDPRT(F)	Pretranslator Route Selector F (Selector F) Subtable
STDPRTCT.STDPRT(FGB)	Pretranslator Route Selector FGB (Selector FGB) Subtable
STDPRTCT.STDPRT(FGDC L)	Pretranslator Route Selector FGDC L (Selector FGDC L) Subtable
STDPRTCT.STDPRT(ID)	Pretranslator Route Selector ID (Selector ID) Subtable
STDPRTCT.STDPRT(L)	Pretranslator Route Selector L (Selector L) Subtable
STDPRTCT.STDPRT(N)	Pretranslator Route Selector N (Selector N) Subtable
STDPRTCT.STDPRT(NSC)	Pretranslator Route Selector Number Service Code (Selector NSC) Subtable
STDPRTCT.STDPRT(P)	Pretranslator Route Selector P (Selector P) Subtable
STDPRTCT.STDPRT(R)	Pretranslator Route Selector R (Selector R) Subtable
STDPRTCT.STDPRT(S)	Pretranslator Route Selector S (Selector S) Subtable
STDPRTCT.STDPRT(SFMT)	Pretranslator Route Selector SFMT (Selector SFMT) Subtable
STDPRTCT.STDPRT(SSP)	Pretranslator Route Selector Service Switching Point (Selector SSP) Subtable
STDPRTCT.STDPRT(T)	Pretranslator Route Selector T (Selector T) Subtable
STDPRTCT.STDPRT(V)	Pretranslator Route Selector V (Selector V) Subtable
STDPRTCT.STDPRT(Z)	Pretranslator Route Selector Z (Selector Z) Subtable
STIDX	Signaling Terminal Index Table
STINV	Signaling Terminal Inventory Table
STN	Special Tone Table
STPOOLS	Signaling Terminal Pools Table
STREAM	Stream Table
STSTONET	Serving Translation Scheme Table
SUBGRP	Attendant Subgroup Table

Table 3-1 (Sheet 74 of 87)

Short name	Title
SUBPROT	Subtable Protection Table
SUPERTKG	Super Trunk Group Table
SUR	TOPS Surcharge Table
SURI	TOPS Surcharge Inactive Table
SUSHELF	Service Unit Shelf Table
SVCDATA	Switch Packet Configuration Table
SVCRATE	Rate Period Table
SVPRIGRP	Serving PRI Groups Table
SVRCKT	Service Circuit Table
SYLNKINV	Synchronous Link Inventory Table
SYNCLK	Synchronous Clock Table
SYNOGLNK	Synchronous Outgoing Timing Link Table
SYSDATA	System Data Table
TABLES	Tables Table
TABMON	Table Monitoring Table
TAPIDTAB	Physical Tap Identifier Table
TARFDISC	Tariff Discount Table (MMP only)
TARFINDX	Tariff Index Table (MMP only)
TARIFF	TOPS List of Tariff Names Table
TASIB	DLC Unit Scan and SD Card Assignment Table
TAXES	TOPS Taxes Table
TAXESI	TOPS Taxes Inactive Table
TAXFIX	ITOPS Rating Charge Calculator Tax Rates Map Table
TAXMAP	TOPS Schedule Taxes Mapping Table
TAXMAPI	TOPS Schedule Taxes Mapping Inactive Table
TAXMAPS	ITOPS Rating Charge Calculator Schedule Taxes Mapping Table

Table 3-1 (Sheet 75 of 87)

Short name	Title
TAXRATE	ITOPS Rating Charge Calculator Tax Rates Table
TCAPTRID	TCAP Transaction Identifier Table
TCLG7DIG	TOPS Calling Seven Digit Number Table
TCLGVER	TOPS Calling Number Verification Table
TCNDATA	Travel Card Number Data Table
TCNFAST	Travel Card Number FAST Table (MMP only)
TDBCLASS	TOPS Database Class Information Table
TDBDAOPT	TOPS Database Directory Assistance Options Table
TDBNORM	TOPS Database Normalization Data Table
TDBSERV	TOPS Database Services Table
TDCDEF	TOPS Message Switch Data Channel Definition Table
TDCHLDY	Multiunit Message Rate Holiday Table
TDCSCHED	Multiunit Message Rate Day & Time Treatment Table
TEAMACD	TOPS Automatic Call Distribution Table
TERMDEV	Terminal Device Table
TERMRC	TOPS Point-to-Point Rating Terminating Rate Centers Table
TERMRCI	TOPS Point-to-Point Rating Terminating Rate Centers Inactive Table
TERMSCRN	TOPS ACCS Terminating Code Screening Table
TEXTLOG	Logical Display Text Table
TEXTPHRS	Text Phrases Table
TFANINT	Traffic Separation Intersection Table
TFSSCRN	Toll-Free Service Screening Table (MMP only)
TIESCDIG	Trigger Item Escape Digits Table (MMP only)
TIMEODAY	Time Of Day Table
TIMESPEC	Timed Semi-Permanent Connections Table
TIMEZONE	ITOPS Rating Charge Calculator Time Zone Table

Table 3-1 (Sheet 76 of 87)

Short name	Title
TKCVDATA	Mass Trunk Conversion Data Table
TKTONODE	Dynamically Controlled Routing Trunk Groups from Dynamically Controlled Routing Offices Table
TKFXPT	Trunk Frame Access Table
TKMTRNAM	Trunk Meter Names Table
TKSIGSYS	Trunk Signaling System Table
TMINV	Trunk Module Inventory Table
TMSOCDL	TOPS Message Switch Operator Centralization Data Link Group Table
TMSPSDEV	TOPS Message Switch P-Side Device Table
TMSPVC	TOPS Message Switch Permanent Virtual Circuit Table
TMTCNTL	Treatment Control Table
TMTCNTL.TREAT	Treatments Subtable
TMTMAP	Treatment to Cause Map Table
TMZONE	TOPS Time Zone Variation Table
TODCHG	Time of Day Charge Table
TODHEAD	Time of Day Head Table
TOFCNAME	Terminating Office Name Table
TOLLENTC	Entry Code Table
TOLLTRKS	Toll Trunks Table
TONES	Tones Table
TOPAMAOP	TOPS Automatic Message Accounting Options Table
TOPAUDIO	TOPS Audio Table
TOPCACAR	TOPS Competitive Access Carrier Table
TOPCATRK	TOPS Global Competitive Access Trunk Table
TOPEACAR	TOPS Equal Access Carrier Table
TOPEATRK	Equal Access Carrier Information for Trunk Group Type TOPS Table

Table 3-1 (Sheet 77 of 87)

Short name	Title
TOPEATRM	TOPS Equal Access Terminating Screening Table
TOPLNPOP	TOPS Local Number Portability Options Table
TOPS	Digit Translation Routing to TOPS Table
TOPSACTS	TOPS Automatic Coin Toll Service Table
TOPSAMA	TOPS Automatic Message Accounting Table
TOPSBC	TOPS Billing Code Table
TOPSBPC	TOPS Billing Party Category Table
TOPSCOIN	TOPS Coin Table
TOPSDB	TOPS Database Information Table
TOPSDEV	TOPS Device Table
TOPSDISP	Expanded Operator Display Table
TOPSDP	TOPS Dial Plan Table
TOPSENTC	TOPS Entry Code Table
TOPSHDLC	TOPS Data Link Controller Table
TOPSLANG	TOPS Language Table
TOPSOIC	TOPS Office Identification Code Table
TOPSPARM	TOPS Office Parameter Table
TOPSPFX	TOPS Prefix Digits Table
TOPSPOS	TOPS Position Table
TOPSQAGE	TOPS Queue Aging Table
TOPSR2	TOPS with R2 Protocol Table
TOPSSN	TOPS Mapping SNID to Service Number Table
TOPSSNCD	TOPS Mapping SNCD, NPA-Nxx and Locality Index to SNID Table
TOPSTERM	TOPS Keying Sequence Enabling ANI to OOC Table Trunk Options Table
TOPSTOPT	TOPS Trunk Options Table

Table 3-1 (Sheet 78 of 87)

Short name	Title
TOPSTRBL	TOPS Operator Reporting Trouble Disposition Table
TOPSVNIN	TOPS Virtual Node Inventory Table
TOPSZONE	TOPS Zone Table
TOPTDROP	TOPS Call Detail Recording Record Options Table
TPCINV	TOPS Position Controller Inventory Table
TQCAPROF	TOPS Queue Management System Call Queue Profiles Table
TQCARDIG	TOPS QMS Carrier Digits Table
TQCARNAM	TOPS QMS Inter-LATA Carrier Name Table
TQCATDEF	TOPS QMS Call Category Definition Table
TQCATNAM	TOPS QMS Call Category Name Table
TQCLDDIG	TOPS QMS Called Digits Table
TQCLDNAM	TOPS QMS Called Names Table
TQCLSDEF	TOPS QMS Call Class Definition Table
TQCLSNAM	TOPS QMS Call Class Name Table
TQCQINFO	TOPS QMS Call Queue Information Table
TQCQPROF	TOPS QMS Call Queue Profile Table
TQCTPROF	TOPS QMS Call Queue Profile Table
TQDAYDEF	TOPS QMS Day Type Definitions Table
TQDAYNAM	TOPS QMS Day Names Table
TQFMCLAS	TOPS QMS Force Management Class of Service Table
TQFMCLDT	TOPS QMS Force Management Called Number Type Refinement Table
TQFMCT4Q	TOPS QMS Initial Force Management Call Type Value Table
TQFMNAMS	TOPS QMS Force Management Call Type Names Table
TQFMREST	TOPS QMS Force Management Call Type Restricted Billing Table
TQHOLIDAY	TOPS QMS Holiday Table

Table 3-1 (Sheet 79 of 87)

Short name	Title
TQMISOPT	TOPS QMS MIS Office Parameters Table
TQMSFCQA	TOPS QMS Final Call Queue Assignment Table
TQMSOPT	TOPS QMS Parameters Table
TQMSSERV	TOPS QMS Services Names Table
TQOGTKEY	TOPS QMS Operator Key to Call Type for Queuing Table
TQOPROF	TOPS QMS Operator Profile Table
TQORDERA	TOPS QMS Call Type for Queuing Relative Ordering A Table
TQORDERB	TOPS QMS Call Type for Queuing Relative Ordering B Table
TQORGDIG	TOPS QMS Originating Digits Table
TQORGNAM	TOPS QMS Originating Names Table
TQSPIDNM	TOPS Queue Management System Service Provider Identifier Name Table
TQSRNDIG	TOPS QMS Special Location Routing Number Digilator Table
TQSRNNAM	TOPS QMS Special Location Routing Number Name Table
TQSVPROF	TOPS QMS Service Profile Table
TQTIMENM	TOPS QMS Time Names Table
TQWKDAY	TOPS QMS Days of the Week Table
TRAFSAMP	TOPS Traffic Sampling Table
TRBLCODE	IBN Console Trouble Code Table
TRIGDIG	Trigger Digits Table
TRIGESC	Trigger Escape Codes Table
TRIGGRP	Trigger Group Table
TRIGINFO	Trigger Information Table
TRIGITM	Trigger Item Identifier Table
TRKAIN	Trunk Group AIN Trigger Table
TRKAREA	International TOPS Trunk Group Area Code Prefix Table

Table 3-1 (Sheet 80 of 87)

Short name	Title
TRKCGPN	Trunk Calling Party Number Table
TRKDCTS	Trunk Destination Code Traffic Summary Table
TRKGRP	Trunk Group Table
TRKGRP(A5)	OG/2W from Local to N E AMR5 Trunk Group (Type A5) Subtable
TRKGRP(AI)	Automatic Intercept System Trunk Group (Type AI) Subtable
TRKGRP(AN)	Automatic Number Announcement Trunk Group (Type AN) Subtable
TRKGRP(ANI)	Automatic Number Identification Trunk Group (Type ANI) Subtable
TRKGRP(ASP)	Advanced Services Protocol Trunk Group (Type ASP) Subtable
TRKGRP(ATC)	Access Tandem to Carrier Trunk Group (Type ATC) Subtable
TRKGRP(CA)	Come-Again Signaling Trunk Group (Type CA) Subtable
TRKGRP(CELL)	Cellular Trunk Group (Type CELL) Subtable
TRKGRP(CISANI)	Commonwealth of Independent States Automatic Number Identification (Type CISANI) Subtable
TRKGRP(DA)	Directory Assistance Charging Trunk Group (Type DA) Subtable
TRKGRP(DS0)	Trunk Group (Type DS-0) Subtable
TRKGRP(E911)	Enhanced 911 Trunk Group (Type E911) Subtable
TRKGRP(ES)	Outgoing to Emergency Service Bureau Trunk Group (Type ES) Subtable
TRKGRP(GER2W)	Two-way 1TR7 ISUP Trunk Group (Type GER2W) Subtable
TRKGRP(GERIC)	Incoming 1TR7 ISUP Trunk Group (Type GERIC) Subtable
TRKGRP(GEROG)	Outgoing 1TR7 ISUP Trunk Group (Type GEROG) Subtable
TRKGRP(GW)	Gateway Trunk Group (Type GW) Subtable
TRKGRP(IBNT2)	IBN Two-way Trunk Group (Type IBNT2) Subtable
TRKGRP(IBNTI)	IBN Incoming Trunk Group (Type IBNTI) Subtable
TRKGRP(IBNTO)	IBN Outgoing Trunk Group (Type IBNTO) Subtable
TRKGRP(IET)	Inter-Exchange Trunk Group (Type IET) Subtable
TRKGRP(INT101)	Gateway 101 Test Trunk Group (Type INT101) Subtable

Table 3-1 (Sheet 81 of 87)

Short name	Title
TRKGRP(IR)	Outgoing No Outpulsing Trunk Group (Type IR) Subtable
TRKGRP(IS)	Tandem Switching No-Digits Incoming Trunk Group (Type IS) Subtable
TRKGRP(IT)	Intertoll Trunk Group (Type IT) Subtable
TRKGRP(ITL2)	International 102 Test Trunk Group (Type ITL2) Subtable
TRKGRP(ITOPS)	International TOPS Trunk Group (Type ITOPS) Subtable
TRKGRP(LOOPA)	Line Loop Test Unit Trunk Group (Type LOOPA) Subtable
TRKGRP(LP4W)	Four-Wire Digital Loop Test Line Trunk Group (Type LP4W) Subtable
TRKGRP(LPBK)	Loopback Trunk Group (Type LPBK) Subtable
TRKGRP(MAINT)	Maintenance Trunk Group (Type MAINT) Subtable
TRKGRP(MTR)	International Trunk Group (Type MTR) Subtable
TRKGRP(NFA)	Network Facility Access (Type NFA) Trunk Group Subtable
TRKGRP(NU)	Nailed-Up Connection Trunk Group (Type NU) Subtable
TRKGRP(OC)	OG/2W from Local to CAMA Trunk Group (Type OC) Subtable
TRKGRP(OI)	Incoming Operator Trunk Group (Type OI) Subtable
TRKGRP(OP)	OG/2W from Local/Toll to TOPS/TSPS Trunk Group (Type OP) Subtable
TRKGRP(OPR)	International Trunk Group (Type OPR) Subtable
TRKGRP(OS)	Outgoing from Toll Trunk Group (Type OS) Subtable
TRKGRP(P2)	Two-way DID/DOD PBX Trunk Group (Type P2) Subtable
TRKGRP(PRA)	Primary Rate Access Trunk Group (Type PRA) Subtable
TRKGRP(PRIVLN)	Private Line Trunk Group (Type PRIVLN) Subtable
TRKGRP(PX)	2W DID/DOD PBX Digital Trunk Group (Type PX) Subtable
TRKGRP(RC)	Recording Completing Trunk Group (Type RC) Subtable
TRKGRP(RONI)	TOPS Remote ONI Trunk Group (Type RONI) Subtable
TRKGRP(ROTL)	Remote Office Test Line Trunk Group (Type ROTL) Subtable
TRKGRP(SC)	2W/IC CAMA/North AMR5 Trunk Group (Type SC) Subtable

Table 3-1 (Sheet 82 of 87)

Short name	Title
TRKGRP(SOCKT)	Transmission Terminating Trunk Group (Type SOCKT) Subtable
TRKGRP(SPC)	Semi-Permanent Connections Trunk Group (Type SPC) Subtable
TRKGRP(T101)	101 Test Line Trunk Group (Type T101) Subtable
TRKGRP(T105)	105 Test Line Trunk Group (Type T105) Subtable
TRKGRP(T2)	Two-way End Office Trunk Group (Type T2) Subtable
TRKGRP(TD)	Incoming and Outgoing Test Desk Trunk Group (Type TD) Subtable
TRKGRP(TDDO)	Tandem Two-Stage Direct Dial Overseas Trunk Group (Type TDDO) Subtable
TRKGRP(TI)	Incoming End Office Trunk Group (Type TI) Subtable
TRKGRP(TL)	CCIS Transmission Link Trunk Group (Type TL) Subtable
TRKGRP(TO)	Outgoing End Office Trunk Group (Type TO) Subtable
TRKGRP(TOPS)	TOPS Trunk Group (Type TOPS) Subtable
TRKGRP(TOPSARU)	TOPS Audio Response Unit Trunk Group (Type TOPSARU) Subtable
TRKGRP(TOPSVL)	TOPS Voice Link Trunk Group (Type TOPSVL) Subtable
TRKGRP(TPS101)	International 101 Test Line Trunk Group (Type TPS101) Subtable
TRKGRP(TTL2)	Terminating 102 Test Line Trunk Group (Type TTL2) Subtable
TRKGRP(UT)	Utility Telemetry Trunk Group (Type UT) Subtable
TRKGRP(VR)	Operator Verification Trunk Group (Type VR) Subtable
TRKGRP(X75)	X75 Trunk Group (Type X75) Subtable
TRKGRP(ZI)	0+ and 0- Tandem to TSPS or TOPS Trunk Group (Type ZI) Subtable
TRKLATA	Trunk Local Access and Transport Area Table
TRKMEM	Trunk Member Table
TRKMTCE	Trunk Maintenance Table
TRKNAME	Trunk Group ADNUM to CLLI Mapping Table
TRKOPTS	Trunk Options Table
TRKRCSEL	Trunk Routing Characteristics Selector Table

Table 3-1 (Sheet 83 of 87)

Short name	Title
TRKSGRP	Trunk Subgroup Table
TRKSGRP(C7UP)	Common Channel Signaling User Part Trunk Subgroup (Type C7UP) Subtable
TRKSGRP(CCITT6)	CCITT No.6 Signaling Trunk Subgroup (Type CCITT6) Subtable
TRKSGRP(DPNSS)	Digital Private Network Signaling No.1 Trunk Subgroup (Type DPNSS) Subtable
TRKSGRP(DS0TL)	DS-0 Transmission Link Signaling Trunk Subgroup (Type DS0TL)
TRKSGRP(FST)	FST Trunk Subgroups (Type FST) Subtable
TRKSGRP(G1TR7)	German Incoming, Outgoing and Two-way Trunk Subgroups (Type G1TR7) Subtable
TRKSGRP(ISDN)	Integrated Services Digital Network Trunk Subgroups (Type ISDN) Subtable
TRKSGRP(JSTD)	Japan Standard Signaling Trunk Subgroups (Type JSTD) Subtable
TRKSGRP(N5)	N5 Trunk Subgroups (Type N5) Subtable
TRKSGRP(R1/R1N5)	R1/R1N5 Trunk Subgroups (Type R1/R1N5) Subtable
TRKSGRP(R2)	R2 Trunk Subgroups (Type R2) Subtable
TRKSGRP(SIGSYS)	SIGSYS Trunk Subgroups (Type SIGSYS) Subtable
TRKSGRP(STD)	STD Trunk Subgroups (Type STD) Subtable
TRKSGRP(STDTL/CCIS6)	Common Channel Interface Signaling No.6 Trunk Subgroups (STDTL/CCIS6) Subtable
TRKSGRP(TUP)	Telephone User Part Trunk Subgroups (Type TUP) Subtable
TRKSGRP(X25)	X.25 Trunk Subgroups (Type X.25) Subtable
TRKSGRP(X75)	X.75 Trunk Subgroups (Type X.75) Subtable
TRTMTACT	Treatment to Activity Mapping Table
TRTMTMFC	Extended Treatment to MFC Activity Translation Table
TSTAB	Table Data Synchronizer Table
TSTCCT	Test Circuit Table
TSTCCTIX	Test Circuit Index Table

Table 3-1 (Sheet 84 of 87)

Short name	Title
TSTEQUIP	Test Equipment Table
TSTLCONT	Test Line Control Table
TSTLCONT.TLNOS	Test Line Number Subtable
TSTXCON	Test Cross Connections Table
TTANTTPG	Test Access Network Trunk Test Position Group Table
TTL4	Terminating Test Line #4 Table
TVDSTRKS	TVDS Trunks Table
UCDGRP	Uniform Call Distribution Group Table
USERINF	User Information Table
UVMRTE	Universal Voice Messaging Route Information Table
UVMSCR	Universal Voice Messaging Screening Table
V5PROV	Version 5.2 Provisioning Table
V5RING	V5 Ring Table (MMP only)
V5SIG	V5 Signaling Attributes Table (MMP only)
VANDH	Vertical and Horizontal Co-ordinates Table
VARACCT	Variable Account Codes Table
VCHIDTAB	Virtual Channel Identifier Table
VERSIONS	Versions Table
VFGDATA	Virtual Facility Group Data Table
VFGENG	Virtual Facility Group Engineering Table
VH	TOPS Vertical & Horizontal Coordinates Table
VIPCODES	VIP Local Exchange Codes Listing Table
VIPDNS	LEC VIP Subscriber Directory Number Listing Table
VIRTGRPS	Virtual Facility Group Table
VLMEM	TOPS Voice Link Member Table
VMXTAB	Voice Message Exchange Table

Table 3-1 (Sheet 85 of 87)

Short name	Title
VPNMAP	Virtual Private Network Translating Index Mapping Table
VPNXLA	Virtual Private Network IBN and Universal Translation Table
VSPROMPTS	Voice Prompts Table
VPSRVDEF	Default Voice Processing Unit Service Configuration Table
VPUSEV	Voice Processing Unit Service Information Table
VRINV	Version Registry Inventory Table
VROPT	Voice Response Option Table
VSNALARM	Voice Service Node Alarms Table
VSNEXTID	Voice Service Node External Identifier Table
VSNMEMBR	Voice Service Node Table
VSNOPT	Voice Service Node Options Table
VSNPAMAP	Virtual Serving Numbering Plan Area Map Table (MMP only)
WATSAUTH	Meridian Digital Centrex Enhanced WATS Authorization Table
WATSBAND	WATS Band Table
WCKCODES	Wild Card Key Table
WCKCODES(ACC)	Account Code Entry (Feature ACC) Subtable
WCKCODES(ACEES)	Attendant Console End-to-End Signaling (Feature ACEES) Subtable
WCKCODES(AUTH)	Authorization Code (Feature AUTH) Subtable
WCKCODES(AUTHVAL)	Authorization Code Validation (Feature AUTHVAL) Subtable
WCKCODES(BUZZ)	Flexible Console Alerting (Feature BUZZ) Subtable
WCKCODES(BVL)	Busy Verification Line (Feature BVL) Subtable
WCKCODES(BVT)	Busy Verification Trunk (Feature BVT) Subtable
WCKCODES(CFS)	Call Forward Station (Feature CFS) Subtable
WCKCODES(DQC)	Display Queued Calls (Feature DQC) Subtable
WCKCODES(GTAC)	Group Trunk Access Control (Feature GTAC) Subtable
WCKCODES(GTGB)	Group Trunk Group Busy (Feature GTGB) Subtable

Table 3-1 (Sheet 86 of 87)

Short name	Title
WCKCODES(GVAC)	Global Virtual Access Control (Feature GVAC) Subtable
WCKCODES(GVGB)	Global Virtual Group Busy (Feature GVGB) Subtable
WCKCODES(LANG)	Flexible Display Language (Feature LANG) Subtable
WCKCODES(MSGIND)	Message Index (Feature MSGIND) Subtable
WCKCODES(NSPRG)	Night Service Programming (Feature NSPRG) Subtable
WCKCODES(PARK)	Parking of Calls by the Attendant (Feature PARK) Subtable
WCKCODES(PVNRMAC)	PVN Remote Access Call Attendant Assistance (Feature PVNRMAC) Subtable
WCKCODES(PVNSRCDN)	PVN Calling Number Attendant Assistance (Feature PVNSRCDN) Subtable
WCKCODES(QTIME)	Attendant Query Time and Date (Feature QTIME) Subtable
WCKCODES(SC10, SC30, SC50 or SC70)	Speed Calling List (Feature SC10, SC30, SC50 or SC70) Subtable
WCKCODES(SERIAL)	Serial Calling (Feature SERIAL) Subtable
WCKCODES(TRBL)	Trouble Code (Feature TRBL) Subtable
WCKCODES(UNPK)	Unparking of Calls by the Attendant (Feature UNPK) Subtable
WCKCODES(WC)	Conference Call (Feature WC) Subtable
WRDNCODE	Write Directory Number Code Table
WSALEOPT	Wholesaling Option Table
X75INFO	X.75 Protocol Information Table
XANNINFO	External Announcement Information Table
XESAINV	Emergency Stand-Alone Inventory Table
XFERADDR	Data Transferal Table
XFERSSYS	Transfer Subsystem Table
XFROPSEL	Transfer Operator Selection Table (Obsolete from TOPS 12)
XLACIC	Translations Carrier Identification Code Table
XLAEAREG	Translations Equal Access Region Table

Table 3-1 (Sheet 87 of 87)

Short name	Title
XLAGRP	Translations Group Table
XLAMAP	ISDN Translation Map Table
XLANAME	List of Translator Names Table
XLAODIGS	Translation Originator Digits Table
XLAPLAN	Translation Plan Table
XLASPID	Translations Service Provider Identifier Table
XPMIPGWY	Extended Peripheral Module Internet Protocol Gateway
XPMIPMAP	Extended Peripheral Module Internet Protocol Map
XPMLFP	XPM Loadfile Patching Table
XSGDEF	X.25/X.75 Services Group Definition Table
ZENITH	TOPS Zenith Number Table
ZONEFOR	Zone Foreign Table
ZONENAT	Zone National Table
ZONEORDR	Zone Order Table

4 NORESTARTSWACT utility

Description

The no-restart-switch-of-activity (NORESTARTSWACT) utility enables you to activate changes to the values of certain office parameters or to data in certain tables. The total system outage during a NORESTARTSWACT is less than 30 s.

The NORESTARTSWACT utility is available only in offices with BCS36 or higher software. It is not available for NT40 offices.

While using this utility, if an error occurs that cannot be corrected by local maintenance personnel, contact the next level of support.

For information about the utility, refer to the *NORESTARTSWACT User Guide*, 297-1001-546.

5 Common entry field LEN

LEN Field Descriptions

Field LEN contains subfields that the line equipment number (LEN) includes. Field LEN is common to many different tables. This field defines the physical location of the equipment that connects to a specified telephone line.

The subfields that field LEN includes are standard for all tables that use this field. The ISDN-specific tables include one additional subfield. The additional subfield is LTID. The LTID defines the location of line equipment for ISDN lines. The tables that use subfield LTID appear in the following table.

Table 5-1 ISDN-specific tables

Table name (short)	Table name (long)
CODECALL	Code Calling Table
FTRGMEMMS	Feature Group Member Table
IBNSC	IBN Speed Calling Table
KSETLINE	Business Set and Data Unit Line Assignment Table
KSETFEAT	Business Set and Data Unit Feature Table
KSETINV	Business Set and Data Unit Inventory Table
MDNMEM	Multiple Appearance Directory Number Member Table
OFRT	Office Route Table
RESFEAT	Residential Line Feature Table
SCUFEAT	Speed Calling User Feature Table
SLELIST	Screening List Editing List Table
<p>Note: The ISDN-specified tables can allow the entry of ISDN and non-ISDN lines. For non-ISDN lines, enter the standard LEN field (SITE, FRAME, ...). For ISDN lines, enter field LTID.</p>	

5-2 Common entry field LEN

Table 5-2 Field descriptions for field LEN (Sheet 1 of 4)

Field	Subfield	Entry	Explanation and action
LEN		see subfields	<p><i>Line equipment number</i></p> <p>For non-ISDN-specified tables, this field contains subfields SITE, FRAME, UNIT, DRAWER or LSG, SHELF, SLOT, and CIRCUIT.</p> <p>For ISDN-specified tables, this field contains LTID for ISDN line datafill. This field contains SITE, FRAME, UNIT, DRAWER or LSG, SHELF, SLOT, and CIRCUIT for non-ISDN line datafill.</p> <p>See the first table in this document for a list of ISDN-specific tables.</p>
	SITE	alphanumeric (1 to 4 characters) or blank	<p><i>Site</i></p> <p>Office parameter USINGSITE is in table OFCOPT. Office parameter UNIQUE_BY_SITE_NUMBERING is in table OFCENG. The value of these office parameter can be Y (yes). The line can be remote from the host. If these conditions occur, enter the site name assigned to the remote location. If the line is at the host, leave the subfield blank. The system enters SITE by default with HOST.</p>

Table 5-2 Field descriptions for field LEN (Sheet 2 of 4)

Field	Subfield	Entry	Explanation and action
	SITE (continued)	alphanumeric (1 to 4 characters) or blank	<p>Office parameter USINGSITE in table OFCOPT can be equal to Y. The value of office parameter UNIQUE_BY_SITE_NUMBERING in table OFCENG can be N (no). If these conditions occur, the entry in subfield SITE is optional. Numbering differs by the office.</p> <p>If a value is:</p> <ul style="list-style-type: none"> entered, the system checks the value for a match in one of the tables with the assigned lines. not entered, the system does not enter data value by default. The system does not check against one of the tables with assigned lines. <p>The first character of all entries for this subfield must be alphabetic.</p> <p>If the value of office parameter USINGSITE in table OFCOPT is N, leave this subfield blank.</p>

5-4 Common entry field LEN

Table 5-2 Field descriptions for field LEN (Sheet 3 of 4)

Field	Subfield	Entry	Explanation and action
	FRAME	numeric (0 to 511)	<p><i>Line module frame number</i></p> <p>Enter the number of the frame with the assigned line card. For digital line modules (DLM), the frame number refers to the logical frame number of the DLM. The frame number does not refer to the frame. Each frame has two logical frames.</p> <p>The frame can contain the following types of peripheral modules (PM):</p> <ul style="list-style-type: none">• ALCM (Austrian line concentrating module)• DLM (digital line module)• ELCM (enhanced line concentrating module)• IPE (intelligent peripheral equipment)• LCMI (ISDN line concentrating module)• LCME (enhanced ISDN line concentrating module)• LDT (line appearance/digital trunk)• LCM (line concentrating module)• LM (line module)• LRU (line resource unit)• RCU (remote carrier urban)

Table 5-2 Field descriptions for field LEN (Sheet 4 of 4)

Field	Subfield	Entry	Explanation and action
	FRAME (continued)		<p>The frame can contain the following types of peripheral modules (PM):</p> <ul style="list-style-type: none"> • RCS (remote concentrator SLC-96) • RCT (remote concentrator terminal) • RDT (remote digital terminal (refer to note below)) • SRU (small remote unit) • SVR (server service) <p>Enter the additional LEN subfields that associate with the PM used for the specified line. The different PM types appear in alphabetical order on the pages that follow. The PM types appear with the entry requirements that correspond.</p> <p><i>Note:</i> This subfield supports five types of RDT modules:</p> <ul style="list-style-type: none"> • RCU (remote carrier urban) • RFT (remote fiber terminal) • GENCS (generic common signaling channel) • GENTMC (generic time-slot management channel) • ICB (integrated channel bank)

ALCM

If the line is on a PM of type ALCM, enter data in subfields UNIT, LSG, and CIRCUIT. These subfields appear in the following table.

Table 5-3 Field descriptions for conditional datafill (Sheet 1 of 2)

Field	Subfield	Entry	Explanation and action
	UNIT	numeric (0 or 1)	<p><i>Line module unit number</i></p> <p>Enter the unit number of the ALCM with the assigned line card.</p>

Table 5-3 Field descriptions for conditional datafill (Sheet 2 of 2)

Field	Subfield	Entry	Explanation and action
	LSG	numeric (0 to 19)	<i>Line subgroup</i> Enter the number of the line subgroup with the assigned line card.
	CIRCUIT	numeric (0 to 31)	<i>Line card circuit number</i> Enter the circuit number of the line subgroup with the assigned line card.

DLM

If the line is on a PM of type DLM, enter data in subfields SHELF, LSG, and CIRCUIT. These subfields appear in the following table.

Table 5-4 Field descriptions for conditional datafill

Field	Subfield	Entry	Explanation and action
	SHELF	numeric (0 or1)	<i>Shelf</i> Enter the number of the shelf with the assigned line card.
	LSG	numeric (0 to 9)	<i>Line subgroup</i> Enter the line subgroup number of the DLM with the assigned line card.
	CIRCUIT	numeric (0 to 31)	<i>Line card circuit number</i> Enter the circuit number in the line subgroup with the assigned line card.

ELCM

If the line is on a PM of type ELCM, enter data in subfields UNIT, LSG, and CIRCUIT. These subfields appear in the following table.

Table 5-5 Field descriptions for conditional datafill

Field	Subfield	Entry	Explanation and action
	UNIT	numeric (0 or 1)	<i>Line module unit number</i> Enter the unit number of the ELCM with the assigned line card. The lower ELCM on the frame is unit 0 and the upper ELCM is unit 1.
	LSG	numeric (0 to 7, 10 to 17)	<i>Line subgroup</i> Enter the line subgroup number of the ELCM with the assigned line card.
	CIRCUIT	numeric (0 to 31)	<i>Line card circuit number</i> Enter the circuit number in the line subgroup with the assigned line card.

IPE

If the line is on a PM of type IPE, enter data in subfields SHELF, LSG, and CIRCUIT. These subfields appear in the following table.

Table 5-6 Field descriptions for conditional datafill

Field	Subfield	Entry	Explanation and action
	SHELF	numeric (0 to 3)	<i>Shelf</i> Enter the number of the shelf with the assigned line card.
	LSG	numeric (0 to 15)	<i>Line subgroup</i> Enter the line subgroup number of the IPE with the assigned line card.
	CIRCUIT	numeric (0 to 31)	<i>Line card circuit number</i> Enter the circuit number in the line subgroup with the assigned line card.

LCM

If the line is on a PM of type LCM, enter data in subfields UNIT, LSG, and CIRCUIT. These subfields appear in the following table.

Table 5-7 Field descriptions for conditional datafill

Field	Subfield	Entry	Explanation and action
	UNIT	numeric (0 or 1)	<i>Line module unit number</i> Enter the unit number of the LCM with the assigned line card. The lower LCM on the frame is unit 0 and the upper LCM is unit 1.
	LSG	numeric (0 to 19)	<i>Line subgroup</i> Enter the line subgroup number of the LCM with the assigned line card.
	CIRCUIT	numeric (0 to 31)	<i>Line card circuit number</i> Enter the circuit number in the line drawer or line subgroup with the assigned line card.

LCME

If the line is on a PM of type LCME, enter data in subfields UNIT, LSG, and CIRCUIT. These subfields appear in the following table.

Table 5-8 Field descriptions for conditional datafill

Field	Subfield	Entry	Explanation and action
	UNIT	numeric (0 or 1)	<i>Line module unit number</i> Enter the unit number of the LCME with the assigned line card.
	LSG	numeric (0 to 15)	<i>Line subgroup</i> Enter the line subgroup number of the LCME with the assigned line card.
	CIRCUIT	numeric (0 to 31)	<i>Line card circuit number</i> Enter the circuit number in the line subgroup with the assigned line card.

LCMI

If the line is on a PM of type LCMI, enter data in subfields UNIT, LSG, and CIRCUIT. These subfields appear in the following table.

Table 5-9 Field descriptions for conditional datafill

Field	Subfield	Entry	Explanation and action
	UNIT	numeric (0 or 1)	<i>Line module unit number</i> Enter the unit number of the LCMI with the assigned line card.
	LSG	numeric (0 to 23)	<i>Line subgroup</i> Enter the line subgroup number of the LCMI with the assigned line card.
	CIRCUIT	numeric (0 to 15)	<i>Line card circuit number</i> Enter the circuit number in the line subgroup with the assigned line card.

LDT

If the line is on a PM of type LDT, enter data in subfields UNIT, LSG, and CIRCUIT. These subfields appear in the following table.

Table 5-10 Field descriptions for conditional datafill

Field	Subfield	Entry	Explanation and action
	UNIT	numeric (0)	<i>Line module unit number</i> Enter the unit number of the LDT to which the line card is assigned.
	LSG	numeric (0)	<i>Line subgroup</i> Enter the line subgroup number of the LDT to which the line card is assigned.
	CIRCUIT	numeric (0 to 23)	<i>Line card circuit number</i> Enter the circuit number in the line subgroup to which the line card is assigned.

LM

If the line is on a PM of type LM, enter data in subfields UNIT, DRAWER, and CIRCUIT. These subfields appear in the following table.

Table 5-11 Field descriptions for conditional datafill

Field	Subfield	Entry	Explanation and action
	UNIT	numeric (0 or 1)	<i>Line module unit number</i> Enter the bay position of the LM with the assigned line card.
	DRAWER	numeric (0 to 19)	<i>Line drawer</i> Enter the line drawer number of the LM unit with the assigned line card.
	CIRCUIT	numeric (0 to 31)	<i>Line card circuit number</i> Enter the circuit number in the line drawer or line subgroup with the assigned line card.

LRU

If the line is on a PM of type LRU, enter data in subfields UNIT, LSG, and CIRCUIT. These subfields appear in the following table.

Table 5-12 Field descriptions for conditional datafill

Field	Subfield	Entry	Explanation and action
	UNIT	numeric (0 to 9)	<i>Line module unit number</i> Enter the unit number of the LRU with the assigned line card.
	LSG	numeric (0 or 1)	<i>Line subgroup</i> Enter the line subgroup number of the LRU with the assigned line card.
	CIRCUIT	numeric (0 to 29)	<i>Line card circuit number</i> Enter the circuit number in the line subgroup with the assigned line card.

RCS

If the line is on a PM of type RCS, enter data in subfields UNIT, LSG, and CIRCUIT. These subfields appear in the following table.

Table 5-13 Field descriptions for conditional datafill

Field	Subfield	Entry	Explanation and action
	UNIT	numeric (0 to 9)	<i>Line module unit number</i> Enter the unit number of the RCS with the assigned line card.
	LSG	numeric (0 to 3)	<i>Line subgroup</i> Enter the line subgroup number of the RCS with the assigned line card.
	CIRCUIT	numeric (0 to 23)	<i>Line card circuit number</i> Enter the circuit number in the line subgroup with the assigned line card.

RCT

If the line is on a PM of type RCT, enter data in subfields UNIT, LSG, and CIRCUIT. These subfields appear in the following table.

Table 5-14 Field descriptions for conditional datafill

Field	Subfield	Entry	Explanation and action
	UNIT	numeric (0 to 9)	<i>Line module unit number</i> Enter the unit number of the RCT with the assigned line card.
	LSG	numeric (0 to 7)	<i>Line subgroup</i> Enter the line subgroup number of the RCT with the assigned line card.
	CIRCUIT	numeric (0 to 31)	<i>Line card circuit number</i> Enter the circuit number in the line subgroup with the assigned line card.

RCU

If the line is on a PM of type RCU, enter data in subfields UNIT, LSG, and CIRCUIT. These subfields appear in the following table.

Table 5-15 Field descriptions for conditional datafill

Field	Subfield	Entry	Explanation and action
	UNIT	numeric (0 to 9)	<i>Line module unit number</i> Enter the unit number of the RCU with the assigned line card.
	LSG	numeric (0 to 18)	<i>Line subgroup</i> Enter the line subgroup number of the RCU with the assigned line card.
	CIRCUIT	numeric (0 to 31)	<i>Line card circuit number</i> Enter the circuit number in the line subgroup with the assigned line card.

RDT of type RCU

If the line is on a PM that is an RDT of type RCU, enter data in subfields UNIT, LSG, and CIRCUIT. These subfields appear in the following table.

Table 5-16 Field descriptions for conditional datafill

Field	Subfield	Entry	Explanation and action
	UNIT	numeric (0 to 9)	<i>Line module unit number</i> Enter the unit number of the RDT with the assigned line card.
	LSG	numeric (0 to RDTINV defined MAX)	<i>Line subgroup</i> Enter the line subgroup number of the RDT with the assigned line card. Table RDTINV defines the maximum entry value for this field.
	CIRCUIT	numeric (0 to RDTINV defined MAX)	<i>Line card circuit number</i> Enter the circuit number in the line subgroup with the assigned line card. Table RDTINV defines the maximum entry value for this field.

RDT of type RFT

If the line is on a PM that is an RDT of type RFT, enter data in subfields UNIT, SHELF, and SLOT. These subfields appear in the following table.

Table 5-17 Field descriptions for conditional datafill

Field	Subfield	Entry	Explanation and action
	UNIT	numeric (0 to 9)	<i>Line module unit number</i> Enter the unit number of the RDT with the assigned line card.
	SHELF	numeric (1 to RDTINV defined MAX)	<i>Shelf</i> Enter a number between 1 and the maximum number that table RDTINV defines. Enter this number to indicate the shelf with the assigned line card.
	SLOT	numeric (1 to RDTINV defined MAX)	<i>Slot</i> Enter a number between 1 and the maximum number that table RDTINV defines. Enter this number to indicate the slot with the assigned line card.

RDT of type GENCS

If the line is on a PM that is an RDT of type GENCS, enter data in subfields UNIT, SHELF, and SLOT. These subfields appear in the following table.

Table 5-18 Field descriptions for conditional datafill

Field	Subfield	Entry	Explanation and action
	UNIT	numeric (0 to 9)	<i>Line module unit number</i> Enter the unit number of the RDT with the assigned line card.
	SHELF	numeric (1 to RDTINV defined MAX)	<i>Shelf</i> Enter a number between 1 and the maximum number that table RDTINV defines. Enter this number to indicate the shelf with the assigned line card.
	SLOT	numeric (1 to RDTINV defined MAX)	<i>Slot</i> Enter a number between 1 and the maximum number that table RDTINV defines. Enter this number to indicate the slot with the assigned line card.

RDT of type GENTMC

If the line is on a PM that is an RDT of type GENTMC, enter data in subfields UNIT, SHELF, and SLOT. These subfields appear in the following table.

Table 5-19 Field descriptions for conditional datafill

Field	Subfield	Entry	Explanation and action
	UNIT	numeric (0 to 9)	<i>Line module unit number</i> Enter the unit number of the RDT with the assigned line card.
	SHELF	numeric (1 to RDTINV defined MAX)	<i>Shelf</i> Enter a number between 1 and the maximum number that table RDTINV defines. Enter this number to indicate the shelf with the assigned line card.
	SLOT	numeric (1 to RDTINV defined MAX)	<i>Slot</i> Enter a number between 1 and the maximum number that table RDTINV defines. Enter this number to indicate the slot with the assigned line card.

RDT of type ICB

If the line is on a PM that is an RDT of type ICB, enter data in subfields UNIT, RDTLINK, and CHANNEL. These subfields appear in the following table.

Table 5-20 Field descriptions for conditional datafill

Field	Subfield	Entry	Explanation and action
	UNIT	numeric (0 to 9)	<i>Line module unit number</i> Enter the unit number of the RDT with the assigned line card.
	RDTLINK	numeric (1 to RDTINV defined MAX)	<i>Remote digital terminal link</i> Enter the RDTLINK number that matches the DS-1 that serves the line.
	CHANNEL	numeric (1 to 24)	<i>Channel</i> Enter the timeslot to which the line is assigned.

SRU

If the line is on a PM of type SRU, enter data in subfields UNIT, LSG, and CIRCUIT. These subfields appear in the following table.

Table 5-21 Field descriptions for conditional datafill

Field	Subfield	Entry	Explanation and action
	UNIT	numeric (0 or 1)	<i>Line module unit number</i> Enter the unit number of the SRU with the assigned line card.
	LSG	numeric (0 to 7)	<i>Line subgroup</i> Enter the line subgroup number of the SRU with the assigned line card.
	CIRCUIT	numeric (0 to 31)	<i>Line card circuit number</i> Enter the circuit number in the line subgroup with the assigned line card.

SVR

If the line is on a PM of type SVR, enter data in subfields GROUP, LSG, and CIRCUIT. These subfields appear in the following table.

Table 5-22 Field descriptions for conditional datafill

Field	Subfield	Entry	Explanation and action
	GROUP	numeric (0 to 3)	<i>Line module group number</i> Enter the group number of the SVR with the assigned line card.
	LSG	numeric (0 to 19)	<i>Line subgroup</i> Enter the line subgroup number of the SVR with the assigned line card.
	CIRCUIT	numeric (0 to 31)	<i>Line card circuit number</i> Enter the circuit number in the line subgroup with the assigned line card.

ISDN lines

For ISDN lines, enter field LTID. Field LTID appears in the following table. Enter field LTID for ISDN-specific tables. See table Table 5-1, "ISDN-specific tables" on page 5-1 for a list of ISDN-specific tables.

Table 5-23 Field descriptions for field LEN

Field	Subfield	Entry	Explanation and action
LTID		see subfields	<i>Logical terminal identifier</i> This field contains subfields LTGRP and LTNUM.
	LTGRP	alphanumeric (1 to 8 characters)	<i>Logical terminal group</i> Enter the name of a group of logical terminals. You must enter this name in field GROUP of table LTGRP. For ISDN terminals, the name of the group is ISDN.
	LTNUM	numeric (1 to 1022)	<i>Logical terminal number</i> Enter a number to identify the logical terminal in the group.

6 Data schema

How the data schema section is organized

Data schema tables are arranged in alphabetical order by short table name. Each table has a unique name, which is the abbreviation of the long table title. For example, table CLLI is the short table name for the Common Language Location Identifier Table.

Subtables appear after their head table. A subtable is a further refinement of a table and can be identified by a table name, followed by a period (.), followed by another table name. For example, CLLIMITCE.DIAGDATA, where CLLIMITCE is the head table and DIAGDATA is the subtable.

Note: Tables OFCENG, OFCOPT, OFCSTD, and OFCVAR are in the *Office Parameters Reference Manual*.

A list of all data schema tables is contained in the chapter "Master list of data schema tables."

Data schema overview

The purpose of data schema is to assist the operating company in preparing office-dependent data for the relevant DMS switching unit.

The office-dependent data is stored in a series of data store lookup tables that are used in conjunction with software programs and circuits to advance each call through the various stages of call processing.

The data schema portion of the document provides functional descriptions of tables and their fields, including valid entries for each field. It does not provide translation information, call progression sequence, or complete feature implementation datafill.

Data schema is divided into modules, with each module describing one table. As new software features are added, or capabilities are enhanced, existing table documents are revised, or new tables are written.

As of BCS35, data schema documentation contains information formerly contained in the publications shown in the following table.

Table 6-1 BCS35 Consolidated data schema publications

Number	Name
297-2001-451	<i>DMS-100 Meridian Customer Data Schema</i>
297-2101-451	<i>DMS-100 Local Customer Data Schema</i>
297-2201-451	<i>DMS-200 Toll Customer Data Schema</i>

As of BCS36, data schema documentation contains information formerly contained in the publications shown in the following table.

Table 6-2 BCS36 Consolidated data schema publications

Number	Name
297-2001-451	<i>DMS-100 Meridian Digital Centrex (MDC) Customer Data Schema</i>
297-2101-451	<i>DMS-100 Local Customer Data Schema</i>
297-2181-451	<i>DMS-100 International Customer Data Schema</i>
297-2201-451	<i>DMS-200 Toll Customer Data Schema</i>
297-2301-451	<i>DMS-300 Gateway Customer Data Schema</i>

After BCS36, the consolidated data schema documentation (297-1001-451) was cancelled. The information in it was modified to correspond to product computing module loads (PCL) based on specific markets and included as part of the *Translations Guide*. Each PCL has its own *Translations Guide* differentiated by a unique NTP layer number (297-yyyy-350) which contains market-specific translations features and data schema documents. For example the *Translations Guide* for PCL LETB004 is identified by NTP

297-8021-350 and contains U.S. DMS-100/DMS-200 and TOPS combination switch translations features and data schema documents.

Table descriptions

Table descriptions are arranged alphabetically according to short table name.

Data schema tables are described under the following headings:

Table name

This section gives the full table name from which the short table name printed on the page header is derived.

Overview

This optional section gives an overview of the system that the table controls.

Functional description

This section describes how the table is accessed and used by the system, as well as its relation with other tables, feature packages, and features. If appropriate, a description of how to add, delete, or change tuples in the table is included. For some tables, flow charts and block diagrams are used to help illustrate the functional description.

Datafill sequence and implications

This section lists other tables that must be datafilled before or after the table being datafilled, as well as office parameters that interact with the table. If appropriate, any implication involving the datafill sequence is included.

Table size

This section gives the minimum and maximum number of tuples allowed in the table. If appropriate, information on memory allocation is also included. For more complicated tables, a formula for calculating the table size is included.

Field descriptions

Descriptions of the fields in the table are presented in table format. The first column is the short field name as it appears on the MAP terminal. The second column is the short subfield name as it appears on the MAP terminal. The third column gives the range of possible entries in the field. The fourth column gives the expanded field name and a description of the entries, including any default values.

If the short field name is followed by a dash (-) and a BCS number, the field is valid for all software releases up to and including the BCS indicated. If the short field name is followed by a BCS number and a dash (-), the field appeared for the first time in the release indicated and is still applicable. For example,

TABINDX (-BCS35) is valid up to and including BCS35. TABINDX (BCS36-) is valid for BCS36 and up. See the following table.

Table 6-3 Field descriptions

Field	Subfield or refinement	Entry	Explanation and action
TABINDX (-BCS35)		numeric (2 to 4 digits)	<i>Table index</i> Enter the index into the table.
TABINDX (BCS36-)		numeric (2 to 4 digits)	<i>Table index</i> Enter the index into the table.

The use of a dash to indicate software release dates is not supported in the PCL environment.

Terms used in the “Field descriptions” section are explained below.

- *Entry* An entry is an alphanumeric combination of characters for a field, a subfield, a refinement, or a vector. Entries are datafilled by Northern Telecom, by the operating company, or by the DMS system. Entire tables that the operating company can access but cannot change are read-only or NT-only tables. Such tables are rarely documented.
- *Field* A field is one column of a table. Each field has a name that describes the content of the field. For example, a field that contains directory numbers can be named field DN.
- *Key field* A key field is found in each table. Tables can have more than one key field. These fields uniquely identify any tuple in the table. Knowing the key fields of a table is important if using the table editor.
- *Range* The range of a field is the set of all possible data values that can be entered in the field. For example, a field called NUMBER can have a range of 1 to 20. RANGE is also a table editor command that can be entered at the MAP terminal to determine the range of a field, subfield, or refinement. The range is shown between curly brackets, { }. When a description of the range is shown instead of curly brackets, the datafill is a variable that depends on other datafill or is an alphanumeric entry to be chosen by the operating company. In the explanation of a range, the phrase “entries outside of the indicated range are invalid” means that values shown at the MAP terminal that are not described in the NTP are not to be used.
- *Subfield* A subfield is a division of a field. For example, the field named LEN most often consists of subfields SITE, FRAME, UNIT, DRAWER, and CIRCUIT.
- *Refinement* A refinement is a field that further modifies the field preceding it, depending on the datafill in the first field. For example, if the entry in

field OPTION in table SCAILNKS is BOCTIME, refinement TIME must be datafilled. If the entry is SCAIRTE, refinement TABNAME must be datafilled.

- *Table editor* The table editor is the user interface to the data schema database. It allows the user to view tables, add or delete tuples, and change data in tuples.
- *Tuple* A tuple is one row of data in a table. A row can be one field or a combination of fields up to all fields in the table. When adding or changing at least one entry of a tuple using table editor commands at a MAP terminal, confirmation of the new tuple is prompted.
- *Value* A value is synonymous with an entry.
- *Vector* A vector is a field that can contain more than one entry. Each entry is separated by a single space. If less than the maximum number of allowed entries is required, the list is ended with a \$ (dollar sign). For example, field OPTCARD in table LTCINV can contain up to ten optional cards. Each entry is separated by a single space and if less than ten optional cards are required, the list is ended with a \$ (dollar sign).

Datafill example

This section shows an example of a MAP display of the datafilled table, using the following format.

SSNAME	PROTCLID	FKEY
OM	3	F15
AMA	1	F13

Where appropriate, explanations are provided for the specific datafill in the example.

Table history

This section lists the BCS or the PCL in which the table changed, with a short description of the change. After BCS36, a BCS software load is referred to as a product computing module load (PCL) identifier.

When a table becomes obsolete, the PCL or software layer is identified. The table document is removed from the NTP during subsequent releases.

Supplementary information

This section contains information that is pertinent to the data schema table but does not logically belong under previous sections. For example, error messages prior to BCS36, or dump and restore procedures are often found here.

Table descriptions for line equipment number (LEN) fields

Because field LEN is common to more than 60 tables, it is documented in a single section to avoid duplication. Each time field LEN occurs in a table, the field description refers to section "Common entry field LEN" for a complete description of field LEN and associated subfields.

Restructured tables

Occasionally a table undergoes major restructure from one BCS or PCL to another. In this case, the BCS markers described under the section "Field descriptions" above are included following the long table name and the short table name.

For example, in BCS36, table IPNETWORK was restructured to the extent that all field names were changed. The table description for BCS36 and up is included in the table description IPNETWORK (BCS36-) while the table description up to and including BCS35 is included in the table description IPNETWORK (-BCS35).

The old version of the table description precedes the new table description in the data schema section of this document.

Cross-reference tables

The following cross-reference tables are provided in the introductory chapters of the data schema section of this document:

- Table completion responsibility
- Master list of data schema tables

AABSFILT

Table name

Automated Alternate Billing Service Filter Table

Functional description

Table AABSFILT expands feature AJ0914 (Traffic Operator Position System [TOPS] terminating code screening) to include the feature AF1104 (Automated Alternate Billing Service [AABS]) so that calling card placed calls can be screened without operator intervention.

Table AABSFILT contains billed numbers for AABS collect and third-party billed calls. These billed numbers can be used to filter future calls for potential fraud or low quality voice transmission or both.

The table allows screening for numbers up to 18 digits in length. This gives the operating company the flexibility to screen individual calling card numbers (14 digits) for fraud, or in the case of low quality voice transmission, a three-digit numbering plan area (NPA) could be used as a screening number.

For related information, refer to table VSNOPT.

Datafill sequence and implications

There is no requirement to datafill other tables prior to table AABSFILT.

The parameter AABS_FRAUD_FILT in table VSNOPT must be set to Y (yes) to allow for potential fraud screening in table AABSFILT.

Table size

0 to 10 000 tuples

AABSFILT (end)

Datafill

The following table lists the datafill for table AABSFILT.

Field descriptions

Field	Subfield or refinement	Entry	Explanation and action
BILLNUM		numeric (1 to 18 digits)	Billed number. Enter the number that is to be filtered.
SCRNFOR		PFRAUD BADVOICE BOTH, or NONE	Screen number condition. Enter the condition that the number is screened for. Enter PFRAUD to screen for potential fraud. Enter BADVOICE to screen for poor quality voice transmission. Enter BOTH to screen for poor quality voice transmission and potential fraud. Enter NONE to skip screening for a number. The option NONE is used so that the operating company can turn the screening off for a particular number, instead of deleting the tuple from the table.

Datafill example

The following example shows sample datafill for table AABSFILT.

MAP display example for table AABSFILT

BILLNUM	SCRNFOR
212220	PFRAUD
214	BADVOICE
609782	BOTH
2129671111	NONE

AABSOST

Table name

Automated Alternate Billing Service Originating Station Treatment Table

Functional description

Table AABSOST allows the operating company to specify which Traffic Operator Position System (TOPS) trunks are eligible for Automated Alternate Billing Service (AABS). Table AABSOST contains one entry for each incoming or two-way TOPS trunk group in the office. Each tuple in table AABSOST consists of two parts. The first part specifies whether calls from public stations arriving over that trunk group are eligible for AABS handling; the second part specifies whether calls from private stations arriving over that trunk group are eligible for AABS handling. For both public and private stations, the following attributes can be specified:

- No AABS service is provided for calls over that trunk group. In this case, 0+ calls over this trunk group are routed to an operator.
- AABS service is provided for calls over that trunk group, in which case, the originating station treatment (OST) must be specified. The OST choices are tone or tone and announcement.
- AABS service eligibility is determined based on the results of a query to a billing validation authority (BVA). In this case, the operating company needs to identify a default OST in case the query to the BVA fails.

Datafill sequence and implications

The following tables must be datafilled after table AABSOST.

- CLLI
- TRKGRP

There is no requirement to datafill other tables prior to table AABSOST.

Table size

0 to 8191 tuples

The size of table AABSOST is controlled by the entry for table TRKGRP in table DATASIZE.

AABSOST (continued)**Datafill**

The following table lists datafill for table AABSOST.

Field descriptions (Sheet 1 of 3)

Field	Subfield or refinement	Entry	Explanation and action
GRPKEY		see subfields	Group key. This field consists of subfield CLLI.
	CLLI	alphanumeric (1 to 16 characters)	Common language location identifier. Enter the CLLI of the Traffic Operator Position System (TOPS) trunk group. The CLLI name must be previously datafilled in tables CLLI and TRKGRP.
PUBLIC		see subfield	Public station. This field consists of subfield STAT.
	STAT	BVCLOOK, NOSERV, or SERV	<p>This is the first part of the tuple. It specifies whether Automated Alternate Billing Service (AABS) is provided on public telephones (hotel, coin, and restricted).</p> <p>Public station status. This field specifies whether AABS is provided for telephone calls from public stations over that trunk group.</p> <p>Enter BVCLOOK if a database query must be made to determine whether AABS is provided and datafill refinement OST.</p> <p>Enter NOSERV if AABS is not provided. Go to field PRIVATE.</p> <p>Enter SERV if AABS is provided and datafill refinement OST.</p>

AABSOST (continued)**Field descriptions (Sheet 2 of 3)**

Field	Subfield or refinement	Entry	Explanation and action
	OST	NOAABS, TONE, or TONEANN	<p>Originating station treatment. This field specifies the type of OST to apply to the line if AABS is provided.</p> <p>Enter NOABBS if no AABS service is provided to the line.</p> <p>Enter TONE if only a tone is applied to the line.</p> <p>Enter TONEANN if both tone and announcement are applied to the line.</p> <p>If field STAT is set to SERV, refinement OST must be set to TONE or TONEANN.</p>
PRIVATE		see subfield	<p>Private station. This field consists of subfield STAT.</p> <p>This is the second part of the tuple. It specifies whether AABS is provided on private telephones.</p>

AABSOST (end)

Field descriptions (Sheet 3 of 3)

Field	Subfield or refinement	Entry	Explanation and action
OST	STAT	BVCLOCK, NOSERV, or SERV	<p>Private station status. This field specifies whether AABS is provided for telephone calls from private stations over that trunk group.</p> <p>Enter BVCLOCK if a database query must be made to determine whether AABS is provided, and datafill refinement OST.</p> <p>Enter NOSERV if AABS is not provided. No further datafill is required.</p> <p>Enter SERV if AABS is provided, and datafill refinement OST.</p>
		NOAABS, TONE, or TONEANN	<p>Originating station treatment. This field specifies the type of OST to apply to the line if AABS is provided.</p> <p>Enter NOABBS if no AABS service is provided to the line.</p> <p>Enter TONE if only a tone is applied to the line.</p> <p>Enter TONEANN if both tone and announcement are applied to the line.</p> <p>If field STAT is set to SERV, refinement OST must be set to TONE or TONEANN.</p>

Datafill example

The following example shows sample datafill for table AABSOST.

MAP display example for table AABSOST

GRPKEY	PUBLIC	PRIVATE
AABSVL	SERV TONE	SERV TONE

Table history

BCS36

Corrected conditional datafill for refinement OST.

ACBTAB**Table name**

All Circuits Busy Table

Functional description

Table ACBTAB sets the threshold values and hysteresis functions for real-time route status functionality.

Datafill sequence and meaning

You do not need to enter data in other tables before you enter data in table ACBTAB.

Tuples are deleted from table TRKSGRP after deletion of the entry that corresponds in table ACBTAB occurs. The values that use table ACBTAB must be calculated again before tuples are added to table TRKMEM.

Table size

0 to 3072 tuples

Datafill

Datafill for table ACBTAB appears in the following table.

Field descriptions (Sheet 1 of 2)

Field	Subfield or refinement	Entry	Explanation and action
CLLI		alphanumeric (1 to 16 characters)	<i>Common language location identifier.</i> This field contains the common language location identifier.
SCANNUM		numeric (0 to 3271)	<i>Scanning number.</i> Enter a numeric value to identify the trunk group position for the scanning process.
MINACB		numeric (0 to 100)	<i>Minimum all circuits busy.</i> Enter a percentage value to indicate the lower state boundary.
MAJACB		numeric (0 to 100)	<i>Major all circuits busy.</i> Enter a percentage value to indicate the middle state boundary.
CRITACB		numeric (0 to 100)	<i>Critical all circuits busy.</i> Enter a percentage value to indicate the highest state boundary.

ACBTAB (end)

Field descriptions (Sheet 2 of 2)

Field	Subfield or refinement	Entry	Explanation and action
ACBDELTA		numeric (0 to 5)	<i>All circuits busy delta.</i> Enter a number to represent a percentage increase and decrement for each of the percentage values entered in fields MINACB, MAJACB and CRITACB. This percentage increase is for hysteresis purposes and acts as a band around each state boundary. This band must be fully crossed before recognition of a change from one state to another can occur. The band is fully crossed to prevent oscillation between states and reduces the amount of output.
ACBSCANS		numeric (0 to 5)	<i>All circuits busy scans.</i> Enter a number to indicate the number of scans for which a changed state must remain constant. The state must remain constant before the scanning process identifies the state change.

Datafill example

Sample datafill for table ACBTAB appears in the following example.

MAP example for table ACBTAB

CLLI	SCANNUM	MINACB	MAJACB	CRITACB	ACBDELTA	ACBSCANS
OTWAON23CG00	124	40	60	75	5	2

ACCINDEX

Table name

Accounting Route Index Table

Functional description

Table ACCINDEX maps an accounting route index (ARI) to the accounting route number (ARN). The switch uses the map to identify a specified call accounting route. Involvement of a TIE route means call accounting purposes require this mapping. The ARN assigned to a specified call accounting route is for only one switch. The specified ARI is different. Performance of the billing occurs on the ARN.

Datafill sequence and meaning

You do not need to enter data in other tables before you enter data in table ACCINDEX.

Table size

1 to 5001 tuples

Datafill

Datafill for table ACCINDEX appears in the following table.

Field descriptions (Sheet 1 of 2)

Field	Subfield or refinement	Entry	Explanation and action
ACCINDEX		0 to 5000	<i>Accounting route index.</i> This field is the key to the table. Enter an accounting route index.

ACCINDEX (end)**Field descriptions (Sheet 2 of 2)**

Field	Subfield or refinement	Entry	Explanation and action
ARI		0 to 4294967295	<p><i>Accounting route index.</i> This field contains two sections. The first section (bits 0 to 11) contains an engineering route for a specified switch. The second section (bits 12 to 15) contains a value that identifies the switch. This value gives a specified value to the accounting route index (field ARN). This value identifies the ARN between a maximum of 16 different switches.</p> <p>Field ARI is the index for this table. Field ARI is passed in the telephone user part (TUP)(E) or ISDN user part (ISUP)(E) message. This message is received from a TIE route. The field ARN value taken from the TIE route is for accounting purposes.</p>
ARN		0 to 320	<p><i>Accounting route number.</i> Field ARN represents an integer count. Enter 0 (zero) to represent the null condition. Enter a value from 1 to 320 to represent the route of the incoming call.</p>

Datafill example

Sample datafill for table ACCINDEX appears in the following example.

MAP example for table ACCINDEX

ACCINDEX	ARI	ARN
60	429000	0

ACCODE

Table name

Access Code Table

Functional description

The following table lists all of the “CODE” tables. Throughout this document, “xxCODE” represents one of the CODE tables.

Universal translation tables

Table name	Form title
ACCODE	Access Code Table Record
AMCODE	Ambiguous Code Table Record
CTCODE	Country Code Table Record
FACODE	Foreign Area Code Table Record
FTCODE	Utility Code Table Record
NSCCODE	Number Service Code Table Record
OFCCODE	Office Code Table Record
PXCODE	Prefix Code Table Record

Each xxCODE table has a corresponding xxHEAD table and xxRTE table. (There is no table AMRTE.) Each type of table is datafilled identically.

The starting point for translations is the xxCODE table given in the trunk data or table NETATTR, using the translation selector UNIV followed by the appropriate translation system and table name. Before the table name can be datafilled, it must be defined in the xxHEAD table of the appropriate translation system. The path through the translation tables is given exclusively by option XLT. Option XLT is specified in selectors CONT or DMOD in the xxCODE table, and in selectors DFOP or DFLT of the xxHEAD table.

In general, if the same option is found in two different tuples during a pass through translations, the value in the last tuple is used. For example, if field CLASS is set to LCL in table PXCODE, it can be reset to NATL in table FACODE.

For related information, refer to table ACHEAD.

ACCODE (continued)

Datafill sequence and implications

The following tables must be datafilled before table xxCODE:

- TERMINFO
- xxHEAD
- xxCODE
- MDESTIDX (only for the Advice of Charge feature)
- SERVPROF
- BCDEF
- NSCDEFS (if translation selector DBQ is used)
- TRKSGRP (if optional selector CGNDM for translation selector DMOD is used)
- LNETWORK (only for the Advice of Charge feature)
- CDNCHAR
- CLISERV

Only automatic number identification (type ANI) and international metering (type MTR) trunk group originations support the option selector CAMA. All other call types ignore this translation option.

For emergency calls translation, class EMRG must be datafilled. This can be done before or after translation selector CONT with option selector CLASS. This requirement differentiates between normal mobile originated calls and emergency calls set up by a conventional SETUP message.

Optional selector CGNDM can be used with translation selector DMOD if the switch is equipped with module IXLACLI and the default Calling Line Identification (CLI) is datafilled in table TRKSGRP. Different default CLIs can be datafilled on requirements. Optional selector CGNDM must also be datafilled in table ACCODE to activate the feature.

The following office parameters affect table xxCODE:

- ICAMA_REQUESTED in table OFCVAR
- IAA_REQUESTED in table OFCVAR
- IMEI_ACCEPTABLE_FOR_EMRG_CALL in table OFCVAR

For option selector CAMA (used in translation selectors CONT, DNRTE, and RTE), set office parameter ICAMA_REQUESTED in table OFCVAR to Y

ACCODE (continued)

(yes) if international centralized automatic message accounting (ICAMA) detailed call recording is required.

An inter-administration accounting (IAA) record can be generated by selecting office parameter IAA_REQUESTED in table OFCVAR, and selector CAMA.

Office parameter IMEI_ACCEPTABLE_FOR_EMERG_CALL in table OFCVAR provides an option for the network operator to accept emergency call setups from mobile stations that transmit the international mobile equipment identity (IMEI) instead of the international mobile subscriber identity (IMSI) or temporary mobile subscriber identity (TMSI). The default value allows emergency call setups with IMEI as the identifier if, for example, no serial interface module (SIM) is present.

Option NETINFO can only be added to selectors CONT and RTE if the option QFT ON is datafilled in the same tuple for which the NETINFO option is added.

Table size

There is no fixed maximum number of tuples in each table, but the maximum total number of tuples is 32 768. The number of tuples is allocated dynamically. Memory is allocated when field XLANAME is datafilled in the xxHEAD table.

Note 1: The maximum number of tuples may vary due to compression and expansion of tuples.

Note 2: Depending on the range of “from digits” and “to digits” within each tuple, the table can run out of room before the maximum of 32 768 tuples is reached. This is due to the number of digilator blocks used by all the tuples in the table.

Note 3: The DMSMON DBLOCKS tool can be used to monitor the size of this table.

Tuple compression

Starting in release TL006, the CONSUME option is always datafilled. If it is not datafilled by the operating company personnel, the universal translation

ACCODE (continued)

(UXLA) system's write procedure automatically adds the datafill and sets it to the original key length. This action is taken for the following reasons:

- The UXLA system only has access to the key length in the write procedure for table xxCODE. It is done at this time so the key length is available if required during call processing.
- If tuple compression or expansion changes the key length, the consume value cannot be updated to reflect these changes. The result is that translations consume the original key length, not the current key length, during call processing. CONSUME is forced to be datafilled to make the operating company personnel aware of the number of digits that are consumed. Therefore, the default option (DFOP) CONSUME is not used.

When a tuple is initially added to table xxCODE, the key length is stored. If the tuple is then split, the new tuple's length is stored for that tuple. At this point, there are three tuples, two of one length, and a third of a different length. If the tuple that is now out of the first range of digits is changed to the original value, it will not compress because the original length of the three tuples is different. See the following examples. (The consume option is not on for any of the tuples in these examples.) The entry "exp_tuple" represents the XLANAME table entry. Original tuple: add exp_tuple 0181 0181 feat... The tuple is split: rep exp_tuple 01818100181810 dnrte... Resulting tuples:

exp_tuple 0181 0181809 feat... (hidden consume = 4)

exp_tuple 0181810 0181810 dnrte... (hidden consume = 7)

exp_tuple 0181811 0181811 feat... (hidden consume = 4)

If the middle tuple is changed back to the original value the result is as follows: rep exp_tuple 0181810 0181810

Resulting tuples:

exp_tuple 0181 0181809 feat... (hidden consume = 4)

exp_tuple 0181810 0181810 feat... (hidden consume = 7)

exp_tuple 0181811 0181 feat... (hidden consume = 4)

The tuples did not compress because the tuples must be identical in content and key length. To compress the tuple see the following:

Enter:

ACCODE (continued)

rep exp_tuple 0181000 018809 feat...

rep exp_tuple 0181811 0181999 feat...

Resulting tuple:

exp_tuple 0181 0181 feat...

If a tuple is added, for example:

add exp_tuple 0182 0182 feat...

Resulting tuples:

exp_tuple 0181 0181 feat... (hidden consume = 7)

exp_tuple 0182 0182 feat... (hidden consume = 4)

To compress these tuples

Enter:

rep exp_tuple 0182000 0182999 feat...

Resulting tuple:

exp_tuple 0181 0182 feat... (hidden consume = 7)

Datafill

The following table lists datafill for table ACCODE and other xxCODE tables.

Field descriptions (Sheet 1 of 3)

Field	Subfield	Entry	Explanation and action
XLANAME		alphanumeric (1 to 8 characters)	Translation name. Enter the name from the corresponding head table.
FROMD		numeric (1 to 11 digits)	From digit. Enter the digit or digits that represent a single number or the first in a block of consecutive numbers that have the same result given in field XLADATA. See the following notes.

ACCODE (continued)**Field descriptions (Sheet 2 of 3)**

Field	Subfield	Entry	Explanation and action
TOD		numeric (1 to 11 digits)	<p>To digits. If field FROMD represents a single number, enter the number that is equal to the number in field FROMD.</p> <p>If field FROMD represents the first number of a block of consecutive numbers, enter the last number in the block. See notes below.</p> <p>Note 1: Adding or changing a tuple affects all digit combinations between fields FROMD and TOD; however, command DELETE only deletes the tuple at field FROMD.</p> <p>Note 2: Because of the way the FROM and TO digit key is implemented, the operation of table control requires additional explanation. For example, a tuple is datafilled with the value in field TOD greater than the value in field FROMD (field FROMD is set to 3 and field TOD is set to 8). If a user positions on a tuple with fields FROMD and TOD within the datafilled range, the tuple is displayed as if only those digits are datafilled as the key.</p> <p>In this example, the user positions on the tuple with fields FROMD and TOD both equal to 5. The tuple is displayed with both fields equal to 5. The information is being requested for the given key. If the user then displays the previous tuple, fields FROMD and TOD contain the digits originally datafilled before the current FROMD digit. In this example, the FROMD and TOD digits are 3 and 8. If the user now displays the next tuple, the digits following the currently displayed TOD field are displayed, 5 and 8.</p>
XLADATA		see subfield	Universal translations data. This field consists of subfield XLASEL. Subfield XLASEL and its refinements are described following the description of field CONTMARK.
CONTMARK		+ or \$	Continuation mark. Enter + if additional information for this tuple is contained in the next record. Otherwise, enter \$ to indicate the end of the tuple.
	XLASEL	CONT, DBQ, DMOD, DNRTE, FEAT, FEATINFO, HRC, IAC, RTE, or TRMT	<p>Translation selector. Enter one of the following values:</p> <p>Enter CONT and datafill its refinements if further translation is required.</p> <p>Enter DBQ and datafill its refinements to perform a database query.</p>

ACCODE (continued)

Field descriptions (Sheet 3 of 3)

Field	Subfield	Entry	Explanation and action
			<p>Enter DMOD and datafill its refinements if the input digit stream requires modification.</p> <p>Enter DNRTE and datafill its refinements if the input digits are routed—normally to a line.</p> <p>Enter FEAT and datafill its refinements if access to a feature is required.</p> <p>Enter FEATINFO and datafill its refinements to trigger the screening function.</p> <p>Enter HRC and datafill its refinements if the home routing code selector is required for local number portability applications.</p> <p>Enter IAC and datafill its refinements if the insertion of own area code is required when an ambiguous area code is found through translations.</p> <p>Enter RTE and datafill its refinements if the call is routed to a trunk.</p> <p>Enter TRMT and datafill its refinements if a call is routed to treatment.</p>

XLASEL = CONT

If the entry in field XLASEL is CONT, datafill the following refinements.

This selector is used if more translation is required. The next table to use is given by option XLT. Option CON in the xxHEAD table entry for the current XLANAME determines whether the digits that were used to index the current table are to be consumed (that is, ignored by the next table). For example, in a pretranslator, the digits are not usually consumed, but they are consumed when continuing from the office code table (OFCCODE) to table DNINV. The consumed digits are not deleted from the digit register; they are ignored for the moment.

Note: If translation continues and no next translation table is specified (with option XLT), UXLA reenters the same table it is currently in. If option CON is set in the xxHEAD table, a new translation results because different digits are used. If a next translation table is not specified and option NOCON is set, UXLA reenters the same table with the same digits, gets the same result, and continues looping through the table.

ACCODE (continued)

It is possible to datafill the tables so that the same table is explicitly reentered, but it is not recommended because it makes the sequence very difficult to follow and prone to error. (The same table refers to the same table in the same translation system. It is correct to enter a different table in the same translation system if option XLT is used.) If the same table is entered, it is datafilled explicitly.

If selector CONT is used, option XLT must be datafilled in the xxCODE table tuple or in the default options (DFOP) of the corresponding xxHEAD table. If selector CONT is used in the default tuple (DFLT), option XLT must be datafilled. The selector DMOD does not use the default options from the xxHEAD table, so option XLT must also be datafilled in the xxCODE table tuple.

Table AMAXLAID must be datafilled prior to selecting option AMAXLAID.

If options CDNRTE and CPCRTE are both present in one tuple in table xxCODE, call processing accesses routing tables in the following order: table CPCUXLA is accessed first. If no match is found, table CDNUXLA is accessed next.

ACCODE (continued)

If options SETCDN and CDNRTE are both present in one tuple in table xxCODE, call processing accesses table CDNUXLA first, before the SETCDN option sets the called number name (CDNNAME).

ACCODE (continued)

Field descriptions for conditional datafill (Sheet 1 of 16)

Field	Subfield	Entry	Explanation and action
	OPT	see subfield	Options. This field is a vector consisting of up to ten options. Each option consists of subfield OSEL and refinements that depend on the entry in subfield OSEL. For each option, specify the option selector (OSEL), followed by a space, and the refinements, each separated by a space. The entry is concluded by a \$. Datafill continues with field DFOP.

ACCODE (continued)**Field descriptions for conditional datafill (Sheet 2 of 16)**

Field	Subfield	Entry	Explanation and action
	OSEL	ACF, AMAXLAID, CALLCTRL, CALLDUR CAMA, CATRTE, CDN, CDNRTE, CHGIND, CLASS, CLIOVRD, CONSUME, CPCRTE, CPMCALL, DDIDX, DEST, DESTOM, DFT, EXTCIC, IAA, LNET, MM, MZONE, NETINFO, NETSRV, NICRF, NOANSTIM, NTAIO, NTAIT, OSS, PCC, PF, PNRF, PORTED, PRESEL, PRIVL, QFT, SETCDN, TELETAXE, TOC, VPN, or XLT	<p>Option selector. The following options can be selected:</p> <p>Enter ACF, followed by a space, and datafill refinement ACF if the area code fence is defined.</p> <p>Enter AMAXLAID, followed by a space, and datafill refinement XLAID to specify an automatic message accounting (AMA) identity from within table AMAXLAID.</p> <p>Enter CALLCTRL, followed by a space, and datafill refinement CALLCTRL. The entry in refinement CALLCTRL indicates who has control of the call: the calling party, the called party, or both.</p> <p>Enter CALLDUR, followed by a space, and datafill requirement CALL_DURATION_TIMER. The entry in refinement CALL_DURATION_TIMER defines the call time limit for Premium Rate Service calls.</p> <p>Enter CAMA, followed by a space, and datafill refinement CLDFMT. The entry in field CLDFMT indicates whether the international centralized automatic message accounting (ICAMA) record is generated with the originally signaled directory number (DN) or the final public switched telephone network (PSTN) number.</p> <p>Enter CATRTE to allow charge category routing in IBN translations.</p> <p>Enter CDN, followed by a space, and datafill refinement CDN to select the nature of address field. This field is used to identify the called party of the initial address message (IAM). This selector is used for Australian ISDN user part (AISUP) call translations.</p>

ACCODE (continued)**Field descriptions for conditional datafill (Sheet 3 of 16)**

Field	Subfield	Entry	Explanation and action
			<p>Enter CDN RTE to route using the called number name (CDNNAME) from table CDNCHAR. If the CDNNAME is present on the incoming call or is set by the SETCDN option, translation proceeds to table CDNUXLA.</p> <p>Enter CHGIND, followed by a space, and enter refinement CHGIND.</p> <p>Enter CLASS, followed by a space, and datafill refinement CLASS if the class of the dialed digits can be determined.</p> <p>Note: For the Japan market, if both the CLASS and IAA options are in use, IAA must precede CLASS in the datafill order.</p> <p>Enter CLIOVRD, followed by a space, and datafill refinement CLIOVRD to block or allow per-call delivery of a calling line identity (CLI). The entry in refinement CLIOVRD indicates whether the CLI can be blocked per-call, CNB (calling number blocked), or CNA (calling number allowed).</p> <p>Enter CONSUME, followed by a space, and datafill refinement CONDIGS to specify the number of digits that are consumed during translation.</p> <p>Enter CPC RTE to route using the calling party category (CPCNAME) from table CPCCHAR. If the CPCNAME is present on the incoming call, translation proceeds to table CPCUXLA.</p> <p>Enter CPMCALL, followed by a space, and datafill refinement CPMCALL to specify call billing against the called party instead of the calling party for intra-office calls.</p> <p>Enter DDIDX, followed by a space, and datafill refinement DDIDX if a destination discount applies.</p>

ACCODE (continued)

Field descriptions for conditional datafill (Sheet 4 of 16)

Field	Subfield	Entry	Explanation and action
			<p>Enter DEST, followed by a space, and datafill refinement DEST if the destination is known.</p> <p>Enter DESTOM in order to associate a destination OM name with a particular destination.</p> <p>Enter DFT for DPNSS feature transparency functionality. Operates in conjunction with the QFT option (see later). QFT must be ON.</p> <p>Enter EXTCIC, followed by a space, and datafill refinements SOURCE, SKIPDIGS, and CICSIZE. EXTCIC is the external carrier identification code that indicates a long distance carrier in the global environment. This option is only supported for TOPS calls. For further information, refer to functionality Global Competitive Access, GOS00006.</p> <p>Enter IAA and the datafill refinement IAA_INDEX to generate or modify IAA message parameters based on datafill in table IAACtrl.</p> <p>Note: For the Japan market, if both the IAA and CLASS options are in use, IAA must precede CLASS in the datafill order.</p> <p>Enter LNET, followed by a space, and datafill refinement LNET if a logical network is required for metering.</p> <p>Enter MM, followed by a space, and datafill refinements MIN and MAX if the minimum and maximum dialed digits are known.</p> <p>Note: The Attendant Console does not abide by normal digit collection timers. When the max digits in translations have not been dialed, a ten second post dial delay (PDD) occurs. Long and short timers are ignored.</p> <p>Enter MZONE, followed by a space, and datafill refinement MZONE if metering is to be done on the call.</p>

ACCODE (continued)**Field descriptions for conditional datafill (Sheet 5 of 16)**

Field	Subfield	Entry	Explanation and action
			<p>Enter NETINFO to ensure that the customer group identifier and NCOS are transported to the terminating node to trigger the private IBN translations in a VPN. The private IBN translations are invoked only if options VPNXLT and IBNRX are datafilled at the terminating node.</p>
			<p>Enter NETSRV and datafill refinement NETSRV_NAME to indicate a Japan network service.</p>
			<p>Enter NICRF to activate the Network Identification Code (NIC) routing function.</p>
			<p>Enter NOANSTIM to the CONT selectors. This turns the T9 timer off in the outgoing ISUP trunk, if encountered.</p>
			<p>Enter NTAIO to mark the call destination.</p>
			<p>Enter NTAIT to mark the call destination.</p>
			<p>Enter OSS to indicate Operator Services Signaling is necessary. The OSS option does not have subfields.</p>
			<p>Enter PCC, followed by a space, and datafill refinement PCCDR if a pseudo country code is required.</p>
			<p>Enter PF, followed by a space, and datafill refinement PFDIGS if there are prefix digits in the digit stream.</p>
			<p>Enter PNRF to invoke the ported number recognition function.</p>
			<p>Enter PORTED to indicate that a previous node detected the service number of this call to have been ported.</p>
			<p>Enter PRESEL, followed by a space, if the call is to be treated as a preselected carrier case.</p>

ACCODE (continued)**Field descriptions for conditional datafill (Sheet 6 of 16)**

Field	Subfield	Entry	Explanation and action
			<p>Enter PRIVL, followed by a space, and datafill refinement PRIVL if the user is a privileged user (for example, operators).</p> <p>Enter QFT followed by ON or OFF to indicate if an outgoing route is capable of QSIG Feature Transparency.</p> <p>Note: The QFT ON option must not be added to a route unless the far-end node is QFT-capable.</p> <p>Enter SETCDN to trigger the setting of outgoing called party characteristics. This option assigns the called number name (CDNNAME) from table CDNCHAR to the call. If the CDNRTE option is subsequently encountered, the CDNNAME is used to route the call.</p> <p>You can use the SETCDN option to allow CDN routing when incoming agents such as DPNSS or BTUP are not available in table CDNCHAR.</p> <p>Enter TELETAXE. The TELETAXE option does not have subfields.</p> <p>Enter TOC, followed by a space, and datafill refinement CHG for the type of charge if the type of charge messaging is selected.</p> <p>Enter VPN, followed by a space, and datafill refinements ONNET and BILLABLE if the call routes through a service switching point (SSP) and the Australian VPN SSP feature is in the switching unit.</p> <p>Enter XLT, followed by a space, and datafill refinement XLASYS if the call is to proceed to another translation system.</p>

ACCODE (continued)**Field descriptions for conditional datafill (Sheet 7 of 16)**

Field	Subfield	Entry	Explanation and action
	ACF	0 to 29	Area code fence. If the entry in subfield OSEL is ACF, datafill this refinement. Enter the number of digits between the beginning of the digits to currently index the table, and the end of the area code.
	BILLABLE	Y or N	Virtual private network billable call. If the entry in subfield OSEL is VPN, datafill this refinement. Enter Y if an AMA record is required for each VPN call. Otherwise, enter N. An AMA record is not generated if an address complete message (ACM) of address complete—no charge is returned, or if the call terminates in the SSP on a line with the free number terminating (FNT) option.
	CALLCLASS	PRESELECT OVERRIDE, CALLTYPE, CSN,TRUNK	Call class. If the entry in subfield OSEL is PRESEL, enter PRESELECT to treat the DN as a preselected call. Enter OVERRIDE to permit the DN to use override codes. For charge category routing, enter CALLTYPE. Enter CSN to treat the DN as a carrier specific number. Enter TRUNK to permit access to trunk originated calls.

ACCODE (continued)**Field descriptions for conditional datafill (Sheet 8 of 16)**

Field	Subfield	Entry	Explanation and action
	CALLCTRL	CALLED, CALLING, LAST, or MUTUAL	<p>Call control. If the entry in subfield OSEL is CALLCTRL, datafill this refinement. Enter one of the following values to specify the party controlling the call:</p> <ul style="list-style-type: none"> • If the entry is CALLED and the called party goes on-hook first, the call is released immediately. If the calling line goes on-hook first and does not reanswer, the connection is not released until the called line goes on-hook. There are no time-outs, and the calling party is allowed to reanswer until the called line goes on-hook. <p>Calls to lines with option ESG must have CALLCTRL(CALLED).</p> <p>Calls terminating on an International Traffic Operator Position System (ITOPS) must have CALLCTRL (CALLED).</p> <ul style="list-style-type: none"> • If the entry is CALLING and the calling line goes on-hook first, the call is released immediately. If the called line goes on-hook first, the called party is allowed to reanswer within a datafilled reanswer time-out or until the calling line goes on-hook. If the time-out expires or if the calling line goes on-hook, the calling party releases the call and the called party is set to idle. <p>Call control (continued). Enter one of the following values to specify the party controlling the call:</p> <ul style="list-style-type: none"> • If the entry is LAST, the call is released when the later of the called party or the calling party goes on-hook. If either party goes on-hook, that party is allowed to reanswer within a datafilled reanswer time-out or until both parties go on-hook. • If the entry is MUTUAL and either line goes on-hook, the call is released immediately.

ACCODE (continued)**Field descriptions for conditional datafill (Sheet 9 of 16)**

Field	Subfield	Entry	Explanation and action
	CATRTE	CATRTE	Enter CATRTE to allow charge category routing in IBN translations.
	CDNNAME	alphanumeric string	If the entry in subfield OSEL is SETCDN, enter data for the CDNNAME refinement to allow CDN routing.
	CHG	SEND_CHARGE or SEND_NO_CHARGE	Charge. If the entry in subfield OSEL is TOC, datafill this refinement. Enter SEND_CHARGE to set the answer message (BTUP ANM) type of answer (TOA) string sent from a node to SEND_CHARGE. Enter SEND_NO_CHARGE to set the answer message (BTUP ANM) type of answer (TOA) string sent from a node to SEND_NO_CHARGE.
	CHGIND	ASIS, CHG, or NOCHG	If the entry in subfield OSEL is CHGIND, enter data for refinement CHGIND. The CHGIND refinement indicates whether to override the value of the charge indicator in the Backward Call indicators. Datafill the CHGIND field with the following values: <ul style="list-style-type: none"> • ASIS—treat charge indicator as is • CHG—treat charge indicator as charge • NOCHG—treat charge indicator as no charge
	CICSIZE	1 to 4	CIC size. If the entry in subfield OSEL is EXTCIC, datafill this refinement. This field indicates the number of digits in the CIC. This field operates on the B (called) number, so it is assumed that the CIC is signaled as part of the B number. The MAP display indicates the range is 0 to 4; however, the system does not allow 0.

ACCODE (continued)**Field descriptions for conditional datafill (Sheet 10 of 16)**

Field	Subfield	Entry	Explanation and action
	CLDFMT	CURRENT or POSTXLA	<p>Called format. If the entry in subfield OSEL is CAMA, enter either CURRENT or POSTXLA to produce the required ICAMA record format.</p> <p>If the entry is CURRENT, an ICAMA record is produced with the signaled DN (without translation).</p> <p>If the entry is POSTXLA, an ICAMA record is produced with a public switched telephone network (PSTN) number resulting from translations.</p>
	CLASS	ATT, CNTL, COLL, DATT, EMRG, IAGRP, ICNTL, INTL, IOPRA, LCL, NATL, OPRA, RURAL, SPEC, UNKW, or URBAN	<p>Translation CLASS. If the entry in subfield OSEL is CLASS, datafill this refinement. Enter the translation class determined by the dialed digits, as listed below. (This can be used for screening or billing purposes as described under CLASS in screening and charging options.)</p> <ul style="list-style-type: none"> • ATT (attendant console) • CNTL (continental) • COLL (collect) • DATT (dial attendant) • EMRG (emergency) • IAGRP (interagent group) • ICNTL (intercontinental) • INTL (international) • IOPRA (international operator assisted) • LCL (local) • NATL (national) • OPRA (operator assisted) • RURAL (rural) • SPEC (special) • UNKW (unknown) • URBAN (urban)

ACCODE (continued)**Field descriptions for conditional datafill (Sheet 11 of 16)**

Field	Subfield	Entry	Explanation and action
	CLIOVRD	CNA, CNB	If the entry in subfield OSEL is CLIOVRD, enter data for the CLIOVRD refinement to block or allow delivery of a calling line identity for each call. Enter CNA (calling number allowed) or CNB (calling number blocked).
	CONDIGS	0 to 29 digits	Consumed digits. If the entry in subfield OSEL is CONSUME, datafill this refinement. Enter a number to explicitly define the number of digits consumed during call processing.
	CONTINUE	CONT or NOCONT	Continue. If the entry in subfield OSEL is PRESEL, enter CONT to continue translations through UXLA. Enter NOCONT to immediately route translations through PCIXLA or PCITRK.
	CPMCALL	Y or N	Called party metering. If the entry in subfield OSEL is CPMCALL, datafill this refinement. Enter Y (yes) if calls are billed against the called party for intra-office calls. Enter N (no) for the default value of billing against the calling party for intraoffice calls.
	DDIDX	1 to 63 or DEFAULT	Destination discount index. If the entry in subfield OSEL is DDIDX, datafill this refinement. Enter the destination discount index number, which is an index in table AOCOPT.
	DEST	0 to 1023	Destination route list index. If the entry in subfield OSEL is DEST, datafill this refinement. Enter the number in the route list of the translation system that the call is routed to.
	DESTOM	Destination OM names that are datafilled in table TERMINFO (16 character vector).	Destination and route based OMs. If the entry in subfield OSEL is DESTOM, datafill this refinement.

ACCODE (continued)**Field descriptions for conditional datafill (Sheet 12 of 16)**

Field	Subfield	Entry	Explanation and action
	IAA_INDEX	0 to 1024	Interadministration accounting index. If the entry in subfield OSEL is IAA, datafill this refinement. Enter the value that indexes the corresponding tuple in table IAACTRL.
	LNET	alphanumeric (1 to 8 characters)	Logical network. If the entry in subfield OSEL is LNET, datafill this refinement. Enter the logical network name that the call is on. The logical network name must be previously datafilled in table LNETWORK. The entry in this field is used by the international metering system to determine a tariff for the call.
	MAX	0 to 30	Maximum digits. If the entry in subfield OSEL is MM, datafill this refinement. Enter the maximum number of digits expected. This value includes the digits used to index the current tuple and must also include the prefix digits specified in the current tuple.
	MIN	0 to 30	Minimum digits. If the entry in subfield OSEL is MM, datafill this refinement. Enter the minimum number of digits expected. This value includes the digits used to index the current tuple and must also include the prefix digits specified in the current tuple.
	MZONE	0 to 63	Metering zone. If the entry in subfield OSEL is MZONE, datafill this refinement. Enter the metering zone of the call, in the logical network as defined by selector LNET. The entry in this field is an index (DESTZONE) in table MDESTIDX.

ACCODE (continued)**Field descriptions for conditional datafill (Sheet 13 of 16)**

Field	Subfield	Entry	Explanation and action
	NETSRV_ NAME	IPHS, DPHS, MOBILE, DA, TELEGRAM, or NCC	<p>Network service name. If the entry in subfield OSEL is NETSRV, datafill this refinement. The entry in this field determines the parameters in an outgoing IAM message.</p> <p>Enter IPHS to indicate a call to an independent personal handyphone system subscriber.</p> <p>Enter DPHS to indicate a call to a dependent personal handyphone system subscriber.</p> <p>Enter MOBILE to indicate a call to a mobile subscriber.</p> <p>Enter DA to indicate a call to the directory assistance operator.</p> <p>Enter TELEGRAM to indicate a call to the Telegram office.</p> <p>Enter NCC to indicate a call routed to one of the following networks:</p> <ul style="list-style-type: none"> • New Common Carrier serving international toll traffic • New Common Carrier serving national toll traffic
	NICRF	NICRF	<p>NIC routing function. This option allows transit calls prefixed with the NIC to access table PNINFO to route the call based on the NIC. Note that the NICRF and PNRF options are incompatible and cannot be datafilled on the same tuple.</p>
	NOA	INTL, LOCAL, NATL, or NET	<p>Nature of address. Enter the required called party nature of address as follows:</p> <ul style="list-style-type: none"> • INTL (international) • LOCAL (local) • NATL (national) • NET (Intelligent Network Services)

ACCODE (continued)

Field descriptions for conditional datafill (Sheet 14 of 16)

Field	Subfield	Entry	Explanation and action
	ONNET	Y or N	<p>Call on virtual private network. If the entry in subfield OSEL is VPN, datafill this refinement. Enter Y if the call stays within the defined virtual private network. Otherwise, enter N.</p> <p>Overlapped outpulsing is supported only on off-network calls. Calls processed without subfield ONNET set to Y are off-network calls. Meridian Digital Centrex (MDC) calls are treated as off-network calls, and therefore overlapped outpulsing is supported for MDC calls.</p>
	PCCDR	0 to 9, B, C, D, E (1 to 3 digits)	<p>Pseudo country code digits. If the entry in subfield OSEL is PCC, datafill this refinement. Enter the three-digit pseudo country code (PCC). If a two-digit PCC is required, it must be padded by a leading zero.</p> <p>The pseudo country code is used to record a particular pseudo country code. This can be extracted for use by system logic later, for example, two-stage outpulsing.</p>
	PFDIGS	0 to 24	<p>Number of prefix digits. If the entry in subfield OSEL is PF, datafill this refinement. Enter the number of prefix digits. If prefix digits are identified in a previous table, this number is added to the existing value. Prefix digits are not used to index any further translation tables and are not outpulsed, but they do remain stored in call detail records (CDR).</p> <p>Note: If refinements PF and CONSUME are both datafilled for the same tuple, only the entry for the greater of the two values is processed; the other entry is ignored.</p>
	PFXAMA	0 to 4 digits or N	<p>Called party number prefix in AMA. If NOA is set to NTL, datafill PFXAMA with 0011.</p> <p>If NOA is set to NATL, datafill PFXAMA with 0.</p> <p>If NOA is set to LOCAL or NET, datafill PFXAMA with N.</p>

ACCODE (continued)**Field descriptions for conditional datafill (Sheet 15 of 16)**

Field	Subfield	Entry	Explanation and action
	PNRF	PNRFOPTS	Ported number recognitions function. Datafill the PNRFOPTS options vector and the INSNG subfields:
	INSNG	See subfields PREFIX and TRUNK_ACCESS_DIG	
	PREFIX	0 to 11	PREFIX indicates the number of leading digits to be copied from an originator's DN and prefixed to the translating number.
	TRUNK_ACCESS_DIG	0 to 9, or N	TRUNK_ACCESS_DIG enables the specification of a trunk access digit to be prefixed to the translating number after the INSNG_PREFIX function has been completed.
	PORTED	PORTED or blank	Number portability indicator. This entry indicates that the service number for this call has been ported.
	PRIVL	Y or N	Privileged user. If the entry in subfield OSEL is PRIVL, datafill this refinement. Enter Y (yes), if the user is a privileged user (for example, operator). Otherwise, enter N (no).
	SKIPDIGS	0 to 24	Skip digits. If the entry in subfield OSEL is EXTCIC, datafill this refinement. This field indicates the number of digits to skip before extracting the carrier digits from the digit stream. This field operates on the B (called) number, so it is assumed that the CIC is signaled as part of the B number.
	SOURCE	PRESUB or DIALED	Carrier identification code source. If the entry in subfield OSEL is EXTCIC, datafill this refinement. This field specifies the source of the CIC as follows: <ul style="list-style-type: none"> • PRESUB—presubscribed. The CIC is defined in table TRKGRP • DIALED—dialed. The CIC is entered by the subscriber when dialing a call

ACCODE (continued)**Field descriptions for conditional datafill (Sheet 16 of 16)**

Field	Subfield	Entry	Explanation and action
	STOPRTMR	Y or N	Stop remote timer. Enter Y to disable the address complete message (ACM) timer of the remote switch. The default value is N.
	XLAID	FREE, GENERIC1, GENERIC2, GENERIC3	AMA translation identifier. If the entry in subfield OSEL is AMAXLAID, datafill this refinement. Enter the AMA translation identifier to be used against table AMAXLAID.
	XLASYS	AC, AM, CT, FA, FT, NSC, OFC, PX	<p>Translation system. If the entry in subfield OSEL is XLT, datafill this refinement. Enter the next translation system to use, followed by a space, then datafill refinement XLANAME. Enter one of the following:</p> <ul style="list-style-type: none"> • AC (access) • AM (ambiguous) • CT (country) • FA (foreign area) • FT (utility) • NSC (number service code) • OFC (office) • PX (prefix) <p>Note: NIL is not a valid entry. NIL is used only to satisfy internal software functionality. NSC is not used in GL03.</p>
	XLANAME	alphanumeric (1 to 8 characters)	Translation name. If the entry in subfield OSEL is XLT, datafill this refinement. Enter the translation name of the table within the XLASYS to which the call is routed.

ACCODE (continued)**XLASEL = DBQ**

If the entry in field XLASEL is DBQ, datafill the following refinements.

Field descriptions for conditional datafill (Sheet 1 of 2)

Field	Subfield	Entry	Explanation and action
	OPT	see subfield	Options. This field is a vector consisting of up to ten options. Each option consists of subfield OSEL, and refinements that depend on the entry in subfield OSEL. For each option, specify the option selector (OSEL), followed by a space, then the refinements, each separated by a space. The entry is concluded by a \$. Datafill continues with field DFOP.
	OSEL	MM, NSC, or PF	Option selector. The following options can be selected: Enter MM, followed by a space, and datafill refinements MIN and MAX, if the minimum and maximum dialed digits are known. Enter NSC, followed by a space, and datafill refinement NSCODE, if a number service code operation is to be performed on a call. Enter PF, followed by a space, and datafill refinement PFDIGS if there are prefix digits in the digit stream.
	MAX	0 to 30	Maximum digits. If the entry in subfield OSEL is MM, datafill this refinement. Enter the maximum number of digits expected. This value includes the digits used to index the current tuple and must also include the prefix digits specified in the current tuple.
	MIN	0 to 30	Minimum digits. If the entry in subfield OSEL is MM, datafill this refinement. Enter the minimum number of digits expected. This value includes the digits used to index the current tuple and must also include the prefix digits specified in the current tuple.

ACCODE (continued)**Field descriptions for conditional datafill (Sheet 2 of 2)**

Field	Subfield	Entry	Explanation and action
	NSCODE	AIN, 800P, E008, E800, MAP_HLR, MAP_MSC, MAP_VLR, PVN, MAPHLR, REPLDIGS, or VPN	<p>Number service code. If the entry in subfield OSEL is NSC, enter the required number service code for the operation to be performed on the call, as follows:</p> <ul style="list-style-type: none"> • AIN (advanced intelligent network) • 800P (800+) • E008 (Enhanced 008) • E800 (Enhanced 800) • MAP_HLR (mobile application part home location register) • MAP_MSC (mobile application part mobile service switching center) • MAP_VLR (mobile application part visitor location register) • MAPHLR (appears only if the MAP Interworking to BTUP feature is present on the switch) • PVN (private virtual network) • REPLDIGS (replace digits) • VPN (Australian virtual private network)
	PFDIGS	0 to 24	<p>Number of prefix digits. If the entry in subfield OSEL is PF, datafill this refinement. Enter the number of prefix digits. If prefix digits are identified in a previous table, this number is added to the existing value. Prefix digits are not used to index any further translation tables and are not outpulsed, but they do remain stored in call detail records (CDR).</p>

XLASEL = DMOD

If the entry in subfield XLASEL is DMOD, datafill the following refinements.

If options CDNRTE and CPCRTE are both present in one tuple in table xxCODE, call processing accesses routing tables in the following order: table CPCUXLA is accessed first. If no match is found, table CDNUXLA is accessed next.

ACCODE (continued)

If options SETCDN and CDNRTE are both present in one tuple in table xxCODE, call processing accesses table CDNUXLA first, before the SETCDN option sets the called number name (CDNNAME).

Field descriptions for conditional datafill (Sheet 1 of 9)

Field	Subfield	Entry	Explanation and action
	OPT	see subfield	Options. This field is a vector consisting of up to ten options. Each option consists of subfield OSEL, and refinements that depend on the entry in subfield OSEL. For each option, specify the option selector (OSEL), followed by a space, and the refinements, each separated by a space. The entry is concluded by a \$. Datafill continues with field DFOP.
	OSEL	AFTER, CATRTE, CDNRTE, CGNDM, CHGIND, CONSUME, COODM, CPCRTE, DEL, DESTOM, EXTCIC, INSRT, PF, RBP, REPL, SETCDN, VPNREPL, VPNXLT, or XLT	<p>Option selector. The following options can be selected:</p> <p>Enter AFTER, followed by a space, and datafill refinement AFTER if a certain number of digits must be skipped before modifying the digit stream.</p> <p>Enter CATRTE to allow charge category routing in IBN translations.</p> <p>Enter CDNRTE to route using the called number name (CDNNAME) from table CDNCHAR. If the CDNNAME is present on the incoming call or is set by the SETCDN option, translation proceeds to table CDNUXLA.</p> <p>Enter CGNDM, followed by a space, and datafill refinements PREFXCLI and INSRTCLI to remove digits from the calling line identification (CLI) and insert a datafilled digit string of up to five digits in the prefix string. The total length of the CLI and the digit string can be up to 18 digits. A modified CLI and digit string of more than 18 digits routes the call to treatment.</p>

ACCODE (continued)**Field descriptions for conditional datafill (Sheet 2 of 9)**

Field	Subfield	Entry	Explanation and action
			<p>Enter CONSUME, followed by a space, and datafill refinement CONDIGS to specify the number of digits that are consumed during translation.</p> <p>Enter COODM, followed by a space, and datafill refinement SERVICE to replace the dialed emergency code by the emergency number stored in table LAC.</p> <p>Note: Option selector COODM must be combined with option XLT to guarantee that translation continues with the modified number. Selector COODM cannot be combined with any other option.</p> <p>Enter CPCRTE to route using the calling party category (CPCNAME) from table CPCCHAR. If the CPCNAME is present on the incoming call, translation proceeds to table CPCUXLA.</p> <p>Enter DEL, followed by a space, and datafill refinement DELDIGS. Further digits are accepted from the agent, and overlapped outpulsing is not affected. Digits being deleted are processed before those being inserted.</p> <p>Enter DESTOM in order to associate a destination OM name with a particular destination.</p> <p>Enter EXTCIC, followed by a space, and datafill refinements SOURCE, SKIPDIGS, and CICSIZE. EXTCIC is the external carrier identification code that indicates a long distance carrier in the global environment. This option is only supported for TOPS calls. For further information, refer to functionality Global Competitive Access, GOS00006.</p>

ACCODE (continued)

Field descriptions for conditional datafill (Sheet 3 of 9)

Field	Subfield	Entry	Explanation and action
			<p>Enter INSRT, followed by a space, and datafill refinement INSRDIGS. Further digits are accepted from the agent, and overlapped outpulsing is not affected. Digits being deleted are processed before those being inserted.</p> <p>Note: Digit insertion is done in the actual digit stream, and the changes are reflected in call detail records. Replacement and insertion cannot be datafilled in the same tuple. If both options are datafilled, the second option in the tuple is used.</p> <p>Enter PF, followed by a space, and datafill refinement PFDIGS, if there are prefix digits in the digit stream.</p> <p>Enter RBP without refinements. The entry RBP is used when a call is to be marked as Ringback Price. The RBP entry in table ACCODE suffixes a hexadecimal E to the calling digits for a call that translates using a tuple with option RBP.</p> <p>Enter REPL and datafill refinement REPLDIGS. Overlapped outpulsing is disabled, and all digits are collected before continuing.</p> <p>Note: Digit replacement occurs in the actual digit stream, and the changes are reflected in call detail records. Replacement and insertion cannot be datafilled in the same tuple. If both options are datafilled, the second option in the tuple is used.</p>

ACCODE (continued)

Field descriptions for conditional datafill (Sheet 4 of 9)

Field	Subfield	Entry	Explanation and action
			<p>Enter SETCDN to trigger the setting of outgoing called party characteristics. This option assigns the called number name (CDNNAME) from table CDNCHAR to the call. If the CDNRTE option is subsequently encountered, the CDNNAME is used to route the call.</p> <p>You can use the SETCDN option to allow CDN routing when incoming agents such as DPNSS or BTUP are not available in table CDNCHAR.</p> <p>Enter VPNREPL to replace the called party digits with the VPN called party digits conveyed across the public network by the QSIG Feature Transparency mechanism.</p> <p>Enter VPNXLT to replace the current translation system and translator name with the values stored in table BGIDMAP. The entry to table BGIDMAP is addressed by the NNI BGID and SIGNIFICANCE information received in the originating signaling for the call.</p> <p>Note: The VPNXLT and XLT options must not both exist in the same tuple.</p> <p>Enter XLT, followed by a space, and datafill refinement XLASYS if the call proceeds to another translation system.</p>

ACCODE (continued)

Field descriptions for conditional datafill (Sheet 5 of 9)

Field	Subfield	Entry	Explanation and action
	AFTER	0 to 29	<p>After. If the entry in subfield OSEL is AFTER, datafill this refinement. Enter the number of digits to skip before doing the modification. The default case is to calculate the new prefix fence, and replace, insert, or delete digits after the fence (for example, starting at the next digit). Option AFTER is an additional number of digits to skip before doing the modification. Option AFTER refers to the option datafilled immediately before it. For example:</p> <p>>DMOD DEL 3 AFTER 2 INSRT 11</p> <p>skips two digits, deletes the next three, and inserts digits 11 at the beginning of the digit string. The result when applied to 234567 is 23117.</p> <p>Note: Datafilling this refinement with 0 (the default value), displays the following error message:</p> <pre>Too few digits for AFTER UNSUPPORTED OPTION AT: # PROCESSING ERROR UNEXPECTED ERROR CONDITION</pre>
	CATRTE	CATRTE	Enter CATRTE to allow charge category routing in IBN translations.
	CDNNAME	alphanumeric string	If the entry in subfield OSEL is SETCDN, enter data for the CDNNAME refinement to allow CDN routing.

ACCODE (continued)**Field descriptions for conditional datafill (Sheet 6 of 9)**

Field	Subfield	Entry	Explanation and action
	CHGIND	ASIS, CHG, or NOCHG	<p>If the entry in subfield OSEL is CHGIND, enter data for refinement CHGIND. The CHGIND refinement indicates whether to override the value of the charge indicator in the Backward Call indicators.</p> <p>Datafill the CHGIND field with the following values:</p> <ul style="list-style-type: none"> • ASIS—treat charge indicator as is • CHG—treat charge indicator as charge • NOCHG—treat charge indicator as no charge
	CICSIZE	1 to 4	<p>CIC size. If the entry in subfield OSEL is EXTCIC, datafill this refinement. This field indicates the number of digits in the CIC. This field operates on the B (called) number, so it is assumed that the CIC is signaled as part of the B number.</p> <p>The MAP display indicates the range is 0 to 4; however, the system does not allow 0.</p>
	CONDIGS	numeric (0 to 29 digits)	<p>Consumed digits. If the entry in subfield OSEL is CONSUME, datafill this refinement. Enter a number to explicitly define the number of digits consumed during call processing.</p>
	DELDIGS	0 to 29	<p>Delete digits. If the entry in subfield OSEL is DEL, datafill this refinement. Enter the number of digits to be deleted, after skipping digits to be left unprocessed.</p>
	DESTOM	Destination OM names that are datafilled in table TERMINFO (16 character vector).	<p>Destination and route based OMs. If the entry in subfield OSEL is DESTOM, datafill this refinement.</p>

ACCODE (continued)**Field descriptions for conditional datafill (Sheet 7 of 9)**

Field	Subfield	Entry	Explanation and action
	INSRDIGS	numeric (0 to 29 digits)	Insert digits. If the entry in subfield OSEL is INSRT, datafill this refinement. Enter the digits to be inserted, after skipping digits to be left unprocessed.
	INSRTCLI	1 to 5 digits or \$	Insert calling line identification. If the entry in subfield OSEL is CGNDM, datafill this refinement. Enter the new string to insert as the prefix onto the CLI. Enter \$ to specify that no digit string is inserted.
	PFDIGS	0 to 24	Number of prefix digits. If the entry in subfield OSEL is PF, datafill this refinement. Enter the number of prefix digits. If prefix digits are identified in a previous table, this number is added to the existing value. Prefix digits are not used to index any further translation tables and are not outpulsed, but they do remain stored in call detail records (CDR). Note: If refinements PF and CONSUME are both datafilled for the same tuple, only the entry for the greater of the two values is processed; the other entry is ignored.
	PREFXCLI	0 to 18	Prefix calling line identification. If the entry in subfield OSEL is CGNDM, datafill this refinement. Enter the number of prefix digits to delete.
	REPLDIGS	numeric (0 to 30 digits)	Replace digits. If the entry in subfield OSEL is REPL, datafill this refinement. Enter the digits that replace the existing digits, after skipping digits to be left unprocessed.
	SERVICE	alphanumeric (1 to 8 characters)	COODM service. If the entry in subfield OSEL is COODM, datafill this refinement. Enter the emergency service name. Emergency service names are listed in field EMRGSERV in table LAC.

ACCODE (continued)**Field descriptions for conditional datafill (Sheet 8 of 9)**

Field	Subfield	Entry	Explanation and action
	SKIPDIGS	0 to 24	Skip digits. If the entry in subfield OSEL is EXTCIC, datafill this refinement. This field indicates the number of digits to skip before extracting the carrier digits from the digit stream. This field operates on the B (called) number, so it is assumed that the CIC is signaled as part of the B number.
	SOURCE	PRESUB or DIALED	Carrier identification code source. If the entry in subfield OSEL is EXTCIC, datafill this refinement. This field specifies the source of the CIC as follows: <ul style="list-style-type: none"> • PRESUB—presubscribed. The CIC is defined in table TRKGRP. • DIALED—dialed. The CIC is entered by the subscriber when dialing a call.

ACCODE (continued)**Field descriptions for conditional datafill (Sheet 9 of 9)**

Field	Subfield	Entry	Explanation and action
	XLASYS	AC, AM, CT, FA, FT, NSC, OFC, or PX	<p>Translation system. If the entry in subfield OSEL is XLT, datafill this refinement. Enter the next translation system to use, followed by a space, and datafill subfield XLANAME (the instance of the translation system).</p> <p>The choice of translation systems is as follows:</p> <ul style="list-style-type: none"> • AC (access) • AM (ambiguous) • CT (country) • FA (foreign area) • FT (utility) • NSC (number service code) • OFC (office) • PX (prefix) <p>Note: NIL is not a valid entry. NIL is used only to satisfy internal software functionality. NSC is not used in GL03.</p>
	XLANAME	alphanumeric (1 to 8 characters)	<p>Translation name. If the entry in subfield OSEL is XLT, datafill this refinement. Enter the translation name of the table within the XLASYS to which the call is routed.</p>

XLASEL = DNRTE

If the entry in subfield XLASEL is DNRTE, datafill the following refinements. Selector DNRTE allows translation to continue in table DNINV. Through this translation, calls can be terminated at directory numbers (DN) datafilled in table DNINV.

After datafilling table ACHEAD, table DNINV must be datafilled before selector DNRTE is datafilled in table ACCODE.

ACCODE (continued)

Table AMAXLAID must be datafilled prior to selecting option AMAXLAID in field OSEL.

Field descriptions for conditional datafill (Sheet 1 of 4)

Field	Subfield	Entry	Explanation and action
	OPT	see subfield	Options. This field is a vector consisting of up to ten options. Each option consists of subfield OSEL and refinements that depend on the entry in subfield OSEL. For each option, specify the option selector (OSEL), followed by a space, and the refinements, each separated by a space. The entry is concluded by a \$. Datafill continues with field DFOP.
	OSEL	AMAXLAID, CAMA, CLASS, DN, MM, PF, SF, or ALLOWOVLP	<p>Option selector. The following options can be selected:</p> <p>Enter ALLOWOVLP to allow call routing based on MIN digits instead of MAX. The ALLOWOVLP option does not have subfields.</p> <p>Enter AMAXLAID, followed by a space, and datafill refinement XLAID to specify an automatic message accounting (AMA) identity from within table AMAXLAID.</p> <p>Enter CAMA, followed by a space, and datafill refinement CLDFMT. The entry in CLDFMT indicates whether the international centralized AMA (ICAMA) record is generated with the originally signaled DN or the final public switched telephone network (PSTN) number.</p> <p>Enter CLASS, followed by a space, and datafill refinement CLASS if the class of the dialed digits is determined.</p> <p>Enter DN, followed by a space, and datafill refinements SNPA and OFC for the DN that the call is routed to.</p> <p>Enter MM, followed by a space, and datafill refinements MIN and MAX if the minimum and maximum dialed digits are known.</p>

ACCODE (continued)**Field descriptions for conditional datafill (Sheet 2 of 4)**

Field	Subfield	Entry	Explanation and action
			<p>Enter PF, followed by a space, and datafill refinement PFDIGS if there are prefix digits in the digit stream.</p> <p>Enter SF, followed by a space, and datafill refinement SFDIGS to indicate the beginning of the station code digits.</p>
	CLDFMT	CURRENT or POSTXLA	<p>Called format. If the entry in subfield OSEL is CAMA, enter either CURRENT or POSTXLA to produce the required ICAMA record format.</p> <p>If the entry is CURRENT, an ICAMA record is produced with the signaled DN (without translation).</p> <p>If the entry is POSTXLA, an ICAMA record is produced with the public switched telephone network (PSTN) number resulting from translations.</p>

ACCODE (continued)**Field descriptions for conditional datafill (Sheet 3 of 4)**

Field	Subfield	Entry	Explanation and action
	CLASS	ATT, CNTL, COLL, DATT, EMRG, IAGRP, ICNTL, INTL, IOPRA, LCL, NATL, OPRA, RURAL, SPEC, UNKW, or URBAN	<p>Translation class. If the entry in subfield OSEL is CLASS, datafill this refinement. Enter the translation class determined by the dialed digits. This can be used for screening or billing purposes as described under CLASS in screening and charging options.</p> <ul style="list-style-type: none"> • ATT (attendant console) • CNTL (continental) • COLL (collect) • DATT (dial attendant) • EMRG (emergency) • IAGRP (interagent group) • ICNTL (intercontinental) • INTL (international) • IOPRA (international operator assisted) • LCL (local) • NATL (national) • OPRA (operator assisted) • RURAL (rural) • SPEC (special) • UNKW (unknown) • URBAN (urban)
	OFC	numeric (1 to 7 digits)	Seven-digit office code. If the entry in subfield OSEL is DN, enter the office code for the DN that the call is routed to.
	MAX	0 to 30	Maximum digits. If the entry in subfield OSEL is MM, datafill this refinement. Enter the maximum number of digits expected. This value includes the digits used to index the current tuple and must also include the prefix digits specified in the current tuple.

ACCODE (continued)**Field descriptions for conditional datafill (Sheet 4 of 4)**

Field	Subfield	Entry	Explanation and action
	MIN	0 to 30	Minimum digits. If the entry in subfield OSEL is MM, datafill this refinement. Enter the minimum number of digits expected. This value includes the digits used to index the current tuple and must also include the prefix digits specified in the current tuple.
	OFC	numeric (1 to 7 digits)	Seven-digit office code. If the entry in subfield OSEL is DN, enter the office code for the DN that the call is routed to.
	OFC	numeric (1 to 7 digits)	Seven-digit office code. If the entry in subfield OSEL is DN, enter the office code for the DN that the call is routed to.
	PFDIGS	0 to 24	Number of prefix digits. If the entry in subfield OSEL is PF, datafill this refinement. Enter the number of prefix digits. If prefix digits are identified in a previous table, this number is added to the existing value. Prefix digits are not used to index any further translation tables and are not outpulsed, but they do remain stored in call detail records (CDR).
	SFDIGS	0 to 29	Station fence digits. If the entry in subfield OSEL is SF, datafill this refinement. Enter a number to indicate the number of digits to advance past the start of the digits that index into the tuple. During call processing, the station code digits consist of all digits beyond this indicator to the end of the dialed digits. If option SF is not datafilled, the last four digits are used as the station code.
	SNPA	000 to 999 (3 digits)	Serving number plan area. If the entry in subfield OSEL is DN, enter the required serving number plan area (SNPA). This number must be datafilled in table HNPACONT or in table SNPANAME.
	XLAID	FREE, GENERIC1, GENERIC2, GENERIC3	AMA translation identifier. If the entry in subfield OSEL is AMAXLAID, enter the AMA translation identifier to be used against table AMAXLAID.

ACCODE (continued)**XLASEL = FEAT**

If the entry in field XLASEL is FEAT, datafill the following refinements.

Field descriptions for conditional datafill (Sheet 1 of 3)

Field	Subfield	Entry	Explanation and action
	OPT	see subfield	Options. This field is a vector consisting of up to ten options. Each option consists of subfield OSEL, and refinements that depend on the entry in subfield OSEL. For each option, specify the option selector (OSEL), followed by a space, and the refinements, each separated by a space. The entry is concluded by a \$. Datafill continues with field DFOP.
	OSEL	FTR, FUNC, MM, or PF	<p>Option selector. The following options can be selected:</p> <p>Enter FTR, followed by a space, and datafill refinement FTR to identify the international line feature.</p> <p>Enter FTR, followed by a space, and datafill refinement VSC to indicate that the international line feature needs translation in table XLA.</p> <p>Enter FUNC, followed by a space, and datafill refinement FUNC to identify the international line feature function.</p> <p>Enter MM, followed by a space, and datafill refinements MIN and MAX if the minimum and maximum dialed digits are known.</p> <p>Enter PF, followed by a space, and datafill refinement PFDIGS if there are prefix digits in the digit stream.</p>

ACCODE (continued)**Field descriptions for conditional datafill (Sheet 2 of 3)**

Field	Subfield	Entry	Explanation and action
	FTR	CALLBACK, CALLCHAR, CCBS,CLCT DIGS, FOC, FTD, FTR, JES, NTC, TLC, VALIDATE, VMWI, or VSC	<p>Feature name. If the entry in subfield OSEL is FTR, enter an international line feature name shown below.</p> <ul style="list-style-type: none"> • CALLBACK (Call Back) • CALLCHAR (Call Characters) • CCBS (Call Completion to Busy Subscriber) for CEPT • CLCTDIGS (Collect Digits) • FOC (Faultsman Line Open Circuit Test) • FTD (Faultsman Digit Test) • FTR (Faultsman Ring Back) • JES (Japan Emergency Service) • NTC (Notify Time Charges) • TLC (Trunk Logic Circuit) • VALIDATE (not used in GL03) • VMWI (Voice Mail Waiting Indication) • VSC (Vertical service code)
	FUNC	ACT, DEACT, DELETE, INTER, PROG, or USAGE	<p>Feature function code. If subfield OSEL is set to FUNC, enter one of the international line feature function codes from the following list:</p> <ul style="list-style-type: none"> • ACT (activate) • DEACT (deactivate) • DELETE (delete) • INTER (interrogate) • PROG (programming) • USAGE (usage)
	MAX	0 to 30	<p>Maximum digits. If the entry in subfield OSEL is MM, datafill this refinement. Enter the maximum number of digits expected following MIN entry and a space. This value includes the digits used to index the current tuple and must also include the prefix digits specified in the current tuple.</p>

ACCODE (continued)**Field descriptions for conditional datafill (Sheet 3 of 3)**

Field	Subfield	Entry	Explanation and action
	MIN	0 to 30	Minimum digits. If the entry in subfield OSEL is MM, datafill this refinement. Enter the minimum number of digits expected. This value includes the digits used to index the current tuple and must also include the prefix digits specified in the current tuple.
	PFDIGS	0 to 24	Number of prefix digits. If the entry in subfield OSEL is PF, datafill this refinement. Enter the number of prefix digits. If prefix digits are identified in a previous table, this number is added to the existing value. Prefix digits are not used to index any further translation tables and are not outputted, but they remain stored in call detail records (CDR).

XLASEL = FEATINFO

If the entry in subfield XLASEL is FEATINFO, datafill the following refinements. Selector FEATINFO makes use of table DNSCRN to store information against DNs, which is used during call processing to determine how to proceed with the call. The screening function is triggered by selector

ACCODE (continued)

FEATINFO in the universal translation tables. The options available with this selector are shown below.

Field descriptions for conditional datafill (Sheet 1 of 11)

Field	Subfield	Entry	Explanation and action
	FTR	CALLBACK, CALLCHAR, CLCTDIGS, JES, NTC, PATH_REPL ACEMENT TLC, VALIDATE, or VMWI	<p>Feature name. Enter CALLBACK to enable originator callback during translations. Datafill subfield CALLBACK_OPTION and its refinements, then datafill subfields PFDIGS, MINDIGS, MAXDIGS, and TABREF.</p> <p>Enter CALLCHAR to modify all signaling characteristics. Datafill subfields CLLCHROP, ISPPRFIND, ACMCGIND, ANMCGIND, ISPRELCS, PFDIGS, MINDIGS, MAXDIGS, and TABREF.</p> <p>Enter CLCTDIGS to collect digits from the call originator and add them to the called digits stream for translation. Datafill subfields CLDGMIN, CLDGMAX, CLCTDIGS_OPTION, PFDIGS, MINDIGS, MAXDIGS, and TABREF.</p> <p>Enter JES to activate the Japan Emergency Service feature. Datafill refinements PFDIGS and TABREF.</p> <p>Enter NTC to notify the originating subscriber of applicable time and charges after the call terminates. Datafill subfield SUBOPT_NAME and its refinement, then datafill subfields PFDIGS, MINDIGS, MAXDIGS, and TABREF.</p> <p>Enter PATH_REPLACEMENT for translations to terminate on the Path Replacement feature.</p> <p>Enter TLC to enable the test line call feature, which provides audible ringback tone followed by dial tone after specified durations. Datafill subfields RING_BACK_TONE_DUR, DIAL_TONE_DUR, TLC_PREFIX_DIGS, TLC_NUM_DIGS, and TLC_CHARGE.</p>

ACCODE (continued)**Field descriptions for conditional datafill (Sheet 2 of 11)**

Field	Subfield	Entry	Explanation and action
			Enter VALIDATE, and datafill subfield VALADTOP and its refinements. Datafill subfields PFDIGS, MINDIGS, MAXDIGS, and TABREF.
			Enter VMWI, followed by a space, and enter data for subfields STATUS, VMDN, or PFDIG. This command routes message waiting or cleared indication calls to the VMWI.
	CALLBACK_OPTION	CLCTDEST or NIL	Callback option. If the entry in field FTR is CALLBACK, datafill this option. Enter CLCTDEST to call back the subscriber and collect destination digits. Datafill subfields CLDGMIN, CLDGMAX, DISC_ANNC_TRK, PROMPT_ANNC_TRK, and SEND_ANM. Otherwise, enter NIL.
	CLDGMIN	1 to 24	Minimum collected digits. Enter the minimum number of digits to be collected and entered into the called digit stream.
	CLDGMAX	1 to 24	Maximum collected digits. Enter maximum number of digits to be collected and written into the called digit stream. The value cannot be less than CLDGMIN.
	DISC_ANNC_TRK	alphanumeric (1 to 16 characters)	Disconnect announcement trunk. Enter trunk common language location identifier (CLLI).
	PROMPT_ANNC_TRK	alphanumeric (1 to 16 characters)	Prompt announcement trunk. Enter trunk the common language location identifier (CLLI).
	SEND_ANM	Y or N	Send answer message. Enter Y (yes) or N (no).

ACCODE (continued)**Field descriptions for conditional datafill (Sheet 3 of 11)**

Field	Subfield	Entry	Explanation and action
	CLLCHROP	NOCHGMSG or EARLYCPG	<p>Call characteristics. If the entry in field FTR is CALLCHAR, datafill this option.</p> <p>Enter NOCHGMSG to block backward CHG message.</p> <p>Enter EARLYCPG to specify that a call progress (CPG) message is issued in the backwards direction before an address complete message (ACM) is sent. The CPG message is permitted before an ACM in certain ISDN user part (ISUP) variants to establish a bidirectional speech path and to stop the T7 timer.</p>
	ISPPRFIND	See Explanation and action	<p>ISUP preference indicator.</p> <p>Enter ISDN_UP_PREF_ALL_THE_WAY if ISUP is the preferred signalling system for the whole connection.</p> <p>Enter ISDN_UP_PREF_NOT_REQD if ISUP is not required.</p> <p>Enter ISDN_UP_REQD_ALL_THE_WAY if ISUP is the required signalling system for the whole connection.</p> <p>ISDN_PREF_SPARE is a spare value.</p>
	ACMCGIND	See Explanation and action	<p>ACM charge indicator. This field specifies the charge indication in the BCI parameter of the ACM message.</p> <p>Enter CI_NO_INDICATION for no charge indication.</p> <p>Enter CI_NO_CHARGE if no charging is to be done at this node.</p> <p>Enter CI_CHARGE if charging is to be done at this node.</p> <p>CI_SPARE is a spare value.</p>

ACCODE (continued)**Field descriptions for conditional datafill (Sheet 4 of 11)**

Field	Subfield	Entry	Explanation and action
	ANMCGIND	See Explanation and action	<p>ANM charge indicator. This field specifies the charge indication in the BCI parameter of the ANM message</p> <p>Enter CI_NO_INDICATION for no charge indication.</p> <p>Enter CI_NO_CHARGE if no charging is to be done at this node.</p> <p>Enter CI_CHARGE if charging is to be done at this node.</p> <p>CI_SPARE is a spare value.</p>
	ISPRELCS	See Explanation and action	<p>ISUP release cause. This field specifies the cause location in the cause indicator parameter of the REL (release) message.</p> <p>Enter USER to specify the user.</p> <p>Enter PRIVNET to specify a private switch serving the local user.</p> <p>Enter LOCLNET to specify a public switch serving the local user.</p> <p>Enter TRANSNET to specify a transit switch.</p> <p>Enter RLOCNET to specify a public switch serving the remote user.</p> <p>Enter RPRIVNET to specify a private switch serving the remote user.</p> <p>Enter LICBS to specify a local interface controlled by a signaling link.</p> <p>Enter INTLNET to specify an international switch.</p> <p>SP1 is a spare value.</p> <p>SP2 is a spare value.</p> <p>Enter UNKNOWN to specify an unknown location.</p> <p>Enter NIL for no location.</p>
	CLCTDIGS_OPTION	NIL or \$	<p>Collect digits option. If the entry in field FTR is CLCTDIGS, datafill this option. Enter NIL or enter \$ to proceed to the next option.</p>

ACCODE (continued)**Field descriptions for conditional datafill (Sheet 5 of 11)**

Field	Subfield	Entry	Explanation and action
	SUBOPT_ NAME	DUR_ADJ	Suboption name. If the entry in field FTR is NTC, datafill this option. Enter DUR_ADJ to specify the duration adjustment for NTC and datafill subfield DURATION_ADJ.
	DURATION_ ADJ	0 to 99	Duration adjustment. Enter the time in seconds.
	RING_BACK_ TONE_DUR	1 to 255	Ringback tone duration. If the entry in field FTR is TLC, datafill this option. Enter the time, in seconds, that ringback tone is provided to the originator.
	DIAL_TONE_ DUR	1 to 255	Dial tone duration. If the entry in field FTR is TLC, datafill this option. Enter the time, in seconds, that dial tone is provided to the originator.
	TLC_PREFIX_ DIGS	0 to 18	Prefix digits in called number. If the entry in field FTR is TLC, datafill this option. Enter the number of digits to advance the prefix fence to detect the charge message digits when CPC = PAYPHONE.
	TLC_NUM_ DIGS	numeric (3 or 4) Japan only	Test line call number of digits. Enter the number of dialed digits to be transferred to the NCCI#7 CHG message. This is also the number of digits stored in the LMNNUM field of the SMDR #DE record.
	TLC_CHARGE	Y or N	Test line call charge indicator. The TLC_CHARGE field indicates the billing status of an ISUP test call. Enter Y if the call is billable. Enter N if the call is not billable. The default value for this field is N.

ACCODE (continued)**Field descriptions for conditional datafill (Sheet 6 of 11)**

Field	Subfield	Entry	Explanation and action
	OPT	see subfield VALDATOP	Options. If the entry in field FTR is VALIDATE, datafill this option. This field is a vector consisting of up to five options. Each option consists of subfield VALDATOP, and refinements that depend on the entry in subfield VALDATOP. For each option, specify VALDATOP, followed by a space, then the refinements, each separated by a space. The entry is concluded by a \$ and datafill continues with field DFOP.
	VALDATOP	BCSCRN, CALLED, CLDTCCLG, CLISERV CUSTMOD, LCASCRN, NOCHARGE, PRESEL, SCRNLNTH, SUBSCRN, TCNOTSCR, THIRDPTY, VERDEST, V3PTYBIL	<p>Validate option. Enter a list of up to five options. The options specify what characteristics are to be considered when screening the call. Enter \$ to signify the end of the list.</p> <p>Note: Selector VALIDATE is traversed only once for each call.</p> <p>Enter BCSCRN and datafill refinement BCOPTS to identify the bearer capability name.</p> <p>Enter CALLED to indicate the number to be used for screening. The SUBSCRN options are used to specify the subscriber types allowed to receive the call.</p> <p>Note: When using option CALLED, there must be no further digit manipulation after selector VALIDATE is encountered in translations.</p> <p>If option CALLED is not entered, then the calling party number is used for screening and the SUBSCRN options are used to specify the subscriber types allowed to make the call.</p> <p>Note: Pay phone subscribers are treated as general subscribers if option CALLED is specified.</p>

ACCODE (continued)**Field descriptions for conditional datafill (Sheet 7 of 11)**

Field	Subfield	Entry	Explanation and action
			<p>Enter CLDTCOLG, followed by a space, to copy digits from the called to the calling digit stream, and datafill options OFFSET and COUNT.</p> <p>Enter CLISERV, followed by a space, and enter data for subfield SERVNAME. The CLISERV field indicates the name of the client server.</p> <p>Enter CUSTMOD, followed by a space, to alter the internal network class of service (NCOS) and customer group to new value for a given directory number (DN) based on the CUSTINFO attribute in table DNSCRN. The source of the DN used as an index into table DNSCRN is determined by the VALIDATE datafill. Datafill refinement CUSTSCRN.</p> <p>Enter LCASCRN, followed by a space, to enable local calling area screening. The called and calling numbers are checked against tables LCARNAME and LCASCRCN to determine if the numbers are local to each other, and whether the call should be denied or allowed to continue routing.</p> <p>Enter NOCHARGE, followed by a space, to indicate that the call is nonbillable.</p> <p>Note: If both NOCHARGE and THIRDPTY options are specified, NOCHARGE takes precedence.</p> <p>Enter PRESEL to allow screening for the PRESEL attribute in table DNSCRN.</p> <p>Enter SCRNLNTH, followed by a space, and datafill refinement MINLNTH to specify the minimum length of the number being screened.</p>

ACCODE (continued)

Field descriptions for conditional datafill (Sheet 8 of 11)

Field	Subfield	Entry	Explanation and action
			<p>Enter SUBSCRN, followed by a space, and datafill up to three multiples of the following subscriber types: GENERAL, PAYPHONE, PERSONAL, and MOBILE. Enter \$ after entering SUBSCRN to indicate that no subscriber types are permitted to make or receive the call.</p> <p>Enter TCNOTSCR to indicate that calls with CPC set to Test Call are not screened.</p> <p>Enter THIRDPPTY to indicate that automatic third party billing is used. Table DNSCRN is checked for attribute UNPAID.</p> <p>Note: If both NOCHARGE and THIRDPPTY options are specified, NOCHARGE takes precedence.</p> <p>Note: Payphone subscribers are treated as general subscribers if option CALLED is specified.</p> <p>Enter VERDEST to verify the destination of a call. Called digits are checked against ADDCODE entries in table DNSCRN.</p> <p>Note: NIL appears on the switch range but is not a valid entry. The value NIL is used only to satisfy internal software requirements.</p>
	STATUS	WAITING or CLEARED	<p>VMWI status type Enter WAITING for message waiting indication.</p> <p>Enter CLEARED for message cleared indication.</p>
	VMDN	numeric0 to 18 digits	Digit register. Enter the voice mail DN used to retrieve messages from the voice platform. The DN can contain up to 18 digits.
	PFDIG	numeric,0 to 24 digits	Extended digit count. Enter the subscriber's DN.

ACCODE (continued)**Field descriptions for conditional datafill (Sheet 9 of 11)**

Field	Subfield	Entry	Explanation and action
	BCOPTS	alphanumeric (1 to 8 characters)	Bearer capability option. If the entry in field VALDATOP is BCSCRN, datafill this refinement. Enter up to four bearer capability names.
	COUNT	0 to 13	If the entry in field VALDATOP is CLDTCCLG, enter data for this refinement. Enter a maximum of 13 digits for the called to calling number.
	CUSTSCRN	Y or N	Customer screen. Enter Y to block calls that are not subscribed to the switched on-net services if attempting a switched on-net call. If the DN being screened is not present in table DNSCRN, the call is rejected with the Call Not Allowed (CNAD) treatment. The internal NCOS and CUSTGRP associated with the call are altered to the values found in the CUSTINFO attribute if present for the given DN in table DNSCRN. The DN used to index table DNSCRN can be the subscriber calling line identification (CLI) or the dialed number. The source of the DN is determined by the datafill of field VALIDATE. Enter N if no screening is performed.
Note: The FEATINFO values CCANN, CCARD, CCSDT, DAFOP, FAXSUP, FAXTEST, INBFAX, INBFD, INTLFD, ISD, ISDTST, ISDVRE, OUTBFAX, OUTBFD, PB3RDPTY, PBCALL, PBISD, PBISDVRE, and PBTST are valid only in DMS-250 switching offices. Additional DMS-250 parameters are listed in the DMS-250 specific data schema NTPs.			
	MINLNTH	0 to 18values from 0 to 30 are possible in APC software loads	Minimum length. If the entry in field VALDATOP is SCRNLNTH, enter the minimum number of digits required in number being screened.
	OFFSET	0 to 30	If the entry in field VALDATOP is CLDTCCLG, enter data for this refinement. Enter a maximum of 30 digits.
	SERVNAME	alphanumeric string	If the entry in field VALDATOP is CLISERV, enter data for this refinement. Enter the name of a client server.

ACCODE (continued)**Field descriptions for conditional datafill (Sheet 10 of 11)**

Field	Subfield	Entry	Explanation and action
	SUBSCTYP	GENERAL, PAYPHONE, PERSONAL, or MOBILE	Subscriber type. Enter subscriber type, followed by a space, and datafill refinements WHITLIST, CHKBLKCL, CHKUNPD, and CHKCCR. This option allows you to specify which subscriber types are permitted to make or receive a call and whether the subscriber's standing is important for a call.
	WHITLIST	Y or N	Whether it list. Enter Y (yes) to indicate that the subscriber's directory number must be datafilled in table DNSCRN. Otherwise, enter N (no).
	CHKBLKCL	Y or N	Check block call. Enter Y to check if the subscriber has subscribed to all services for which this tuple is being used (BLKCALL attribute in table DNSCRN). Otherwise, enter N.
	CHKUNPD	Y or N	Check unpaid. Enter Y to check if the subscriber has paid his bills. Otherwise, enter N.
	CHKCCR	Y or N	Check cumulative call restriction. Enter Y to check the subscriber's cumulative charge limit. Otherwise, enter N.
	PFDIGS	0 to 24	Prefix digits. Enter the number of prefix digits present at this point in the call. Prefix digits are not used to index any further translation tables and are not outpulsed, but they remain stored in call detail records (CDR).
	MINDIGS	0 to 30	Minimum digits. Enter the minimum number of digits expected. This value includes the digits used to index the current tuple and must also include the prefix digits specified in the current tuple.
	MAXDIGS	0 to 30	Maximum digits. Enter the maximum number of digits expected. This value includes the digits used to index the current tuple and must also include the prefix digits specified in the current tuple.

ACCODE (continued)**Field descriptions for conditional datafill (Sheet 11 of 11)**

Field	Subfield	Entry	Explanation and action
	TABREF	see subfields	Table reference. This field consists of subfields XLASYS and XLANAME.
	XLASYS	AC, AM, CT, FA, FT, NSC, OFC, or PX	<p>Translation system. Enter the next translation system to use, followed by a space, and datafill subfield XLANAME (the instance of the translation system).</p> <p>The choice of translation systems is as follows:</p> <ul style="list-style-type: none"> • AC (access) • AM (ambiguous) • CT (country) • FA (foreign area) • FT (utility) • NSC (number service code) • OFC (office) • PX (prefix) <p>Note: NIL is not a valid entry. NIL is used only to satisfy internal software functionality.</p>
	XLANAME	alphanumeric (1 to 8 characters)	Translation name. Enter the translation name of the table instance within the XLASYS to which the call is routed.

ACCODE (continued)**XLASEL = HRC**

If the entry in subfield XLASEL is HRC, datafill the following refinements.

Field descriptions for conditional datafill (Sheet 1 of 2)

Field	Subfield	Entry	Explanation and action
	OPT	see subfield	Options. This field contains subfield OSEL, and refinements that depend on the entry in subfield OSEL. The entry is concluded by a \$ and datafill continues with field DFOP.
	OSEL	XLT, PFBILL	Option selector. If the call proceeds to another translation system, enter XLT, followed by a space, and datafill refinement XLASYS. Also complete an entry for option selector PFBILL.
	XLASYS	AC, AM, CT, FA, FT, NSC, OFC, PX	<p>Translation system. If option selector XLT is entered in subfield OSEL, datafill this refinement. Enter the next translation system to use, followed by a space, then datafill refinement XLANAME. Enter one of the following:</p> <ul style="list-style-type: none"> • AC (access) • AM (ambiguous) • CT (country) • FA (foreign area) • FT (utility) • NSC (number service code) • OFC (office) • PX (prefix) <p>Note: NIL is not a valid entry. NIL is used only to satisfy internal software functionality. NSC is not used in GL03.</p>

ACCODE (continued)**Field descriptions for conditional datafill (Sheet 2 of 2)**

Field	Subfield	Entry	Explanation and action
	XLANAME	alphanumeric (1 to 8 characters)	Translation name. If XLT is entered in subfield OSEL, datafill this refinement. Enter the translation name of the table within the XLASYS to which the call is routed.
	PFBILL	Y or N	Prefix billing option. Enter PFBILL, followed by a space, and then enter either Y or N. If Y is entered, the home routing code specified in the tuple is included in the billing record. If N is entered, the home routing code is not included in billing records.

XLASEL = IAC

If the entry in subfield XLASEL is IAC, datafill the following refinements.

Field descriptions for conditional datafill

Field	Subfield	Entry	Explanation and action
	OPT	see subfield	Options. This field is a vector list consisting of up to ten options. Each option consists of subfield OSEL, and refinements that depend on the entry in subfield OSEL. The entry is concluded by a \$ and datafill continues with field DFOP.
	OSEL	PF	Option selector. Enter PF, followed by a space, and datafill refinement PFDIGS if there are prefix digits in the digit stream.
	PFDIGS	0 to 24	Number of prefix digits. If the entry in subfield OSEL is PF, datafill this refinement. Enter the number of prefix digits. If prefix digits are identified in a previous table, this number is added to the existing value. Prefix digits are not used to index any further translation tables and are not outputted, but they remain stored in call detail records (CDR).

XLASEL = RTE

If the entry in subfield XLASEL is RTE, datafill the following refinements.

Table AMAXLAID must be datafilled prior to selecting option AMAXLAID in field OSEL.

ACCODE (continued)

If options `CDNRTE` and `CPCRTE` are both present in one tuple in table `xxCODE`, call processing accesses routing tables in the following order: table `CPCUXLA` is accessed first. If no match is found, table `CDNUXLA` is accessed next.

If options `SETCDN` and `CDNRTE` are both present in one tuple in table `xxCODE`, call processing accesses table `CDNUXLA` first, before the `SETCDN` option sets the called number name (`CDNNAME`).

ACCODE (continued)

Conditional datafill for XLASEL = RTE is shown in the table below.

ACCODE (continued)**Field descriptions for conditional datafill (Sheet 1 of 16)**

Field	Subfield or refinement	Entry	Explanation and action
	OPT	see subfield	Options. This field is a vector consisting of a maximum of ten options. Each option consists of subfield OSEL, and refinements that depend on the entry in subfield OSEL. For each option, specify the option selector (OSEL), followed by a space and the refinements, each separated by a space. The entry is concluded by a \$. Datafill continues with field DFOP.
	OSEL	ACF, AMAXLAID, BLKOVLP, CALLCTRL, CAMA, CATRTE, CDN, CDNRTE, CHGIND, CLASS, CONSUME, CPCRTE, CPMCALL, DDIDX, DEST, DESTOM, DFT, EXTCIC, IAA, LNET, MM, MZONE, NETINFO, NETSRV, NICRF, NOANSTIM, NTAIO, NTAIT, PCC, PF, PIP, PORTED, PNRF, PRESEL, PRESELRTE PRIVL, QFT, SETCDN, TELETAXE, TOC, VPN, or VPNPAN	Option selector. The following options can be selected: Enter ACF, followed by a space, and datafill refinement ACF if the area code fence is defined. Enter AMAXLAID, followed by a space, and datafill refinement XLAID to specify an automatic message accounting (AMA) identity from within table AMAXLAID. Enter BLKOVLP, followed by a space, and datafill refinement XLADATA, to prevent calls from being outpulsed until all CDN digits are collected. Enter CALLCTRL, followed by a space, and datafill refinement CALLCTRL. The entry in refinement CALLCTRL indicates who has control of the call: the calling party, the called party, or both.

ACCODE (continued)**Field descriptions for conditional datafill (Sheet 2 of 16)**

Field	Subfield or refinement	Entry	Explanation and action
			<p>Enter CAMA, followed by a space, and datafill refinement CLDFMT. The entry in refinement CLDFMT indicates whether the international centralized automatic message accounting (ICAMA) record is generated with either the originally signaled directory number (DN) or the final public switched telephone network (PSTN) number.</p> <p>Enter CATRTE to allow charge category routing in IBN translations.</p> <p>Enter CDN, followed by a space, and datafill refinement CDN to select the nature of address field. This field is used to identify the called party of the initial address message (IAM). It is used for Australian ISDN user part (AISUP) call translations.</p> <p>Enter CDNRTE to route using the called number name (CDNNAME) from table CDNCHAR. If the CDNNAME is present on the incoming call or is set by the SETCDN option, translation proceeds to table CDNUXLA. The CDNRTE option does not apply to table AMCODE.</p> <p>Enter CHGIND, followed by a space, and enter data for refinement CHGIND. This field indicates if the system applies a charge against the call.</p> <p>Enter CLASS, followed by a space, and datafill refinement CLASS if the class of the dialed digits is determined.</p> <p>Note: For the Japan market, if both the CLASS and IAA options are in use, IAA must precede CLASS in the datafill order.</p> <p>Enter CONSUME, followed by a space, and datafill refinement CONDIGS to specify the number of digits that are consumed during translation.</p>

ACCODE (continued)**Field descriptions for conditional datafill (Sheet 3 of 16)**

Field	Subfield or refinement	Entry	Explanation and action
			<p>Enter CPCRTE to route using the calling party category (CPCNAME) from table CPCCHAR. If the CPCNAME is present on the incoming call, translation proceeds to table CPCUXLA. The CPCRTE option does not apply to table AMCODE.</p> <p>Enter CPMCALL, followed by a space, and datafill refinement CPMCALL to specify call billing against the called party instead of the calling party for intraoffice calls.</p> <p>Enter DDIDX, followed by a space, and datafill refinement DDIDX if a destination discount applies.</p> <p>Enter DEST, followed by a space, and enter data for refinement DEST. Enter data for the field if the destination is known.</p> <p>Enter DESTOM in order to associate a destination OM name with a particular destination.</p> <p>Enter DFT for DPNSS feature transparency functionality. Operates in conjunction with the QFT option (see later). QFT must be ON.</p> <p>Enter EXTCIC, followed by a space, and datafill refinements SOURCE, SKIPDIGS, and CICSIZE. EXTCIC is the external carrier identification code that indicates a long distance carrier in the global environment. This option is only supported for TOPS calls. For further information, refer to functionality Global Competitive Access, GOS00006.</p> <p>Enter IAA and the datafill refinement IAA_INDEX to generate or modify IAA message parameters based on datafill in table IAACtrl.</p> <p>Note: For the Japan market, if both the IAA and CLASS options are in use, IAA must precede CLASS in the datafill order.</p>

ACCODE (continued)**Field descriptions for conditional datafill (Sheet 4 of 16)**

Field	Subfield or refinement	Entry	Explanation and action
			<p>Enter LNET, followed by a space, and datafill refinement LNET if a logical network is required for metering.</p> <p>Enter MM, followed by a space, and datafill refinements MIN and MAX if the minimum and maximum number of expected digits dialed are known. These values include the digits used to index the current tuple and must also include the prefix digits specified in the current tuple.</p> <p>Note: For fast interdigital timing to function properly, MM can only be used with the RTE selector whenever the value in refinement MIN is not equal to the value in refinement MAX. In other words, if MIN=MAX, MM can be used with the CONT selector in table PXC CODE; if the value in refinement MIN is not equal to the value in refinement MAX, MM cannot be used until the RTE selector is used (which is usually in either table FACODE or table OFCCODE). If refinements MIN and MAX are set in table PXC CODE when they are not equal to each other, partial dial timing is used after MIN digits are dialed to determine the end of dialing.</p> <p>Enter MZONE, followed by a space, and datafill refinement MZONE if metering is done on the call.</p> <p>Enter NETINFO to ensure that the customer group identifier and NCOS are transported to the terminating node to trigger the private IBN translations in a VPN. The private IBN translations are invoked only if options VPNXLT and IBNRX are datafilled at the terminating node.</p> <p>Enter NETSRV and datafill refinement NETSRV_NAME to indicate a Japan network service.</p>

ACCODE (continued)**Field descriptions for conditional datafill (Sheet 5 of 16)**

Field	Subfield or refinement	Entry	Explanation and action
			<p>Enter NICRF to activate the Network Identification Code (NIC) routing function.</p> <p>Enter NOANSTIM, to the RTE selectors. This turns the T9 timer off in the outgoing ISUP trunk, if encountered.</p> <p>Enter NTAIO to mark the call destination.</p> <p>Enter NTAIT to mark the call destination.</p> <p>Enter PCC, followed by a space, and datafill refinement PCCDR if a pseudo country code is required.</p> <p>Enter PF, followed by a space, and datafill refinement PFDIGS, the prefix fence. This is the number of prefix digits associated with this tuple (that is, if some prefix digits were identified in a previous table, the number here is added to the existing value). Prefix digits are not used to index any further translation tables and are not outpulsed, but they remain stored in call detail records (CDR).</p> <p>Enter PNRF to invoke the ported number recognition function. Datafill the PNRFOPTS options vector and associated subfields.</p> <p>Enter PIP, followed by a space, to perform a residency check for the digits being translated. The residency check is used by the local number portability feature to ensure that calls to DNs which have been ported in to the office are not routed out of the office.</p> <p>Note: You must complete entries in fields MIN and MAX before entering the PIP option.</p> <p>Enter PORTED to indicate that a previous node detected the service number of this call to have been ported.</p> <p>Enter PRESEL, followed by a space, if the call is to be treated as a preselected carrier case.</p>

ACCODE (continued)**Field descriptions for conditional datafill (Sheet 6 of 16)**

Field	Subfield or refinement	Entry	Explanation and action
			<p>Enter PRESEL RTE, followed by a space, and datafill refinement PRESEL RTE, the index into the route table of the current XLASYS and XLANAME.</p> <p>Enter PRIVL, followed by a space, and datafill refinement PRIVL if the user is a privileged user (for example, operators).</p> <p>Enter QFT followed by ON or OFF to indicate if an outgoing route is capable of QSIG Feature Transparency.</p> <p>Note: The QFT ON option must not be added to a route unless the far-end node is QFT-capable.</p> <p>Enter SETCDN to trigger the setting of outgoing called party characteristics. This option assigns the called number name (CDNNAME) from table CDNCHAR to the call. If the CDNRTE option is subsequently encountered, the CDNNAME is used to route the call.</p> <p>You can use the SETCDN option to allow CDN routing when incoming agents such as DPNSS or BTUP are not available in table CDNCHAR.</p> <p>Enter TOC, followed by a space, and datafill refinement CHG for the type of charge where the type of charge messaging is to be selected.</p> <p>Enter VPN, followed by a space, and datafill refinements ONNET and BILLABLE if the call routes through a service switching point (SSP) and the Australian VPN-SSP feature is present on the switch.</p>

ACCODE (continued)**Field descriptions for conditional datafill (Sheet 7 of 16)**

Field	Subfield or refinement	Entry	Explanation and action
			Enter VPNPAN to indicate that the PINX is to act as the PAN for an outgoing route. Note: If VPNREPL or VPNXLT have been entered in the DMOD selector, the VPNPAN option is ignored.
	ACF	0 to 29	Area code fence. If the entry in subfield OSEL is ACF, datafill this refinement. Enter the number of digits between the beginning of the digits to index the table, and the end of the area code.
	BILLABLE	Y or N	Virtual private network billable call. If the entry in subfield OSEL is VPN, enter Y if an automatic message accounting (AMA) record is required for each VPN call. Otherwise, enter N. An AMA record is not generated if an address complete message (ACM) of address complete, no charge is returned, or if the call terminates in the SSP on a line with the free number terminating (FNT) option.
	CALLCLASS	PRESELECT OVERRIDE, CALLTYPE, CSN, TRUNK	Call class. If the entry in subfield OSEL is PRESEL, enter PRESELECT to treat the DN as a preselected call. Enter OVERRIDE to permit the DN to use override codes. For charge category routing enter CALLTYPE. Enter CSN to treat the DN as a carrier specific number. Enter TRUNK to permit access to trunk originated calls. CALLCLASS does not apply to Global loads.

ACCODE (continued)**Field descriptions for conditional datafill (Sheet 8 of 16)**

Field	Subfield or refinement	Entry	Explanation and action
	CALLCTRL	CALLED, CALLING, LAST, or MUTUAL	<p>Call control. If the entry in subfield OSEL is CALLCTRL, datafill this refinement. Enter one of the following values to specify the party controlling the call:</p> <ul style="list-style-type: none"> • If the entry is CALLED and the called line goes on-hook first, the call is released immediately. If the calling line goes on-hook first and does not reanswer, the connection is not released until the called line goes on-hook. There are no time-outs, and the calling party is allowed to reanswer until the called line goes on-hook. Calls to lines with option ESG must have CALLCTRL(CALLED). Calls terminating on an ITOPS position must have CALLCTRL(CALLED). • If the entry is CALLING and the calling line goes on-hook first, the call is released immediately. If the called line goes on-hook first, the called party is allowed to reanswer within a datafilled reanswer time-out or until the calling line goes on-hook. If the time-out expires or if the calling line goes on-hook, the calling party releases the call and the called line is set to idle. • If the entry is LAST, the call is released when the later of the called party or the calling party goes on-hook. If either party goes on-hook, that party is allowed to reanswer within a datafilled reanswer time-out or until both parties go on-hook. • If the entry is MUTUAL and either line goes on-hook, the call is released immediately.
	CATRTE	CATRTE	Enter CATRTE to allow charge category routing in IBN translations.
	CDNNAME	alphanumeric string	If the entry in subfield OSEL is SETCDN, enter data for the called number name (CDNNAME).

ACCODE (continued)**Field descriptions for conditional datafill (Sheet 9 of 16)**

Field	Subfield or refinement	Entry	Explanation and action
	CHG	SEND_ CHARGE or SEND_NO_ CHARGE	<p>Charge. If the entry in subfield OSEL is TOC, enter SEND_CHARGE to set the answer message (BTUP ANM) type of answer (TOA) string sent from a node to SEND_CHARGE.</p> <p>Enter SEND_NO_CHARGE to set the answer message (BTUP ANM) type of answer (TOA) string sent from a node to SEND_NO_CHARGE.</p>
	CHGIND	CHARGE or NO_CHARGE	If the entry in subfield OSEL is CHIND, enter data for refinement CHGIND. This refinement determines if the system applies a charge to the call.
	CICSIZE	1 to 4	<p>CIC size. If the entry in subfield OSEL is EXTCIC, enter data for this refinement. This field indicates the number of digits in the CIC. This field operates on the B (called) number, so it is assumed that the CIC is signaled as part of the B number.</p> <p>The MAP display indicates the range is 0 to 4; however, the system does not allow 0.</p>
	CLDFMT	CURRENT or POSTXLA	<p>Called format. If the entry in subfield OSEL is CAMA, enter either CURRENT or POSTXLA to produce the required ICAMA record format.</p> <p>If the entry is CURRENT, an ICAMA record is produced with the signaled DN (without translation).</p> <p>If the entry is POSTXLA, an ICAMA record is produced with a PSTN number resulting from translations.</p>

ACCODE (continued)**Field descriptions for conditional datafill (Sheet 10 of 16)**

Field	Subfield or refinement	Entry	Explanation and action
	CLASS	ATT, CNTL, COLL, DATT, EMRG, IAGRP, ICNTL, INTL, IOPRA, LCL, NATL, OPRA, RURAL, SPEC, UNKW, or URBAN	<p>Translation class. If the entry in subfield OSEL is CLASS, enter the translation class determined by the dialed digits. This can be used for screening or billing as described under CLASS in screening and charging options.</p> <p>The translation classes are defined as follows:</p> <ul style="list-style-type: none"> • ATT (attendant console) • CNTL (continental) • COLL (collect) • DATT (dial attendant) • EMRG (emergency) • IAGRP (interagent group) • ICNTL (intercontinental) • INTL (international) • IOPRA (international operator assisted) • LCL (local) • NATL (national) • OPRA (operator assisted) • RURAL (rural) • SPEC (special) • UNKW (unknown) • URBAN (urban)
	CONDIGS	numeric (0 to 29 digits)	Consumed digits. If the entry in subfield OSEL is CONSUME, datafill this refinement. Enter a number to explicitly define the number of digits consumed during call processing.
	CONTINUE	CONT or NOCONT	Continue. If the entry in subfield OSEL is PRESEL, enter CONT to continue translations through universal translations. Enter NOCONT to immediately route translations through PCIXLA or PCITRK.

ACCODE (continued)**Field descriptions for conditional datafill (Sheet 11 of 16)**

Field	Subfield or refinement	Entry	Explanation and action
	CPMCALL	Y or N	Called party metering. If the entry in subfield OSEL is CPMCALL, enter Y (yes) if calls are billed against the called party for intraoffice calls. Enter N (no) for the default value of billing against the calling party for intraoffice calls.
	DDIDX	1 to 63 or DEFAULT	Destination discount index. If the entry in subfield OSEL is DDIDX, datafill this refinement. Enter the destination discount index number, which is an index into table AOCOPT.
	DEST	0 to 1023	Destination route list index. If the entry in subfield OSEL is DEST, enter the number in the route list of the translation system that the call is routed to.
	DESTOM	Destination OM names that are datafilled in table TERMINFO (16 character vector).	Destination and route based OMs. If the entry in subfield OSEL is DESTOM, datafill this refinement.
	IAA_INDEX	0 to 1024	Interadministration accounting index. If the entry in subfield OSEL is IAA, datafill this refinement. Enter the value that indexes the corresponding tuple in table IAACRRL.
	LNET	alphanumeric (1 to 8 characters)	Logical network. If the entry in subfield OSEL is LNET, enter the logical network name that the call is on. The logical network name must be previously datafilled in table LNETWORK. The entry in this field is used by the international metering system to determine a tariff for the call.

ACCODE (continued)**Field descriptions for conditional datafill (Sheet 12 of 16)**

Field	Subfield or refinement	Entry	Explanation and action
	MAX	0 to 30	Maximum digits. If the entry in subfield OSEL is MM, datafill this refinement. Enter the maximum number of digits expected. This value includes the digits used to index the current tuple and must also include the prefix digits specified in the current tuple.
	MIN	0 to 30	Minimum digits. If the entry in subfield OSEL is MM, datafill this refinement. Enter the minimum number of digits expected. This value includes the digits used to index the current tuple and must also include the prefix digits specified in the current tuple.
	MZONE	0 to 63	Metering zone. If the entry in subfield OSEL is MZONE, datafill this refinement. Enter the metering zone of the call, in the logical network as defined by selector LNET. The entry in this field is an index (DESTZONE) in table MDESTIDX.

ACCODE (continued)**Field descriptions for conditional datafill (Sheet 13 of 16)**

Field	Subfield or refinement	Entry	Explanation and action
	NETSRV_ NAME	IPHS, DPHS, MOBILE, DA, TELEGRAM, or NCC	<p>Network service name. If the entry in subfield OSEL is NETSRV, datafill this refinement. The entry in this field determines the parameters in an outgoing IAM message.</p> <p>Enter IPHS to indicate a call to an independent personal handyphone system subscriber.</p> <p>Enter DPHS to indicate a call to a dependent personal handyphone system subscriber.</p> <p>Enter MOBILE to indicate a call to a mobile subscriber.</p> <p>Enter DA to indicate a call to the directory assistance operator.</p> <p>Enter TELEGRAM to indicate a call to the Telegram office.</p> <p>Enter NCC to indicate a call routed to one of the following networks:</p> <ul style="list-style-type: none"> • New Common Carrier serving international toll traffic • New Common Carrier serving national toll traffic
	NICRF	NICRF	<p>NIC routing function. This option allows transit calls prefixed with the NIC to access table PNINFO to route the call based on the NIC. Note that the NICRF and PNRF options are incompatible and cannot be datafilled on the same tuple.</p>
	NOA	INTL, LOCAL, NATL, or NET	<p>Nature of address. Enter the required called party nature of address:</p> <ul style="list-style-type: none"> • INTL (international) • LOCAL (local) • NATL (national) • NET (Intelligent Network Services)

ACCODE (continued)**Field descriptions for conditional datafill (Sheet 14 of 16)**

Field	Subfield or refinement	Entry	Explanation and action
	ONNET	Y or N	<p>Call on virtual private network. If the entry in subfield OSEL is VPN, enter Y if the call stays within the defined virtual private network. Otherwise, enter N.</p> <p>Overlapped outpulsing is supported only on off-network calls. Calls processed without subfield ONNET set to Y are off-network calls. Meridian Digital Centrex (MDC) calls are treated as off-network calls, and therefore overlapped outpulsing is supported for MDC calls.</p>
	PCCDR	0 to 9, B, C, D, E (1 to 3 digits)	<p>Pseudo country code digits. If the entry in subfield OSEL is PCC, enter the three-digit pseudo country code (PCC). If a two-digit PCC is required, it must be padded by a leading zero.</p> <p>The pseudo country code is used to record a particular pseudo country code. This can be extracted for use by system logic later, for example, two-stage outpulsing.</p>
	PFDIGS	0 to 24	<p>Number of prefix digits. If the entry in subfield OSEL is PF, datafill this refinement. Enter the number of prefix digits. If prefix digits are identified in a previous table, this number is added to the existing value. Prefix digits are not used to index any further translation tables and are not outpulsed, but they remain stored in call detail records (CDR).</p> <p>Note: If refinements PF and CONSUME are both datafilled for the same tuple, the entry for the greater of the two values is processed; the other entry is ignored.</p>
	PFXAMA	0 to 4 digits or N	<p>Called party number prefix in AMA. If NOA is set to NTL, datafill PFXAMA with 0011.</p> <p>If NOA is set to NATL, datafill PFXAMA with 0.</p> <p>If NOA is set to LOCAL or NET, datafill PFXAMA with N.</p>

ACCODE (continued)**Field descriptions for conditional datafill (Sheet 15 of 16)**

Field	Subfield or refinement	Entry	Explanation and action
	PORTED	PORTED or blank	Number portability indicator. This entry indicates that the service number for this call has been ported.
	PNRF	PNRFOPTS	Ported number recognitions function. Datafill the PNRFOPTS options vector and the INSNG subfields:
	INSNG	See subfields PREFIX and TRUNK_ACCESS_DIGS	
	PREFIX	0 to 11	PREFIX indicates the number of leading digits to be copied from an originator's DN and prefixed to the translating number.
	TRUNK_ACCESS_DIG	0 to 9, or N	TRUNK_ACCESS_DIG enables the specification of a trunk access digit to be prefixed to the translating number after the INSNG_PREFIX function has been completed.
	PRIVL	Y or N	Privileged user. If the entry in subfield OSEL is PRIVL, enter Y (yes), if the user is a privileged user (for example, operator). Otherwise, enter N (no).
	SKIPDIGS	0 to 24	Skip digits. If the entry in subfield OSEL is EXTCIC, datafill this refinement. This field indicates the number of digits to skip before extracting the carrier digits from the digit stream. This field operates on the B (called) number, so it is assumed that the CIC is signaled as part of the B number.
	SOURCE	PRESUB or DIALED	Carrier identification code source. If the entry in subfield OSEL is EXTCIC, datafill this refinement. This field specifies the source of the CIC as follows: <ul style="list-style-type: none"> • PRESUB—presubscribed, the CIC is defined in table TRKGRP • DIALED—dialed, the CIC is entered by the subscriber when dialing a call

ACCODE (continued)**Field descriptions for conditional datafill (Sheet 16 of 16)**

Field	Subfield or refinement	Entry	Explanation and action
	STOPRTMR	Y or N	Stop remote timer. Enter Y (yes) to disable the address complete message (ACM) timer of the remote switch. The default value is N (no).
	XLAID	FREE, GENERIC1, GENERIC2, GENERIC3	AMA translation identifier. If the entry in subfield OSEL is AMAXLAID, enter the AMA translation identifier to be used against table AMAXLAID.

XLASEL = TRMT

If the entry in subfield XLASEL is TRMT, datafill the following refinements.

Route to the specified treatment. A treatment is a known exception or failure condition. The action taken terminates translation, returning an indication that a treatment was encountered and decoded into a route.

Field descriptions for conditional datafill (Sheet 1 of 2)

Field	Subfield or refinement	Entry	Explanation and action
	OPT	see subfield	Options. This field is a vector consisting of up to ten options. Each option consists of subfield OSEL, and refinements that depend on the entry in subfield OSEL. For each option, specify the option selector (OSEL), followed by a space, and the refinements, each separated by a space. The entry is concluded by a \$ and datafill continues with field DFOP.
	OSEL	OFC	Option selector. Enter OFC, followed by a space, and datafill refinement OFC, if a treatment name is required.
		DESTOM	Enter DESTOM in order to associate a destination OM name with a particular destination.

ACCODE (continued)**Field descriptions for conditional datafill (Sheet 2 of 2)**

Field	Subfield or refinement	Entry	Explanation and action
	OFC	alphanumeric (1 to 4 characters)	Office treatment. Enter a treatment name that is contained in the office treatment subtable, TMTCNTL.TREAT.
	DESTOM	Destination OM names that are datafilled in table TERMINFO (16 character vector).	Destination and route based OMs. If the entry in subfield OSEL is DESTOM, datafill this refinement.

Datafill example

The following example shows sample datafill for table ACCODE.

For more detailed information, refer to examples in the description of table ACHEAD.

MAP display example for table ACCODE

XLANAME	FROMD	TOD	
XLADATA			
<hr/>			
FTRXLA	C89	C89	
DMOD (DEL3)	(INSRT CC)	(XLT AC FTRXLA)	\$
FTRXLA	154	154	
DMOD (DEL3)	(INSRT B54B)	(XLT AC FTRXLA)	\$

ACCODE (continued)

MAP display example for table ACCODE

```
XLANAME      FROMD      TOD
  XLADATA

-----
MANUAL 222 222 RTE (DEST 222) (DESTOM BRAZIL_DEST) $
MANUAL 333 333 TRMT (DESTOM UK_DEST) $
MANUAL 444 444 CONT (DESTOM JAPAN_DEST) $
MANUAL 555 555 DMOD (XLT CT MANUAL) (DESTOM PERU_DEST) $
```

MAP display example datafill for the QSIGPR option

```
IDCISD 2800876543 2800876543 FEATINFO PATH_REPLACEMENT
```

MAP display example datafill for the NTAIO option

```
NATL DFLT CONT (CLASS NATL) (NTAIO)
```

ACCODE (continued)**MAP display example datafill for the NTAIT option**

```
NATL DFLT CONT (CLASS NATL) (NTAIT)
```

Table history**MMP15**

Added option PATH_REPLACEMENT to selector FEATINFO for activity 59022854.

Added option NETINFO to selectors CONT and RTE for activity 59023093.

Added option DESTOM to selectors RTE, TRMT, CONT and DMOD for activity 59026196.

Added options NTAIO and NTAIT to selectors CONT and RTE for activity 59022245.

MMP14

Added option DFT to selectors CONT and RTE. (Activity 59016980).

Added options FOC and FDT to selector FTR.

Added option CALLDUR to selector CONT.

Added to selector FEATINFO: CALLCHAR:

- subfield ISPPRFIND with options ISDN_UP_PREF_ALL_THE_WAY, ISDN_UP_PREF_NOT_REQD, ISDN_UP_REQD_ALL_THE_WAY, ISDN_PREF_SPARE
- subfield ACMCGIND with options CI_NO_INDICATION, CI_NO_CHARGE, CI_CHARGE, CI_SPARE

ACCODE (continued)

- subfield ANMCGIND with options CI_NO_INDICATION, CI_NO_CHARGE, CI_CHARGE, CI_SPARE
- subfield ISPRELCS with options USER, PRIVNET, LOCLNET, TRANSNET, RLOCLNET, RPRIVNET, LICBS, INTLNET, SP1, SP2, UNKNOWN, NIL

Added option CCBS for CEPT to selector FTR.

MMP13

Increased table size from 16 384 to 32 768 tuples.

Added options PORTED, NICRF and, suboption INSNNG (to PNRF) to selectors CONT and RTE.

Added CATRTE option within OSEL under CONT, DMOD, and RTE selectors.

Added CALLTYPE option under PRESEL.

MMP12

Added option NOANSTIM to selectors CONT and RTE.

EUR010

Added option CPCRTE to selectors CONT, DMOD, and RTE.

LET010

Added option EXTCIC to selectors CONT, DMOD, and RTE.

APC010

Added option DA to subfield NETSRV_NAME.

Added field TLC_CHARGE to option TLC in the FEATINFO selector.

APC009.1

Added option VMWI to subfield FTR. Added subfields STATUS, VMDN, and PFDIG for option VMWI.

Added station ringer test (SRT) information to FTR section of selector FEAT.

APC009

Added option NETSRV to selectors CONT and RTE.

Added option JES to selector FEATINFO.

ACCODE (continued)

EUR009

Added option BLKOVLP to selector RTE and option PNRF to selectors CONT and RTE.

EUR008

Added CDNRTE, SETCDN, VPNREPL, and VPNXLT options to the DMOD selector.

Added CDNRTE, QFT ON, QFT OFF, SETCDN, and VPNPAN options to the CONT and RTE selectors.

Added HRC selector and PIP option to the RTE selector.

APC008.1

Field CHKCCR was added to all subscriber types (SUBSCTYP) that are part of the SUBSCRN option of selector FEATINFO VALIDATE.

Field EARLYCPG was added to selector FEATINFO.

Option IAA was added to selectors RTE and CONT.

APC008

The following changes were made in APC008:

- option TRUNK was added to field CALLCLASS of option PRESEL for selectors CONT and RTE
- option PRESEL was added to field VALDATOP in selector FEATINFO
- option CLIOVRD was added to selector CONT subfield OSEL

APC007

Added option PRESEL to selectors CONT and RTE.

APC006

Subscriber type PERSONAL was added to option SUBSCRN of FEATINFO VALIDATE.

GL03

The following updates were introduced in GL03:

- added ACF in RTE and CONT selectors
- added CAMA in RTE, CONT, and DNRTE selectors
- added URBAN to selector CLASS

ACCODE (continued)

NA005

The following updates were introduced in NA005:

- Increased universal translations support to 30 digits, affecting the following options, subfields, and selectors:
 - ACF
 - AFTER
 - CONSUME
 - DEL
 - DMOD
 - DNRTE
 - INSRT
 - MAX
 - MIN
 - PF
 - REPL
- Added option SF and refinement SFDIGS to selector DNRTE.
- Added note about potential conflict with refinements CONSUME and PFDIGS.

APC004

Features CALLBACK, CALLCHAR, CLCTDIGS, NTC, and TLC were added to the FTR field of selector FEATINFO.

Options CLDTCCLG, LCASCRN, TCNOTSCR, VERDEST, and V3PTYBIL were added to the VALDATOP subfield of selector FEATINFO.

Subfield CDN of selectors CONT and RTE was modified to incorporate subfields NOA, STOPRTMR, and PFXAMA.

UK002

Option OSS was added to subfield OSEL for selectors CONT and RTE.

BCS36

Option CUSTMOD was added to refinement VALDATOP for XLASEL FEATINFO. Range of field PCCDR changed for selectors CONT and RTE.

BCS35

The following changes were made:

- CGNDM was added to option selector OSEL and refinements.
- Fields PRDFXCLI, INSERTCLI, and CONSUME were added.
- BCSCRN was added to field VALDATOP.
- CPMCALL was added to XLASEL values CONT and RTE.
- Added restrictions on use of VALIDATE.

ACCRLY

Table name

Access Relay Table

Functional description

Table ACCRLY defines the relationship between the trunk test position (TTP) and the location of the relay circuit card (NT5X01AA).

See table TKFXPT for additional information.

Datafill sequence and meaning

You do not need to enter data in other tables before you enter data in table ACCRLY.

Table size

The system automatically allocates memory for a maximum of 16 TTPs. Each TTP has 64 relay groups for a total of 1024 tuples.

Datafill

Datafill for table ACCRLY appears in the following table.

Field descriptions (Sheet 1 of 2)

Field	Subfield or refinement	Entry	Explanation and action
RLYCCT		see subfields	<i>Relay circuit.</i> This field contains subfields TTPNO and NINGRP.
	TTPNO	0 to 15	<i>Trunk test position number.</i> Enter the number assigned to the trunk test position (TTP) that receives access. The access passes through the test access network (TAN) to a specified group of eight trunk module equipment (TME) frames.
	NINGRP	0 to 63	<i>Number in group.</i> Enter the relay group number that assigned the specified group of TME frames.
MODTYPE		TAN	<i>Module type.</i> Enter TAN for the type of module to which a specified relay circuit card (NT5X01AA) is assigned. Any entry outside the range indicated for this field is not allowed.

ACCRLY (end)**Field descriptions (Sheet 2 of 2)**

Field	Subfield or refinement	Entry	Explanation and action
MODNO		0 to 2047	<i>Module number.</i> Enter the module number to which a specified relay circuit card (NT5X01AA) is assigned.
MODCKTNO		0 to 29	<i>Module circuit number.</i> Enter the software card location, on a module, of the relay circuit card (NT5X01AA).

Datafill example

Sample datafill for table ACCRLY appears in the following example.

MAP example for table ACCRLY

TLYCCT	MODTYPE	MODNO	MODCKTNO
0 14	TAN	2000	20

Table history
BCS36

Entries in field MODCKTNO were changed in BCS36.

ACCSDB

Table name

Automatic calling card service data base table

Functional description

Table ACCSDB simulates the line information database (LIDB) for automatic calling card (ACCS) queries during testing efforts. The CI increment tool ACCSVR (automatic credit card service verification) sends queries to the table. The simulated LIDB response is equivalent to the tuple datafilled in table ACCSDB.

Table ACCSDB provides subscriber line information for the automatic calling card (ACCS) feature. This data is datafilled to handle return result, return error, and reject components.

These components are exchanged between the switch and the LIDB for ACCS. The components are formatted according to Common Channel Signaling Number 7 (CCS7) protocol.

The following two figures show the tuples that should be entered in tables CUSTFLDS and CUSTAREA to mask fields that apply to Telecom Canada.

Table CUSTFLDS tuples to mask fields applicable to Telecom Canada

TABFLD	FLDNAME	FSPEC	PRTPOS	REF
ACCSDB 1	ACCSDBKY	ACCSDBKY	1	N
ACCSDB 2	ACCSCOMP	ACCSDBVR\$ ACCSCOMP	20	S
ACCSDB 3	ACCSDBVR	ACCSDBVR	1	R

ACCSDB (continued)**Table CUSTAREA tuples to mask fields applicable to Telecom Canada**

REFAREA	FLDNAME	FSPEC	PRTPOS	DISPLAY	AREAREF
ACCSDB_RESULT_AREA 1	PINNUM	PINNUM	1	Y	N
ACCSDB_RESULT_AREA 2	PINREST	PINREST	7	Y	N
ACCSDB_RESULT_AREA 3	CCANSERV	CCANSERV	17	Y	N
ACCSDB_RESULT_AREA 2	PINSERV	PINSERV	27	Y	N
ACCSDB_RESULT_AREA 5	CCSUBACC	CCSUBACC	37	Y	N
ACCSDB_RESULT_AREA 6	COMPNYID	COMPNYID	47	Y	N
ACCSDB_RESULT_AREA 7	RECSTAT	RECSTAT	50	Y	N
ACCSDB_RESULT_AREA 8	COLLACC	COLLACC	60	Y	N
ACCSDB_RESULT_AREA 9	THIRDNUM	THIRDNUM	1	Y	N
ACCSDB_RESULT_AREA 10	SRVEQUIP	SRVEQUIP	10	Y	N
ACCSDB_RESULT_AREA 11	BILLNUM	BILLNUM	1	Y	N
ACCSDB_RESULT_AREA 12	RAOBC	RAOBC	33	Y	N
ACCSDB_RESULT_AREA 13	PRIMIC	PRIMIC	40	Y	N
ACCSDB_RESULT_AREA 14	ALTIC	ALTIC	50	Y	N
ACCSDB_RESULT_AREA 15	PREFINC	PREFINC	60	Y	N
ACCSDB_RESULT_AREA 16	PRIDIGS	PRIDIGS	1	Y	N
ACCSDB_RESULT_AREA 17	ALTDIGS	ALTDIGS	6	Y	N
ACCSDB_RESULT_AREA 18	INTDIGS	INTDIGS	11	Y	N
ACCSDB_RESULT_AREA 19	BILLBOOL	BILLBOOL	16	Y	N
ACCSDB_RESULT_AREA 20	SPAREIND	SPAREIND	19	Y	N
ACCSDB_RESULT_AREA 21	TELSPARE	TELSPARE	28	Y	N
ACCSDB_RESULT_AREA 22	BCACGCOM	BCACGCOM	41	Y	N
ACCSDB_RESULT_AREA 23	BCACGDUR	BCACGDUR	49	Y	N
ACCSDB_RESULT_AREA 24	BCACGGAP	BCACGGAP	58	Y	N

ACCSVER tool

The CI increment tool ACCSVER simulates checking the signal control point (SCP) database for ACCS numbers through the signaling service 7 (SS7) network without making an actual call. The results of the simulated query are displayed.

ACCSVER can be called up as a CI command in either of two ways:

- ACCSVER
- TESTSS ACCS from the SCCPLOC map level when the ACCS subsystem is posted.

The command input is not changed. The following are the command format and an example:

```
>accsver <intl> <clgnum> <cldnum> <billnum> [<pin>] [<ccitt>]
 [<vall4dig>] [<gtname>]
```

ACCSDB (continued)

```
>accsver n 6093201234 2102201212 5146444433331212
```

The above command format shows brackets for parameters with optional entries. The following are descriptions of the parameters:

- <intl> - International call (overseas)? If yes, enter Y. Otherwise, enter N.
- <clgnum> - Calling number
- <cldnum> - Called number
- <billnum> - Billing number
- <pin> - Personal identification number in the range 0-9999 or no number. If a number is entered, a calling card verification (CCV) query is started. If no number is entered, the system defaults to a billed number screening (BNS) query. For information on BNS queries, refer to functionality Exchange Alternate Billing Service, ABS00001.
- <ccitt> - Is this a CCITT format calling card number? Enter Y if CCITT card, N if not a CCITT card, or make no entry. If no entry, the system assumes that this parameter is not applicable, which occurs, for example, for a collect billed number. If no <pin> parameter is entered, the system assumes this is a collect billed call. Therefore, this<ccitt> parameter is ignored by the system.
- <val14dig> - Is this a valid 14-digit format calling card number? Enter Y if 14-digit format or N if not a 14-digit format.
- <gtname> - Global title name defined in table C7GTTYPE. If no entry is made, the default is used.

The following are example reports.

ACCSDB (continued)

MAP display example of ACCSVER for a non-commercial credit card

```
>accsver n 6093201234 2012201212 2012200000 2000  
  
THE RESPONSE FROM THE DATABASE TOOK 0 MINUTES, 1 SECONDS,  
155 MILLISECONDS  
COMPANY ID IS: 1234  
RECORD STATUS INDICATOR IS STABLE  
RECORD CCSAN IS: 12  
PIN IS UNRESTRICTED  
THE RAO NUMBER IS: 234  
PRIMARY PREFERRED IC INDICATOR IS NOT INDICATED  
ALTERNATE PREFERRED IC INDICATOR IS NOT INDICATED  
INTERNATIONAL PREFERRED IC INDICATOR IS NOT INDICATED  
>
```

MAP display example of ACCSVER for a commercial credit card

```
>accsver n 6093201234 2012201212 5146444433331212 2000  
  
THE RESPONSE FROM THE DATABASE TOOK 0 MINUTES, 1 SECONDS,  
12 MILLISECONDS  
COMPANY ID IS: 1000  
RECORD STATUS INDICATOR IS DEFAULT RECORD  
RECORD CCSAN IS: 1  
PIN IS UNRESTRICTED  
THE RAO NUMBER IS: 721  
PRIMARY PREFERRED IC INDICATOR IS NOT INDICATED  
ALTERNATE PREFERRED IC INDICATOR IS NOT INDICATED  
INTERNATIONAL PREFERRED IC INDICATOR IS NOT INDICATED  
CALL UPDATE REQUIRED: Y  
AUTHORIZATION NUMBER: 12345678901234  
>
```

In the above example, the last two fields (CALL UPDATE REQUIRED and AUTHORIZATION NUMBER) only appear for commercial credit cards.

ACCSDB (continued)

In release TOPS09, the service/equipment field SRVEQIP values are changed to agree with the latest issue of Bellcore document GR-1149: Issue 2, Rev. 2 June '94 as follows:

Service /equipment mapping for call processing

Grouping in call processing	Old service/equipment indicator	New service/equipment indicator
Nil value	NIL	RESERVED
POTS lines	POTS LINE	POTS LINE, BUSINESS/RESIDENTIAL POTS LINE, RESIDENTIAL, RATE 1 POTS LINE, RESIDENTIAL, RATE 2 POTS LINE, BUSINESS, FLAT RATE POTS LINE - BUSINESS, RATE 1 POTS LINE - BUSINESS, RATE 2 POTS LINE, RESIDENTIAL, FLAT RATE LEC PUBLIC ALTERNATE INTERFACE
Coin phones	TELCO PUBLIC COIN CDF TELCO PUBLIC COIN CCF TELCO PUBLIC COIN POSTPAY	LEC PUBLIC, STANDARD INTERFACE, POSTPAY OVERTIME LEC PUBLIC, STANDARD INTERFACE, PREPAY OVERTIME
Semi-public coin	SEMI-PUBLIC COIN CDF SEMI-PUBLIC COIN CCF SEMI-PUBLIC COIN POSTPAY	LEC SEMI-PUBLIC
Public coinless	PUBLIC COINLESS	COINLESS (NON-IPP) COINLESS (IPP)
Card readers	TELCO CARD READER 1 TELCO CARD READER 2	LEC PREPAID TELE COMMUNICATIONS CARD STATION
The remaining indicators are not changed.		

The following are definitions of terms used in the above table:

- Alternate interface - Sets whose functions (that is, rating, coin detection) are controlled locally.
- CDF - Coin, dial-tone first

ACCSDB (continued)

- CCF - Coin, coin first
- Incompatible network - The line is not ACTS compatible.
- IPP - Independent payphone provider
- Postpay overtime - A coin phone where time intervals are paid after they occur.
- Prepay overtime - A coin phone where time intervals are paid before they occur.
- Semi-public - An originating station is a coin phone owned by an LEC for which special agreements have been made with the location provider.
- Standard interface - Sets whose functions (that is, rating, coin detection) are controlled by signalling from the network.

Datafill sequence and implications

There is no requirement to datafill other tables prior to table ACCSDB.

Table size

0 to 64 tuples

Datafill

The following table lists datafill for table ACCSDB.

Field descriptions

Field	Subfield or refinement	Entry	Explanation and action
ACCSDBKY		numeric (vector of up to 18 digits)	ACCS data base key. This field contains the digits that represent the billing number.
ACCSCOMP		REJECT RESULT or ERROR	ACCS (CCS7) component type. This field specifies the CCS7 component type supplied to the local application.
ACCSDBVR		see subfields	ACCS data base variable. The subfields datafilled depend on the value of the ACCSCOMP field.

ACCSDB (continued)

ACCSCOMP = REJECT

If the entry in field ACCSCOMP is REJECT, datafill subfield REJCODE and refinements.

(Sheet 1 of 2)

Field	Subfield or refinement	Entry	Explanation and action
	REJCODE	GENPROB INVKPROB RRPROB REPROB or TPPROB	Reject code. Enter the type of reject code in a reject component. Following are descriptions of the entries: <ul style="list-style-type: none"> • GENPROB - general problem, datafill refinement GENPROB. • INVKPROB - invoke problem, datafill refinement INVKPROB • RRPROB - return result problem, datafill refinement RSLTPROB • REPROB - return error problem, datafill refinement ERRPROB • TPPROB - transaction portion problem, datafill refinement TRNSPROB
	GENPROB	BADCOMP INCTCOMP or UNRCCOMP	General problem. Datafill this field if field REJCODE = GENPROB. Enter the problem for a component. Following are descriptions of the entries: <ul style="list-style-type: none"> • BADCOMP - badly structured component portion • INCTCOMP - incorrect component portion • UNRCCOMP - unrecognized component
	TRNSPROB	BADTP INCTP UNRCPKG or UNRCTID	Transaction problem. Enter the problem in the transaction portion of the component. Following are the values: <ul style="list-style-type: none"> • BADTP - badly structured transaction portion • INCTP - incorrect transaction portion • UNRCPKG - unrecognized package type • UNRCTID- unrecognized transaction id

ACCSDB (continued)

(Sheet 2 of 2)

Field	Subfield or refinement	Entry	Explanation and action
	ERRPROB	INCERR UNCORRE UNEXE UNEXPRE or UNRECERR	<p>Error problem. Enter the problem encountered in the query. Following are the values:</p> <ul style="list-style-type: none"> • INCERR - incorrect parameter in return error • UNCORRE - unrecognized correlation id in return error return error • UNEXE - unexpected error • UNEXPRE - unexpected return error • UNRECERR - unrecognized error
	RSLTPROB	INCTPARR UNRCCIRR or UNEXRR	<p>Return result problem. Enter the problem in a return result component. Following are the values:</p> <ul style="list-style-type: none"> • INCTPARR - incorrect parameter in return result • UNRCCIRR - unrecognized correlation id in return result • UNEXRR - unexpected return result
	INVKPROB	DUPINVID INCTPARA UNRCOPER or UNRCCID	<p>Invoke problem. Enter the problem encountered in an invoke component. Following are the values:</p> <ul style="list-style-type: none"> • DUPINVID - duplicate invoke id • INCTPARA - incorrect parameter • UNRCOPER - unrecognized operation code • UNRCCID - unrecognized correlation id in invoke

ACCSDB (continued)

ACCSCOMP = RESULT

If the entry in field ACCSCOMP is RESULT, datafill the following subfields.

(Sheet 1 of 12)

Field	Subfield or refinement	Entry	Explanation and action
	PINNUM	0000 to 9999	Personal identification number. Enter the personal identification number (PIN) associated with the billing number.
	PINREST	RESTRICT or UNRESTR	<p>PIN restriction indicator. Enter a value to indicate whether the PIN is restricted. Following are the values:</p> <ul style="list-style-type: none"> RESTRICT - restricted. A restricted PIN is valid for station calls to the billing number (collect calls) only. UNRESTR - unrestricted. An unrestricted PIN is valid for station or person calls to all destinations. <p>Note: MAXRESTR and NILRESTR are shown on the MAP display, but are not supported currently.</p>
	CCANSERV	NOPIN NOSRVDEN or SRVDEN	<p>Calling card account number (CCAN) service denial indicator. Enter a value to indicate whether there is a service denial associated with the billing number. Service denial occurs when the threshold is exceeded or because of nonpayment by the subscriber (field PINSERV). Following are the values:</p> <ul style="list-style-type: none"> NOPIN - no PIN assigned NOSRVDEN - no service denial SRVDEN - service denial on CCAN <p>Note: MAXCCAN and NILCCAN are shown on the MAP display, but are not supported currently.</p>

ACCSDB (continued)

(Sheet 2 of 12)

Field	Subfield or refinement	Entry	Explanation and action
	PINSERV	NOSRVDEN THREXCD NOPAYMT or SRVREST	<p>PIN service denial indicator. Enter a value to specify whether there is a service denial associated with the PIN. Following are the values:</p> <ul style="list-style-type: none"> • NOSRVDEN - no service denial on PIN • THREXCD - service denial on PIN due to threshold exceeded • NOPAYMT - service denial on PIN due to nonpayment • SRVREST - service restricted <p>Note: MAXSERV and NILSERV are shown on the MAP display, but are not supported currently.</p>
	CCSUBACC	0 to 99	<p>Calling card subaccount number. Enter the calling card subaccount number (CCSAN). The CCSAN is a two-digit code that appears on the subscriber's bill to distinguish the various users of a CCSAN, each associated with a different PIN.</p>
	COMPNYID	0000 to 9999	<p>Company identification. Enter the company identification (ID). The company ID is a four-digit code that identifies the operating company which is associated with the call.</p>
	RECSTAT	DEFAULT STABLE or TRANSIT	<p>Record status indicator. This field provides status information regarding a particular record. Enter the record status indicator:</p> <ul style="list-style-type: none"> • DEFAULT - default record • STABLE - stable record • TRANSIT - transitional record <p>Note: MAXSTAT and NILRECS are shown on the MAP display, but are not supported currently.</p>

ACCSDB (continued)

(Sheet 3 of 12)

Field	Subfield or refinement	Entry	Explanation and action
	COLLACC	ALLCOLL NOCOLL NOCOLREQ VERCOLL NOCINTTR ALLCITTR VCOLLIVE or VITRRCLV	<p>Collect acceptance indicator. Enter a value to indicate whether the billing number accepts collect calls. The possible responses are as follows:</p> <ul style="list-style-type: none"> • ALLCOLL - accept all collect calls to the billing number without verification. • NOCOLL - no collect calls to the billing number because of service denial • NOCOLREQ - no collect calls to the billing number at the request of the subscriber • VERCOLL - verify all collect calls to the billing number • NOCINTTR - accept all Intra-LATA collect calls to the billing number without verification, but reject all Inter-LATA collect calls • ALLCITTR - accept all Intra-LATA collect calls to the billing number without verification, but verify all Inter-LATA collect calls • VCOLLIVE - verify collect calls to the billing number by the operator if collect services are not automatically denied or accepted. • VITRRCLV - accept all Intra-LATA collect calls to the billing number without verification, but verify all Inter-LATA collect calls by the operator if collect services are not automatically denied or accepted. <p>Note: MAXCOLL and NILCOLL are shown on the MAP display, but are not supported currently.</p>

ACCSDB (continued)

(Sheet 4 of 12)

Field	Subfield or refinement	Entry	Explanation and action
	THIRDNUM	A3RDNUM AITRA3RD NO3RD NO3RDCRQ V3RDNUM VITRA3RD V3RD LIVE VITRA3LV	<p>Third number acceptance indicator. Enter a value to specify if third number billing is allowed to the billed number. The possible responses are as follows:</p> <ul style="list-style-type: none"> • A3RDNUM - accept all third number billed calls to the billed number • AITRA3RD - accept all Intra-LATA third number billed calls to the billed number, but reject all Inter-LATA calls • NO3RD - no third number billed calls to the billed number because of service denial • NO3RDCRQ - no third number billed calls allowed to the billing number at the request of the subscriber • V3RDNUM - verify all third number billed calls to the billed number • VITRA3RD - accept all Intra-LATA third number billed calls to the billed number, but verify all Inter-LATA calls • V3RD LIVE - verify all third number billed calls to the billed number if services are not automatically denied or accepted. • VITRA3LV - accept all Intra-LATA third number billed calls to the billed number, but verify all Inter-LATA calls if services are not automatically denied or accepted. <p>Note: MAX3RD and NIL3RD are shown on the MAP display, but are not supported currently.</p>

ACCSDB (continued)

(Sheet 5 of 12)

Field	Subfield or refinement	Entry	Explanation and action
	SRVEQUIP	AQNOTAX AQTAX BUS1 BUS2 BUSFLAT BUSML BUSSL CELL CELLR1 CELLR2 CENTREX DORM FGA HOSPITAL ICALT ICSTD INCPIF IPALT IPSTD LECALT LECPOST LECPRE LECSEMI MOBILE NCNIPP NCNNOIPP OTHER1 OTHER2 OTHER3 OTHER4 PAGER PBX PCS PRETCS POST POTSLINE PRISON PRSNIPP	<p>Service machine. Enter the type of equipment being serviced. There are six general categories of equipment serviced: POTS lines, coin phones, semi-public coin, public coinless, card reader, and other non-POTS lines. The values are as follows:</p> <ul style="list-style-type: none"> • AQNOTAX - Autoquote without tax • AQTAX - Autoquote with tax • BUS1 - POTS line, business, message rate 1 • BUS2 - POTS line, business, message rate 2 • BUSFLAT - POTS line, business, flat rate • BUSML - POTS line, business, multiple line • BUSSL - POTS line, business, single line • CELL - Cellular • CELLR1 - Cellular rate 1 • CELLR2 - Cellular rate 2 • CENTREX - Centrex line • DORM - Dormitory line • FGA - Feature group A • HOSPITAL - Hospital • ICALT - Interlata carrier (IC) public, alternate interface • ICSTD - IC public, standard interface • INCPIF - Public, incompatible network interface • IPALT - Independent payphone provider (IPP), alternate interface • IPSTD - IPP, standard interface

ACCSDB (continued)

(Sheet 6 of 12)

Field	Subfield or refinement	Entry	Explanation and action
	SRVEQUIP (continued)	RES1 RES2 RESERVED RESFLAT SPLPOST SPLPRE WATS VQNOTAX VQTAX	<p>Service machine (continued)</p> <ul style="list-style-type: none"> • LECALT - Local exchange carrier (LEC) public, alternate interface • LECPOST - LEC public, standard interface, postpay overtime • LECPRE - LEC public, standard interface, prepay overtime • LECSEMI - LEC semi-public • MOBILE - Mobile • NCNIPP - Coinless, IPP • NCNNOIPP - Coinless, non-IPP • OTHER1-4 - Other 1 to Other 4 • PAGER - Pager • PBX - PBX line • PCS - Personal communication service • PRETCS - LEC prepaid telecommunications card station • POST - Public postpay • POTSLINE - Plain ordinary telephone service (POTS) line, business or residential • PRISON - Prison IPP • PRSNIPP - Prison non-IPP • RES1 - POTS line, residential, message rate 1 • RES2 - POTS line, residential, message rate 2 • RESERVED - Reserved • RESFLAT - POTS line, residential, flat rate

ACCSDB (continued)

(Sheet 7 of 12)

Field	Subfield or refinement	Entry	Explanation and action
	SRVEQUIP (continued)		Service machine (continued) <ul style="list-style-type: none"> • SPLPOST - LEC public, special billing, postpay overtime • SPLPRE - LEC public, special billing, prepay overtime • WATS -WATS line • VQNOTAX - Voice quote without tax • VQTAX - Voice quote with tax <p>Note: MAXEQUIP is shown on the MAP display, but is not currently supported.</p>
	BILLNUM	numeric, up to 24 digits	Billing number. Enter the billing number of the calls. Any entry outside the range indicated for this field is invalid.
	RAOBC	numeric (vector of up to 3 digits)	Revenue accounting office digits. Enter the digits that are recorded on automatic message accounting (AMA) for each calling card validation (CCV) and billed number screening (BNS) queries that are sent.
	PRIMIC	DENIED INDICATE or NOTIND	Primary Inter-LATA carrier. Enter the state of the primary preferred Inter-LATA carrier. Following are the values: <ul style="list-style-type: none"> • DENIED - no carrier because of service denial • INDICATE - carrier is indicated • NOTIND - carrier not indicated <p>Note: MAXIND and NILIND are shown on the MAP display, but are not supported currently.</p>

ACCSDB (continued)

(Sheet 8 of 12)

Field	Subfield or refinement	Entry	Explanation and action
	ALTIC	DENIED INDICATE or NOTIND	<p>Alternate Inter-LATA carrier. Enter the state of the preferred alternate Inter-LATA carrier. Following are the values:</p> <ul style="list-style-type: none"> • DENIED - no carrier because of service denial • INDICATE - carrier is indicated • NOTIND - carrier not indicated <p>Note: MAXIND and NILIND are shown on the MAP display, but are not supported currently.</p>
	PREFINC	DENIED INDICATE or NOTIND	<p>Preferred international carrier. Enter the state of the preferred international carrier. Following are the values:</p> <ul style="list-style-type: none"> • DENIED - no carrier because of service denial • INDICATE - carrier is indicated • NOTIND - carrier not indicated <p>Note: MAXIND and NILIND are shown on the MAP display, but are not supported currently.</p>
	PRIDIGS	numeric (vector of up to 4 digits)	Primary Inter-LATA carrier digits. Enter the primary Inter-LATA carrier digits identifying the primary IC.
	ALTDIGS	numeric (vector of up to 4 digits)	Alternate Inter-LATA carrier digits. Enter the alternate Inter-LATA carrier digits identifying the alternate IC.
	INTDIGS	numeric (vector of up to 4 digits)	International carrier digits. Enter the international Inter-LATA carrier digits identifying the INC.
	BILLBOOL	Y or N	Billing number. Enter if there is a referral billing number.
	SPAREIND	NOSPARE SPARE1 or SPARE2	Spare indicator. Enter the spare indicator.

ACCSDB (continued)

(Sheet 9 of 12)

Field	Subfield or refinement	Entry	Explanation and action
	TELSPARE	TELSPAR1 TELSPAR2 TELSPAR3 TELSPAR4 or NOTELSPARE	Operating company spare. Enter the operating company spare indicators.
	BCACGCOM	INVCOMP	Bellcore automatic call gapping component. Enter the Bellcore ACG component. <ul style="list-style-type: none"> • INVCOMP - invalid component <p>Note: NILCOMP is shown on the MAP display, but is not supported currently.</p>
	BCACGDUR	1SEC, 2SEC, 4SEC, 8SEC, 16SEC, 32SEC, 64SEC, 128SEC, 256SEC, 512SEC, 1024SEC, or 2048SEC	Bellcore automatic call gapping duration. Enter the ACG duration. <p>Note: MAX_DUR and NILDUR are shown on the MAP display, but are not supported currently.</p>
	BCACGGAP	0SEC, 3SEC, 4SEC, 6SEC, 8SEC, 11SEC, 16SEC, 22SEC, 30SEC, 42SEC, 58SEC, 81SEC, 112SEC, 156SEC, 217SEC, or 300SEC	Bellcore automatic call gapping gap. Enter the ACG gap.

ACCSDB (continued)

(Sheet 10 of 12)

Field	Subfield or refinement	Entry	Explanation and action
	INTRCEPT	NOINT, VCA, NOTSERV, DISCON, NONPUB, CUSTDISC, TEMPDISC, CHANGED, INTCP, CHANGING, NOTCON, TMPCON, DISCALL, or TMPNOSRV	<p data-bbox="821 464 1406 554">Intercept. This field indicates whether a number is working, and if not, what is the applicable condition. Following are the values:</p> <ul data-bbox="821 575 1406 1415" style="list-style-type: none"> <li data-bbox="821 575 1154 604">• NOINT - not intercepted <li data-bbox="821 625 1127 655">• VCA - vacant number <li data-bbox="821 676 1393 705">• NOTSERV - not in service for incoming calls <li data-bbox="821 726 1338 756">• DISCON - disconnected without referral <li data-bbox="821 777 1406 806">• NONPUB - changed to nonpublished number <li data-bbox="821 827 1386 917">• CUSTDISC - temporarily disconnected at customer's request without referral to a new number <li data-bbox="821 938 1386 1029">• TEMPDISC - temporarily disconnected with referral to a new number <li data-bbox="821 1050 1386 1140">• CHANGED - changed with referral to a new number <li data-bbox="821 1161 1386 1190">• INTCP - special intercept treatment required <li data-bbox="821 1211 1406 1302">• CHANGING - being changed, may not yet be connected <li data-bbox="821 1323 1317 1352">• NOTCON - may not yet be connected <li data-bbox="821 1373 1273 1402">• TMPCON - temporarily connected <li data-bbox="821 1423 1325 1453">• DISCALL - disconnected, call taken by <li data-bbox="821 1474 1349 1564">• TMPNOSRV - temporarily removed from service, calls taken by <p data-bbox="821 1453 1360 1514">Note: MAXINT and NILINT are shown on the MAP display, but are not supported currently.</p>

ACCSDB (continued)

(Sheet 11 of 12)

Field	Subfield or refinement	Entry	Explanation and action
	BNSTRMT	NOTRMT, TONE, TONEANN, OPRSTAT, OPRCUST, HANDICAP1, or HANDICAP2,	<p>Billed number screening treatment. This field indicates the type of line treatment and prompt to be given for post seizure dialing. Following are the values:</p> <ul style="list-style-type: none"> • NOTRMT - no treatment • TONE - automated treatment: provide alerting tone only • TONEANN - automated treatment: provide alerting tone and prompt • OPRSTAT - operator treatment: operator handling (station limitations) • OPRCUST - special treatment: operator handling at customer request • HANDICAP1 and HANDICAP2 - special treatment: handicapped 1 and 2 <p>Note: MAXTRMT is shown on the MAP display, but is not supported currently.</p>
	UPDDATA	Y or N	<p>Call update data. This field indicates whether call update data is present. The values are Y (present) and N (not present). This field should be datafilled with N for non-commercial credit cards since the call update data is never present in a real query. If the entry is Y, datafill refinements UPDREQ and AUTHDIGS.</p>
	UPDREQ	Y or N	<p>Call update required. Datafill this field if subfield UPDDATA = Y. This field indicates whether a call update query is required for the call. The values are Y (required) and N (not required).</p>
	AUTHDIGS	up to 15 digits	<p>Authorization digits. Datafill this field if subfield UPDDATA = Y. Enter the authorization number.</p>
	AOSPID	see subfield AOIND	<p>Account owner service provider identifier. This field consists of subfield AOIND and refinement.</p>

ACCSDB (continued)

(Sheet 12 of 12)

Field	Subfield or refinement	Entry	Explanation and action
	AOIND	Y or N	Account owner SPID indicator. Is an AO SPID assigned to this billing number? Enter Y (yes) or N (no). If Y, datafill refinement SPID. The default is N.
	SPID	4 alphanumeric characters	Service provider identifier. If field AOIND = Y, datafill exactly 4 alphanumeric characters for the AO SPID.
	BSPSPID	see subfield BSPIND	Billing service provider identifier. This field consists of subfield BSPIND and refinement.
	BSPIND	Y or N	Billing SPID indicator. Is a BSP SPID assigned to this billing number? Enter Y (yes) or N (no). If Y, datafill refinement SPID. The default is N.
	SPID	4 alphanumeric characters	Service provider identifier. If field BSPIND = Y, datafill exactly 4 alphanumeric characters for the BSP SPID.

ACCSCOMP = ERROR

If the entry for field ACCSCOMP is ERROR, datafill subfield ERRCODE.

Field	Subfield or refinement	Entry	Explanation and action
	ERRCODE	UNEXDATA, UNAVNETR, MISSREC, DATAUNAV, SCRNRESP, MISROUTE, MISSGRP, VACANTGR, or NONPARGR	<p>Error code. Enter the type of error code in a return error component. Following are the values:</p> <ul style="list-style-type: none"> • UNEXDATA - unexpected data value • UNAVNETR - unavailable network resource • MISSREC - missing customer record • DATAUNAV - data unavailable • SCRNRESP - screen response error • MSROUTE - missing route • MISSGRP - missing group • VACANTGR - vacant group • NONPARGR - non-parameter group

ACCSDB (end)

Datafill example

The following example shows sample datafill for table ACCSDB.

MAP display example for table ACCSDB

ACCSDBKY	ACCSCOMP	ACCSDBVR
2222121123	RESULT	
2212 UNRESTR	NILCCAN NILSERV 3 3496	DEFAULT VERCOLL A3RDNUM
POTSLINE 2122221212	353 NILIND NILIND	NILIND 5555 5334 5665
N NOSPARE	NOTELSPARE NILCOMP 1SEC	0SEC NOINT TONEANN Y 1234 Y
ABCD		

Table history

TOPS11

The calling card subaccount number (CCSAN) is changed by feature 50096155. This feature changes the range of the CCSAN from {0 to 20} to {0 to 99}.

TOPS09

For field ACCSCOMP = RESULT, subfields AOSPID and BSPSPID are added and the values for field SRVEQUIP are changed by feature AF7133 in functionality Billing Changes, UNBN0001.

TOPS08.1

For field ACCSCOMP = RESULT, subfield UPDDATA and refinements (UPDREQ and AUTHDIGS) added by feature AF6958 in functionality TOPS Commercial Credit Card, ABS00008.

ACCSERR

Table name

Automatic Calling Card Service Errors Table

Functional description

This table allows datafilling of the desired reaction when something other than a normal/successful message (an error message or no message at all) message is received in response to an Automatic Calling Card Service (ACCS) line information database (LIDB) query. Table ACCSERR is used by tables BNSPARMS and CCVPARMS to select the appropriate function.

Note: The actions specified in table ACCSERR take precedence over any other actions specified by existing datafill and office parameters.

Two default tuples are added to this table at IPL time. Tuple 0 is the default tuple for CCV (Calling Card Validation) queries. Tuple 1 is the default tuple for BNS (Billed Number Screening) queries.

The key field is IDX. The remaining fields in table ACCSERR represent abnormal LIDB queries and have identical datafill entries. Enter the desired DMS reaction for each abnormal LIDB query. Entries are A (accept), B (block), O (attach operator), or V (verify).

Following are the reaction definitions:

- A (accept) - The call is allowed, treated as if the LIDB response accepts the billing, even though the validation failed. ACC is displayed as information describing the Special Number, to indicate the billing is ACCEPTED.
- B (block) - The call is denied with this billing. The action taken as a result of this BLOCK is usually a reprompt. The actual action taken depends upon the environment from which the query was launched. If the environment is AABS, datafill in the VSN and the particular implementation of the VSN determine the action taken. Possible actions are:
 - Reprompt for the calling card account number (CCAN).
 - Disconnect treatment
 - Enable a treatment indicating to the caller that the call is routed to an operator, followed by transfer to an operator.
 - Reprompt the caller for a new billing option.
- V (verify) - Verification of acceptance from the billed party is required. The verification may be by a live operator or by AABS. This value should not be used for CCV queries, as verify makes no sense for CCV queries. It

ACCSERR (continued)

is intended for use with BNS queries. If used for a BNS query, it is interpreted as ATTACH OPERATOR.

- O (attach operator) - Route the call to a live operator as a result of a CCV or BNS query failing. Upon presentation to the operator, QRYFL is displayed in the information area of the Special Number field for TOPS IV or in the Application Message Area II field for TOPS MP. This indicates to the operator that the call was presented as a result of processing table ACCSERR after "database validation failed" (the database returned something other than an indicator that the billed number was valid). The operator may then decide and take the appropriate action once the call is presented (this includes floating the call).

Datafill sequence and implications

This table must be datafilled prior to tables CCVPARMS (Calling Card Validation Parameters) and BNSPARMS (Billed Number Screening Parameters), because they contain indexes into this table.

Datafill

The following table lists the datafill for table ACCSERR.

Field descriptions (Sheet 1 of 5)

Field	Subfield or refinement	Entry	Explanation and action
IDX		0 to 254	Index. Indexed by tables CCVPARMS (field PUBCCV or PRIVCCV) and BNSPARMS (field PUBCOLL, PRIVCOLL, PUB3RD, or PRIV3RD). The default values are 0 and 1.
NOXLSPAD		A (ACC), V (VFY), O (Attach Operator), B (BLK)	No Translation for This Specific Address. This error code indicates an error in Global Title Translations generated at the SCCP level. The translating entity for a message destined for an LIDB may have no entry in its translating table for the global title. An arbitrarily chosen calling card number with an unused NPA (Numbering Plan Area) or RAO (Revenue Accounting Office) code may cause this error. The default value is O.

ACCSERR (continued)**Field descriptions (Sheet 2 of 5)**

Field	Subfield or refinement	Entry	Explanation and action
UNEQUUSER		A, V, O, B	<p>Unequipped User. This SCCP error code indicates corrupt addressing information in the Called Party Address parameter of the query message.</p> <p>The default value is O.</p>
NETFAIL		A, V, O, B	<p>Network Failure. This SCCP error code indicates failure of the Common Channel Signaling 7 (CCS7) network.</p> <p>The default value is O.</p>
NETCONG		A, V, O, B	<p>Network Congestion. This SCCP error code indicates congestion of the CCS7 network.</p> <p>The default value is O.</p>
SUBSFALL		A, V, O, B	<p>Subsystem Failure. This SCCP error code indicates failure of the line information database (LIDB) node.</p> <p>The default value is O.</p>
SUBSCONG		A, V, O, B	<p>Subsystem Congestion. This SCCP error code indicates congestion of the LIDB node.</p> <p>The default value is O.</p>
NOXLADDR		A, V, O, B	<p>No Translation for an Address of Such Nature. This error code indicates a serious SCCP-layer operational problem, either in the OSS (Operator Services System) or in the STP (Signaling Transfer Point).</p> <p>The default value is O.</p>
PROTPROB		A, V, O, B	<p>Protocol Problems. This Transaction Capabilities Application Part (TCAP) error code indicates that the query message sent by the OSS is not formatted according to protocol. PROTPROB also indicates that serious problems have been encountered with the OSS's TCAP APDU or Invoke OPDU. This is an indication of a serious operational problem in either the OSS or the LIDB.</p> <p>The default value is B.</p>

ACCSERR (continued)

Field descriptions (Sheet 3 of 5)

Field	Subfield or refinement	Entry	Explanation and action
UNEXDATA		A, V, O, B	<p>Unexpected Data Value. This field represents the DMS reaction to a personal identification number (PIN) mismatch or incorrect data element contents. If returned with a PIN (message TYPE1, No PIN Match), this indicates a PIN mismatch. If returned in the Application Error Message, it indicates incorrect data element contents.</p> <p>The default value is B.</p>
UNAVNETR		A, V, O, B	<p>Unavailable Network Resource. This TCAP error code indicates that the LIBD is not equipped to process a particular query request. For example, the LIDB processes CCV queries, but not BNS queries.</p> <p>The default value is B.</p>
MISSREC		A, V, O, B	<p>Missing Record. The Line Number or Special Billing Number record required to process an Invoke OPDU may be missing in the LIDB (e.g., the NPA-NXX has working line numbers, but not this particular line number). This TCAP error occurs in LIDB implementations that are not a positive database for an active NPA-NXX or RAO-0/1XX group.</p> <p>The default value is B.</p>
SCRNRESP		A, V, O, B	<p>Screened Response. This TCAP error indicates that the operator services system (OSS) is not authorized to access the requested data. SCRNRESP is not used for LIDB/BVD.</p> <p>The default value is B.</p>

ACCSERR (continued)

Field descriptions (Sheet 4 of 5)

Field	Subfield or refinement	Entry	Explanation and action
MISROUTE		A, V, O, B	<p>Misroute. The BVD receives a query request for information outside its domain, as determined by a check of the table of card issuers that it supports. Some LIDB implementations may maintain a table of the NPAs and RAOs for which it has information. If the LIDB receives an Invoke OPDU targeted to a line number or special billing number outside its domain, as determined by a check of this table, TCAP error code MISROUTE will be generated. MISROUTE indicates a serious operational problem, either in the STP providing the Global Title Translations service, or in the LIDB.</p> <p>The default value is B.</p>
MISSGRP		A, V, O, B	<p>Missing Group. The LIDB receives a query request for a group outside its domain, as determined by a check of the table of card issuers that it supports. Whether this TCAP error is classified as MISSGRP or MISROUTE depends upon the implementation of the LIDB. The TCAP error code MISSGR indicates a serious operational problem in the LIDB or the CCS network.</p> <p>The default value is B.</p>
VACANTGR		A, V, O, B	<p>Vacant Group. The NPA-NXX or RAO-0/1XX portion of a calling, called, or purported billed number has no working lines or special billing numbers, respectively, associated with it.</p> <p>The default value is B.</p>
NONPARGR		A, V, O, B	<p>Non-participating Group. The calling, called, or purported billed number may belong to the domain of a Non-Bell Exchange Carrier that does not participate in LIDB-based services. This TCAP error is not generated by the BVD.</p> <p>The default value is B.</p>

ACCSERR (continued)**Field descriptions (Sheet 5 of 5)**

Field	Subfield or refinement	Entry	Explanation and action
TIMEOUT		A, V, O, B	<p>Timeout. The DMS switch does not receive a response before timer T1 expires, either because of failure or an excessive delay in the signaling network (an SCCP error), or because of a failure in the target LIDB (a TCAP error). The OSS should assume that no LIDB is available.</p> <p>The default value is O.</p>
MISCERR		A, V, O, B	<p>Miscellaneous Error. A miscellaneous error is generated when:</p> <ul style="list-style-type: none"> • a query is blocked due to Automatic Call Gapping (ACG), • an invalid type of LIDB response message (i.e., one that is neither SS7 nor SCCP) is received, or • an LIDB response message containing invalid data is received. <p>The default value is O.</p>

Datafill example

The following example shows sample datafill for table ACCSERR.

ACCSERR (continued)**MAP display example for table ACCSERR**

IDX	NOXLSPAD	UNEQUUSER	NETFAIL	NETCONG	SUBSFALL	SUBSCONG
NOXLADDR	PROTPROB	UNEXDATA	UNAVNETR	MISSREC	SCRNRESP	MISROUTE
MISSGR	VACANTGR	NONPARGR	TIMEOUT	MISCERR		
0	A	A	A	A	A	A
A	A	A	A	A	A	A
A	A	A	A	A		
1	B	B	B	B	B	B
B	B	B	V	A	B	A
A	V	V	B	B		
2	A	A	A	A	A	A
A	A	A	A	A	A	A
A	A	A	A	A		
3	A	A	A	A	A	A
A	A	A	A	A	A	A
A	A	A	A	A		

Table history**BCS35**

Changes to support global ACCS were added.

BCS34

Table ACCSERR was introduced. And modified by feature AN0342 in NTX825AB, TOPS EABS.

Supplementary information

This section provides information on dump and restore procedures for table ACCSERR.

Dump and restore procedures

When table ACCSERR is introduced it contains two default tuples from initial program load (IPL). Tuple 0 is the default tuple for calling card validation (CCV) queries. Tuple 1 is the default tuple for Traffic Operator Position System (TOPS) billed number screening (BNS) queries.

Tuple 1 is not used by the global version of ACCS. For dump and restore from BCS34 to BCS35, office parameter ACCS_CCV_QUERY_BLK in table OFCVAR is replaced by tuple 0 in this table. If ACCS_CCV_QUERY_BLK is set to Y (yes), all fields are set to B. Otherwise, all fields are set to A.

ACCSERR (end)

Other tuples can be datafilled as a result of the dump and restore of table INTCCFMT. See tables CCVPARMS and CCVINFO for additional information. Subsequent dump and restore actions copy existing table values.

ACDADMIN

Table name

Automatic Call Distribution Administration Groups Table

Functional description

Table ACDADMIN contains the valid Automatic Call Distribution (ACD) senior supervisor login identification (ID) and ACD administration group (ADMINGRP) associated with that login ID. An ACD administration group is the collection of ACD groups that are accessible to the senior supervisor for load management purposes. An ACD administration group can appear only in table ACDADMIN, and can be assigned to only one senior supervisor.

The ACDADMIN option is also entered in table ACDGRP. When this option is entered, field ADMINGRP is prompted. Valid input for this field is an ACD administration group number in the range of 1 to 255. ACD groups from different customer groups can be assigned to the same ACD administration group.

Senior supervisors are issued login IDs and passwords. Only supervisors having login IDs appearing in table ACDADMIN can display and manipulate ACD groups that are associated with that login ID.

Using the command interpreter (CI) command PERMIT, a total of 256 user names can be added to the list of valid user names, including the name assigned to switchroom personnel. Up to 255 senior supervisor login IDs can be assigned in table ACDADMIN, depending on the number of switchroom personnel already listed as valid users.

For more information about ACD, see table ACDGRP.

Datafill sequence and implications

Table USERINF must be datafilled before table ACDADMIN.

This table can be datafilled only after the legal users are assigned by using the PERMIT command.

Table size

0 to 255 tuples

ACDADMIN (end)

Datafill

The following table lists datafill for table ACDADMIN.

Field descriptions

Field	Subfield or refinement	Entry	Explanation and action
ADMINSUP		alphanumeric (up to 16 characters)	<i>Administration group supervisor</i> Enter the login ID of the senior supervisor. This must be a legal user name assigned using CI command PERMIT.
ADMINGRP		1 to 255	<i>Administration group</i> Enter the ACD administration group number associated with the user name datafilled in field ADMINSUP.

Datafill example

The following example shows sample datafill for table ACDADMIN.

In the example, ACD administration group 124 is assigned to senior supervisor SUPR4.

MAP display example for table ACDADMIN

ADMINSUP	ADMINGRP
SUPR4	124

ACDDNDR**Table name**

Automatic Call Distribution Directory Number Route table

Functional description

Table ACDDNDR is a logical partition of table DNROUTE, containing only ACD group directory numbers. This subset of DNROUTE is read only and is used during the dump and restore process. It is maintained internally by the switch whenever DNROUTE is updated.

Datafill sequence and meaning

There is no requirement to enter datafill into other tables before table ACDDNDR.

Table size

The system dynamically allocates table store.

Datafill

The table that follows lists datafill for table ACDDNDR.

Field descriptions (Sheet 1 of 4)

Field	Subfield	Entry	Explanation and action
ACDDNKEY		see subfields	<i>Automatic Call Distribution Directory Number Key</i> This field is key to the table and consists of subfields ACDDNDR_KEY and DNSYSLOG.
ACDDNDR_KEY		see subfields	This field is key to the field ACDDNKEY and consists of subfields ACD_GROUP and ACD_DN.
ACD_GROUP		alphanumeric (1 to 16 characters)	<i>Automatic call distribution group</i> This field indicates the name in field ACDNAME of table ACDGRP for this ACD DN.
ACD_DN	SVGNPA		<i>Serving number plan area</i> This field lists the SNPA of the DN that the user must dial to reach the DN specified in the key.

ACDDNDR (continued)

Field descriptions (Sheet 2 of 4)

Field	Subfield	Entry	Explanation and action
	NNX	3-digit integer	<i>Office code</i> This field lists the three-digit office code of the DN that the user must dial to reach the DN specified in the key.
	DEFDDIGS	4-digit integer	<i>DEFG digits</i> This field lists the DEFG digits of the DN that the user must dial to reach the DN specified in the key.
DNSYSLOG		see subfields	This field is key to field ACDDNKEY and consists of subfields DNSYSKEY and DNRESULT.
DNSYSKEY	AREACODE	0 to 9999999 (1 to 7 digits)	<i>Area code</i> The area code identifies a major geographical area served by the switch. If office parameter ACTIVE_DN_SYSTEM in table OFCENG is set to North American, the area code must be three digits long.
	OFCCODE	0 to 9999999 (0 to 7 digits)	<i>Office code digit register</i> The office code is a subregion of the area code. If office parameter ACTIVE_DN_SYSTEM in table OFCENG is set to North American, the area code must be three digits long. The office code must be specified in table TOFCNAME.

ACDDNDR (continued)

Field descriptions (Sheet 3 of 4)

Field	Subfield	Entry	Explanation and action
	STNCODE	0 to 99999999 (1 to 8 digits)	<p><i>Station code</i></p> <p>The station code identifies a unique station within the terminating office (TOFC). If office parameter ACTIVE_DN_SYSTEM in table OFCENG is set to North American, the area code must be one or four digits in length. If one digit is entered, it is treated as a D-digit, where the D-digit represents the fourth digit in the format ABC-DEFG.</p> <p>A D-digit is then given the appropriate DN result. For example, if area code 613 and office code 226 are entered, and if 5 is entered as the station code, any calls to a number beginning with 6132265 are automatically routed to the specified treatment. If 5 is the D-digit, and DNROUTE is datafilled as 613 226 5 D OPRT, any numbers for 6132265 are routed to the operator treatment as set in table TMTCNTL.</p>
DNRESULT		see subfields	<p><i>Directory number results</i></p> <p>This field consists of subfields DN_SEL, FEATURE, ACDGRP, and DNAREA.</p>
	DN_SEL	FEAT	<p><i>Directory number selector</i></p> <p>This field lists the directory number (DN) selector FEAT.</p>
	FEATURE	ACD	<p><i>Automatic Call Distribution</i></p> <p>This field lists the feature ACD.</p>
	ACDGRP	alphanumeric (1 to 16 characters)	<p><i>Automatic call distribution group</i></p> <p>This field indicates the name in field ACDNAME of table ACDGRP for this ACD DN.</p>

ACDDNDR (end)

Field descriptions (Sheet 4 of 4)

Field	Subfield	Entry	Explanation and action
	DNAREA	see subfield	<i>Directory number area</i> This field consists of subfield DNTYPE.
	DNTYPE	PRIM or SUPP	<i>Directory number type</i> This field lists PRIM if the DN is the primary UCD DN for this UCD group. Enter SUPP if the DN is one of the supplementary DNs for this UCD group

Datafill example

The figure that follows shows sample datafill for table ACDDNDR.

MAP display example for table ACDDNDR

ACDDNKEY								DNSYSLOG			

PIZZAPIZZA	613	722	1111								
		613	722	1111	FEAT	ACD	PIZZAPIZZA	PRIM	2	2	
FTD_FLORIST	613	722	2222								
		613	722	2222	FEAT	ACD	FTD_FLORIST	PRIM	2	2	

Table history

NA012

Development activity 59007050 introduces changes to field ACD_GROUP of table ACDDNDR. This field now accepts an alphanumeric string instead of an integer string

BCS35

Table ACDDNDR was created in BCS35 to reduce ONP time.

ACDENLOG

Table name

Automatic Call Distribution Login Enhancement Table

Functional description

Table ACDENLOG allows multiple customer groups to use the full range of login identifications (ID) for their Automatic Call Distribution (ACD) agents, rather than only using the range that is allotted to the customer group.

The ACD Agent Login Enhancement feature (AD0620) ensures that only ACD personnel assigned to a specific login ID can use that ID.

Table ACDENLOG has the same format as table ACDLOGIN. The same security checks, or screening restrictions, are assigned in both tables. Screening is accomplished through customer group restrictions and password association, based on the login ID of the ACD agent. Screening restrictions in both tables are optional.

Feature Make Set Busy (MSB) must be deactivated before an agent attempts to login. If the agent login ID is found in table ACDENLOG and if field CUSTSEL is set to Y (yes), the customer group associated with that particular agent login ID is checked against the customer group of the INCALLS key of the agent's set. If there is no match, a reorder tone is given. If field CUSTSEL is set to N (no), but the agent login ID appears in the table, the login procedure continues with no further security checks.

If field CUSTSEL is set to Y and the customer groups match, table ACDENLOG is rechecked to determine if a password is associated with this agent login ID. If field PSWDSEL is set to Y, the agent receives a special dial tone. The agent must then enter a four-digit number from 0001 to 9999. The password is not displayed.

The agent receives the reorder tone if an incorrect password is entered, or if the agent login ID has already been used by another agent. If field PSWDSEL is set to N, the special dial tone is not received by the agent and the normal login procedure continues.

If all the checks are passed and if ACDNR in table KSETLINE has been datafilled for the agent, the ACD INCALLS lamp and the MSB lamp are extinguished. The ACDNR lamp is then lit and the agent is placed in the ACD Not Ready queue. The agent must deactivate ACD Not Ready in order to receive ACD calls.

ACDENLOG (continued)

The password of a specific agent login ID can be displayed using the parameter LOGINID of the command interpreter (CI) command ACDSHOW. The passwords datafilled in table ACDENLOG are not necessarily unique. The same password can be used by several agents or assigned to all agents in the same group or subgroup.

Table ACDENLOG is indexed by a two-part key, field PARTNO and field LOGINID. These fields, when datafilled, together access a tuple in table ACDENLOG.

For related information on ACD, refer to table ACDLOGIN and table CUSTACD.

Datafill sequence and implications

The following tables must be datafilled before table ACDENLOG:

- ACDGRP
- CUSTHEAD
- CUSTACD (to access table ACDENLOG)
- CUSTENG (for customer access during login process)

To access table ACDENLOG, option ENLOG must be added to the customer group in table CUSTACD, with field INUSE set to Y. The agent that is logging in must belong to that customer group.

If table ACDENLOG must be accessed for a customer group during the login process, table CUSTENG and table CUSTACD must be datafilled before datafilling table ACDENLOG. This datafill sequence is not enforced if a telephone operating company needs to set up table ACDENLOG with certain partitions and login IDs for future assignments of option ENLOG to customer groups in table CUSTACD.

Table size

0 to 30 000 tuples

ACDENLOG (continued)**Datafill**

The following table lists datafill for table ACDENLOG.

Field descriptions

Field	Subfield	Entry	Explanation and action
PARTNO		0 to 1024	<i>Automatic call distribution partition number</i> Enter the partition number for a customer group. Partition numbers are found in table CUSTACD in option ENLOG, field PARTNO.
LOGINID		00001 to 30000	<i>ACD login identification</i> Enter the Automatic Call Distribution (ACD) agent login identification. The login identification (ID) is unique for each partition. Any entry outside the range indicated for this field is invalid.
ACTIVATE		Y or N	<i>Activate</i> Enter Y (yes) to activate the login ID for a partition. An agent using this login ID, and belonging to the customer group assigned to this partition, can log in. Enter N (no) to deactivate the login ID. Note: Field ACTIVATE controls the NEW LOADMGMT command CHANGE ACTIVATE.
CUSTGRP		see subfield	<i>Customer group</i> This field consists of subfield CUSTSEL.
	CUSTSEL	Y or N	<i>Customer group selector</i> Enter Y if the customer group associated with the agent login ID is checked (customer group check) when the agent logs in and datafill refinement CUSTGRP. Otherwise, enter N and go to field PSWD. Note: If field OPTION is set to MISGROUP, a customer group check must be carried information system (MIS) message confusion.

ACDENLOG (continued)**Field descriptions**

Field	Subfield	Entry	Explanation and action
PSWD	CUSTGRP	alphanumeric (1 to 16 characters)	<i>Customer group</i> If the entry in subfield CUSTSEL is Y, datafill this refinement. Enter the name of the customer group that is associated with this login ID.
		see subfield	<i>Password</i> This field consists of subfield PSWDSEL.
	PSWDSEL	Y or N	<i>Password selector</i> Enter Y if a password is required during the login procedure and datafill refinement PSWD. Otherwise, enter N and go to field OPTION. Any entry outside the range indicated for this field is invalid.
OPTIONS	PSWD	0001 to 9999	<i>ACD password</i> If the entry in subfield PSWDSEL is Y, datafill this refinement. Enter the ACD login password.
		see subfield	<i>Options</i> This field consists of subfield OPTION.

ACDENLOG (continued)**Field descriptions**

Field	Subfield	Entry	Explanation and action
	OPTION	MISGROUP, PAQ, VARWRAP, or FORCING (up to 4 options)	<p><i>Options list</i></p> <p>This field identifies the options that control the interval between call completion and new call presentation for incoming ACD calls. It also contains the option FORCING, which controls the delivery of the Call Forcing Tone to an agent's telephone.</p> <p>If only one, two, or three options are chosen, end the OPTION list with a \$. If four options are chosen, the list ends automatically.</p> <p>Enter MISGROUP to enable subpool to subpool password security enforcement if the wrap-up time (WRPTIME) of an agent is changed. Datafill refinement ACDGRP.</p> <p>Enter PAQ to control the number of call transfers each agent can have queued against the INCALLS key in the call transfer priority queue (CTQ). Datafill refinement PAQSIZE.</p> <p>Enter VARWRAP to assign a variable wrap-up time for each login ID. Datafill refinement WRPTIME.</p> <p>Enter FORCING to specify the delivery point at the agent's telephone for the Call Forcing tone, and datafill refinement TONE_DEST. Datafill for this option is ineffective if FORCING was not datafilled in table ACDGRP.</p>
	ACDGRP	alphanumeric (1 to 16 characters)	<p><i>Automatic call distribution group</i></p> <p>If the entry in subfield OPTION is MISGROUP, datafill this refinement. Enter an ACD group that is a member of the customer group that is datafilled in field CUSTGRP. If a customer group is not datafilled in field CUSTRGRP, the ACD group entered in option MISGROUP has no customer group restrictions at the time of datafill.</p> <p>Option MISGROUP must be datafilled; otherwise, the request to change an agent's WRPTIME is rejected.</p>

ACDENLOG (continued)**Field descriptions**

Field	Subfield	Entry	Explanation and action
	PAQSIZE	0 to 42	<p><i>Personal agent queue size</i></p> <p>If the entry in subfield OPTION is PAQ, datafill this refinement. Enter the number of calls an agent can have in the call transfer priority queue (CTQ) at any one time. Option PAQ must be datafilled for each login ID.</p>
	WRPTIME	0 to 600	<p><i>Wrap-up time</i></p> <p>If the entry in subfield OPTION is VARWRAP, datafill this refinement. Enter a value from 0 to 600 (in 1-s increments). This value enables a variable wrap-up time for each login ID so that specific agents have a different wrap-up time from the default wrap-up of the group they are logged into.</p>
	TONE_DEST	HSET, BASE, or NONE	<p><i>Call Forcing tone destination</i></p> <p>If the entry in subfield OPTION is FORCING, datafill this option. Enter the value HSET, BASE, or NONE to indicate the delivery point of the Call Forcing tone. The values have the following meanings:</p> <ul style="list-style-type: none"> • HSET specifies that the Call Forcing tone is delivered to the agent's telephone headset/handset. • BASE specifies that the Call Forcing tone is delivered to the agent's telephone speaker. • NONE specifies that the Call Forcing is not active for this agent and that the call must be answered manually. <p>The value enables agent selectivity for each login ID so that specific agents can have a call forcing tone delivery point different than the delivery point of the group they are logged into.</p> <p>Note: An agent's delivery point has precedence over a group's delivery point time as datafilled in field DWRPTIME in table ACDGRP.</p>

ACDENLOG (end)**Datafill example**

The following example shows sample datafill for table ACDENLOG.

MAP display example for table ACDENLOG

PARTNO	LOGINID	ACTIVATE	CUSTGRP PSWD	OPTIONS
252	02121	Y Y	CUSTGRPA Y 1234	(MISGROUP ACDGRP2)\$
114	01234	Y Y	CUSTGRPA Y 5555	(PAQ 5)\$
3	00004	Y Y	CUSTGRPA Y 1234	(VARWRAP 20)\$

Table history**SN07 (DMS)**

Activity A00004391 increased the table size to 30 000 tuples, and increased the range of field LOGINID to 30 000.

CR Q00854238 added entry NONE to option TONE_DEST.

APC007

The range for field PARTNO was changed from 0 to 256 to 0 to 1024.

NA004

The option FORCING was added.

BCS35

Table ACDENLOG was introduced.

ACDGRP

Table name

Automatic Call Distribution Group

Functional description

Table ACDGRP associates Automatic Call Distribution (ACD) features with specific customer groups.

Up to 1024 ACD groups can be assigned for each switch.

An entry in this table contains the following information for each ACD group:

- the name that is associated with this ACD group
- the operating company subscriber that owns this ACD group
- an ACD ringing threshold
- an overflow threshold route
- a night service route
- a priority promotion timer
- whether delayed billing applies
- the maximum number of calls in the incoming call queue at one time
- the maximum time that a call waits before being answered
- the options for ACD call park, agent association, announcement from original group after overflow, announcement or music during delay, configuration security, controlled directory number, default variable wrap-up time, display called about number, not ready on secondary directory number, management reports, observe agent warning tone, queue status lamps, queue to make set busy, recall notification, and other options
- the option for voice response units (VRU) or interactive voice responses (IVR) ports to access cutoff on disconnect (COD) for the IBN/2500 sets

Additional option information

If an ACD group has option controlled directory number (CDN) assigned, tuples cannot be added to that group.

Option 30VNS affects ACD groups on a per-node basis. Routed calls to ACD groups on other nodes are not affected. A busy tone results after ACD calls are rerouted three times from groups in overflow or night service mode to other ACD groups in overflow or night service mode.

ACDGRP (continued)

The deletion of option VRUGRP from table ACDGRP also deletes the COD option in table IBNLINES. The deletion of the COD option is for all entries for a distinct ACD group.

The following message displays with the addition of option VRUGRP in table ACDGRP.

```
WARNING: The VRUGRP option only supports IBN/2500 sets
configured as automated VRU/IVR agents. It does not support
live ACD agents.
```

Datafill sequence and implications

The following tables must be datafilled before table ACDGRP:

- at least one routing table (IBNRTE or OFRT)
- ACDMISPL (if feature ACDMIS is provided)
- ACDMISSP (if feature ACDMIS is provided)
- AUDIO (if option AUDIO is provided)
- CUSTHEAD
- NARDATA (if option NARS is provided)
- SCAIGRP (if option SCAIREDIR is provided)
- SDGRP (if feature MSQS or option QSL is provided)

Table size

Up to 1024 tuples

Datafill

The following table lists datafill for table ACDGRP.

Field descriptions

Field	Subfield	Entry	Explanation and action
ACDNAME		alphanumeric (1 to 16 characters)	Automatic Call Distribution (ACD) name. Enter the name that is assigned to the ACD group.
CUSTGRP		alphanumeric (1 to 16 characters)	Customer group name. Enter the customer group to which the ACD group belongs. This field is valid for a CDN ACD group.

ACDGRP (continued)**Field descriptions**

Field	Subfield	Entry	Explanation and action
ACDRNGTH		0 or 12 to 60	<p>ACD ringing threshold. Enter the maximum time (in seconds) that elapses before an unanswered call at an agent's phone has entered the call queue again at the head of the incoming call queue. After this time expires, the Make Set Busy feature is activated on the agent's position.</p> <p>Enter 0 (zero) if the call is not queued again.</p> <p>The default for a CDN ACD group is 0 (zero), which renders this field inactive.</p> <p>Note: A value from 1 to 11 is not a valid entry for this field.</p>
THROUTE		see subfields	<p>Threshold route. This field consists of subfields TABNAME and INDEX and specifies the route in table IBNRTE or table OFRT to which overflow ACD calls are routed.</p> <p>This field is not valid for a CDN ACDGRP.</p>
	TABNAME	TOPS, RRTE, IRTE, IBNRT2, IBNRT3, IBNRT4, IBNRTE, OFR2, OFR3, OFR4, or OFRT	<p>Table name. Enter the table name to which translation routes.</p> <p>IBNRT2, IBNRT3, IBNRT4, and OFR2, OFR3, OFR4, are extension tables of IBNRTE and OFRT respectively.</p> <p>Any entry outside the range indicated for this subfield is invalid.</p>
	INDEX	0 to 1023	<p>Index. Enter the number that is assigned to the route list in the table or tables to which translation routes. Zero (0) is an invalid entry for this subfield.</p>
NSROUTE		see subfields	<p>Night service route. This field consists of subfields TABNAME and INDEX. It specifies the Night Service route in the table to which all incoming calls are routed if there are no active agents in the ACD group.</p> <p>This field is not valid for a CDN ACDGRP.</p>

ACDGRP (continued)

Field descriptions

Field	Subfield	Entry	Explanation and action
	TABNAME	TOPS, RRTE, IRTE, IBNRT2, IBNRT3, IBNRT4, IBNRTE, OFR2, OFR3, OFR4, or OFRT	Table name. Enter the table name to which the translation routes. IBNRT2, IBNRT3, IBNRT4, and OFR2, OFR3, OFR4, are extension tables of IBNRTE and OFRT respectively. Any entry outside the range indicated for this subfield is invalid.
	INDEX	0 to 1023	Index. Enter the number that is assigned to the route list in the table to which the translation routes. Zero (0) is an invalid entry for this field.
PRIOPRO		0 to 255	Priority promotion timeout. Enter the maximum time (in seconds) that a call waits in a queue. Once this time has expired, the call is put into a queue of higher priority. Enter 0 (zero) if no timeout applies. This field is not valid for a CDN ACDGRP.
DBG		Y or N	Delayed billing. Delayed billing in table ACDGRP only applies for intraoffice. Enter Y (yes) to indicate that billing starts when the call is answered by an ACD agent. Enter N (no) to indicate that billing starts when the caller receives a recorded announcement. The default for a CDN ACD group is N (no), which renders this field inactive. Field DBG and office parameter ACD_TOLL_DELAYED_BILLING in table OFCENG control answer propagation.

ACDGRP (continued)**Field descriptions**

Field	Subfield	Entry	Explanation and action
MAXCQSIZ		0 to 511	<p>Maximum call queue size. Enter the maximum number of calls that can be in the incoming call queue at one time. After this threshold is reached, all subsequent calls are deflected to the route that is specified in field THROUTE. Enter 0 (zero) if the ACD group does not have call queuing capability.</p> <p>This field is valid for a CDN ACDGRP.</p>
MAXWAIT		0 to 1800	<p>Maximum waiting time. Enter the maximum time (in seconds) that a call must wait in the incoming call queue. After this number is reached, all subsequent calls are sent to the route that is specified in field THROUTE. Enter 0 (zero) if calls that cannot immediately terminate on an available agent position are to be rerouted to the overflow route specified in field THROUTE.</p> <p>This field is valid for a CDN ACDGRP.</p>

Additional features

Additional fields must be datafilled if any of the following features are provided in the switch:

- ACD Management Information (ACDMIS)
- Distinctive Ringing (DRING)
- Multistage Queue Status (MSQS)
- Observation Warning Tone (OBSWTONE)

If none of the these additional features are provisioned on the switch, go to field FRCNGTSV.

ACDGRP (continued)**Feature ACDMIS**

If ACD Management Information System (ACDMIS) is provided, datafill subfield ACDMIS, and refinements POOL, SUBPOOL, ACDVFG, VFG, MISOPT, and LOBVAL.

Field descriptions for conditional datafill

Field	Subfield	Entry	Explanation and action
ACDMIS		see subfield	Automatic Call Distribution Management Information System. This field is valid for a CDN ACDGRP.
	ACDMIS	Y or N	Enter Y to assign feature ACDMIS to this ACD group. Otherwise, enter N (no). The ACDMIS field is set to Y for the NACD group prior to adding the NORIMIS option.
	POOL	alphanumeric (1 to 16 characters)	Pool name. Enter the pool name. See table ACDMISPL.
	SUBPOOL	alphanumeric (1 to 16 characters)	Subpool name. Enter the subpool name. See table ACDMISSP.
	ACDVFG	Y or N	Automatic Call Distribution virtual facility group. Enter Y to assign feature ACDVFG to the ACD group and datafill refinement VFG. Otherwise, enter N and go to refinement MISOPTS. Option ACDVFG can only be selected if option ACDMIS has also been selected.
	VFG	alphanumeric (1 to 6 characters) (up to 3)	Virtual facility group. If the entry in refinement ACDVFG is Y, enter this refinement. Enter the virtual facility group to which the ACD group is linked.
	MISOPTS	see refinements	Management information system options. This refinement consists of refinement MISOPT and its refinements DEFLOB, NORIMIS, and WALKAWAY.

ACDGRP (continued)**Field descriptions for conditional datafill**

Field	Subfield	Entry	Explanation and action
	MISOPT	DEFLOB, NORIMIS, or WALKAWAY	<p>Enter DEFLOB for default line of business and datafill refinement LOBVAL.</p> <p>Enter NORIMIS to prevent the broadcast of resource index (RI) messages from a NACD group over the MultiProtocol Controller Link (MPC) to the MIS. The ACDMIS field is set to Y for the NACD group prior to adding the NORIMIS option.</p> <p>Enter WALKAWAY if the group has the ACD Walk-away feature. No further refinements for this feature are necessary. Go to field FRCNGTSV.</p>
	ENHWAC	Y or N	Enhanced Walkaway. If the entry in refinement MISOPT is WALKAWAY, enter Y to allow all the agents in the ACD group to change their walkaway reason in the not ready state. Enter N to disallow this functionality.
	LOBVAL	000 to 999	<p>Line of business value. If the entry in refinement MISOPT is DEFLOB, datafill this refinement. Enter the three-digit default line-of-business (LOB) value. This value is only sent if the LOB is not entered by the agent.</p> <p>Go to field FRCNGTSV.</p>

Feature MSQS

If the Multistage Queue Status (MSQS) feature is provided, datafill subfield MSQS and refinements T1, T2, T3, CHOICE, SDPOINTS, MSQS_DISP, and KEYLAMP.

ACDGRP (continued)

Field descriptions for conditional datafill

Field	Subfield	Entry	Explanation and action
MSQS		see subfields	Multistage queue status. This field is not valid for a CDN ACDGRP.
	MSQS	Y or N	Enter Y to assign feature MSQS to this ACD group and datafill refinements T1, T2, T3, CHOICE, SDPOINTS, and MSQS_DISP. Otherwise, enter N.
	T1	0 to 2400 or 5 to 2400	Threshold one. Enter a value between 0 and 2400 to indicate the number of calls (or the call queue threshold) to be exceeded. For example, entering a T1 value of 0 (zero) means that there must be at least one call in the call queue to indicate T1. The value of refinement T1 must be less than or equal to the value of refinement T2 when used as call queue threshold. Enter a value between 5 and 2400 to indicate the wait time for the oldest call threshold. The value of refinement T1 must be at least 5 s less than or equal to the value of refinement T2 when used as a wait threshold. Any entry outside the ranges indicated for this refinement is invalid.

ACDGRP (continued)**Field descriptions for conditional datafill**

Field	Subfield	Entry	Explanation and action
	T2	0 to 2400 or 5 to 2400	<p>Threshold two. Enter a value between 0 and 2400 to indicate the number of calls (or the call queue threshold) to be exceeded.</p> <p>For example, entering a T2 value of 4 means that there must be at least five calls in the call queue to indicate T2.</p> <p>The value of refinement T2 must be less than or equal to the value of refinement T3 when used as call queue threshold.</p> <p>Enter a value between 5 and 2400 to indicate the wait time for the oldest call threshold. The value of refinement T2 must be at least 5 less than or equal to the value of refinement T3 when used as a wait threshold.</p> <p>Any entry outside the ranges indicated for this refinement is invalid.</p>
	T3	0 to 2400 or 5 to 2400	<p>Threshold three. Enter a value between 0 and 2400 to indicate the number of calls (or the call queue threshold) to be exceeded.</p> <p>For example, entering a T3 value of 6 means there must be at least seven calls in the call queue to indicate T3.</p> <p>The value of refinement T3 must be greater than or equal to the value of refinement T2 when used as a call queue threshold.</p> <p>Enter a value between 5 and 2400 to indicate the wait time for the oldest call threshold. The value of refinement T3 must be at least 5 s greater than or equal to the value of refinement T2 when used as a wait threshold.</p> <p>Any entry outside the ranges indicated for this refinement is invalid.</p>
	CHOICE	CALLQ or WAIT	<p>Choice. Enter CALLQ to indicate that the status is determined by call queue size. Enter WAIT to indicate that the status is determined on the wait time of the call at the head of the incoming call queue.</p>

ACDGRP (continued)**Field descriptions for conditional datafill**

Field	Subfield	Entry	Explanation and action
	SDPOINTS	see refinements	Signal distribution points. This refinement consists of refinement SDSEL.
	SDSEL	Y or N	Signal distribution points. Enter Y to indicate that the signal distribution points are associated with this ACD group and datafill refinements SDGRP1, SDPT1, SDGRP2, SDPT2, SDGRP3, and SDPT3. Otherwise, enter N.
	SDGRP1	0 to 511	Signal distribution group number 1. Enter the hardware location of the signal distribution card in table SDGRP. This refinement is required if option MSQS is selected.
	SDPT1	0 to 6	Signal distribution point 1. Enter the number of the signal distribution card. It is assigned to the ACD group for option MSQS.
	SDGRP2	0 to 511	Signal distribution group number 2. Enter the hardware location of the signal distribution card in table SDGRP. It is required if option MSQS is selected.
	SDPT2	0 to 6	Signal distribution point 2. Enter the number on the signal distribution card. It is assigned to the ACD group for option MSQS.
	SDGRP3	0 to 511	Signal distribution group number 3. Enter the hardware location of the signal distribution card in table SDGRP. It is required if option MSQS is selected.
	SDPT3	0 to 6	Signal distribution point 3. Enter the number on the signal distribution card. It is assigned to the ACD group for option MSQS.
	MSQS_DISP	see refinements	Multistage queue display. This refinement consists of refinements DISPLAY and DINTRVL.
	DISPLAY	Y or N	Display selector. Enter Y to indicate that additional display information is displayed and datafill refinement DINTRVL. Otherwise, enter N.

ACDGRP (continued)**Field descriptions for conditional datafill**

Field	Subfield	Entry	Explanation and action
	DINTRVL	0 to 180	Display interval. Enter the interval (in seconds) between real-time updates of the MSQS threshold information display.
	KEYLAMP	see refinements	Key lamp. This refinement consists of refinements LAMP and LINTRVL.
	LAMP	Y or N	Lamp. This refinement selects the MSQS Key Lamp feature for a particular ACD group. Enter Y to select the MSQS Key Lamp feature that can be activated on any agent position equipped with a DQT key with an associated lamp and datafill refinement LINTRVL. Otherwise, enter N. The default value for this refinement is N. Go to field FRCNGTSV.
	LINTRVL	5 to 180	Lamp interval. This refinement indicates the interval (in seconds) between real-time updates of the status of the incoming call queue for the MSQS Key Lamp feature. The default value for this refinement is 20. Go to field FRCNGTSV.

Feature DRING

If the Distinctive Ringing (DRING) feature is provided, datafill field DISTRING.

Field descriptions for conditional datafill

Field	Subfield	Entry	Explanation and action
DISTRING		NONE, INBOUND, OUTBOUND, or BOTH	Distinctive Ringing. This field specifies whether Distinctive Ringing is applicable to inbound or outbound ACD calls in the ACD group, both inbound and outbound calls, or none of the ACD calls in the ACD group. This field is not valid for a CDN ACDGRP. Go to field FRCNGTSV.

ACDGRP (continued)

Feature OBSWTONE

If the Observation Warning Tone (OBSWTONE) feature is applied when a supervisor activates observation, datafill field OBSWTONE.

Field descriptions for conditional datafill

Field	Subfield	Entry	Explanation and action
OBSWTONE		Y or N	<p>Observation Warning Tone. Enter Y if the agent within this ACD group receives a warning tone when a supervisor activates observation. Otherwise, enter N.</p> <p>This field is not valid for a CDN ACDGRP.</p> <p>Go to field FRCNGTSV.</p>

All features

For all features, datafill the following fields.

Field descriptions for conditional datafill

Field	Subfield	Entry	Explanation and action
FRCNGTSV		see subfield	<p>Forced night service. The forced night service option prevents calls from remaining in a queue when night service has been activated. If this option is selected, incoming call queues are checked and calls are routed to the night service route or a clearing route defined by the customer.</p> <p>This field is not valid for a CDN ACDGRP.</p>
	FRCNGTSV	Y or N	<p>Enter Y (yes) to select option FRCNGTSV and datafill refinement CLR RTE. Otherwise, enter N (no).</p> <p>Note: Options QTOMSB and FRCNGTSV are mutually exclusive.</p>
	CLR RTE	see refinement	<p>Clearing route. This refinement consists of the refinement CLR RTE and its refinement CLRROUTE.</p>

ACDGRP (continued)**Field descriptions for conditional datafill**

Field	Subfield	Entry	Explanation and action
	CLRRTE	Y or N	Clearing route. If the entry in subfield. FRCNGTSV is Y, datafill this refinement. Enter Y if calls are deflected to the defined route in refinement CLRROUTE. Enter N if the calls are deflected to the Night Service route.
	CLRROUTE	see refinements	This refinement consists of refinements TABNAME and INDEX.
	TABNAME	TOPS, RRTE, IRTE, IBNRT2, IBNRT3, IBNRT4, IBNRTE, OFR2, OFR3, OFR4, or OFRT	Table name. Enter the table name to which the translation routes. IBNRT2, IBNRT3, IBNRT4, and OFR2, OFR3, OFR4, are extension tables of IBNRTE and OFRT respectively. Any entry outside the range indicated for this refinement is invalid.
	INDEX	1 to 1023	Index. Enter the number that is assigned to the route list in the table or tables to which translation routes. Zero (0) is not a valid entry for this refinement.
IDSIZE		4 or 5	Enter the maximum number of digits in an ACD agents' login for the group. For example, if the greatest login ID is 9999, enter 4; or if the greatest login ID is 10000 or more, enter 5. Different ACD groups can have different maximum numbers of agents.
OPTIONS		see subfield	Options. This field consists of subfield OPTION.

ACDGRP (continued)**Field descriptions for conditional datafill**

Field	Subfield	Entry	Explanation and action
	OPTION	3OVNS, ACDADMIN, ACDCPK, ACDDISP, ACDPSAP, ACDXFER, AGTASSN, AUDIO, CDN, CLDABTDSP, DASGRP, DMCT, FCS, FORCING, MAXCQLMT, MGTRPT, NARS, NETICM, NOANSWER, NONIMCUT, NRONSDN, OBSREST, ORGANN, OVFLINQ, QSL, QTOMSB, RENQTOUT, RCLNOTIF, SCAI, SCAIREDIR, SID, TIMECXR, TMDELOFL, VRUGRP or VARWRAP	<p>Option. This subfield contains the list of options and associated refinements that are assigned to the ACD group. Enter up to 24 of the following options. If less than 24 options are required, end the option list with a \$.</p> <p>Enter 3OVNS (three reroutes in overflow or night service) to enable ACD reroute chaining. This option allows calls to ACD groups in overflow or Night Service mode to reroute up to three times to other ACD groups in overflow or night service mode. This option is not compatible with option CDN.</p> <p>Enter ACDADMIN (configuration security) and datafill refinement ADMINGRP. This option is not compatible with option CDN.</p> <p>Enter ACDCPK (ACD call park) and datafill refinement CPRECALL. This option is not compatible with option CDN.</p> <p>Enter ACDDISP (ACD directory number [DN] name and number display) and datafill refinement DISPDIGS.</p> <p>Enter ACDPSAP (ACD public safety answering point) and datafill refinement ANONCALL. This option is not compatible with option CDN.</p>

ACDGRP (continued)**Field descriptions for conditional datafill**

Field	Subfield	Entry	Explanation and action
	OPTION (continued)		<p>Enter ACDXFER (ACD call transfer) and datafill refinements CTQSIZE and CTRECALL. This option is not compatible with option CDN.</p> <p>Enter AGTASSN (agent association) for the CompuCall Integration with ICCM feature to identify an ACD group by allowing the host application to associate on an individual basis.</p> <p>This option is not compatible with option CDN.</p> <p>Enter AUDIO (recorded announcement and music, or both) and datafill refinements RANTH, RINGING, and AUDIOGRP. This option is compatible with option CDN.</p> <p>Enter CDN (controlled DN) and datafill refinements DEFAULTGRP, RESPTM and CDN_THROUTE.</p> <p>Enter CLDABTDSP (display called about number) to display the called about number on the terminating ACD group agent set. The host computer sends the called about number in the TPC-ADD-PTY message.</p> <p>Note: You can also activate option CLDABTDSP for the ACD group when you add the tuple for the ACD group to table ACDGRP.</p>

ACDGRP (continued)

Field descriptions for conditional datafill

Field	Subfield	Entry	Explanation and action
	OPTION (continued)		<p>Enter DASGRP (Directory Assistance Service Group). When a caller dials the DAS number, the call is routed to the DAS ACD group. If an agent is not available, the call is queued subject to queue slot availability. If an agent is available, the call is presented to the agent. When the agent answers the call, the caller gives the necessary information to the agent. The agent sends a query to a database to retrieve the number.</p> <p>Enter DMCT (deny malicious call termination). This option must be assigned to the ACD group before it can be assigned to an agent in the group.</p> <p>Enter FCS (flexible charging system).</p> <p>Note: If option FCS is datafilled in field OPTION, option NOANSWER cannot be datafilled.</p> <p>Enter FORCING (ACD tone forcing optionality) and datafill refinement TONE_DEST. This option is not compatible with option CDN.</p> <p>Enter MAXCQLMT (maximum queue limit) and datafill refinement CQLMT. This option is not compatible with option CDN.</p> <p>Enter MGTRPT (management report interface). This option is not compatible with option CDN.</p> <p>Enter NARS (network access registers) and datafill refinement NARNAME. This option is not compatible with option CDN.</p>

ACDGRP (continued)**Field descriptions for conditional datafill**

Field	Subfield	Entry	Explanation and action
	OPTION (continued)		<p>Enter NETICM (network intelligent call management) to allow Network Intelligent Call Management functionality. Enter NOANSWER (no answer propagation).</p> <p>Note: Option NOANSWER is only valid for Japanese operating companies. If option NOANSWER is datafilled in subfield OPTION, option FCS cannot be datafilled as FCS always assumes that an answer is propagated to the network. It is crucial that option NOANSWER is datafilled consistently among related ACD groups to avoid inconsistency.</p> <p>Enter NONIMCUT (non-immediate cutoff). This option is not compatible with option CDN.</p> <p>Enter NRONSDN (not ready on secondary DN) and datafill refinement ENHNR. This option is not compatible with option CDN.</p> <p>Enter OBSREST (observe agent restricted). This option is not compatible with option CDN.</p>

ACDGRP (continued)

Field descriptions for conditional datafill

Field	Subfield	Entry	Explanation and action
	OPTION (continued)		<p>Enter ORGANN (announcement from original group after overflow). This option is not compatible with option CDN.</p> <p>Enter OVFLINQ (overflow line queue) and datafill refinements SERVICE, MAXVQSIZ, and MAXVQLMT. This option is not compatible with option CDN.</p> <p>Enter QSL (queue-status lamps) and datafill refinements SDGRPNO and SDPOINT. This option is not compatible with option CDN.</p> <p>Enter QTOMSB (queue to Make Set Busy). This option is not compatible with option CDN.</p> <p>Note: QTOMSB is applicable only to Base ACD. It has no functionality in Network ACD (NACD) groups. QTOMSB queues calls to an ACD Group with all agents in MSB. If QTOMSB is not datafilled in subfield OPTION, calls to a group with all agents logged out or no agents datafilled are rerouted as specified in field NSROUTE.</p> <p>Enter RENQTOUT to specify an optional routing for an ACD re-enqueued call.</p> <p>Enter RCLNOTIF (recall notification) for enhanced recall notification. This entry allows any agent within the ACD group presented with a recalled ACD call to receive recall notification. This option is not compatible with option CDN.</p> <p>Enter SCAI (switch computer application interface).</p> <p>Enter SCAIREDIR (extended call management (ECM) call redirection on ACD group basis) and datafill refinements MSGTO, NCOS, and BILLDN. This option is not compatible with option CDN.</p> <p>Enter SID (specified calling identification) to include the caller identification in the outgoing message.</p>

ACDGRP (continued)**Field descriptions for conditional datafill**

Field	Subfield	Entry	Explanation and action
	OPTION (continued)		<p>Enter TMDELOFL (time delay overflow) and datafill refinements TIME and OFLTYPE. This option is not compatible with option CDN.</p> <p>Enter TIMECXR (ACD call transfer with time). This option is not compatible with option CDN.</p> <p>Enter VARWRAP (default variable wrap-up time) and datafill refinement DWRPTIME. This option is not compatible with option CDN.</p> <p>Enter VRUGRP (voice response unit group). The option VRUGRP allows an ACD group with voice response units (VRU) or interactive voice responses (IVR) access to the COD (Cutoff on Disconnect) functionality.</p>

OPTION = ACDDISP

If the entry in subfield OPTION is ACDDISP, datafill refinement DISPDIGS as follows.

Field descriptions for conditional datafill

Field	Subfield	Entry	Explanation and action
	DISPDIGS	0 to 10	Display digits. Enter the number of ACD DN digits that display by the option.

OPTION = ACDADMIN

If the entry in subfield OPTION is ACDADMIN, datafill refinement ADMINGRP as follows.

Field descriptions for conditional datafill

Field	Subfield	Entry	Explanation and action
	ADMINGRP	1 to 255	Administration group. Enter the ACD administration group number that is associated with this ACD group.

ACDGRP (continued)

OPTION = ACDCPK

If the entry in subfield OPTION is ACDCPK, datafill refinement CPKRECALL as follows. If ACDPRK is datafilled against an ACD group, then calls can be parked against any valid DN within the customer group.

Field descriptions for conditional datafill

Field	Subfield	Entry	Explanation and action
	CPKRECALL	Y or N	Call park recall. Enter Y to select the call park recall timer and datafill refinement CPKRTMR. Otherwise, enter N.
	CPKRTMR	12 to 240	<p>Call park recall timer. This timer recalls a parked call that is not answered within a specified time to either the agent who initiated the call park request or to the ACD group incoming call queue.</p> <p>Enter a value (in seconds) that specifies the time limit within which a call must be answered.</p> <p>Any entry outside the range indicated for this field is invalid.</p> <p>Note: CPKRTMR takes precedence over the call park recall timer in table CUSTSTN.</p>

ACDGRP (continued)**OPTION = ACDPSAP**

If the entry in subfield OPTION is ACDPSAP, datafill refinements are as follows.

Field descriptions for conditional datafill

Field	Subfield	Entry	Explanation and action
	ANONCALL	Y or N	Anonymous call. Enter Y to indicate that calls are allowed to terminate at the public safety answering point (PSAP). Otherwise, enter N.
	ENHDISP	Y or N	Enhanced display. Enter Y to turn on the wireless protocol two-line display for PSAPs. Otherwise, enter N. Note: For LDT PSAPs: If the ANISPILL option is set to Y, the user receives the prompt for the ENHDISP option. If the ENHDISP option is set to Y, the NUMIDIGS option is turned off.
	NPD_MAPS	Vector of <NPD, SNPA>	Numbering plan digit mapping. Enter up to four mappings for each ACD PSAP. Terminate the entry any time before entering the fourth pair by entering a nil vector (“\$”). If the user enters the nil vector for the first pair, the ACD PSAP has no individual mappings. In this case, the ACD PSAP uses table E911NPD when an NPD is needed. If no pairs are present, this option is off. Note: Do not enter an NPD more than once for a PSAP. Do not map an SNPA to more than one NPD for each PSAP.
	NPD	0, 1, 2, 3	Numbering plan digit. Enter the NPDs in any order.

ACDGRP (continued)**Field descriptions for conditional datafill**

Field	Subfield	Entry	Explanation and action
	SNPA	SERVING_ NUMBERING_ PLAN_AREA	Serving numbering plan area. Assign the SNPA to any of the first set of NPDs (0 through 3). Note: Invalid NPD or SNPA entries cause errors. Do not map an SNPA to more than one NPD for each PSAP. A PSAP does have to have all four NPD mappings defined.
	NATLXLA	Y or N	If entry is 'Y', call translations to this PSAP are based on 10 digits (with NPA). The PSAPDN field in table E911PSAP is datafilled with 10 digits. If entry is 'N', call translations are based on 7 digits (without NPA). The PSAPDN field is datafilled with 7digits.

OPTION = ACDXFER

If the entry in subfield OPTION is ACDXFER, datafill refinements CTQSIZE, CTRECALL, CXRRECALL, and XFERTMR as follows.

Field descriptions for conditional datafill

Field	Subfield	Entry	Explanation and action
	CTQSIZE	0 to 42	Call transfer queue size. Enter the number of calls that can reside in the call transfer queue.
	CTRECALL	see refinement	Call transfer recall. This refinement consists of the refinement CXRRECALL.

ACDGRP (continued)**Field descriptions for conditional datafill**

Field	Subfield	Entry	Explanation and action
	CXRRECALL	Y or N	Transferred call recall. Enter Y to indicate that a transferred call that is not answered within a specific length of time is recalled and datafill refinement XFERTMR. Enter N if the transferred call is not recalled.
	XFERTMR	12 to 120	Transferred call recall timer. Enter the time (in seconds) within which a transferred call must be answered. If the call is not answered within the specified time, the recall timer transfers the call back to the agent who initiated the transfer request. Note: XFERTMR takes precedence over the call transfer recall timer in table CUSTSTN.

ACDGRP (continued)**OPTION = AUDIO**

If the entry in subfield OPTION is AUDIO, datafill refinements RANTH, RINGING, and AUDIOGRP as follows.

Field descriptions for conditional datafill

Field	Subfield	Entry	Explanation and action
	RANTH	0 or 6 to 60	<p>Enter 0 (zero) or 6 to 60 if field RINGING contains a value of N. A value of 0 (zero) in this field and a value of N in field RINGING means that callers receive an announcement immediately.</p> <p>Enter 0 (zero) or 6 to 60 if field RINGING contains a value of N. A value of 0 (zero) in this field and a value of N in field RINGING means that callers receive an announcement immediately.</p> <p>Zero (0) is not a valid entry if field RINGING is set to Y.</p>
	RINGING	Y or N	<p>Ringling. Enter Y to indicate that ringing is given to calls that are not answered before the time that is specified in field RANTH has expired and an announcement is given.</p> <p>Enter N to indicate that queued calls receive an announcement or music either immediately (0 in field RANTH) or after the time specified in field RANTH has expired.</p>
	AUDIOGRP	AUDIO1 to AUDIO512	<p>Audio group. Enter the audio group that is datafilled in table AUDIO where option ACDQ specifies the announcement or music that is applied to calls.</p>

ACDGRP (continued)**OPTION = CDN**

If the entry in subfield OPTION is CDN, datafill refinements DEFAULTGRP, RESPTM, and CDN_THROUTE as follows.

Field descriptions for conditional datafill

Field	Subfield	Entry	Explanation and action
	DEFAULTGRP	ACD group name	Default ACD group. Enter this refinement along with option CDN. A call in the CDN queue is routed to the default ACD group when no routing instructions or treatment response is received from ICCM within the ICCM response time. To set the ICCM response time, see refinement RESPTM.
	RESPTM	1-60 seconds	ICCM response time. Enter this refinement to set the ICCM response time.
	CDN_THROUTE	Y or N	Option CDN_THROUTE. Set option CDN_THROUTE to Y to route the call to THROUTE when the incoming call queue is full. Set option CDN_THROUTE to N to route the call to the default ACD group.

ACDGRP (continued)**OPTION = FORCING**

If the entry in subfield OPTION is FORCING, datafill refinement TONE_DEST as follows.

Field descriptions for conditional datafill

Field	Subfield	Entry	Explanation and action
	TONE_DEST	HSET, BASE, or NONE	<p>Call Forcing tone destination. Enter the value HSET, BASE, or NONE to indicate the delivery point of the Call Forcing tone. The values have the following meanings:</p> <ul style="list-style-type: none"> • HSET specifies that the Call Forcing tone is delivered to the telephone headset/handset of all agents in this group. • BASE specifies that the Call Forcing tone is delivered to the speaker of all agents in this group. • NONE indicates that Call Forcing is available to agents in this group. Call Forcing is available through customized datafill in table ACDLOGIN or table ACDENLOG. A default is not available.

OPTION = MAXCQLMT

If the entry in subfield OPTION is MAXCQLMT, datafill refinement CQLMT as follows.

Field descriptions for conditional datafill

Field	Subfield	Entry	Explanation and action
	CQLMT	0 to 511	Maximum value MAXCQSIZ. Enter the maximum value to which MAXCQSIZ can be changed using table control or load management.

ACDGRP (continued)**OPTION = NARS**

If the entry in subfield OPTION is NARS, datafill refinement NARNAME as follows.

Field descriptions for conditional datafill

Field	Subfield	Entry	Explanation and action
	NARNAME (BCS36-)	alphanumeric (up to 16 characters) or NILNAR	Network access registers name. Enter the network access registers (NAR) that the call must have access through to continue. The entry for this refinement must be previously datafilled in table NARDATA. Enter NILNAR if no NAR is required.

OPTION = NRONSDN

If the entry in subfield OPTION is NRONSDN, datafill refinement ENHNR as follows.

Field descriptions for conditional datafill

Field	Subfield	Entry	Explanation and action
	ENHNR	Y or N	Enhanced not ready. Setting subfield ENHNR to Y, activates the Enhanced Not Ready feature and places the agent in the not ready state when a call originates/terminates to an SDN on the agent's set. If the subfield ENHNR is set to N, this enhancement will not be activated, and the agent is placed in the not ready state for outgoing calls. When ENHNR is set to N, the NRONSDN feature functions in the original way.

ACDGRP (continued)

OPTION = OVFLINQ

If the entry in subfield OPTION is OVFLINQ, datafill refinements SERVICE, MAXVQSIZ, and MAXVQLMT as follows.

Field descriptions for conditional datafill

Field	Subfield	Entry	Explanation and action
	SERVICE	OLDEST, OVFLIN, or P0FIRST	<p>Service. This field determines whether calls that have overflowed to the ACD group are serviced before or after priority 0 calls.</p> <p>Enter OLDEST if the oldest call of the overflow out, overflow in, and priority queues is served first.</p> <p>Enter OVFLIN if incoming overflowed calls are served before priority 0 calls.</p> <p>Enter P0FIRST if priority 0 calls are served before other incoming overflowed calls.</p>
	MAXVQSIZ	0 to 511	<p>Maximum value for overflow queue size. Enter the maximum number of calls that can exist in the overflow queue at one time.</p>
	MAXVQLMT	Y or N	<p>Maximum value for overflow queue limit. Enter Y if a maximum value for the overflow queue can be changed and datafill refinement VQLMT. Otherwise, enter N.</p>
	VQLMT	0 to 511	<p>Maximum value MAXVQSIZ. Enter the maximum value to which MAXVQSIZ can be changed using table control or load management.</p>

ACDGRP (continued)**OPTION = QSL**

If the entry in subfield OPTION is QSL, datafill refinements SDGRPNO and SDPOINT as follows.

Field descriptions for conditional datafill

Field	Subfield	Entry	Explanation and action
	SDGRPNO	0 to 511	Signal distribution group number. Enter the number of the signal distribution (SD) group that defines the hardware location of the SD card in table SDGRP.
	SDPOINT	0 to 6	Signal distribution point. Enter the SD point number of the SD card.

OPTION = RENQTOUT

If the entry in subfield OPTION is RENQTOUT, assign refinement TIME as follows.

Field descriptions for conditional datafill

Field	Subfield	Entry	Explanation and action
	TIME	0 to 1800	Time. Enter the re-enqueue time value for the ACD group. If the re-enqueue time value is 0, the re-enqueued call for that ACD group will not have the enhanced re-enqueue routing feature.

OPTION = SCAIREDIR

If the entry in subfield OPTION is SCAIREDIR, datafill refinements MSGTO, NCOS, and BILLDN as follows.

Note: Option SCAIREDIR has no effect unless table SCAIGRP has been datafilled before table ACDGRP and the ACD has logged on to a switch

ACDGRP (continued)

computer application interface (SCAI) session that has subscribed to the DV-Call Received and DV-Call Redirect messages.

Field descriptions for conditional datafill

Field	Subfield	Entry	Explanation and action
	MSGTO	1 to 30	Receive message timeout value. Enter the required timeout value (in seconds) for a host computer's response to a message that requires confirmation.
	NCOS	0 to 511	Network class of service. The NCOS value is used to translate and route redirected calls. The NCOS must be datafilled on an ACD group basis and must be valid for the ACD group's Meridian Digital Centrex (MDC) customer group datafilled in table NCOS. The default value for this field is 0 (zero).
	BILLDN	vector of up to 11 digits, or N or \$	Billing directory number. Enter the billing number used by extended call management (ECM) call redirection if the redirected leg of the call is billable or Station Message Detail Recording (SMDR) applies. The BILLDN can be a value of 0 to 11 digits or N. Zero (0) digits (\$ input), or N, indicates that a default billing number is used (\$ and N mean the same thing.) The default billing number for ECM call redirection is the ACD DN reached by the caller immediately prior to the redirection attempt. The default value for this field is N.

OPTION = SID

If the entry in the OPTION subfield is SID, enter datafill as follows.

Field descriptions for conditional datafill

Field	Subfield	Entry	Explanation and action
	SID	numeric string	Specified calling identification. Enter the SID of the calling party in the SID subfield. The number must be between 0 and 11 digits in length. The SID prevents the terminating party from calling back the SDN of an ACD agent.

ACDGRP (continued)**OPTION = TMDELOFL**

If the entry in subfield OPTION is TMDELOFL, datafill refinements TIME, and OFLTYPE_SEL as follows.

Field descriptions for conditional datafill

Field	Subfield	Entry	Explanation and action
	TIME	0 to 1800	Time. Enter the time (in seconds) that a call waits in the incoming call queue before being rerouted to the second ACD group. If 0 (zero) is datafilled, the call is rerouted immediately. The maximum wait time for a call is 30 minutes. Nortel Networks recommends a value of 520 seconds.
	OFLTYPE_SEL	ALLPRIO or PRI0ONLY	Overflow type selector. Enter ALLPRIO to indicate that the time delay overflow applies to all priority calls. Enter PRI0ONLY to indicate that the time delay overflow applies to priority 0 (zero) calls only and datafill refinement START.
	START	IMMEDIAT or P0ONLY	Start. If the entry in refinement OFLTYPE is PRI0ONLY, datafill this refinement to indicate when timing begins for a call. Enter P0ONLY to indicate that timing starts when a call reaches priority 0 (zero). Enter IMMEDIAT to indicate that timing begins when the call is first enqueued, regardless of its priority.

OPTION = VARWRAP

If the entry in subfield OPTION is VARWRAP, datafill refinement DWRPTIME as follows.

Field descriptions for conditional datafill

Field	Subfield	Entry	Explanation and action
	DWRPTIME	0 to 600	Default variable wrap-up time. Enter the interval (in seconds) between call completion and presentation of new incoming ACD calls.

ACDGRP (continued)

Datafill example

An example of datafill for table ACDGRP with field FRCNGTSV but without field CLRRTE follows. The table ACDGRP example for ACDGRP1 includes option VRUGRP.

MAP display example for table ACDGRP

```

ACDNAME  CUSTGRP  ACDRNGTH  THROUTE  NSROUTE
          PRIOPRO  DBG      MAXCQSIZ  MAXWAIT  ACDMIS
          MSQS    DISTRING  OBSWTONE  FRCNGTSV  IDSIZE
OPTIONS
-----
COMLNACD1  COMKODAK    20      IBNRTE 1  IBNRTE 2
           30      N      2      15      N
N      NONE      Y      N      4
(ACDDISP 7) (TMDELOFL 30 ALLPRIO )
(OVFLINQ OVFLIN 5 Y 10) (NONIMCUT ) $

ACDGRP1  BNR 12 OFRT 99 IBNRTE 99 2 N 20 20 Y MIS1 MIS1SUB
N $ N NONE N N      5
(NETICM) (VRUGRP) $
    
```

Note: The deletion of option VRUGRP from table ACDGRP also deletes the COD option in table IBNLINES. The deletion of the COD option is for all entries for a distinct ACD group.

An example of datafill for table ACDGRP showing the use of the DASGRP option in the OPTIONS field.

MAP display example for table ACDGRP

```

ACDNAME      CUSTGRP  ACDRNGTH      THROUTE
              NSROUTE  PRIOPRO  DBG  MAXCQSIZ  MAXWAIT
                                      ACDMIS
                                      MSQS  DISTRING  OBSWTONE
              FRCNGTSV  IDSIZE
                                      OPTIONS
-----
ACDTEST1      IBNTST      12      OFRT  41
              OFRT  43      0  N      1      256
                                      N
              N      4
                                      ( DASGRP ) $
    
```

ACDGRP (continued)

Table history**SN07 (DMS)**

Option TONE_DEST entry NONE updated for Q00854238.

Activity A00004391 added field IDSIZE.

CSP17

CR Q00581317 modified the description of the QTOMSB entry in the OPTIONS field.

ISN04 (TDM)

Feature 59035660, DA Service Integration and Billing Delay, introduces the entry DASGRP into the OPTIONS field.

NA015

Feature 59022576, ICM CDN Display and Threshold Route Enhancements, removes restrictions and allows the agent to display the name and number of the dialed party, if option ACDDISP is given for agents ACD GROUP. This enhancement also allows the ACD groups, with option CDN, to route calls to a threshold route (THROUTE). This feature also adds field CDN_THROUTE.

NA014

Feature 59016864, ACD Not Ready on Secondary DN Enhancement, enhances the original NRONSDN option that addresses an outgoing call. This enhancement places an agent in the not ready state when an incoming call is answered on an SDN. This feature adds the NRONSDN subfield ENHNR.

NA012

Feature 59006893, Provisioning for Enhanced Multi-NPA, adds a field NATLXLA to option ACDPSAP to support seven- and ten-digit call translations.

APC011

This release adds the SID option to the OPTIONS field for feature AU3381.

NA011

This release changes table ACDGRP as follows:

- adds option VRUGRP to subfield OPTION for feature AU3195
- adds option ENHWAC to subfield MISOPTS for feature AF7737
- adds option RCLNOTIF to subfield OPTION for feature AF7735

ACDGRP (continued)

NA010

This release changes table ACDGRP as follows:

- adds option NETICM to subfield OPTION for feature AU2799
- changes refinement OFLTYPE to OFLTYPE_SEL in subfield OPTION = TMDELOFL

NA009

This release changes table ACDGRP as follows:

- adds option ENHDISP to subfield OPTION = ACDPSAP for feature AF7232
- adds options NPD_MAPS, NPD, and SNPA to subfield OPTION = ACDPSAP for feature AF7233
- adds option CLDABTDSP and option RENQTOUT to subfield OPTION for feature AF7227

NA008

This release makes the following changes to table ACDGRP:

- adds option CDN to subfield OPTION in accordance with the CompuCALL Integration with ICCM feature (AU2339)
- adds option AGTASSN to subfield OPTION in accordance with the CompuCALL Integration with ICCM feature (AU2339)
- adds option NORIMIS to the MIS options list of table ACDGRP for feature AF6824

NA007

This release updates the maximum entries in table ACDGRP to 1024.

NA006

This release updates values for field NCOS in accordance with the Intra-LATA PIC Enhancements and the TL changes for LINEATTR, NCOS, and LTG Table Expansion features.

NA005

This release adds the option 3OVNS to subfield OPTION.

NA004

This release adds option FORCING and its refinements to subfield OPTION in table ACDGRP.

ACDGRP (end)

BCS36

This release makes the following changes to table ACDGRP:

- adds options DMCT and NARS to subfield OPTION
- adds refinement NARNAME
- corrects entry values in refinements RANTH and RINGING for OPTION AUDIO
- corrects entry values in all three occurrences of field TABNAME
- changes entry values and explanatory text for and added a warning preceding fields T1, T2, and T3

ACDLOGIN

Table name

Automatic Call Distribution Login ID Password Table

Functional description

Table ACDLOGIN maps Automatic Call Distribution (ACD) login identifications (ID) to a corresponding password and maps customer groups to corresponding ACD login IDs. ACD agent logins are screened through customer group restrictions and password associations that are based on the agent login ID of the ACD agent. Table ACDLOGIN is also used to assign screening restrictions.

Feature Make Set Busy (MSB) must be deactivated before an agent attempts to login. If the agent login ID is found in table ACDLOGIN and if subfield CUSTSEL is set to Y (yes), the customer group that is associated with that particular agent login ID is checked against the customer group of the INCALLS key of the agent's set. If there is no match, the reorder tone is given. If subfield CUSTSEL is set to N (no), but the agent login ID appears in table ACDLOGIN, the login procedure continues with no further checks.

If subfield CUSTSEL is set to Y and the customer groups match, table ACDLOGIN is rechecked to see if a password is associated with this agent login ID. If subfield PSWDSEL is set to Y, the agent receives a special dial tone. The agent must then enter a four-digit number, from 0001 to 9999. The password is not displayed.

The agent receives the reorder tone if an incorrect password is entered, or if the agent login ID has already been used by another agent. If subfield PSWDSEL is set to N, the special dial tone is not received by the agent and the normal login procedure continues.

If all the checks are passed and if ACDNR in table KSETLINE has been datafilled for the agent, the ACD INCALLS lamp and MSB lamp are extinguished. The ACDNR lamp is then lit and the agent is placed in the ACD Not Ready queue. The agent must deactivate ACD Not Ready in order to receive ACD calls.

The password of a specific agent login ID can be displayed using parameter LOGINID of the command interpreter (CI) command ACDSHOW. The passwords datafilled in table ACDLOGIN are not necessarily unique. The same password can be used by several agents. The same password can be assigned to all agents in the same group or subgroup.

ACDLOGIN (continued)**Datafill sequence and implications**

The following tables must be datafilled before table ACDLOGIN:

- CUSTHEAD
- ACDGRP

Table size

0 to 30 000 tuples

Datafill

The following table lists datafill for table ACDLOGIN.

Field descriptions

Field	Subfield	Entry	Explanation and action
LOGINID		see subfield	<i>Automatic call distribution login ID</i>
	LOGINID	00001 to 30000	Enter the Automatic Call Distribution (ACD) agent login identification (ID). Any entry outside the range indicated for this field is invalid.
CUSTGRP		alphanumeric (1 to 16 characters)	<i>Customer group</i> Enter the name of the customer group that is associated with the login ID.
	CUSTSEL	Y or N	<i>Customer group selector</i> Enter Y (yes) if the customer group that is associated with the agent login ID is checked for a match with the customer group of the INCALLS key of the set that is logging in. Datafill refinement CUSTGRP. Otherwise, enter N (no) and datafill field PSWD.
	CUSTGRP	alphanumeric (1 to 16 characters)	<i>Customer group</i> If the entry in field CUSTSEL is Y, datafill this refinement. Enter the name of the customer group associated with this login ID.
PSWD		see subfield	<i>ACD password</i> This field consists of subfield PSWDSEL.
	PSWDSEL	Y or N	<i>Password selector</i> Enter Y if a password is required during the login procedure and datafill refinement PSWD. Otherwise, enter N and go to field OPTIONS.

ACDLOGIN (continued)**Field descriptions**

Field	Subfield	Entry	Explanation and action
	PSWD	0001 to 9999	<p><i>ACD password</i></p> <p>If the entry in subfield PSWDSEL is Y, datafill this refinement. Enter the ACD login password.</p> <p>Any entry outside the range indicated for this field is invalid.</p>
OPTIONS		see subfield	<p><i>Options</i></p> <p>This field consists of subfield OPTION.</p>
	OPTION	MISGROUP, PAQ, VARWRAP, or FORCING (vector of up to 4 options)	<p><i>Options list</i></p> <p>This field identifies the options that control the interval between call completion and new call presentation for incoming ACD calls. It also contains the option FORCING, which controls the delivery of the Call Forcing tone to an agent's telephone.</p> <p>If one, two, or three options are chosen, end the option list with a \$. If four options are chosen, the list ends automatically.</p> <p>Enter MISGROUP to enable subpool-to-subpool password security enforcement if the wrap-up time of an agent is changed. Datafill refinement ACDGRP.</p> <p>Enter PAQ to control the number of call transfers each agent can have queued against the INCALLS key in the call transfer priority queue (CTQ). Datafill refinement PAQSIZE.</p> <p>Enter VARWRAP to assign a variable wrap-up time for each login ID and datafill refinement WRPTIME.</p> <p>Enter FORCING to specify the delivery point at the agent's telephone for the Call Forcing tone, and datafill refinement TONE_DEST. Datafill for this option is ineffective if FORCING was not datafilled in table ACDGRP.</p>

ACDLOGIN (continued)

Field descriptions

Field	Subfield	Entry	Explanation and action
	ACDGRP	alphanumeric (1 to 16 characters)	<p><i>ACD group</i> If the entry in subfield OPTION is MISGROUP, datafill this refinement. Enter an ACD group that is a member of the customer group datafilled in field CUSTGRP. If a customer group is not datafilled in field CUSTGRP, the ACD group entered in field ACDGRP has no customer group restrictions at the time of datafill.</p> <p>MISGROUP must be datafilled in field OPTION; otherwise, the request to change an agent's wrap-up time is rejected.</p>
	PAQSIZE	0 to 42	<p><i>Personal agent queue size</i> If the entry in subfield OPTIONS is PAQ, datafill this refinement. Enter the number of calls an agent can have in the call transfer priority queue at any one time. Option PAQ must be datafilled for each login ID.</p>

ACDLOGIN (continued)**Field descriptions**

Field	Subfield	Entry	Explanation and action
	WRPTIME	0 to 600	<p><i>Wrap-up time</i></p> <p>If the entry in subfield OPTION is VARWRAP, datafill this option. Enter a value between 0 (zero) and 600 (in 1-s increments). The value enables a variable wrap-up time for each login ID so that specific agents have a wrap-up time different from the default wrap-up of the group they are logged into.</p> <p>Note: An agent's wrap-up time has precedence over a group's wrap-up time as datafilled in field DWRPTIME in table ACDGRP.</p>
	TONE_DEST	HSET, BASE, or NONE	<p><i>Call Forcing tone destination</i></p> <p>If the entry in subfield OPTION is FORCING, datafill this option. Enter the value HSET, BASE, or NONE to indicate the delivery point of the Call Forcing tone. The values have the following meanings:</p> <ul style="list-style-type: none"> • HSET specifies that the Call Forcing tone is delivered to the agent's telephone headset/handset. • BASE specifies that the Call Forcing tone is delivered to the agent's telephone speaker. • NONE specifies that Call Forcing is not enabled on this agent's telephone. <p>The value enables agent selectivity for each login ID so that specific agents can have a call forcing tone delivery point different than the delivery point of the group they are logged into.</p> <p>Note: An agent's delivery point has precedence over a group's delivery point time as datafilled in field DWRPTIME in table ACDGRP.</p>

Datafill example

The following example shows sample datafill for table ACDLOGIN.

ACDLOGIN (continued)

MAP display example for table ACDLOGIN

LOGINID	CUSTGRP	PSWD	OPTIONS
00001 Y	E911 Y	1111	(VARWRAP 20) (PAQ 5) (FORCING BASE) \$

Table history

SN07 (DMS)

Activity A00004391 increased the table size to 30 000 tuples, and increased the range of field LOGINID to 30 000. CR Q00854238 added entry NONE to option TONE_DEST.

NA004

The option FORCING was added.

BCS36

Corrected range of values for fields LOGINID and PSWD and corrected information in section "Datafill sequence".

ACDMISPL

Table name

Automatic Call Distribution MIS Pool

Overview

The Automatic Call Distribution (ACD) Management Information System (ACDMIS) interface provides protocols that enable a down stream processor (DSP) to request ACD information. The system collects and uses this information to provide historical reports or real-time statistics.

Although the system sends the ACD information as soon as possible, heavy switch traffic can delay transmission.

ACD call event messages include information on all ACD calls that the system offers, answers, abandons, releases, or blocks.

ACD position event messages provide information on agent-related events. ACD subpool data messages include information on mapping from an internal subpool number to a subpool common language location identifier (CLLI).

ACD group data messages provide information on mapping from an internal ACD group number to an ACD group CLLI and primary ACD_DN. In addition, ACD group data messages provide information on the current attributes of the ACD group.

You can use the ACDMIS interface to do the following tasks:

- use session control remote operations (RO) to log on to or log off from a session
- specify a pool of ACD groups targeted for event information collection or change in a session
- request to transmit the ACD configuration of the pool associated with the switched virtual circuit (SVC) to the DSP
- request the current date and time of day (TOD) from the switch
- start and stop the transfer of ACD call event information

ACDMIS Message Bundling is an option that combines multiple event messages within a single MIS message packet before transmission. Message bundling increases message throughput over the X.25 enhanced multiprotocol controller (EMPC) link by up to 100%.

ACDMISPL (continued)

Data links

X.25-based communication links are used for two-way data transportation between the DSP and the switch. X.409- and X.401-based network operations protocol (NOP) provides application protocol for machine-to-machine interface.

ACDMIS data stream protocol

The DSP and the switch communicate through ROs. The NOS_LOGON command sent by the DSP establishes a session. When the switch receives a NOS_LOGON request, the system allocates incoming and outgoing message buffers and creates an incoming message process.

The incoming message buffer stores DSP command requests that are waiting for processing. This buffer can contain up to ten remaining DSP command requests.

The outgoing message buffer stores DSP replies and ACDMIS command requests. This buffer can contain up to 150 remaining replies and ACDMIS command requests.

The incoming message process stops the DSP command requests from the buffer and calls the application to process the commands. This process is idle when the buffer is empty.

When the RO service receives a DSP command request, it decodes the message according to the application specification. Then the request is queued in the incoming message process.

The following information defines protocol services:

- when features are supported by each of the remote operations
- when remote operations are active
- when parameters are required

The ACDMIS Remote Operations are categorized as follows:

- An RO prefixed with Network Operations System (NOS) is a session control RO sent from the DSP to the switch.
- An RO prefixed with DSP is sent from the DSP to the switch to enable functionality for the DSP, like an MIS initiated request.
- An RO prefixed with SWITCH is sent from the switch to the DSP to enable functionality to the switch, like a switch initiated request.

ACDMISPL (continued)

No more than ten ROs generated by the DSP requiring a reply from the switch can be outstanding without a response at any time. If the DSP generates another RO requiring a reply, the switch cancels the X.25 session.

A reject operation protocol data unit (OPDU) can be sent in response to any of the ROs outlined in this protocol.

Protocol version BCS43 enables the ACDMIS to use certain remote load management request messages, event messages, and modified call event messages.

ACDMIS data stream requirements

The ACDMIS data stream protocol supports the following configurations:

- multiple ACDMIS data streams on each switch and each data stream on its own SVC
- multiple ACD customers for each data stream and multiple ACD customers for each SVC
- one ACD customer for each data stream and one ACD customer for each SVC

The ACDMIS data stream protocol is not required to support multiple data streams for each SVC.

The ACDMIS uses the X.409 formal notation and X.410 ROs for protocols.

An X.25 SVC is a virtual communication link, which is all or part of an actual physical communication link. The switch and the DSP use protocol commands to communicate with each other.

Before multiple ACDMIS data streams can be established in the switch, the ACD configuration must be partitioned between data streams. The ACD groups must be associated with a data stream. This association is necessary in order to establish the data stream in which the switch can send information for a particular ACD group.

Partitioning

The ACD groups can be partitioned between different data streams by defining pools of ACD groups within the switch. Guidelines for partitioning pools are as follows:

- An ACD group can only belong to one pool at a time.
- A pool can only be associated with one data stream at a time.

ACDMISPL (continued)

- Only one pool of ACD groups can be associated with a data stream at a time.
- The DSP must specify the pool of ACD groups that is associated with the data stream.

Security

Security for the ACDMIS data stream is required for both single and multiple ACD customers. The switch must support multiple ACD customers for each data stream. You must ensure security by strictly enforcing boundaries between customer groups.

Security is handled through ACD group subpools within a pool. All ACD groups belonging to an ACD customer are grouped within a subpool. If there is only one ACD customer on a data stream, only one subpool is defined within the pool of ACD groups. If there are multiple ACD customers on a single data stream, multiple subpools are defined.

Subpools are established using the following guidelines:

- All ACD customer groups in a subpool must belong to the same pool.
- An ACD customer group can only belong to one subpool at a time.

Functional description

Table ACDMISPL establishes pools and their associated passwords and protocols.

Datafill sequence and implications

There is no requirement to datafill other tables prior to table ACDMISPL.

The following tables must be datafilled after table ACDMISPL.

- ACDMISSP
- ACDGRP

Table size

The table ACDMISPL is 0 to 60 tuples.

The data store for table ACDMISPL is allocated on a pool-by-pool basis.

ACDMISPL (continued)**Datafill**

The following table lists datafill for table ACDMISPL.

1Field descriptions

Field	Subfield or refinement	Entry	Explanation and action
POOL		alphanumeric (1 to 16 characters)	Pool name. Enter the pool name that defines a pool.
PASSWORD		alphanumeric (5 to 8 characters)	Password. Enter the password associated with the pool. Any entry outside the range indicated for this field is invalid.
PROTOCOL		BCSnn	Protocol. Enter the BCS increment in which the protocol was implemented. Protocol version BCS43 enables the ACDMIS system to use re-enqueue event messages.
OUTEVENT		10 to 200	Out event buffer size. Enter the ACDMIS out event queue size for the customer group. Note: The value in field OUTEVENT defines the size of each ACDMIS pool out event buffer. Use the following formula to calculate the total memory impact of OUTEVENT. Apply the formula to each pool and then add together all of the pool values. Value for each pool = value of field OUTEVENT × 192 Total = value for pool A + value for pool B + ... + value for pool n, where pool n is the last tuple in the table The memory impact is in bytes.
BUNDLING		Y or N	Bundling. This field specifies if the ACDMIS message bundling option has been assigned to the pool. Enter Y or N.

Datafill example

The following example shows sample datafill for table ACDMISPL.

Pool FIRST is assigned the password FREEZE and has protocol associated with BCS35. The ACDMIS out event queue size of the pool is 20. Message bundling is not assigned.

ACDMISPL (end)

Pool SECOND is assigned the password 12345 and has protocol associated with BCS 36. The ACDMIS out event queue size of the pool is 110 and message bundling is assigned to the pool.

MAP display example for table ACDMISPL

POOL	PASSWORD	PROTOCOL	OUTEVENT	BUNDLING
FIRST	FREEZE	BCS35	20	N
SECOND	12345	BCS36	110	Y

Table history

NA009

Added protocol version BCS43 for field PROTOCOL in table ACDMISPL.

NA006

Added field BUNDLING to table ACDMISPL.

Supplementary information

CSP06

The parameter ACD_MIS_OUT_EVENT_BUFFER_SIZE is now hardcoded to its maximum recommended value (200). It is no longer accessible to the user.

ACDMISSP**Table name**

Automatic Call Distribution MIS Subpool Table

Functional description

Table ACDMISSP establishes subpools and their associated pools and passwords.

For related information, refer to table ACDMISPL.

Datafill sequence and implications

Table ACDMISPL must be datafilled before table ACDMISSP.

Table size

0 to 128 tuples

Datafill

The following table lists datafill for table ACDMISSP.

Field descriptions

Field	Subfield or refinement	Entry	Explanation and action
SUBPOOL		alphanumeric (1 to 16 characters)	<i>Subpool</i> Enter the subpool name.
PASSWORD		alphanumeric (5 to 8 characters)	<i>Password</i> Enter the password associated with this subpool. Any entry outside the range indicated for this field is invalid.
POOL		alphanumeric (1 to 16 characters)	<i>Pool</i> Enter the pool name associated with this subpool.

Datafill example

An example of datafill for table ACDMISSP is shown below. In this example, SUBPOOL SUB1 is assigned the password RAIDERS, and is part of POOL FIRST.

ACDMISSP (end)

MAP display example for table ACDMISSP

SUBPOOL	PASSWORD	POOL
SUB1	RAIDERS	FIRST

ACDRTE

Table name

Automatic Call Distribution Routing Table

Functional description

Table ACDRTE defines automatic call distribution (ACD) groups.

Up to four ACD groups can be specified in table ACDRTE as overflow groups for a given ACD group, all within the same switch. In the event of an overflow condition on an incoming call queue, these groups are examined and the overflowed call is terminated on the first available group. If no groups are available, the call is rerouted to the default overflow route, as datafilled in field THROUTE in table ACDGRP.

All ACD groups must be on the same switch. When an ACD call comes into the specified ACD group and cannot be queued due to the maximum call queue size or the maximum call wait time is exceeded, the system looks at each of the designated overflow ACD groups. The call is terminated on the first available group. Termination restrictions for the overflow groups are the same as for the source group; the call may terminate on a group only if the call queue threshold has not been exceeded, the maximum call queue wait time has not been exceeded, or if the group is not in night service.

If a call terminates on one of the overflow groups, it does not overflow again. A call terminating on an overflow group is placed in the same priority queue as the source ACD group.

An entry in table ACDRTE contains the following information for each ACD group with the overflow option:

- the ACD source group
- a list of one to four ACD groups examined during overflow condition

Table ACDRTE can also contain a list of valid audio groups that can be datafilled in option AUDIO of table ACDGRP.

A list of valid routes for night service, threshold routing, and controlled interflow routing can also be stored in table ACDRTE.

An optional night service announcement can be specified using table ACDRTE. If this option is selected, a special announcement is given to the ACD caller prior to rerouting the call to the night service route.

ACDRTE (continued)

An optional forced announcement can be specified for incoming and overflow calls. If a forced announcement for incoming calls is selected, every incoming call arriving on the ACD group is forced to an announcement. If a forced announcement for overflow calls is selected, a forced announcement is provided for every call overflowed because either field MAXWAIT or MAXCQSIZ values in table ACDGRP are exceeded. If either of the forced audio options are selected, a corresponding audio group must be datafilled in table AUDIO.

If a forced announcement for Network ACD (NACD) overflow calls is selected, a forced announcement is provided for every call overflowed under the following conditions:

- the best group is not identical to the source group, and one of the following is true:
 - the QTHRESH and WTHRESH values in table NACDGRP are met or exceeded
 - the source group is in night service
 - all agents are in a make set busy (MSB) state
- the MAXWAIT or MAXCQSIZ values in table ACDGRP are exceeded and the NETOVFL option is selected in table NACDGRP
- a best group could not be determined, and the MAXWAIT and MAXCQSIZ values in table ACDGRP are exceeded

An optional route can be specified for the re-enqueue route for the ACD group. This is the route to which the re-enqueued ACD calls for that group will be routed, on expiration of the re-enqueue timer. In addition, an optional message can be specified for the re-enqueue announcement of the audio group.

Optional enhanced routing of ACD re-enqueued calls can be specified. The re-enqueue route for the ACD group can be specified. This route must be a valid route in routing tables. The audio group used for the re-enqueue announcement can be specified. The audio group specified must be datafilled in table AUDIO and assigned to the ACD feature.

For more information about ACD, see table ACDGRP.

Datafill sequence and implications

Table ACDGRP must be datafilled before table ACDRTE.

Table size

0 to 2048 tuples

ACDRTE (continued)**Datafill**

The following table lists datafill for table ACDRTE.

Field descriptions (Sheet 1 of 5)

Field	Subfield	Entry	Explanation and action
ACDGRP		alphanumeric (1 to 16 characters)	<i>Automatic call distribution group</i> Enter the name of an automatic call distribution (ACD) group that is datafilled in field ACDNAME of table ACDGRP.
OPTNAME		AUDIO CIFROUTE FIAUDIO FOAUDIO NSAUDIO OVFL RENQRTE RENQAUD TABEN or TMDTHRTE	<i>Option name</i> Enter one of the following options: <ul style="list-style-type: none"> • AUDIO - Audio • CIFROUTE - Controlled interflow • FIAUDIO - Forced announcement for incoming calls • FOAUDIO - Forced announcement for overflow calls • NSAUDIO - Night service audio group • OVFL - Overflow • RENQRTE - Re-enqueue route • RENQAUD - Re-enqueue audio • TABEN - Table entry • TMDTHRTE - Time display threshold routing

ACDRTE (continued)

Field descriptions (Sheet 2 of 5)

Field	Subfield	Entry	Explanation and action
OPTION		AUDIO CIFROUTE FIAUDIO FOAUDIO NSAUDIO OVFL RENQRTE RENQAUD TABEN or TMDTHRTE	<p><i>Option</i></p> <p>Enter an option. The options are described in field OPTNAME.</p> <p>If the entry in field OPTION is AUDIO, datafill refinement VECTOR.</p> <p>If the entry in field OPTION is CIFROUTE, datafill refinements TABNAME and INDEX.</p> <p>If the entry in field OPTION is FIAUDIO, datafill refinement FIAUDGRP.</p> <p>If the entry in field OPTION is FOAUDIO, datafill refinement FOAUDGRP.</p> <p>If the entry in field OPTION is NSAUDIO, datafill refinement NSAUDGRP.</p> <p>If the entry in field OPTION is OVFL, datafill refinement OVFLLIST.</p> <p>If the entry in field OPTION is RENQRTE, datafill refinement ROUTE.</p> <p>If the entry in field OPTION is RENQAUD, datafill refinement RENQAUDGRP.</p> <p>If the entry in field OPTION is TABEN, datafill refinements RTETABLE and INDEX.</p> <p>If the entry in field OPTION is TMDTHRTE, datafill refinements TABNAME, INDEX, and TIME.</p>
	VECTOR	alphanumeric (vector of up to 8 names)	<p><i>Audio entry vector</i></p> <p>If the entry in field OPTION is AUDIO, datafill this refinement. Enter up to eight audio group names.</p>
	TABNAME	IBNRTE IBNRT2 IBNRT3 IBNRT4 IRTE, OFRT, OFR2, or OFR4	<p><i>Table name</i></p> <p>If the entry in field OPTION is CIFROUTE, datafill this refinement. Enter the name of the table to which translation routes.</p> <p>If the entry in this field is any entry other than IRTE, datafill refinement INDEX; otherwise, datafill refinements XLASYS, XLANAME, and RTEREF.</p>

ACDRTE (continued)

Field descriptions (Sheet 3 of 5)

Field	Subfield	Entry	Explanation and action
	INDEX	1 to 1023	<p><i>Index</i></p> <p>If the entry in field OPTION is CIFROUTE, and the entry in field TABNAME is any entry other than IRTE, datafill this refinement. Enter the number assigned to the route list in the table to which translation routes.</p> <p>Note: Zero (0) is not a valid entry for this field.</p>
	XLASYS	AC, AM, CT, FA, FT, NIL, NSC, OFC, or PX	<p><i>Translations system</i></p> <p>If the entry in field TABNAME is IRTE, datafill this refinement. Specify the translation system and datafill refinement XLANAME.</p>
	XLANAME	NIL	<p><i>Translations name</i></p> <p>If the entry in field TABNAME is IRTE, datafill this refinement, then datafill refinement RTEREF. Enter the translations name.</p>
	RTEREF	0 to 1023	<p><i>Route reference</i></p> <p>If the entry in field TABNAME is IRTE, datafill this refinement. Enter a numeric value to specify the route.</p>
	NSAUDGRP	AUDIO1 to AUDIO512	<p><i>Night service audio group</i></p> <p>If the entry in field OPTION is NSAUDIO, datafill this refinement. Enter the night service audio group name.</p>
	FIAUDGRP	AUDIO1 to AUDIO512	<p><i>Forced announcement for incoming calls</i></p> <p>If the entry in field OPTION is FIAUDIO, datafill this refinement. Enter the forced announcement audio group name.</p>
	FOAUDGRP	AUDIO1 to AUDIO512	<p><i>Forced announcement for overflow calls</i></p> <p>If the entry in field OPTION is FOAUDIO, datafill this refinement. Enter the forced announcement audio group name.</p>

ACDRTE (continued)

Field descriptions (Sheet 4 of 5)

Field	Subfield	Entry	Explanation and action
	OVFLLIST	alphanumeric (1 to 16 characters)	<i>Overflow list</i> If the entry in field OPTION is OVFL, datafill this refinement. Enter the name of the destination ACD group(s) to which calls are overflowed. Up to 4 groups can be specified.
	RENQAUDGRP	AUDIO1 to AUDIO511	<i>Re-enqueue audio group</i> If the entry in field OPTION is RENQAUD, datafill this refinement. Enter the audio group used for the re-enqueue announcement. Datafill the specified audio group in table AUDIO and assign it to the ACD feature.
	ROUTE	TABNAME: {OFRT, OFR2,OFR3, OFR4, IBNRTE, IBNRT2, IBNRT3, IBNRT4 }INDEX: {0 to 1023}	<i>Route</i> If the entry in field OPTION is RENQRTE, datafill this refinement. Enter the route to which the re-enqueued ACD calls for that group will be routed, on expiration of the re-enqueue timer. This route must be a valid route in routing tables.
	RTETABLE	IBNRTE IBNRT2 IBNRT3 IBNRT4 IRTE, OFRT, OFR2, or OFR4	<i>Route table</i> If the entry in field OPTION is TABEN, datafill this refinement. Enter the table to which translation routes. Up to ten routes can be entered.
	INDEX	1 to 1023	<i>Index</i> If the entry in field OPTION is TABEN, datafill this refinement. Enter the number assigned to the route list in the table to which translation routes. Note: Zero (0) is not a valid entry for this field.

ACDRTE (continued)

Field descriptions (Sheet 5 of 5)

Field	Subfield	Entry	Explanation and action
	TABNAME	IBNRTE IBNRT2 IBNRT3 IBNRT4 IRTE, OFRT, OFR2, or OFR4	<i>Table name</i> If the entry in field OPTION is TMDTHRTE, datafill this refinement. Enter the name of the table to which translation routes. If the entry in this field is any entry other than IRTE, datafill refinement INDEX; otherwise, datafill refinements XLASYS, XLANAME, and RTEREF.
	INDEX	1 to 1023	<i>Index</i> If the entry in field OPTION is TMDTHRTE, datafill this refinement. Enter the number assigned to the route list in the table to which translation routes. Note: Zero (0) is not a valid entry for this field.
	XLASYS	AC, AM, CT, FA, FT, NIL, NSC, OFC, or PX	<i>Translations system</i> If the entry in field TABNAME is IRTE, datafill this refinement. Specify the translation system and datafill refinement XLANAME.
	XLANAME	NIL	<i>Translations name</i> If the entry in field TABNAME is IRTE, datafill this refinement, then datafill refinement RTEREF. Enter the translations name.
	RTEREF	0 to 1023	<i>Route reference</i> If the entry in field TABNAME is IRTE, datafill this refinement. Enter a numeric value to specify the route.
	TIME	0 to 1800	<i>Time</i> If the entry in field OPTION is TMDTHRTE, datafill this refinement. Enter the amount of time a call is enqueued at the original ACD group or overflow ACD group before being transferred to the specified route.

ACDRTE (end)**Datafill example**

The following example shows sample datafill for table ACDRTE.

MAP display example for table ACDRTE

ACDGRP	OPTNAME		OPTION	
OPTION				
	GARB	GOC	0	OFR2 2
	OFR3 6	9 Y	56	87
		Y 600 500 300	CALLQ N	N N NONE N
N			(AUDIO 7 N	AUDIO1) \$

Table history**NA011**

Added text for forced announcements with NACD calls.

NA009

Added new option RENQRTE with subfield ROUTE and option RENQAUD with subfield RENQAUDGRP to table ACDRTE.

BCS37

A note was added to field RTETABLE regarding route manipulation

BCS36

The range of values for both TABNAME fields and field RTETABLE was clarified. Fields XLASYS, XLANAME, and RTEREF were added to maintain consistency with an IRTE entry in either field TABNAME.

ACDSGRP

Table name

Automatic Call Distribution Subgroup Table

Functional description

Each Automatic Call Distribution (ACD) group can be subdivided into subgroups.

Each ACD group can be assigned a maximum of 255 subgroups. A subgroup of zero is datafilled in applications for which the subgroup facility is not desired.

For each subgroup defined in this table, the following is required:

- If necessary, provide the equipment location, common language location identifier (CLLI), or line equipment number (LEN) of the recording equipment that is engaged when an agent has signaled an emergency situation (the ACD Emergency feature is not yet available).
- The customer must provide appropriate equipment and attach it to the circuit specified. The equipment can be interfaced either as a trunk circuit or as a line circuit.
- If recording equipment is interfaced with a line card, it must be a standard line, for example, a 2X17, 2X18, 6X17, or 6X18 line card.
- If the customer-supplied recording equipment continuously sends an offhook signal to the switching unit, then the line must be assigned the cutoff on disconnect (COD) and fire reporting system (FRS) line options, so that a signal distribution (SD) point can be wired in series with the line. This prevents the line circuit from going into lockout.

Hunting is not supported. If the specified LEN is a member of a hunt group, no hunting occurs.

If customer has MIS, a supervisor with a valid supervisor identity must be assigned to each subgroup so that the subgroup information in the DMS remains accurate when using the MIS management of agents to supervisor.

For related information, refer to table ACDGRP.

ACDSGRP (continued)**Datafill sequence and implications**

The following tables must be datafilled before table ACDSGRP:

- ACDGRP

The following tables must be datafilled after table ACDSGRP:

- KSETLINE

Table size

If an ACD group is assigned one or more subgroups, memory is allocated for 255 subgroups for that ACD group.

Datafill

The following table lists datafill for table ACDSGRP.

Field descriptions (Sheet 1 of 2)

Field	Subfield or refinement	Entry	Explanation and action
ACDGROUP		alphanumeric (up to 16 characters)	<i>Automatic call distribution group name</i> Enter the name assigned to the ACD group.
SUBGROUP		1 to 255	<i>Automatic call distribution subgroup number</i> Enter the number assigned to the subgroup.
RECORDER		see subfield	<i>Recorder</i> This field consists of subfield CHOICE.
CHOICE		NONE TRUNK or LINE	<i>Choice</i> Enter NONE if no recording equipment is provided. No other datafill is required. Enter TRUNK and datafill refinement CLLI if the recording equipment is interfaced as a trunk circuit. Enter LINE and datafill refinements LEN and TWOWAY if the recording equipment is interfaced as a line circuit.
CLLI		alphanumeric (up to 16 characters)	<i>Common language location identifier</i> Enter the common language location identifier (CLLI) code of the trunk group to which the recording equipment is connected.

ACDSGRP (continued)**Field descriptions (Sheet 2 of 2)**

Field	Subfield or refinement	Entry	Explanation and action
LEN		see subfields	<p><i>Line equipment number</i> This field defines the physical location of the equipment that is connected to a specific telephone line.</p> <p>Because field LEN is common to more than 60 tables, it is documented in a single section to avoid unnecessary duplication. Refer to section "Common entry field LEN" for a complete description of field LEN and associated subfields.</p> <p>Field LEN consists of subfields SITE, FRAME, UNIT, DRAWER or LSG, SHELF, SLOT, and CIRCUIT.</p>
TWOWAY		Y or N	<p><i>Twoway connection</i> Enter Y if the connection to the auxiliary device is twoway. Enter N if the connection to the auxiliary device is oneway.</p>

Datafill example

The following example shows sample datafill for table ACDSGRP.

ACDSGRP (end)**MAP display example for table ACDSGRP**

ACDGROUP	SUBGROUP	RECORDER
AUTOMATED_WORLD	1	NONE
SUSHI_FLIGHT_INF	1	NONE
SUSHI_TRAIN_INF	1	NONE
SUSHI_CAR_INF	1	NONE
SUSHI_BUS_INF	1	NONE
JAL_FLIGHT_INF	1	NONE
JAL_TRAIN_INF	1	NONE
YEN_FLIGHT_INF	1	NONE
YEN_TRAIN_INF	1	NONE
YEN_CAR_INF	1	NONE
SUSHI_TAKE_OUT	1	NONE
JAL_RESERVATION	1	NONE
JAL_INFORMATION	1	NONE
BANK_OF_KYOTO	1	NONE
ACD5704	1	NONE
ACD5705	1	NONE
ACD5706	1	NONE
ACD5707	1	NONE
ACD5708	1	NONE
ACD5709	1	NONE

ACDTKMEM**Table name**

Automatic Call Distribution Trunk Member Table

Functional description

Table ACDTKMEM associates the switch computer application interface (SCAI) links with trunk member, Automatic Call Distribution (ACD) group, directory number (DN), and position identification (ID) to provide SCAI ACD trunk agents.

Datafill sequence and implications

The following tables must be datafilled before table ACDTKMEM:

- CLLI
- TRKGRP
- TRKSGRP
- TRKMEM (for ACD trunk members)
- ACDGRP
- ACDSGRP
- SCAILNKS

Table size

0 to 8191 tuples

The size of table ACDTKMEM is controlled through the entry for table TRKGRP in table DATASIZE.

Datafill

The following table lists datafill for table ACDTKMEM.

Field descriptions (Sheet 1 of 4)

Field	Subfield or refinement	Entry	Explanation and action
ACDTKMEM		see subfields	<i>ACD trunk members</i> This field consists of subfields CLLI and MEMNAME.
	CLLI	alphanumeric (up to 16 characters)	<i>Common language location identifier</i> Enter the common language location identifier (CLLI) defined in table CLLI.

ACDTKMEM (continued)

Field descriptions (Sheet 2 of 4)

Field	Subfield or refinement	Entry	Explanation and action
	MEMNAME	0 to 9999	<i>Trunk member</i> Enter the trunk member number defined in table TRKMEM.
ACDGRP		alphanumeric (up to 16 characters)	<i>ACD group name</i> Enter the ACD group defined in table ACDGRP.
ACDSGRP		0 to 255	<i>ACD subgroup</i> Enter the ACD subgroup defined in table ACDGRP. A value of 0 (zero) indicates that a subgroup is not assigned.
IDNUM		Y or N	<i>Identification number</i> Enter Y (yes) if an agent position identification (ID) is required and datafill refinement POSID. Otherwise, enter N (no).
	POSID	0000 to 9999	<i>Position identification</i> If the entry in field IDNUM is Y, datafill this refinement. Enter the agent position ID.
ACDTKDN		see subfields	<i>ACD trunk directory number</i> This field consists of subfields SNPA, NXX, and DEFDIGS.
	SNPA	200 to 999	<i>Terminating serving numbering plan area</i> Enter the serving numbering plan area (SNPA) of the called terminating line DN.
	NXX	200 to 999	<i>Terminating office code NXX</i> Enter the office code of the called terminating line DN, where N is a range from 2 to 9 and X is a range from 0 to 9.
	DEFDIGS	0000 to 9999	<i>Defining digits</i> Enter the range of the defining digits.

ACDTKMEM (continued)

Field descriptions (Sheet 3 of 4)

Field	Subfield or refinement	Entry	Explanation and action
OPTION		OBS, SCAI, SUPR, or WARNTONE	<p><i>Options</i> Enter the options required.</p> <p>Enter OBS for the observe agent option and datafill refinement EXTDOBS.</p> <p>Enter SCAI for the switch to computer application interface and datafill refinement SCAILINK.</p> <p>Enter SUPR for the supervisor option and datafill refinements ACDGRP, ACDSGRP, and IDNUM.</p> <p>Enter WARNTONE for a warning tone. No further datafill is required.</p>
CONTMARK		+ or \$	<p><i>Continuation mark</i> Enter + if information for this tuple is contained in the next line. Otherwise, enter \$ to indicate the end of the tuple.</p>
	EXTDOBS	Y or N	<p><i>Extended observe agent</i> If the entry in field OPTION is OBS, datafill this refinement. Enter Y if the supervisor has extended observe agent capabilities. Otherwise, enter N and datafill refinement ACDGRP.</p>
	ACDGRP	alphanumeric (up to 16 characters)	<p><i>ACD group</i> If the entry in refinement EXTDOBS is N and the entry in field OPTION is OBS, datafill this refinement. Enter the ACD group the supervisor can observe. No further datafill is required.</p>
	SCAILINK	alphanumeric (up to 8 characters)	<p><i>SCAI link name</i> If the entry in field OPTION is SCAI, datafill this refinement. Enter the SCAI link name as defined in table SCAILNKS. No further datafill is required.</p>
	ACDGRP	alphanumeric (up to 16 characters)	<p><i>ACD group name</i> If the entry in field OPTION is SUPR, datafill this refinement. Enter the ACD group to which the supervisor is assigned.</p>

ACDTKMEM (end)

Field descriptions (Sheet 4 of 4)

Field	Subfield or refinement	Entry	Explanation and action
	ACDSGRP	1 to 255	<i>ACD subgroup</i> If the entry in field OPTION is SUPR, datafill this refinement. Enter the ACD subgroup to which the supervisor is assigned.
	IDNUM	Y or N	<i>Identification number</i> If the entry in field OPTION is SUPR, datafill this refinement. Enter Y if the position ID of the supervisor is required. Otherwise, enter N.
	POSID	0000 to 9999	<i>Position ID</i> If the entry in refinement IDNUM is Y and the entry in field OPTION is SUPR, datafill this refinement. Enter the position ID of the ACD supervisor. No further datafill is required.

Datafill example

The following example shows sample datafill for table ACDTKMEM.

MAP display example for table ACDTKMEM

ACDTKMEM	ACDGRP	ACDSGRP	IDNUM	ACDTKDN	OPTIONS
ACDFXSLS	1	ACDGRP1	1	Y 1234	2141234567
				SCAI	LINKSET1
				SUPR	ACDGRP1 1 Y 2345
			OBS N	ACDGRP1	

ACHEAD**Table name**

Access Code Head Table

Overview

The table below lists all the universal translation tables. Throughout this document, “xxHEAD” represents one of the HEAD tables.

Universal translation tables (Sheet 1 of 2)

Table name	Form title	Table type
ACHEAD	Access Code	Head Table Record
AMHEAD	Ambiguous Code	Head Table Record
CTHEAD	Country Code	Head Table Record
FAHEAD	Foreign Area Code	Head Table Record
FTHEAD	Utility Code	Head Table Record
NSCHEAD	Number Service Code	Head Table Record
OFCHEAD	Office Code	Head Table Record
PXHEAD	Prefix Code	Head Table Record
ACCODE	Access Code	Code Table Record
AMCODE	Ambiguous Code	Code Table Record
CTCODE	Country Code	Code Table Record
FACODE	Foreign Area Code	Code Table Record
FTCODE	Utility Code	Code Table Record
NSCCODE	Number Service Code	Code Table Record
OFCCODE	Office Code	Code Table Record
PXCODE	Prefix Code	Code Table Record
ACRTE	Access Code	Route Table Record
CTRTE	Country Code	Route Table Record
FARTE	Foreign Area Code	Route Table Record
Note: There is no AMRTE table.		

ACHEAD (continued)**Universal translation tables (Sheet 2 of 2)**

Table name	Form title	Table type
FTRTE	Utility Code	Route Table Record
NSCRTE	Number Service Code	Route Table Record
OFCRTE	Office Code	Route Table Record
PXRTE	Prefix Code	Route Table Record
Note: There is no AMRTE table.		

Tables TOFCNAME and DNINV are also used for translating some segments of the incoming digit string and form an integral part of the universal digit translations scheme.

In international loads, the tables listed in table 1 and tables TOFCNAME, DNINV, and DNRTE replace the following tables:

- STDPRTCT
- HNPACONT
- FNPACONT
- CLSVSCRC
- LCASCRCN
- PFXTREAT
- THOUGRP
- WRDN
- DN

Table OFRT can be used in international loads for treatments and standard routes.

Universal translation tables functional overview

The DMS-100 switch uses the universal translation tables to translate the digit string after receiving the digits from the originator using the digit analysis tables DCHEAD and DCCODE.

The translation of incoming digits begins in the universal translation tables. The entry point into the translation tables is defined as XLASYS, the translation system, and XLANAME, the translation name. If a call originates in an international office, fields XLASYS and XLANAME of table

ACHEAD (continued)

LINEATTR (at the line attribute index applicable to the originating line) determine the point where translation of the received dialed digits begins. An originating incoming call on a trunk or group type, such as MTR or TPS101, is translated in the universal translation tables using fields XLASYS and XLANAME of table TRKGRP, if field XLASEL is set to UNIV in table TRKGRP or in table NETATTR. If field XLASEL is set to NETATTR in table TRKGRP using the table NETATTR tuple index specified in table TRKGRP, this index, field NETINDX, determines the point where translation of the received digits begins.

The results of the digit translation in the universal translation tables are shown below.

- The call is routed to one of the following places:
 - a terminating subscriber line
 - an outgoing trunk group
 - another network
- The call fails to route and the applicable treatment code is determined. This results in the prescribed combination of announcements or tones, or both, being returned to the originator.
- Translation recognizes that the digits dialed are a specific function code of a specific feature and reacts accordingly.
- Modification or replacement of the received digit string occurs before outpulsing and call data recording.
- The parameters required for screening and charging are determined.

Universal translations flow diagram

An illustration of universal translations is shown in the following figure.

ACHEAD (continued)

Universal translations flow diagram

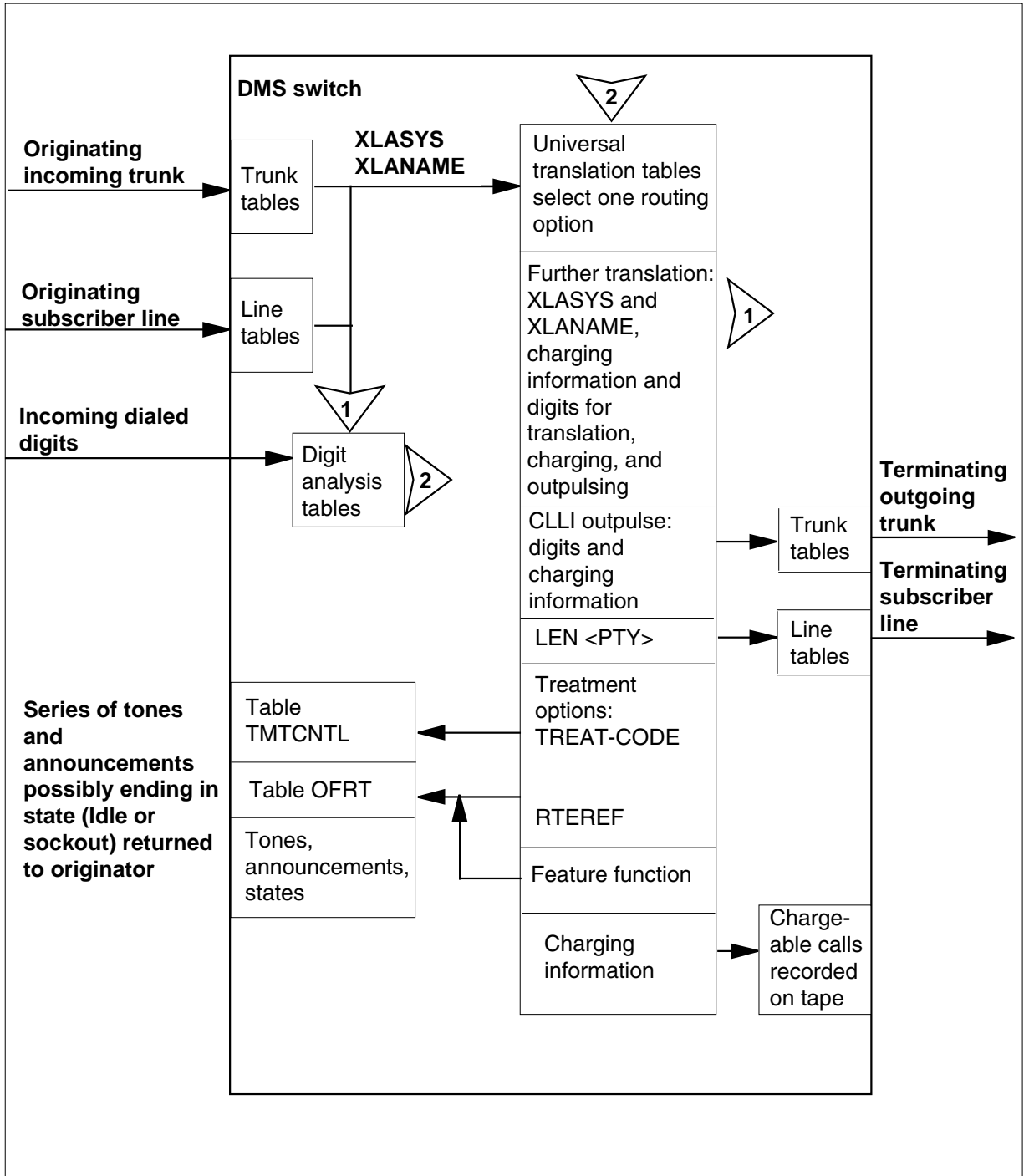

ACHEAD (continued)

Universal translation tables routing block diagram

A block diagram of the universal translation tables is shown in the following figure.

Universal translation tables routing block diagram

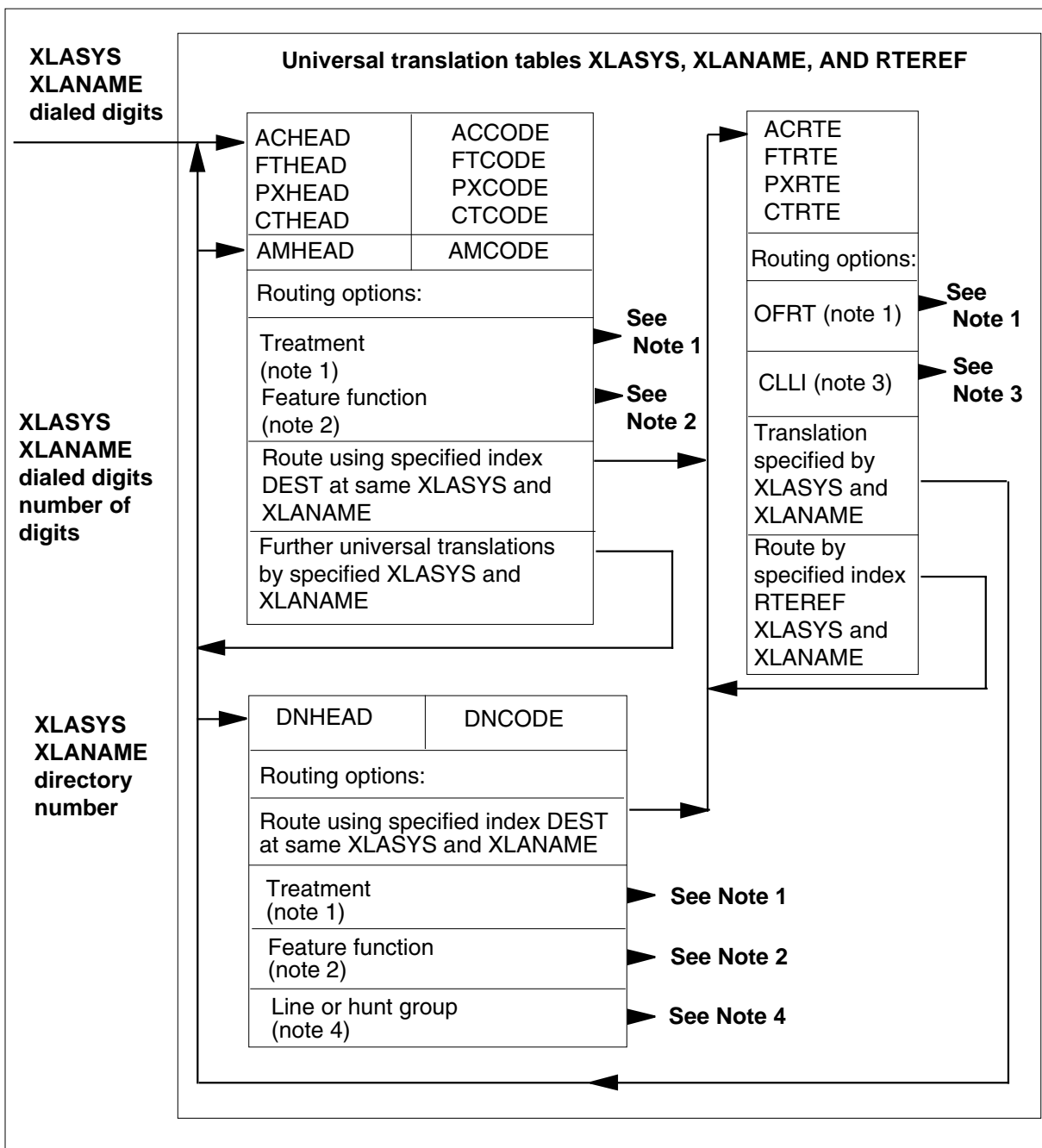

ACHEAD (continued)

Universal translation tables routing block diagram (continued)

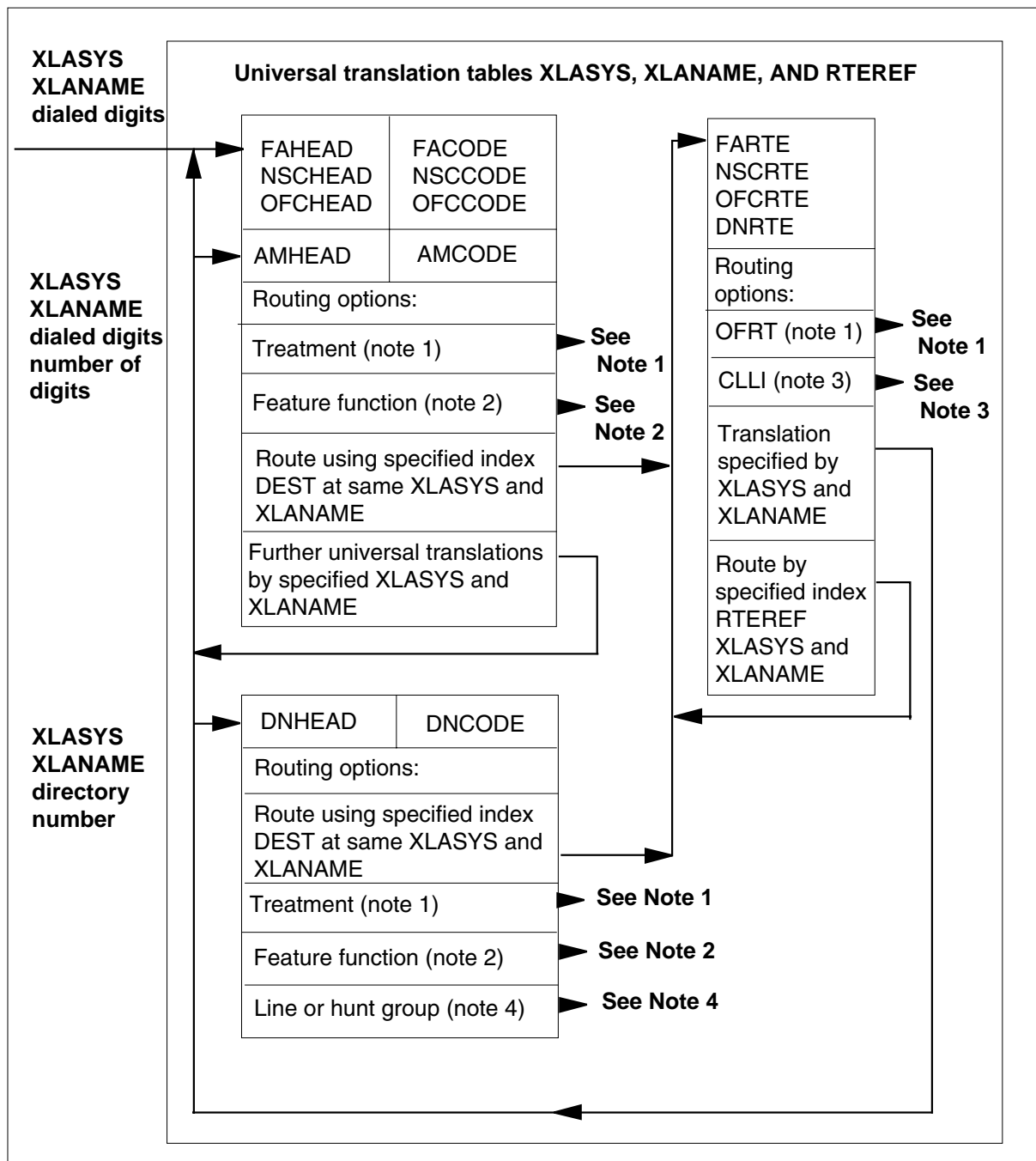

ACHEAD (continued)

Routing block diagram notes

Note 1: Translation results in one of the following indexes being returned to the originator of the call:

- a treatment code index into table TMTCNTL.TREAT leading to a tone, announcement, and state common language location identifier (CLLI)
- a route reference index into table OFRT for a series of tones, announcements, and state CLLIs

Note 2: The dialed digits are recognized as a function of a specific feature. DMS software then performs all associated functions related to the feature.

Note 3: The call is routed to an outgoing trunk group CLLI through trunk tables. Digits, or charging information, or both, can be outpulsed. Two-stage outpulsing can be specified.

Note 4: The call is routed to a line or hunt group through line or hunt group tables.

Translations flowchart for tables xxHEAD and xxCODE

An illustration of translations in tables xxHEAD and xxCODE with field XLASYS set to AC, AM, CT, FA, FT, NSC, OFC, and PX is shown in the following figure.

ACHEAD (continued)

Translations in tables xxHEAD and xxCODE

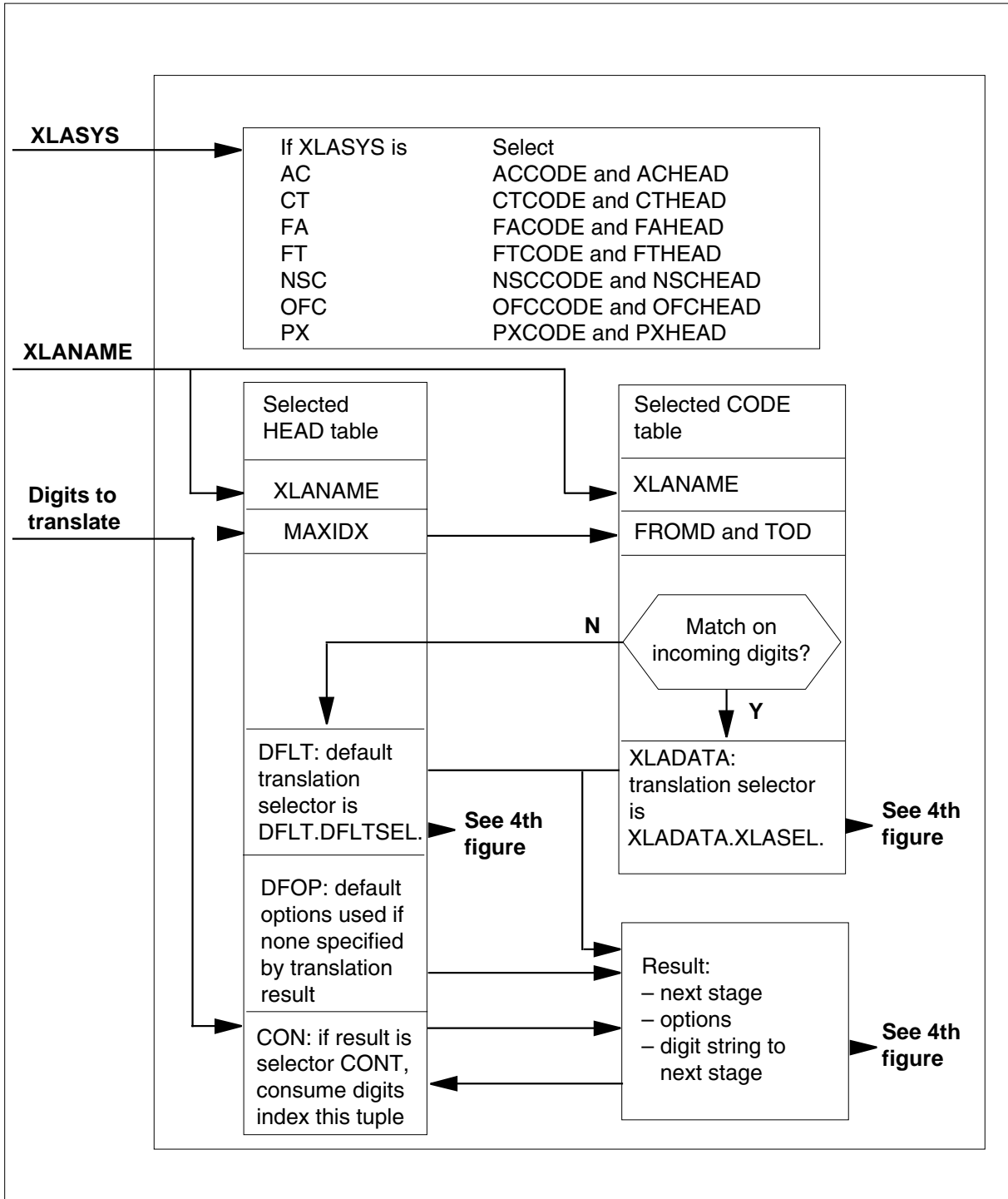

ACHEAD (continued)

Digit or default translations

An illustration of digit or default translations is shown in the following figure.

Digit or default translations

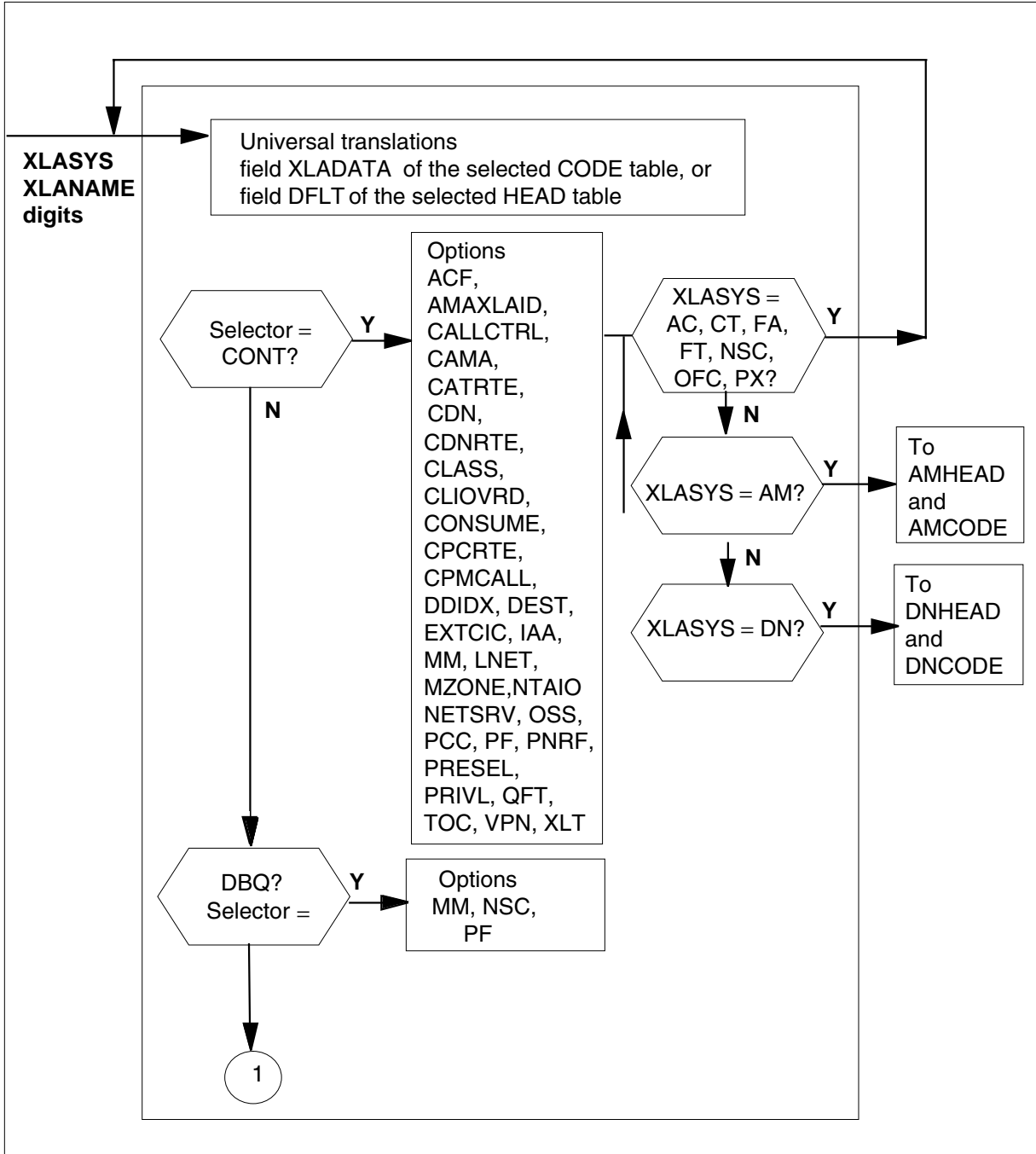

ACHEAD (continued)

Digit or default translations (cont'd)

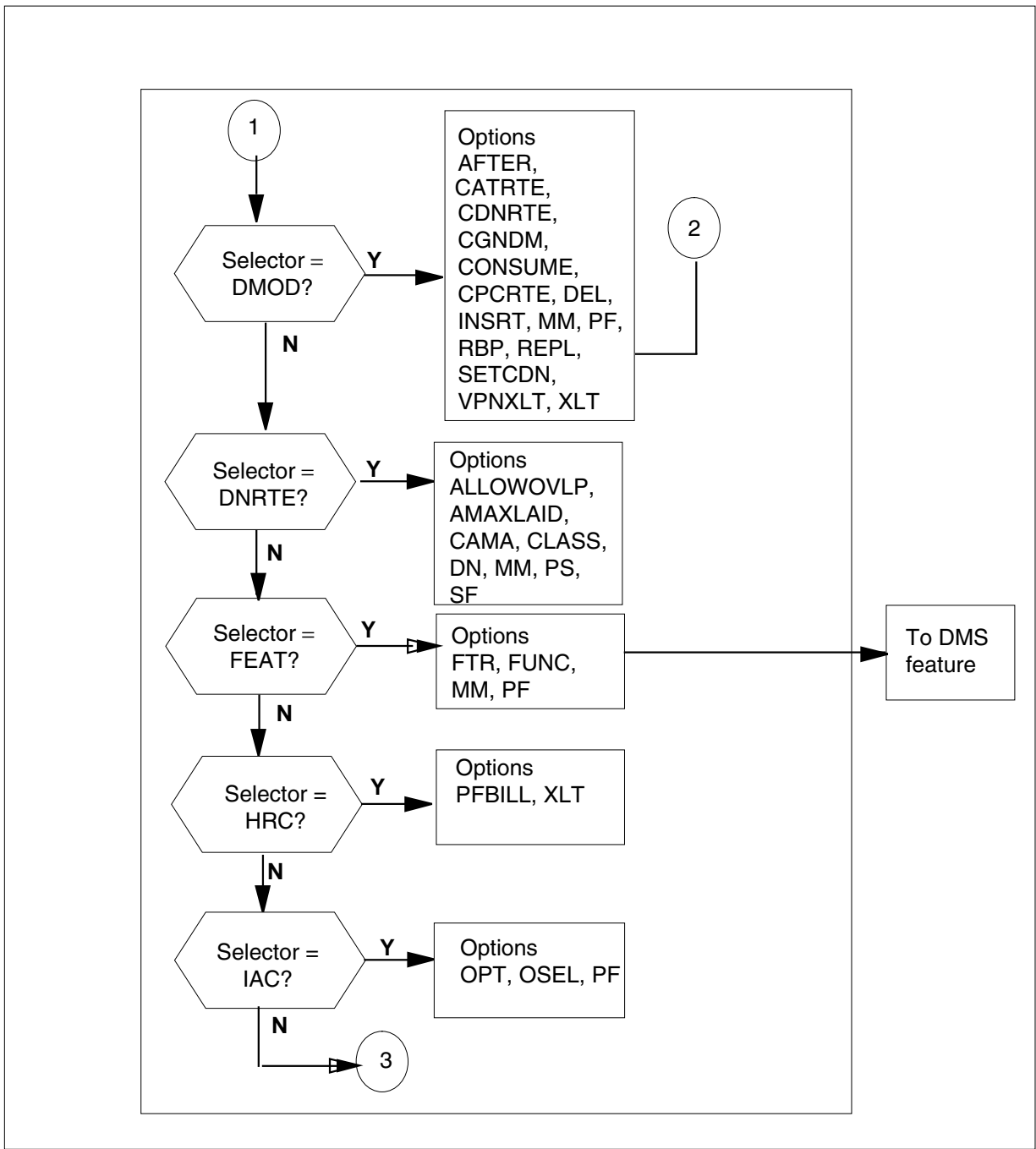

ACHEAD (continued)

Digit or default translations (cont'd)

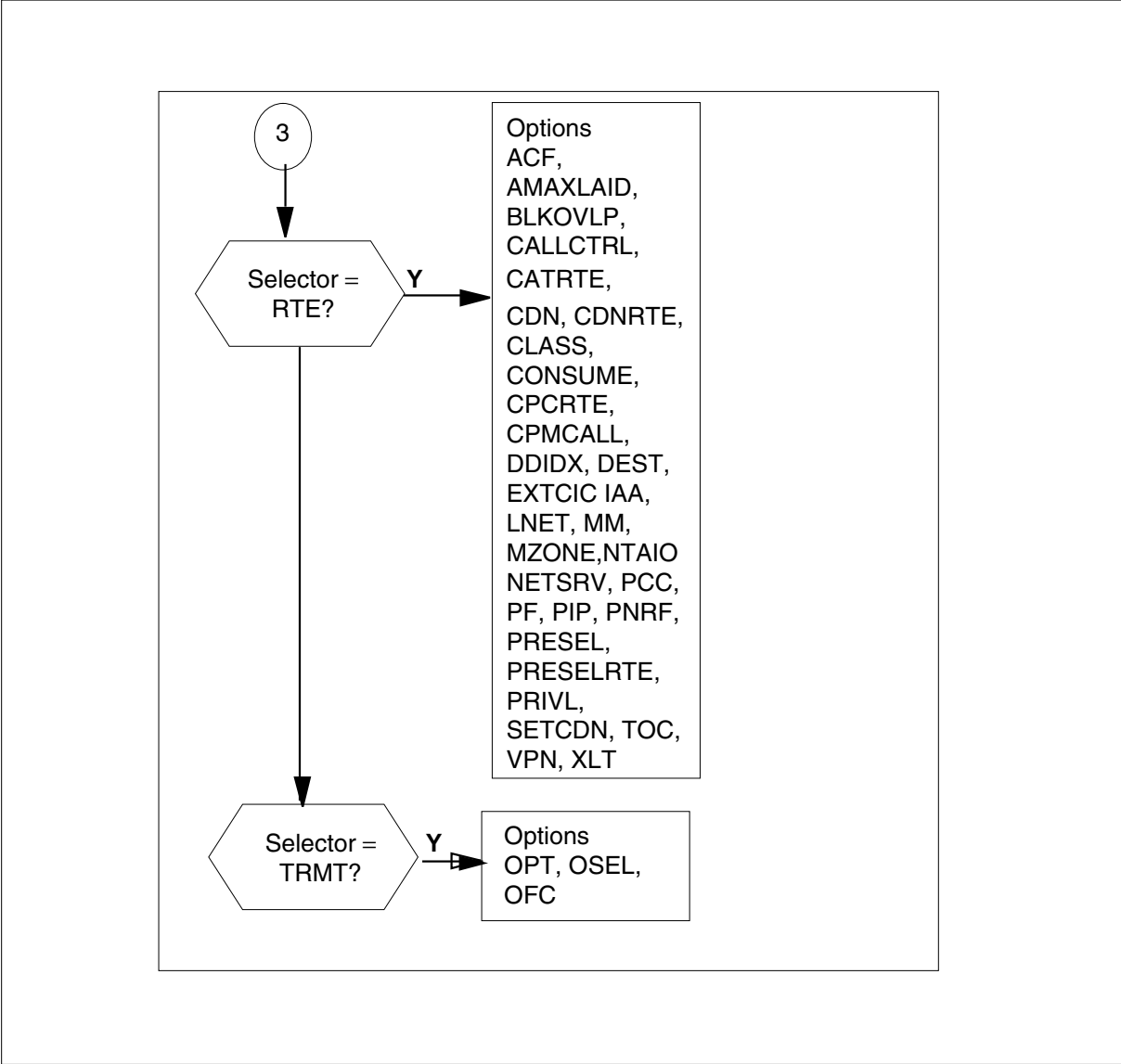

Universal translations options table

Before attempting to datafill translation tables, the following information must be available:

- office trunking diagram
- office dialing plan

A translation path must be provided for each possible dialed digit string by each of the potential originators (lines and trunks).

ACHEAD (continued)

In addition to routing the call to the desired destination, the following information must also be available:

- treatment
- feature function
- line or hunt group
- outgoing trunk group CLLI

The universal translation tables are used to define or modify

- the digits and charging parameters to outpulse, if any
- the calls that are chargeable and the value of the charge parameters

The incoming digit string is translated in the universal translation tables in functional digit segments. The translation of a digit segment can lead the translation path back into the universal translation tables for the translation of the next digit segment.

Each pass through the universal translation tables can modify some of the charging parameters and the digit strings used for outpulsing, charging, and translation. It is sometimes necessary to send the call for more translation in the universal translation tables to set the charging parameters to the required values and modify the various digit strings.

Translation of a digit segment involves the selection of a specific translation selector. Each translation selector groups a different set of charging parameters and digit string modifiers.

ACHEAD (continued)**Universal translations options**

The following table lists the options available for the universal translations tables xxHEAD and xxCODE. These tables do not have conditional options.

Universal translations options for xxHEAD and xxCODE tables (Sheet 1 of 2)

Functions and selectors		Digit string manipulation	Screening and charging	Proceed from: Proceed to:
CON		CON		
CONT	MM	CONSUME	ACF, AMAXLAID, CALLCTRL, CAMA, CATRTE, CLASS, IAA, LNET, MZONE, NETSRV, NTAIO, PF, PRESEL, QFT, VPNPAN	DEST to route table XLT to new translation system
DBQ	MM		NSC, PF	
DMOD		AFTER, CONSUME, DEL, INSRT, PF, REPL, VPNREPL, VPNXLT	CATRTE	XLT to new translation system
DNRTE	MM	PF, SF	AMAXLAID, CAMA, CLASS	DN to table TOFCNAME
FEAT				VSC to vertical service code tables
FEATINFO			CALLCHAR	VSC to vertical service code tables
HRC			PFBILL	XLT to new translation system
IAC			PF	
MAXIDX (field)	STD, 0-9, B, F			

ACHEAD (continued)

Universal translations options for xxHEAD and xxCODE tables (Sheet 2 of 2)

Functions and selectors	Digit string manipulation	Screening and charging	Proceed from: Proceed to:
RTE	MM	ACF, AMAXLAID, BLKOVLP, CALLCTRL, CAMA, CATRTE, CLASS, IAA, LNET, MZONE, NETSRV, NTAIO, PF, PRESEL, QFT, or VPNPAN	DEST to route table
TRMT			OFC to treatment

The following table lists the options available for the universal translations tables xxRTE. These tables do not have digit string checking or screening and charging functions.

Universal translations options for xxRTE tables

Functions and selectors	Digit string manipulation	Proceed from: Proceed to:	Conditional
CND			CNDSEL=TOD, NRR, or RNDRTETYPE=ST, SK, or T
N	DELETE, PFXDIGS, or PFXAFTER	CLLI to trunk group	
NOT			CNDSEL=NRR RTETYPE=ST, SK, or T
RT	RT_DIGITS	RX_LA_TAB to new translation system	
S		CLLI to trunk group	
T		EXTRTEID to new table	

ACHEAD (continued)**Universal translation tables internal overview**

The universal translation tables are organized to translate the incoming digit string in segments according to the order shown in the following table.

Digit string segment descriptions

Digit string segment descriptions	XLASYS	Tables
Access code digits	AC	ACHEAD, ACCODE
Utility code digits	FT	FTHEAD, FTCODE
Prefix code digits	PX	PXHEAD, PXCODE
Country code digits	CT	CTHEAD, CTCODE
Foreign area code digits	FA	FAHEAD, FACODE
Office code digits	OFC	OFCHEAD, OFCCODE
Number service code digits	NSC	NSCHEAD, NSCCODE
Ambiguous code	AM	AMHEAD, AMCODE

Note: The XLASYS translation stages described in this section (AC, AM, CT, FA, FT, NSC, OFC, PX) are identical in format and function. The mnemonic names and descriptive titles of each of the XLASYS translation stages in this section are only a guideline for the translation of a typical digit string. The software treats each of the XLASYS translation stages identically.

Universal translation stages for ambiguous codes (tables AMHEAD and AMCODE) and directory number (tables TOFCNAME and DNINV) are also used for translating some segments of the incoming digit string and form an integral part of the universal digit translations scheme.

A generalization of all numbering plans is shown below.

```

access code
+utility code
  +prefix code
    +country code
      +foreign area code
        +office code
          +number service code
            +station number

```

ACHEAD (continued)

Access code (XLASYS AC)

The access code is for access to another network, an attendant, or a feature. If a feature access code is dialed, the digits following do not correspond to the numbering plan. The access code of a network is usually required only when dialing into another network. For example, the user must dial an access code of 9 to access the local operating telephone company network from a private tie line network.

Utility Code (XLASYS FT)

The utility code is called from office parameters and is used to perform operations such as validation of an announcement or a call diversion destination.

Prefix code (XLASYS PX)

The prefix code gives information about the local operating telephone company type of call being dialed. For example, in North America there usually are prefix codes for domestic direct distance dialing (DDD), international DDD, domestic operator-handled calls, and international operator-handled calls. The default is usually not to dial the prefix code for a local call.

Country code (XLASYS CT)

Country codes are internationally agreed upon one-, two-, or three-digit numbers, beginning with the zone digit. Each country also has a pseudo country code, which is used for operator-handled traffic. All country codes are uniquely defined. The country code can be omitted if dialing a destination inside the same country (and sometimes if the destination is in an adjacent country).

Foreign area code (XLASYS FA)

An area code is assigned to an area of the country. In North America, area codes are distinguishable from office codes so that if the called number is within the same area as the calling number, the area code is not dialed. If it is dialed, it is ignored or blocked.

Office code (XLASYS OFC)

An office code is an exchange within the area.

Number service code (XLASYS NSC)

A number service code is for service switching point (SSP) applications that require access to a database.

ACHEAD (continued)**Ambiguous code (XLASYS AM)**

The ambiguous code universal translations tables are invoked when the total number of digits received in addition to the leading digits received determine which terminating route applies.

Universal translation of a digit segment

To translate each of the digit string segments, there are three universal translations tables:

- (XLASYS)HEAD table
- (XLASYS)CODE table
- (XLASYS)RTE table

For example, the universal translations tables used to translate the prefix code digits segment, translation system XLASYS PX, are PXHEAD, PXC CODE, and PXRTE.

In the universal translation tables described in this section

- each (XLASYS)HEAD table has identical syntax with other (XLASYS)HEAD tables
- each (XLASYS)CODE table has identical syntax with other (XLASYS)CODE tables
- each (XLASYS)RTE table has identical syntax with other (XLASYS)RTE tables

Universal translation tables digit string checking options

The initial time-out and interdigit time-out are defined in table DGHEAD and table DGCODE.

The following table shows the digit string presented for translation at each stage of universal translations described in this section.

Digit string checking options (Sheet 1 of 2)

Field	Refinements, values, and explanations
Option MM of selectors CONT, RTE, and DNRTE	<p>MIN (0 to 30) MAX (0 to 30) Minimum and maximum total number of digits expected</p> <p>Typical input: MM 7 10</p> <p>The call terminates in a treatment if the total number of digits received is less than the minimum number specified in this option.</p> <p>Digits received, after the specified maximum number of digits is received, are ignored.</p>

ACHEAD (continued)**Digit string checking options (Sheet 2 of 2)**

Field	Refinements, values, and explanations	
Field MAXIDX	STD (0-9), B, or F (default: 9) B Maximum index	Typical input: MAXIDX
	The translation tables are indexed by dialed digits. The default case is that these digits fall in the range of 0 to 9. Certain code tables can be required to include hex B (*), hex C (#) or the range 0 to 9 and hex digits B, C, D, E, and F in their indexes. For example, feature access codes can have format *XX, where * is hex B. (B is specified in field MAXIDX in the HEAD table.)	

Universal translation tables digit string manipulation options

The digit string presented for translation at each stage of universal translations determines what digit string, if any, is presented to the next stage of translation or routing. The digit string presented for translation at any stage is the result of digit manipulations in the preceding stages.

In addition to being used for translation of the call, the received digits determine what digit string, if any, is recorded for charging purposes and what digit string, if any, is outpulsed.

Each of the digit manipulation options in various translation tables can affect all or some of the three-digit strings (digit string for translation in the next stage, the call detail record digit string, and the outpulsed digit string).

The universal translation tables digit manipulation options, listed and described in the following table, can occur in one or more tables as detailed on the following pages.

Digit string manipulation options (Sheet 1 of 3)

Option	Refinements, values, and explanations	
PF	PFDIGS (0 to 24) Number of prefix digits	Typical input: PF 1
	This is the number of prefix digits in the digit strings presented to this stage for translation, call detail recording, and outpulsing. Prefix digits are not used to index any further translation tables and are not outpulsed, but they do remain stored in call detail records (CDR).	
CON or NOCON	(Default: NOCON) Consume digits	Typical input: CON

ACHEAD (continued)**Digit string manipulation options (Sheet 2 of 3)**

Option	Refinements, values, and explanations
	<p>This option applies if the result of translations in the current stage points to further digit translation in the following stage.</p> <p>If this option is set not to consume leading digits required to index into the current stage, the digit string presented for translation in the following stage is the same as the digit string presented for translation in the current stage less any leading prefix (PF or CONSUME) digits.</p> <p>If this option is set to consume leading digits required to index into the current stage, the digit string presented for translation in the following stage is the same as the digit string presented for translation in the current stage less PF leading digits, that is, excluding the prefix digits, if any, and less the leading digits following the prefix digits, if any, required to index into the current stage.</p> <p>Note: This option does not affect the digit strings for call detail recording and outpulsing.</p>
AFTER	<p>AFTER (0 to 29) Number of digits to skip Typical input: AFTER 2</p> <p>This option is used with options DEL, INSRT, and REPL to define the number of leading digits to be skipped after the prefix digits before deleting, inserting, or replacing digits.</p> <p>All these operations affect all three-digit strings; that is, the digit string presented to the next translation stage, the call detail record digit string, and the outpulsed digit string.</p>
DEL	<p>DELDIGS (0 to 29) Number of digits to delete Typical input: DEL 2</p> <p>This option specifies the number of leading digits to be deleted from the digits string presented for translation in this stage after deleting PF leading digits and after skipping the prescribed number of digits.</p> <p>The digits to be deleted are processed by the DMS switch before inserting digits using the option INSRT.</p> <p>The digits are deleted from all three-digit strings, that is, the digit string presented to the next translation stage, the call detail record digit string, and the outpulsed digit string.</p>
INSRT	<p>INSRDIGS (string of up to 29 digits) Digits to insert Typical input: INSRT 27</p>

ACHEAD (continued)**Digit string manipulation options (Sheet 3 of 3)**

Option	Refinements, values, and explanations
	<p>This option specifies the digits to be inserted into the digit string presented for translation in this stage, after deleting PF leading digits and after skipping the prescribed number of digits.</p> <p>The digits to be deleted using option DEL are processed by the DMS switch before inserting digits.</p> <p>Digit replacement using option REPL cannot be done in the same tuple as digit insertion through option INSRT. If both options are datafilled, the second one in the tuple is used.</p> <p>The digits are inserted into all three-digit strings, that is, the digit string presented to the next translation stage, the call detail record digit string, and the outpulsed digit string.</p>
REPL	<p>REPLDIG (string of up to 30 digits) Replacement digits Typical input: REPL 4522453</p> <p>This option specifies the digits that are to replace those in the digit string presented for translation in this stage, after deleting PF leading digits and after skipping the prescribed number of digits.</p> <p>Digit replacement through option REPL cannot be done in the same tuple as digit insertion through option INSRT. If both options are datafilled, the second one in the tuple is used.</p> <p>The digit replacement occurs in all three-digit strings, that is, the digit string presented to the next translation stage, the call detail record digit string, and the outpulsed digit string.</p>
VPNREPL	<p>VPN Replace digits Typical input: VPNREPL</p> <p>Provides full Private Integrated Node Exchange (PINX) functionality on a public node. It is required to trigger translation on the virtual private network (VPN) number received in a parameter of an IAM/SGM message in a Q.VPN TCAP Setup.Invoke component.</p> <p>The VPNREPL option replaces the called party number with the VPN digits (private called party address) and continues translation.</p>
VPNXLT	<p>VPN Replace translation Typical input: VPNXLT</p> <p>The VPNXLT option replaces the translation system and translator name with the values from table BGIDMAP. The entry in table BGIDMAP is addressed by the NNI BGID and SIGNIFICANCE information received in the originating signaling for the call. The VPNXLT option and the XLT option cannot both exist in the same tuple.</p>

Universal translation tables options for screening and charging

The universal translation tables options for charging or screening, listed and described in the following table, can occur in one or more tables, as detailed on the following pages.

ACHEAD (continued)

In general, if the same option is found in two different tuples during a pass through translation, the value in the last tuple is used. For example, if option CLASS is set to LCL in table PXCOD, it can be reset to NATL in table FACOD.

Screening and charging options (Sheet 1 of 4)

Option	Refinements, values, and explanations
ACF	<p>ACF (0 to 29) Area code fence Typical input: ACF 3</p> <p>This option is used for inserting overdecadic connection control digits on China CAS trunks. No digits are prefixed or consumed before ACF processing. The digit position is recalculated after digit manipulation of the outpulsed digits.</p>
AMAXLAID	<p>XLAID Typical input: AMAXLAID FREE</p> <p>Automatic message accounting translations identification is used to indicate whether the international centralized automatic message accounting (ICAMA) record is generated with a signal DN or a public switched telephone network (PSTN) number. XLAID can be datafilled with the values FREE, GENERIC1, GENERIC2, or GENERIC3.</p>
CALLCTRL	<p>CALLCTRL (see list below) Call control Typical input: CALLCTRL LAST</p> <p>Calling control indicates which party has control of the release of a call. The following options are available:</p> <p>CALLING The calling party releases the call by going on-hook. If the called party goes on-hook and the calling party does not, the call is reconnected if the called party goes off-hook again before the reanswer timer expires.</p> <p>CALLED The called party releases the call by going on-hook. If the calling party goes on-hook and the called party does not, the call is reconnected if the calling party goes off-hook again before the reanswer timer expires.</p> <p>LAST The calling party or called party releases the call when the last one goes on-hook.</p> <p>MUTUAL The calling party or the called party releases the call when either party goes on-hook.</p>
CAMA	<p>CLDFMT (see list below) Typical input: CLCAMA CURRENT</p>

ACHEAD (continued)

Screening and charging options (Sheet 2 of 4)

Option	Refinements, values, and explanations
CLASS	<p>Centralized automatic message accounting is used for terminator billing through the translations tables. The options are:</p> <p>CURRENT This option indicates that an ICAMA record is produced with the signaled DN without translations.</p> <p>POSTXLA This option indicates that an ICAMA record is produced with the public switched telephone network (PSTN) number with translations.</p> <p>CLASS (see list below) Translation class Typical input: CLASS LCL</p> <p>The DMS-100 switch recognizes the following translation classes:</p> <p>ATT Attendant (business services only)</p> <p>CNTL Continental call (international call within the same continent)</p> <p>COLL Collect call</p> <p>DATT Dial attendant (business services only)</p> <p>EMRG Emergency call</p> <p>IAGRP Intragroup call (business services only)</p> <p>ICNTL Intercontinental call (international call to a different continent)</p> <p>INTL International call</p> <p>IOPRA International operator-assisted call</p> <p>LCL Local call</p> <p>NATL National call (within the nation, but nonlocal tariff)</p> <p>OPRA Operator-assisted call</p> <p>RURAL Rural call</p> <p>SPEC Special call (for example, repair service or call to operator)</p> <p>UNKW Unknown class (this can be used if the class cannot be determined yet, for example, ambiguous codes)</p> <p>URBAN Urban call</p>
LNET	<p>LNET (string in LNETWORK) Logical (metering) network Typical input: LNET LOCAL</p> <p>This option is used by the DMS international metering system to find a tariff for the call. This network is a string that must already be datafilled in table LNETWORK.</p>
MZONE	<p>MZONE (0 to 63) Metering zone Typical input: MZONE 2</p>

ACHEAD (continued)**Screening and charging options (Sheet 3 of 4)**

Option	Refinements, values, and explanations
NETSRV	<p>This option specifies the metering zone of the call in the logical network above. It is used by the DMS international metering system to determine a tariff for the call.</p> <p>NETSRV_NAMENetwork service name Typical input: NETSRV IPHS</p> <p>This option identifies a Japan network service. The entry in this field determines the parameters in an outgoing IAM message. The following network services are available:</p> <p>IPHS Identifies a call to an independent personal handyphone system (IPHS) subscriber</p> <p>DPHS Identifies a call to a dependent personal handyphone system (DPHS) subscriber</p> <p>MOBILE Identifies a call to a mobile subscriber</p> <p>DA Identifies a call to the directory assistance (DA) operator</p> <p>TELEGRAM Identifies a call to the Telegram office</p> <p>NCC Identifies a call routed to one of the following networks:</p> <ul style="list-style-type: none"> • New Common Carrier serving international toll traffic • New Common Carrier serving national toll traffic
PF	<p>PFDIGS (0 to 24) Number of prefix digits Typical input: PFDIGS 1</p> <p>This is the number of prefix digits in the digit strings presented to this stage for translation, call detail recording, and outpulsing. Prefix digits are not used to index any further translation tables and are not outpulsed, but they do remain stored in call detail records (CDR).</p>
PRESEL	<p>PRESELPreselection call processing</p> <p>This option provides a means of optionality for preselection and provides the necessary information used to index into table PCIXLA. The preselection call class (PRESELECT, OVERRIDE, or CALLTYPE) associated with each call depends on the xxCODE table datafill that is used.</p>
PRIVL	<p>If the entry in PRIVL is N (no) or is omitted, the call is not affected by this option.</p> <p>If the entry in PRIVL is Y (yes), calls from privileged originators (for example, operators) can proceed, whereas calls from non-privileged originators are treated as if no match for the digits dialed is found so that the default prescription of table (XLASYS)HEAD field DFLT is taken, which is usually datafilled to block the call by sending it to treatment VACT (vacant code).</p>

ACHEAD (continued)**Screening and charging options (Sheet 4 of 4)**

Option	Refinements, values, and explanations
PCC	<p>This allows two classes of originator to use the same translation tables if the privileged user can dial all the same codes as a non-privileged user as well as some other privileged codes. The privileged user is given full access to all the codes, while the ordinary subscriber is prevented from using the privileged codes. This saves datafill, because otherwise two copies of all the codes would have to be datafilled.</p> <p>PCCDR (string of 3 digits) Pseudo country code Typical input: PCC 057</p> <p>The pseudo country code (PCC) is used to record a particular pseudo country code. This can be extracted for use by system logic later, for example two-stage outputting. It can be entered as an option in the CODE tables with both the CONT (continue) and RTE (route) selectors. Its parameter is a three-digit decimal number that represents the PCC. If a two-digit PCC is required, it must be padded with a leading zero.</p>
QFT	<p>QSIG Feature Transparency Typical input: QFT ON or OFF</p> <p>The QFT ON and QFT OFF option determine if an outgoing route is capable of QFT. If QFT ON is entered, the following checks are performed during translation:</p> <ul style="list-style-type: none"> • identify if QFT information can be transported over an outgoing route • trigger the gateway function (take call down) if the QFT option is missing or set to OFF for a QFT-call <p>Note: QFT ON must only be entered if the far-end node is QFT-capable.</p>

China offices with C1 MFC trunks

In local offices with the Chinese #1 (C1) multifrequency compelled (MFC) trunks, the translation class determines which KD signal (Kx signals are used in the Chinese No. 1 trunk signaling for national calls) is sent forward, as shown below.

- If the CLASS is CNTL, ICNTL, INTL, or NATL, a KD = 2 signal is sent forward.
- If the CLASS is other than CNTL, ICNTL, INTL, or NATL, a KD = 3 signal is sent forward.

Offices other than originating local offices get their KD information from previous offices rather than through translation datafill. If the KD information cannot be obtained from a previous office, the translation system can be used.

At an originating toll office, the translation must be set to international or intercontinental (CLASS is INTL or ICNTL) for international calls (that is,

ACHEAD (continued)

calls in which the subscriber prefixed a 00), for the originating toll to distinguish between a KA and a KOA from the originating local office.

Line-to-trunk reanswer timing

The translation class determines the reanswer timing for line-to-trunk calls, as shown below.

- If the CLASS is ATT, DATT, IAGRP, LCL, RURAL, UNKW, or URBAN, the duration of reanswer timing is found in office parameter LINE_LOCAL_CALL_REANS_TMO in table OFCVAR.
- If the CLASS is EMRG, or SPCL, the duration of reanswer timing is found in office parameter LINE_SPCL_CALL_REANS_TMO in table OFCVAR.
- If the CLASS is CNTL, ICNTL, INATL, or NATL, the duration of reanswer timing is found in office parameter LINE_TOLL_CALL_REANS_TMO in table OFCVAR.
- If the CLASS is IOPRA, OPRA, or other not listed above, there is no reanswer timing.

Line-to-trunk toll no-answer timing

The translation class determines the no-answer timing for line-to-trunk toll calls as specified in table PREANSTO.

Line-to-line reanswer timing

The translation class determines the reanswer timing for line-to-line calls as shown below.

- If the CLASS is ATT, DATT, IAGRP, LCL, RURAL, UNKW, or URBAN, the duration of reanswer timing is found in office parameter LINE_LOCAL_CALL_REANS_TMO in table OFCVAR.
- If the CLASS is EMRG, or SPCL, the duration of reanswer timing is found in office parameter LINE_SPCL_CALL_REANS_TMO in table OFCVAR.
- If the CLASS is CNTL, ICNTL, INATL, IOPRA, NATL, OPRA, or other not listed above, there is no reanswer timing.

China local and toll busy

If an incoming Chinese #1 (C1) multifrequency compelled (MFC) trunk routes to a busy subscriber, the call that the subscriber is already involved in must be looked at to determine whether the subscriber is local busy or toll busy.

ACHEAD (continued)

If the originating agent of the call is a line, the translation class determines whether the call is local or toll busy as shown below.

- If the CLASS is CNTL, ICNTL, INTL, or NATL, the call is considered toll busy.
- If the CLASS is other than CNTL, ICNTL, INTL, or NATL, the call is considered local busy.

Universal translation tables options for routing

The universal translation tables routing options are described below.

Translation tables routing options (Sheet 1 of 8)

Selector	Refinements, values, and explanations
XLASEL	Table xxHEAD, field DFLT, and table xxCODE, field XLADATA, have identical formats. The format consists of a translation selector, a group of options for routing, digit manipulation, screening, and charging.
	CONT Typical input: CLASS
	This option specifies that translation continues in a translation system code table (xxCODE) using the translation name (XLANAME) after processing the other options in the same tuple.

ACHEAD (continued)**Translation tables routing options (Sheet 2 of 8)**

Selector	Refinements, values, and explanations
	<p>CONT has the following options:</p> <ul style="list-style-type: none"> • ACF Area Code Fence • AMAXLAID Automatic message accounting XLA ID • BLKOVLP Block Overlap Outpulsing • CALLCNTL Call control • CAMA Centralized automatic message accounting • CATRTE Category routing • CDN Called Number • CDNRTE Called Number Route • CLASS Translation class • CLIOVRD Calling Line Identity Override • CONSUME Consume digits • CPCRTE Calling Party Category Route • DDIDX Destination Discount Index • DEST Destination • DESTOM Destination and route based OMs • EXTCIC External Carrier identification code • IAA Interadministration accounting • LNET Logical network name • MM Minimum and maximum number of digits expected • MZONE Metering zone • NETINFO Netinfo support • NETSRV Network service • NICRF NIC routing function • NTAIO Network Translated Address Indicator Origination • OSS Operator Service System • PCC Pseudo Country Code • PF Prefix fence • PNRF Ported Number Recognition Function • PORTED Ported number indicator • PRESEL Preselection call processing
DMS-100 Family NAMO Control Data	<p>Schema Reference Manual Volume 1 of 12 LET0015 and up</p> <ul style="list-style-type: none"> • QFT QSIG Feature Transparency

ACHEAD (continued)**Translation tables routing options (Sheet 3 of 8)**

Selector	Refinements, values, and explanations
	<ul style="list-style-type: none"> • SETCDN Set Called Number Name • TOC Type of charge • VPN Operate the PINX • XLT Translate
DBQ	<p style="text-align: right;">Typical input: NSC</p> <p>This option specifies that translation continues in a translation system code table (xxCODE) using the translation name (XLANAME) after processing the other options in the same tuple.</p> <p>DBQ has the following options:</p> <ul style="list-style-type: none"> • MM Minimum and maximum digits • NSC Number service code • PF Prefix fence
DMOD	<p style="text-align: right;">Typical input: DEL</p> <p>This option specifies that translation continues in a translation system code table (xxCODE) using the translation name (XLANAME) after processing the other options in the same tuple to modify the digit string.</p>

ACHEAD (continued)**Translation tables routing options (Sheet 4 of 8)**

Selector	Refinements, values, and explanations
	<p>DMOD has the following options:</p> <ul style="list-style-type: none"> • AFTER Insert after • CATRTE Category routing • CDNRTE Called number route • CONSUME Consume digits • CPCRTE Calling party category route • DEL Delete digits • DESTOM Destination and route based OMs • EXTCIC External carrier identification code • INSRT Insert digits • PF Prefix fence • RBP Ringback price • REPL Replace digits • SETCDN Set called number • VPNREPL Virtual Private Network replace digits • VPNXLT Virtual Private Network replace translation • XLT Translation <p>DNRTE Typical input: MM</p> <p>This option specifies that translation continues to the DNINV table at AREACODE, DFCCODE (as datafilled in option DN).</p> <p>DNRTE has the following options:</p> <ul style="list-style-type: none"> • ALLOWOVLP Allow overlap • AMAXLAID Automatic message accounting XLA ID • CAMA Centralized automatic message accounting • CLASS Translation class • DN Directory number • MM Minimum and maximum number of digits expected • PF Prefix fence • SF Station fence

ACHEAD (continued)

Translation tables routing options (Sheet 5 of 8)

Selector	Refinements, values, and explanations
FEAT	<p data-bbox="1138 432 1357 457">Typical input: FTR</p> <p data-bbox="383 489 959 514">This option specifies an international line feature.</p> <p data-bbox="383 546 756 571">FEAT has the following options:</p> <ul data-bbox="383 594 1097 814" style="list-style-type: none"> <li data-bbox="383 594 837 619">• FTR Vertical service code (VSC) <li data-bbox="383 642 703 667">• FUNC Function code <li data-bbox="383 690 1097 716">• MM Minimum and maximum number of digits expected <li data-bbox="383 739 638 764">• PF Prefix fence <li data-bbox="383 787 724 812">• XLT Translation system <p data-bbox="383 844 821 869">FEATINFO has the following options:</p> <ul data-bbox="383 892 902 1255" style="list-style-type: none"> <li data-bbox="383 892 756 917">• VSC Vertical service code <li data-bbox="383 940 902 966">• VALIDATE Validate (not used in GL03) <li data-bbox="383 989 703 1014">• CALLBACK Call back <li data-bbox="383 1037 732 1062">• CALLCHAR Call charge <li data-bbox="383 1085 740 1110">• CLCTDIGS Collect digits <li data-bbox="383 1134 797 1159">• JES Japan Emergency Service <li data-bbox="383 1182 865 1207">• NTC Notification of time and charge <li data-bbox="383 1230 651 1255">• TLC Test line call
HRC	<p data-bbox="1138 1287 1390 1312">Typical input: PFBILL</p> <p data-bbox="383 1344 1292 1402">This option specifies that translation continues to the current xxCODE table at XLANAME, after processing the other option in the same tuple.</p> <p data-bbox="383 1434 748 1459">HRC has the following options:</p> <ul data-bbox="383 1482 764 1556" style="list-style-type: none"> <li data-bbox="383 1482 764 1507">• PFBILL Prefix fence billing <li data-bbox="383 1530 719 1556">• XLT Translations table
IAC	<p data-bbox="1138 1587 1333 1612">Typical input: PF</p> <p data-bbox="383 1644 1292 1703">This option specifies that translation continues to the current xxCODE table at XLANAME, after processing the other option in the same tuple.</p> <p data-bbox="383 1734 732 1759">IAC has the following options:</p> <ul data-bbox="383 1782 634 1808" style="list-style-type: none"> <li data-bbox="383 1782 634 1808">• PF Prefix fence

ACHEAD (continued)

Translation tables routing options (Sheet 6 of 8)

Selector	Refinements, values, and explanations
	<p data-bbox="383 489 440 516">RTE</p> <p data-bbox="1138 489 1377 516">Typical input: DEST</p> <p data-bbox="383 548 1398 606">This option specifies that translation continues to the current xxRTE table at XLANAME and specified route index DEST, after processing the other option in the same tuple.</p>

ACHEAD (continued)

Translation tables routing options (Sheet 7 of 8)

Selector	Refinements, values, and explanations
	<p>RTE has the following options:</p> <ul style="list-style-type: none"> • ACF Area code fence • AMAXLAID Automatic message accounting XLA ID • BLKOVLP Block overlap • CAMA Centralized automatic message accounting • CALLCTRL Call control • CATRTE Category routing • CDN Called number • CDN RTE Called number route • CHGIND change indicator • CLASS Translation class • CONSUME Consume digits • CPCRTE Calling party category route • DDIDX Destination discount index • DEST Destination • DESTOM Destination and route based OMs • EXTCIC External carrier identification code • IAA Interadministrative accounting • LNET Logical network name • MM Minimum and maximum number of digits expected • MZONE Metering zone • NETINFO Netinfo support • NETSRV Network service • NTAIO Network Translated Address Indicator Origination • PCC Pseudo country code • NICRF NIC routing function • PF Prefix fence • PIP Peripheral interchange process • PNRF Ported number recognition function • PORTED Ported number indicator • PRESEL Preselection call processing
297-8021-351	<p>Standard RTE Preselection route</p> <ul style="list-style-type: none"> • PRIVL Privileged

ACHEAD (continued)**Translation tables routing options (Sheet 8 of 8)**

Selector	Refinements, values, and explanations
	<ul style="list-style-type: none"> • QFT QSIG Feature Transparency • SETCDN Set called number • TOC Type of charge • VPN Operate PINX • VPNPAN Operate the PINX as a Public Address Node (PAN)
TRMT	<p style="text-align: right;">Typical input OFC</p>
	<p>This option specifies that translation proceeds to table TMTCNTL, subtable OFFTREAT at TREATMT. TRMT is a known exception or failure condition.</p>
	<p>TRMT has the following options:</p>
	<ul style="list-style-type: none"> • DESTOM Destination and route based OMs • OFC Office

Universal translation tables datafill sequence

Within a particular translation system, an xxHEAD table tuple must be datafilled before the corresponding xxCODE or xxRTE tables. This is because the XLANAME does not exist until it is defined in the xxHEAD table. Similarly, an XLANAME cannot be referenced (with option XLT) from another table until it is defined in the xxHEAD table of its own translation system. For example, option XLT OFC OFC1 cannot be datafilled in table PXC CODE until a tuple with XLANAME OFC1 has been defined in table OFCHEAD.

Miscellaneous notes

If an entry is deleted from a HEAD table, all CODE and RTE table entries with the given XLANAME are also deleted. However, all XLT references to the deleted XLANAME in other tables must be removed manually. If references to deleted XLANAMES are not removed, translation cannot continue when it reaches the missing reference, and a call dump occurs. This applies to all universal translation systems.

Tables TRKGRP and NETATTR are also affected.

ACHEAD (continued)

This document covers the information required to datafill the following universal translations xxHEAD tables:

- TERMINFO
- ACHEAD
- AMHEAD
- CTHEAD
- FAHEAD
- FTHEAD
- OFCHEAD
- PXHEAD

Functional description

The head tables define the instances of CODE and RTE tables and their characteristics. All HEAD tables have an identical format for the options they contain.

Datafill sequence and implications

If field XLASEL (translation selector) is datafilled with DBQ, table NSCDEFS must be datafilled before table ACHEAD.

If the optional selector CGNDM is used with translation selector DMOD, the default calling line identification (CLI) must be datafilled in table TRKSGRP. Different default CLIs can be datafilled on requirements.

Optional selector CGNDM must also be datafilled in table ACCODE to activate feature AQ0987 (Calling-Party-Number Digit Manipulation).

When datafilling the xxHEAD and xxCODE tables, if translation selector DNRTE is used, table DNINV must be datafilled before table ACHEAD. If option AMAXLAID is also used with selector DNRTE, or CONT or RTE, table AMAXLAID must be datafilled before table ACHEAD.

Table ACHEAD interacts with the following office parameters in table OFCVAR:

- ICAMA_REQUESTED
- IAA_REQUESTED
- IMEI_ACCEPTABLE_FOR_EMRG_CALL

ACHEAD (continued)

For the option selector CAMA, used in translation selectors CONT, DNRTE, and RTE, set office parameter ICAMA_REQUESTED to Y (yes) in table OFCVAR if international centralized automatic message accounting (ICAMA) detailed call recording is required.

An international automatic accounting (IAA) record can be generated by selecting office parameter IAA_REQUESTED in table OFCVAR, and the CAMA selector.

Office parameter IMEI_ACCEPTABLE_FOR_EMERG_CALL in table OFCVAR provides an option for the network operator to accept emergency call setups from mobile stations that transmit the international mobile equipment identifier (IMEI) instead of the international mobile subscriber identifier (IMSI) or temporary mobile subscriber identifier (TMSI). The default value allows emergency call setups with IMEI as the identifier if, for example, no serial interface module (SIM) is present.

Only automatic number identification (ANI) and international metered (MTR) trunk group originations currently support option selector CAMA. All other call types ignore this translation option.

For emergency call translation, class EMERG must be datafilled. This can be done before or after translation selector DMOD with option selector COODM. This requirement differentiates between normal mobile-originated calls and emergency calls setup by a conventional SETUP message.

If options CDNRTE and CPRTE are both present in one tuple in table xxHEAD, call processing accesses routing tables in the following order: table CPCUXLA is accessed first. If no match is found, table CDNUXLA is accessed next.

If options SETCDN and CDNRTE are both present in one tuple in table xxHEAD, call processing accesses table CDNUXLA first, before the SETCDN option sets the called number name (CDNNAME).

Option NETINFO can only be added to selectors CONT and RTE if the option QFT ON is datafilled in the same tuple for which the option NETINFO is added.

Datafill guidelines

A tuple in an xxHEAD table consists of the name of the xxCODE and xxRTE tables, and some or all of the xxHEAD table options listed below:

- DFLT (xxCODE table tuple)
- DFOP (xxCODE table options)

ACHEAD (continued)

- CON (consume)
- MAXIDX (hexadecimal digit)

The options entered at the DFLTSEL prompt define DFLT.

The options entered at the DFOPSEL prompt define DFOP.

The options entered at the XLASYS prompt define TABREF.

A description of each option is given in the following table.

xxHEAD table options (Sheet 1 of 2)

Option	Descriptions
DFLT	<p>DEFAULT</p> <p>Translation uses this data if the dialed digits are not datafilled in the xxCODE table associated with this xxHEAD tuple. Any valid xxCODE table tuple can be specified with this option.</p>
DFOP	<p>DEFAULT OPTIONS</p> <p>If dialed digits use a RTE or CONT selector, any options not datafilled against the digits can be defaulted to the value specified here. This facility, and the DFLT option, are intended to minimize the amount of datafill required in any given xxCODE table, especially if most of the expected xxCODE tables have the same attributes. If an option is applicable to most, but not all, tuples in the xxCODE table, the option can still be datafilled in the default options. Options datafilled in the xxCODE table tuples override the options in the xxHEAD table, so that different values can be datafilled into those xxCODE tuples to which the default option does not apply.</p>
CON	<p>CONSUME DIGITS</p>

ACHEAD (continued)**xxHEAD table options (Sheet 2 of 2)**

Option	Descriptions
	This option applies to the CONT selector of an xxCODE table. The default case is not to consume digits. That is, the next table is indexed using the same digits as the current table, except for ignoring prefix digits. Under certain conditions, the next table is indexed starting with the digits following the index to the current table (translations absorb or consume the current index digits). For example, an area code is found in table FACODE. Table OFCCODE is indexed with the digits following the area code (the office code), so the digits used to index table FACODE are consumed. This does not mean that the digits are deleted from the digit register. They are still there and are outputted unless explicitly deleted in the xxCODE or xxRTE tables. The CON option means that these digits are not used to index the next table.
MAXIDX	<p>MAXIMUM INDEX</p> <p>The translation tables are indexed by dialed digits. These digits default to the range of 0 to 9. Certain xxCODE tables can be datafilled to include hex B (*), hex C (#), or the range 0 to 9 and hex digits B, C, D, E, and F in the index. For example, feature access codes can have format *XX (where * is hex B). B is specified in field MAXIDX in the xxHEAD table.</p>

Table size

Memory is automatically allocated to a maximum of 2047 tuples. The size is initially set to 64 and the table extends automatically.

Datafill

The following table lists datafill for table ACHEAD. Tables ACCODE and ACRTE are referenced. However, any valid system prefix can be used in each set of tables.

Field descriptions (Sheet 1 of 3)

Field	Subfield	Entry	Explanation and action
XLANAME		alphanumeric (1 to 8 characters)	Translation name. Enter the name assigned to the universal translator.
CONTMARK		+	Continuation mark. Enter + to indicate that additional information for this tuple is contained in the next record.

ACHEAD (continued)**Field descriptions (Sheet 2 of 3)**

Field	Subfield	Entry	Explanation and action
DFLT		see subfield	Default translations data. This is the result that translations uses if the dialed digits are not datafilled in the ACCODE table associated with table ACHEAD. This field consists of subfield DFLTSEL and refinements dependent on the entry in field DFLTSEL.
	DFLTSEL	DFLT or SDFLT	<p>Default selector. Enter DFLT and datafill refinement XLASEL if the standard default is not correct.</p> <p>Enter SDFLT, if a standard default is required for dialed digits not found in the ACCODE table. The standard default is TRMT OFC VACT. That is, if dialed digits are not found in ACCODE, the call is routed to vacant code treatment. No additional datafill is required.</p>
	XLASEL	CONT, DBQ, DMOD, DNRTE, FEAT, FEATINFO, HRC, IAC, RTE, or TRMT	<p>Translations selector.</p> <p>Enter CONT and datafill refinement CONT if further translation is required.</p> <p>Enter DBQ and datafill refinement DBQ to perform a database query.</p> <p>Enter DMOD and datafill refinement DMOD if input digit stream modification is required.</p> <p>Enter DNRTE and datafill refinement DNRTE if input digit routing is required.</p> <p>Enter FEAT and datafill refinement FEAT if access to a feature is required.</p> <p>Enter FEATINFO and datafill refinement FEATINFO to trigger the screening function.</p> <p>Enter HRC and datafill its refinements if the home routing code selector is required for local number portability applications.</p>

ACHEAD (continued)**Field descriptions (Sheet 3 of 3)**

Field	Subfield	Entry	Explanation and action
			<p>Enter IAC and datafill refinement IAC if the insertion of own area code is required when an ambiguous area code is found through translations.</p> <p>Enter RTE and datafill refinement RTE if a translation result was found, and translation is to terminate.</p> <p>Enter TRMT and datafill refinement TRMT if a call is routed to a treatment.</p>
	DFOP	DFOP or NODFOP	<p>Default options. Enter DFOP and datafill subfield OSEL and its refinements.</p> <p>The default options apply only if a tuple with field XLASEL set to RTE or CONT is chosen in the CODE table.</p> <p>If the entry in field DFOP is equal to DFOP, this field is a vector that consists of a number of options. Each option, consisting of subfield OSEL and refinements dependent on the entry in subfield OSEL, is separated from the next by a space. The various refinements are identical to the refinements described in field DFLT, selector CONT, subfield OSEL.</p> <p>For each option, specify the option selector, followed by a space, and the refinements, with each refinement separated from the next by a space. The entry is concluded by a \$ and datafill continues with field CON.</p> <p>Enter NODFOP if there are no default options and datafill field CON.</p>

XLASEL = CONT

If the entry in field XLASEL is CONT, datafill the following refinements.

ACHEAD (continued)

Table AMAXLAID must be datafilled prior to selecting option AMAXLAID in field OSEL.

ACHEAD (continued)

Field descriptions for conditional datafill (Sheet 1 of 17)

Field	Subfield	Entry	Explanation and action
	OPT	see subfield	Options. This field is a vector consisting of up to ten options. Each option consists of subfield OSEL and refinements that depend on the entry in subfield OSEL. For each option, specify the option selector (OSEL), followed by a space, and the refinements, each separated by a space. The entry is concluded by a \$ and datafill continues with field DFOP.

ACHEAD (continued)**Field descriptions for conditional datafill (Sheet 2 of 17)**

Field	Subfield	Entry	Explanation and action
	OSEL	ACF, AMAXLAID, CALLCTRL, CALLDUR, CAMA, CATRTE, CDN, CDNRTE, CHGIND, CLASS, CLIOVRD, CONSUME, CPCRTE, CPMCALL, DDIDX, DEST, DESTOM, DFT, EXTCIC, IAA, LNET, MM, MZONE, NETINFO, NETSRV, NICRF, NOANSTIM, NTAIO, NTAIT, OSS, PCC, PF, PNRF, PORTED, PRESEL, PRIVL, QFT, SETCDN, TELETAXE, TOC, VPN, XLT	<p>Option selector. The following options can be selected:</p> <p>Enter ACF, followed by a space, and datafill refinement ACF if the area code fence is defined.</p> <p>Enter AMAXLAID, followed by a space, and datafill refinement XLAID to specify an automatic message accounting (AMA) identity from within table AMAXLAID.</p> <p>Enter CALLCTRL, followed by a space, and datafill refinement CALLCTRL. The entry in refinement CALLCTRL indicates who has control of the call: the calling party, the called party, or both.</p> <p>Enter CALLDUR, followed by a space, and datafill requirement CALL_DURATION_TIMER. The entry in refinement CALL_DURATION_TIMER defines the call time limit for Premium Rate Service calls.</p> <p>Enter CAMA, followed by a space, and datafill refinement CLDFMT. The entry in field CLDFMT indicates whether the international centralized automatic message accounting (ICAMA) record is generated with the originally signaled directory number (DN) or the final public switched telephone network (PSTN) number.</p> <p>Enter CATRTE to allow charge category routing in IBN translations.</p> <p>Enter CDN, followed by a space, and datafill refinement CDN to select the nature of address field. This field is used to identify the called party of the initial address message (IAM). It is used for Australian ISDN user part (AISUP) call translations.</p>

ACHEAD (continued)**Field descriptions for conditional datafill (Sheet 3 of 17)**

Field	Subfield	Entry	Explanation and action
			<p>Enter CDN RTE to route using the called number name (CDNNAME) from table CDNCHAR. If the CDNNAME is present on the incoming call or is set by the SETCDN option, translation proceeds to table CDNUXLA.</p>
			<p>Enter CHGIND, followed by a space and datafill refinement CHGIND to override the charge indicator value received from an incoming trunk message. This entry is specific to JCTV.</p>
			<p>Enter CLASS, followed by a space, and datafill refinement CLASS if the class of the dialed digits can be determined.</p>
			<p>Enter CLIOVRD, followed by a space, and enter data for refinement CLIOVRD. This subfield indicates calling line identity override.</p>
			<p>Enter CONSUME, followed by a space, and datafill refinement CONDIGS to specify the number of digits that are consumed during translation.</p>
			<p>Enter CPC RTE to route using the calling party category (CPCNAME) from table CPCCHAR. If the CPCNAME is present on the incoming call, translation proceeds to table CPCUXLA.</p>
			<p>Enter CPMCALL, followed by a space, and datafill refinement CPMCALL to specify call billing against the called party instead of the calling party for intra-office calls.</p>
			<p>Enter DDIDX, followed by a space, and enter data for refinement DDIDX. Enter data for this subfield for the destination discount index.</p>
			<p>Enter DEST, followed by a space, and datafill refinement DEST if the destination is known.</p>
			<p>Enter DESTOM in order to associate a destination OM name with a particular destination.</p>

ACHEAD (continued)

Field descriptions for conditional datafill (Sheet 4 of 17)

Field	Subfield	Entry	Explanation and action
			<p>Enter DFT for DPNSS feature transparency functionality. Operates in conjunction with the QFT option (see later). QFT must be ON.</p>
			<p>Enter EXTCIC, followed by a space, and enter data for refinements CICSIZE, SKIPDIGS, or SOURCE. Enter EXTCIC for the external carrier identification code</p>
			<p>Enter IAA and the datafill refinement IAA_INDEX to generate or modify IAA message parameters based on datafill in table IAACtrl.</p>
			<p>Enter LNET, followed by a space, and datafill refinement LNET if a logical network is required for metering.</p>
			<p>Enter MM, followed by a space, and datafill refinements MIN and MAX if the minimum and maximum dialed digits are known.</p>
			<p>Enter MZONE, followed by a space, and datafill refinement MZONE if metering is to be done on the call.</p>
			<p>Enter NETINFO to ensure that the customer group identifier and NCOS are transported to the terminating node to trigger the private IBN translations in a VPN. The private IBN translations are invoked only if options VPNXLT and IBNRX are datafilled at the terminating node.</p>
			<p>Enter NETSRV and datafill refinement NETSRV_NAME to indicate a Japan network service.</p>
			<p>Enter NICRF to activate the Network Identification Code (NIC) routing function. Note that the NICRF and PNRF options are incompatible and cannot be datafilled on the same tuple.</p>
			<p>Enter NOANSTIM to the RTE selectors. This turns the T9 timer off in the outgoing ISUP trunk, if encountered.</p>

ACHEAD (continued)**Field descriptions for conditional datafill (Sheet 5 of 17)**

Field	Subfield	Entry	Explanation and action
			<p>Enter NTAIO to mark call destination.</p> <p>Enter NTAIT to mark call destination.</p> <p>Enter OSS for the operator signaling service. The OSS subfield does not have refinements.</p> <p>Enter PCC, followed by a space, and datafill refinement PCCDR if a pseudo country code is required.</p> <p>Enter PF, followed by a space, and enter data for refinement PFDIGS. Enter data for this subfield if the digit stream contains prefix digits.</p> <p>Enter PORTED to indicate that a previous node identified that this call is to a ported number.</p> <p>Enter PNRF to invoke the ported number recognition function.</p> <p>Enter INSNG and its subfields.</p> <p>Note that the NICRF and PNRF options are incompatible and cannot be datafilled on the same tuple.</p> <p>Enter PRESEL, followed by a space, and datafill refinement PRESEL to provide the necessary information used to index into the PCIXLA table.</p> <p>Enter PRIVL, followed by a space, and datafill refinement PRIVL if the user is a privileged user (for example, operators).</p> <p>Enter QFT followed by ON or OFF to indicate if an outgoing route is capable of QSIG Feature Transparency.</p> <p>Note: The QFT ON option must not be added to a route unless the far-end node is QFT-capable.</p>

ACHEAD (continued)**Field descriptions for conditional datafill (Sheet 6 of 17)**

Field	Subfield	Entry	Explanation and action
			<p>Enter SETCDN to trigger the setting of outgoing called party characteristics. This option assigns the called number name (CDNNAME) from table CDNCHAR to the call. If the CDNRTE option is subsequently encountered, the CDNNAME is used to route the call.</p> <p>You can use the SETCDN option to allow CDN routing when incoming agents such as DPNSS or BTUP are not available in table CDNCHAR.</p> <p>Enter TELETAXE. This subfield does not have refinements.</p> <p>Enter TOC, followed by a space, and datafill refinement CHG for the type of charge if the type of charge messaging is selected.</p> <p>Enter VPN, followed by a space, and datafill refinements ONNET and BILLABLE if the call routes through a service switching point (SSP) and the Australian VPN - SSP feature is present in the switch.</p> <p>Enter XLT, followed by a space, and datafill refinement XLASYS if the call is to proceed to another translation system.</p>
	ACF	0 to 29	Area code fence. If the entry in subfield OSEL is ACF, datafill this refinement. Enter the number of digits between the beginning of the digits to currently index the table, and the end of the area code.
	BILLABLE	Y or N	Virtual private network billable call. If the entry in subfield OSEL is VPN, datafill this refinement. Enter Y if an AMA record is required for each VPN call. Otherwise, enter N. An AMA record is not generated if an address complete message (ACM) of address complete - no charge is returned, or if the call terminates in the SSP on a line with the free number terminating (FNT) option.

ACHEAD (continued)

Field descriptions for conditional datafill (Sheet 7 of 17)

Field	Subfield	Entry	Explanation and action
		PRESELECT OVERRIDE, CALLTYPE, CSN, or TRUNK	<p>Preselection call processing. If the entry in subfield OSEL is PRESEL, datafill this refinement. Enter the preselection call class type that is associated with the call. For charge category routing, enter CALLTYPE.</p> <p>Note: Calltype CSN and TRUNK are available under the PRESEL option. These call classes are not needed for German Carrier Selection, and are not supported. The same applies to the Continue option of CONT. For the German market only, NOCONT is supported.</p>
	CALLCTRL	CALLED, CALLING, LAST, or MUTUAL	<p>Call control. If the entry in subfield OSEL is CALLCTRL, datafill this refinement. Enter one of the following values to specify the party controlling the call:</p> <ul style="list-style-type: none"> If the entry is CALLED and the called party goes on-hook first, the call is released immediately. If the calling line goes on-hook first and does not reanswer, the connection is not released until the called line goes on-hook. There are no time-outs, and the calling party is allowed to reanswer until the called line goes on-hook. <p>Calls to lines with option ESG must have CALLCTRL(CALLED).</p> <p>Calls terminating on an International Traffic Operator Position System (ITOPS) must have CALLCTRL (CALLED).</p>

ACHEAD (continued)

Field descriptions for conditional datafill (Sheet 8 of 17)

Field	Subfield	Entry	Explanation and action
	CALLCTRL (continued)		<p>Call control (continued). Enter one of the following values to specify the party controlling the call:</p> <ul style="list-style-type: none"> • If the entry is CALLING and the calling line goes on-hook first, the call is released immediately. If the called line goes on-hook first, the called party is allowed to reanswer within a datafilled reanswer time-out or until the calling line goes on-hook. If the time-out expires or if the calling line goes on-hook, the calling party releases the call and the called party is set to idle. • If the entry is LAST, the call is released when the later of the called party or the calling party goes on-hook. If either party goes on-hook, that party is allowed to reanswer within a datafilled reanswer time-out or until both parties go on-hook. • If the entry is MUTUAL and either line goes on-hook, the call is released immediately.
	CDNNAME	alphanumeric string	<p>If the entry in subfield OSEL is SETCDN, enter data for refinement CDNNAME. Enter CDNNAME to route the call using a called number name from table CDNCHAR.</p>
	CHG	SEND_ CHARGE or SEND_NO_ CHARGE	<p>Charge. If the entry in subfield OSEL is TOC, datafill this refinement. Enter SEND_CHARGE to set the answer message (BTUP ANM) type of answer (TOA) string sent out from a node to SEND_CHARGE. Enter SEND_NO_CHARGE to set the answer message (BTUP ANM) type of answer (TOA) string sent out from a node to SEND_NO_CHARGE.</p>

ACHEAD (continued)**Field descriptions for conditional datafill (Sheet 9 of 17)**

Field	Subfield	Entry	Explanation and action
	CHGIND	ASIS, CHG, or NOCHG	<p>CHGIND indicates whether to override the value of the charge indicator in the Backward Call indicators.</p> <p>Datafill the CHGIND field with the following values:</p> <ul style="list-style-type: none"> • ASIS—treat charge indicator as is • CHG—treat charge indicator as charge • NOCHG—treat charge indicator as no charge
	CICSIZE	1 to 4	<p>CIC size. If the entry in subfield OSEL is EXTCIC, enter data for this refinement. This field indicates the number of digits in the CIC. This field operates on the B (called) number, so it is assumed that the switch signals the CIC as part of the B number.</p> <p>The MAP display indicates the range is 0 to 4. The system does not allow a 0 entry.</p>

ACHEAD (continued)**Field descriptions for conditional datafill (Sheet 10 of 17)**

Field	Subfield	Entry	Explanation and action
	CLASS	ATT, CNTL, COLL, DATT, EMRG, IAGRP, ICNTL, INTL, IOPRA, LCL, NATL, OPRA, RURAL, SPEC, UNKW, or URBAN	<p>Translation CLASS. If the entry in subfield OSEL is CLASS, datafill this refinement. Enter the translation class determined by the dialed digits, as listed below. (This can be used for screening or billing purposes as described under CLASS in screening and charging options.)</p> <ul style="list-style-type: none"> • ATT (attendant console) • CNTL (continental) • COLL (collect) • DATT (dial attendant) • EMRG (emergency) • IAGRP (interagent group) • ICNTL (intercontinental) • INTL (international) • IOPRA (international operator assisted) • LCL (local) • NATL (national) • OPRA (operator assisted) • RURAL (rural) • SPEC (special) • UNKW (unknown) • URBAN (urban)
	CLDFMT	CURRENT or POSTXLA	<p>Called format. If the entry in subfield OSEL is CAMA, enter either CURRENT or POSTXLA to produce the required ICAMA record format.</p> <p>If the entry is CURRENT, an ICAMA record is produced with the signaled DN (without translation).</p> <p>If the entry is POSTXLA, an ICAMA record is produced with a public switched telephone network (PSTN) number resulting from translations.</p>

ACHEAD (continued)**Field descriptions for conditional datafill (Sheet 11 of 17)**

Field	Subfield	Entry	Explanation and action
	CLIOVRD	CNA, CNB	Calling line identity override. If the entry in subfield OSEL is CLIOVRD, enter data for this refinement. Enter CNA to allow the calling number for each call. Enter CNB to block the calling number for each call.
	CONDIGS	0 to 29 digits	Consumed digits. If the entry in subfield OSEL is CONSUME, datafill this refinement. Enter a number to explicitly define the number of digits consumed during call processing.
	CONTINUE	CONT, NOCONT	Continue. If the entry in subfield OSEL is PRESEL, enter data for this refinement. Enter CONT to continue translations through UXLA. Enter NOCONT to route translations through PCIXLA or PCITRK.
	CPMCALL	Y or N	Called party metering. If the entry in subfield OSEL is CPMCALL, datafill this refinement. Enter Y (yes) if calls are billed against the called party for intra-office calls. Enter N (no) for the default value of billing against the calling party for intraoffice calls.
	DDIDX	1 to 63 or DEFAULT	Destination discount index. If the entry in subfield OSEL is DDIDX, enter data for this refinement. Enter the destination discount index number from table ACOOPT.
	DEST	0 to 1023	Destination route list index. If the entry in subfield OSEL is DEST, datafill this refinement. Enter the number in the route list of the translation system that the call is routed to.
	DESTOM	Destination OM names that are datafilled in table TERMINFO (16 character vector).	Destination and route based OMs. If the entry in subfield OSEL is DESTOM, datafill this refinement.

ACHEAD (continued)**Field descriptions for conditional datafill (Sheet 12 of 17)**

Field	Subfield	Entry	Explanation and action
	IAA_INDEX	0 to 1024	Interadministration accounting index. If the entry in subfield OSEL is IAA, datafill this refinement. Enter the value that indexes the corresponding tuple in table IAACTRL.
	LNET	alphanumeric (1 to 16 characters)	Logical network. If the entry in subfield OSEL is LNET, datafill this refinement. Enter the logical network name that the call is on. The logical network name must be previously datafilled in table LNETWORK. The entry in this field is used by the international metering system to determine a tariff for the call.
	MAX	0 to 30	Maximum digits. If the entry in subfield OSEL is MM, datafill this refinement. Enter the maximum number of digits expected. This value includes the digits used to index the current tuple and must also include the prefix digits specified in the current tuple.
	MIN	0 to 30	Minimum digits. If the entry in subfield OSEL is MM, datafill this refinement. Enter the minimum number of digits expected. This value includes the digits used to index the current tuple and must also include the prefix digits specified in the current tuple.
	MZONE	0 to 63	Metering zone. If the entry in subfield OSEL is MZONE, datafill this refinement. Enter the metering zone of the call, in the logical network as defined by selector LNET. The entry in this field is used by the international metering system to determine a tariff for the call.

ACHEAD (continued)**Field descriptions for conditional datafill (Sheet 13 of 17)**

Field	Subfield	Entry	Explanation and action
	NETSRV_ NAME	IPHS, DPHS, MOBILE, DA, TELEGRAM, or NCC	<p>Network service name. If the entry in subfield OSEL is NETSRV, datafill this refinement. The entry in this field determines the parameters in an outgoing IAM message.</p> <p>Enter IPHS to indicate a call to an independent personal handyphone system subscriber.</p> <p>Enter DPHS to indicate a call to a dependent personal handyphone system subscriber.</p> <p>Enter MOBILE to indicate a call to a mobile subscriber.</p> <p>Enter DA to indicate a call to the directory assistance operator.</p> <p>Enter TELEGRAM to indicate a call to the Telegram office.</p> <p>Enter NCC to indicate a call routed to one of the following networks:</p> <ul style="list-style-type: none"> • New Common Carrier serving international toll traffic • New Common Carrier serving national toll traffic
	NICRF	NICRF	<p>NIC routing function. This option allows transit calls prefixed with the NIC to access table PNINFO to route the call based on the NIC. Note that the NICRF and PNRF options are incompatible and cannot be datafilled on the same tuple.</p>
	NOA	INTL, LOCAL, NATL, or NET	<p>Nature of address. Enter the required called party nature of address as follows:</p> <ul style="list-style-type: none"> • INTL (international) • LOCAL (local) • NATL (national) • NET (Intelligent Network Services)

ACHEAD (continued)**Field descriptions for conditional datafill (Sheet 14 of 17)**

Field	Subfield	Entry	Explanation and action
	ONNET	Y or N	<p>Call on virtual private network. If the entry in subfield OSEL is VPN, datafill this refinement. Enter Y if the call stays within the defined virtual private network. Otherwise, enter N.</p> <p>Overlap outpulsing is supported only on off-network calls. Calls processed without subfield ONNET set to Y are off-network calls. Meridian Digital Centrex (MDC) calls are treated as off-network calls, and therefore overlap outpulsing is supported for MDC calls.</p>
	PCCDR	0 to 9, B, C, D, E (1 to 3 digits)	<p>Pseudo country code digits. If the entry in subfield OSEL is PCC, datafill this refinement. Enter the three-digit pseudo country code (PCC). If a two-digit PCC is required, it must be padded by a leading zero.</p> <p>The pseudo country code is used to record a particular pseudo country code. This can be extracted for use by system logic later, for example, two-stage outpulsing.</p>
	PFDIGS	0 to 24	<p>Number of prefix digits. If the entry in subfield OSEL is PF, datafill this refinement. Enter the number of prefix digits. If prefix digits are identified in a previous table, this number is added to the existing value. Prefix digits are not used to index any further translation tables and are not outpulsed, but they do remain stored in call detail records (CDR).</p> <p>Note: If refinements PF and CONSUME are both datafilled for the same tuple, only the entry for the greater of the two values is processed; the other entry is ignored.</p>
	PFXAMA	0 to 4 digits, or N	<p>Called party number prefix in AMA. If NOA is set to NTL, datafill PFXAMA with 0011.</p> <p>If NOA is set to NATL, datafill PFXAMA with 0.</p> <p>If NOA is set to LOCAL or NET, datafill PFXAMA with N.</p>

ACHEAD (continued)**Field descriptions for conditional datafill (Sheet 15 of 17)**

Field	Subfield	Entry	Explanation and action
	PNRF	PNRFOPTS	Ported number recognitions function. Datafill the PNRFOPTS options vector and the INSNG subfields:
	INSNG	See subfields PREFIX and TRUNK_ACCESS_DIG	
	PREFIX	0 to 11	PREFIX indicates the number of leading digits to be copied from an originator's DN and prefixed to the translating number.
	TRUNK_ACCESS_DIG	0 to 9, or N	TRUNK_ACCESS_DIG enables the specification of a trunk access digit to be prefixed to the translating number after the INSNG_PREFIX function has been completed.
	PORTED	PORTED or blank	Number portability indicator. This entry indicates that the service number for this call has been ported.
	PRIVL	Y or N	Privileged user. If the entry in subfield OSEL is PRIVL, datafill this refinement. Enter Y (yes), if the user is a privileged user (for example, operator). Otherwise, enter N (no).
	SKIPDIGS	0 to 24	Skip digits. If the entry in subfield OSEL is EXTCIC, enter data for this refinement. This field indicates the number of digits to skip before removing the carrier digits from the digit stream. This field operates on the B (called) number, so it is assumed that the system signals the CIC as part of the B number.

ACHEAD (continued)**Field descriptions for conditional datafill (Sheet 16 of 17)**

Field	Subfield	Entry	Explanation and action
	SOURCE	PRESUB or DIALED	<p>Carrier identification code source. If the entry in subfield OSEL is EXTCIC, enter data for this refinement. This field specifies the source of the CIC as follows:</p> <ul style="list-style-type: none"> • PRESUB - presubscribed. Table TRKGRP contains the definition of the CIC. • DIALED - dialed. The subscriber enters the CIC when dialing a call.
	STOPRTMR	Y or N	<p>Stop remote timer. Enter Y to disable the address complete message (ACM) timer of the remote switch. The default value is N.</p>
	XLAID	FREE, GENERIC1, GENERIC2, or GENERIC3	<p>AMA translation identifier. If the entry in subfield OSEL is AMAXLAID, datafill this refinement. Enter the AMA translation identifier to be used against table AMAXLAID.</p>

ACHEAD (continued)**Field descriptions for conditional datafill (Sheet 17 of 17)**

Field	Subfield	Entry	Explanation and action
	XLASYS	AC, AM, CT, FA, FT, NSC, OFC, PX	<p>Translation system. If the entry in subfield OSEL is XLT, datafill this refinement. Enter the next translation system to use, as listed below, followed by a space, then datafill refinement XLANAME:</p> <ul style="list-style-type: none"> • AC (access) • AM (ambiguous) • CT (country) • FA (foreign area) • FT (utility) • NSC (number service code) • OFC (office) • PX (prefix) <p>Note: NIL is not a valid entry. NIL is used only to satisfy internal software functionality. NSC is not used in GL03.</p>
	XLANAME	alphanumeric (1 to 8 characters)	<p>Translation name. If the entry in subfield OSEL is XLT, datafill this refinement. Enter the translation name of the table within the XLASYS to which the call is routed.</p>

ACHEAD (continued)**XLASEL = DBQ**

If the entry in field XLASEL is DBQ, datafill the following refinements.

Field descriptions for conditional datafill (Sheet 1 of 2)

Field	Subfield	Entry	Explanation and action
	OPT	see subfield	Options. This field is a vector consisting of up to ten options. Each option consists of subfield OSEL, and refinements that depend on the entry in subfield OSEL. For each option, specify the option selector (OSEL), followed by a space, then the refinements, each separated by a space. The entry is concluded by a \$ and datafill continues with field DFOP.
	OSEL	MM, NSC, or PF	Option selector. The following options can be selected. Enter MM, followed by a space, and datafill refinements MIN and MAX, if the minimum and maximum dialed digits are known. Enter NSC, followed by a space, and datafill refinement NSCODE, if a number service code operation is to be performed on a call. Enter PF, followed by a space, and datafill refinement PFDIGS if there are prefix digits in the digit stream.
	MAX	0 to 30	Maximum digits. If the entry in subfield OSEL is MM, datafill this refinement. Enter the maximum number of digits expected. This value includes the digits used to index the current tuple and must also include the prefix digits specified in the current tuple.
	MIN	0 to 30	Minimum digits. If the entry in subfield OSEL is MM, datafill this refinement. Enter the minimum number of digits expected. This value includes the digits used to index the current tuple and must also include the prefix digits specified in the current tuple.

ACHEAD (continued)**Field descriptions for conditional datafill (Sheet 2 of 2)**

Field	Subfield	Entry	Explanation and action
	NSCODE	AIN, 800P, E008, E800, MAP_HLR, MAP_MSC, MAP_VLR, PVN, MAPHLR, REPLDIGS, or VPN	<p>Number service code. If the entry in subfield OSEL is NSC, enter the required number service code for the operation to be performed on the call, as listed below:</p> <ul style="list-style-type: none"> • AIN (advanced intelligent network) • 800P (800+) • E008 (Enhanced 008) • E800 (Enhanced 800) • MAP_HLR (mobile application part home location register) • MAP_MSC (mobile application part mobile service switching center) • MAP_VLR (mobile application part visitor location register) • MAPHLR (appears only if the MAP Interworking to BTUP feature is on the switch) • PVN (private virtual network) • REPLDIGS (replace digits) • VPN (virtual private network)
	PFDIGS	0 to 24	<p>Number of prefix digits. If the entry in subfield OSEL is PF, datafill this refinement. Enter the number of prefix digits. If prefix digits are identified in a previous table, this number is added to the existing value. Prefix digits are not used to index any further translation tables and are not outpulsed, but they do remain stored in call detail records (CDR).</p>

ACHEAD (continued)**XLASEL = DMOD**

If the entry in subfield XLASEL is DMOD, datafill the following refinements.

Field descriptions for conditional datafill (Sheet 1 of 8)

Field	Subfield	Entry	Explanation and action
	OPT	see subfield	Options. This field is a vector consisting of up to ten options. Each option consists of subfield OSEL, and refinements that depend on the entry in subfield OSEL. For each option, specify the option selector (OSEL), followed by a space, and the refinements, each separated by a space. The entry is concluded by a \$ and datafill continues with field DFOP.
	OSEL	AFTER, CATRTE, CDNRTE, CGNDM, CONSUME, COODM, CPCRTE, DEL, DESTOM, EXTCIC, INSRT, PF, RBP, REPL, SETCDN, VPNREPL, VPNXLT, or XLT	<p>Option selector. The following options can be selected:</p> <p>Enter AFTER, followed by a space, and datafill refinement AFTER if a specific number of digits must be skipped before modifying the digit stream.</p> <p>Enter CATRTE to allow charge category routing in IBN translations.</p> <p>Enter CDNRTE to route using the called number name (CDNNAME) from table CDNCHAR. If the CDNNAME is present on the incoming call or is set by the SETCDN option, translation proceeds to table CDNUXLA.</p> <p>Enter CGNDM, followed by a space, and datafill refinements PREFXCLI and INSRTCLI to remove digits from the calling line identification (CLI) and insert a datafilled digit string of up to five digits in the prefix string. The total length of the CLI and the digit string can be up to 18 digits. A modified CLI and digit string greater than 18 digits routes the call to treatment.</p> <p>Enter CONSUME, followed by a space, and datafill refinement CONDIGS to specify the number of digits that are consumed during translation.</p>

ACHEAD (continued)**Field descriptions for conditional datafill (Sheet 2 of 8)**

Field	Subfield	Entry	Explanation and action
			<p>Enter COODM, followed by a space, and datafill refinement SERVICE to replace the dialed emergency code by the emergency number stored in table LAC.</p> <p>Note: Option selector COODM must be combined with option XLT to guarantee that translation continues with the modified number. Selector COODM cannot be combined with any other option.</p> <p>Enter CPCRTE to route using the calling party category (CPCNAME) from table CPCCHAR. If the CPCNAME is present on the incoming call, translation proceeds to table CPCUXLA.</p> <p>Enter DEL, followed by a space, and datafill refinement DELDIGS. Further digits are accepted from the agent, and overlap outpulsing is not affected. Digits being deleted are processed before those being inserted.</p> <p>Enter DESTOM in order to associate a destination OM name with a particular destination.</p> <p>Enter EXTCIC, followed by a space, and enter data for refinements CICSIZE, SKIPDIGS, and SOURCE. The EXTCIC subfield is the external carrier identification code that indicates a long distance carrier in the global environment. This option is supported for TOPS calls.</p>

ACHEAD (continued)

Field descriptions for conditional datafill (Sheet 3 of 8)

Field	Subfield	Entry	Explanation and action
			<p>Enter INSRT, followed by a space, and datafill refinement INSRDIGS. Further digits are accepted from the agent, and overlap outputting is not affected. Digits being deleted are processed before those being inserted.</p> <p>Note: Digit insertion is done in the actual digit stream, and the changes are reflected in call detail records. Replacement and insertion cannot be datafilled in the same tuple. If both options are datafilled, the second option in the tuple is used.</p> <p>Enter PF, followed by a space, and datafill refinement PFDIGS, if there are prefix digits in the digit stream.</p> <p>Enter RBP without refinements. The entry RBP is used when a call is to be marked as Ringback Price. The RBP entry in table ACCODE suffixes a hexadecimal E to the calling digits for a call that translates using a tuple with option RBP.</p> <p>Enter REPL and datafill refinement REPLDIGS. Overlap outputting is disabled, and all digits are collected before continuing.</p> <p>Note: Digit replacement occurs in the actual digit stream, and the changes are reflected in call detail records. Replacement and insertion cannot be datafilled in the same tuple. If both options are datafilled, the second option in the tuple is used.</p>

ACHEAD (continued)**Field descriptions for conditional datafill (Sheet 4 of 8)**

Field	Subfield	Entry	Explanation and action
			<p>Enter SETCDN to trigger the setting of outgoing called party characteristics. This option assigns the called number name (CDNNAME) from table CDNCHAR to the call. If the CDNRTE option is subsequently encountered, the CDNNAME is used to route the call.</p> <p>You can use the SETCDN option to allow CDN routing when incoming agents such as DPNSS or BTUP are not available in table CDNCHAR.</p> <p>Enter VPNREPL to replace the called party digits with the VPN called party digits conveyed across the public network by the QSIG Feature Transparency mechanism.</p> <p>Enter VPNXLT to replace the current translation system and translation name with the values stored in table BGIDMAP. The entry to table BGIDMAP is addressed by the NNI BGID and SIGNIFICANCE information received in the originating signaling for the call.</p> <p>Note: The VPNXLT and XLT options must not both exist in the same tuple.</p> <p>Enter XLT, followed by a space, and datafill refinement XLASYS if the call proceeds to another translation system.</p>

ACHEAD (continued)**Field descriptions for conditional datafill (Sheet 5 of 8)**

Field	Subfield	Entry	Explanation and action
	AFTER	0 to 29	<p>After. If the entry in subfield OSEL is AFTER, datafill this refinement. Enter the number of digits to skip before doing the modification. The default case is to calculate the new prefix fence, and replace, insert, or delete digits after the fence (for example, starting at the next digit). Option AFTER is an additional number of digits to skip before doing the modification. Option AFTER refers to the option datafilled immediately before it. For example:</p> <p>>DMOD DEL 3 AFTER 2 INSRT 11</p> <p>skips two digits, deletes the next three, and inserts digits 11 at the beginning of the digit string. The result when applied to 234567 is 23117.</p> <p>Note: Datafilling this refinement with 0 (the default value), displays the following error message:</p> <pre>Too few digits for AFTER UNSUPPORTED OPTION AT: # PROCESSING ERROR UNEXPECTED ERROR CONDITION</pre>
	CATRTE	CATRTE	Enter CATRTE to allow charge category routing in IBN translations.
	CDNNAME	alphanumeric string	Called number name. If the entry in subfield OSEL is SETCDN, enter data for this refinement. Enter data for this refinement to
	CICSIZE	1 to 4	<p>CIC size. If the entry in subfield OSEL is EXTCIC, enter data for this refinement. This field indicates the number of digits in the CIC. This field operates on the B (called) number, so it is assumed that the switch signals the CIC as part of the B number.</p> <p>The MAP display indicates the range is 0 to 4. The system does not allow a 0 entry.</p>

ACHEAD (continued)**Field descriptions for conditional datafill (Sheet 6 of 8)**

Field	Subfield	Entry	Explanation and action
	CONDIGS	numeric (0 to 29 digits)	Consumed digits. If the entry in subfield OSEL is CONSUME, datafill this refinement. Enter a number to explicitly define the number of digits consumed during call processing.
	DELDIGS	0 to 29	Delete digits. If the entry in subfield OSEL is DEL, datafill this refinement. Enter the number of digits to be deleted, after skipping digits to be left unprocessed.
	DESTOM	Destination OM names that are datafilled in table TERMINFO (16 character vector).	Destination and route based OMs. If the entry in subfield OSEL is DESTOM, datafill this refinement.
	INSRDIGS	0 to 29 digits	Insert digits. If the entry in subfield OSEL is INSRT, datafill this refinement. Enter the digits to be inserted, after skipping digits to be left unprocessed.
	INSRTCLI	1 to 5 digits or \$	Insert calling line identification. If the entry in subfield OSEL is CGNDM, datafill this refinement. Enter the new string to insert as the prefix onto the CLI. Enter \$ to specify that no digit string is inserted.
	PFDIGS	0 to 24	Number of prefix digits. If the entry in subfield OSEL is PF, datafill this refinement. Enter the number of prefix digits. If prefix digits are identified in a previous table, this number is added to the existing value. Prefix digits are not used to index any further translation tables and are not outpulsed, but they do remain stored in call detail records (CDR).
			Note: If refinements PF and CONSUME are both datafilled for the same tuple, only the entry for the greater of the two values is processed; the other entry is ignored.

ACHEAD (continued)**Field descriptions for conditional datafill (Sheet 7 of 8)**

Field	Subfield	Entry	Explanation and action
	PREFXCLI	0 to 18	Prefix calling line identification. If the entry in subfield OSEL is CGNDM, datafill this refinement. Enter the number of prefix digits to delete.
	REPLDIGS	numeric (0 to 30 digits)	Replace digits. If the entry in subfield OSEL is REPL, datafill this refinement. Enter the digits that replace the existing digits, after skipping digits to be left unprocessed.
	SERVICE	alphanumeric (1 to 8 characters)	COODM service. If the entry in subfield OSEL is COODM, datafill this refinement. Enter the emergency service name. Emergency service names are listed in field EMRGSERV in table LAC.
	SKIPDIGS	0 to 24	Skip digits. If the entry in subfield OSEL is EXTCIC, enter data for this refinement. This field indicates the number of digits to skip before removing the carrier digits from the digit stream. This field operates on the B (called) number, so it is assumed that the system signals the CIC as part of the B number.
	SOURCE	PRESUB or DIALED	Carrier identification code source. If the entry in subfield OSEL is EXTCIC, enter data for this refinement. This field specifies the source of the CIC as follows: <ul style="list-style-type: none"> • PRESUB - presubscribed. Table TRKGRP contains the definition of the CIC. • DIALED - dialed. The subscriber enters the CIC when dialing a call.

ACHEAD (continued)**Field descriptions for conditional datafill (Sheet 8 of 8)**

Field	Subfield	Entry	Explanation and action
	XLASYS	AC, AM, CT, FA, FT, NSC, OFC, or PX	<p>Translation system. If the entry in subfield OSEL is XLT, datafill this refinement. Enter the next translation system to use, followed by a space, and datafill subfield XLANAME (the instance of the translation system).</p> <p>The choice of translation systems is as follows:</p> <ul style="list-style-type: none"> • AC (access) • AM (ambiguous) • CT (country) • FA (foreign area) • FT (utility) • NSC (number service code) • OFC (office) • PX (prefix) <p>Note: NIL is not a valid entry. NIL is used only to satisfy internal software functionality. NSC is not used in GL03.</p>
	XLANAME	alphanumeric (1 to 8 characters)	<p>Translation name. If the entry in subfield OSEL is XLT, datafill this refinement. Enter the translation name of the table within the XLASYS to which the call is routed.</p>

XLASEL = DNRTE

If the entry in subfield XLASEL is DNRTE, datafill the following refinements. Selector DNRTE allows translation to continue in table DNETINV. Through this translation, calls can be terminated at directory numbers (DN) datafilled in table DNINV.

After datafilling table ACHEAD, table DNINV must be datafilled before selector DNRTE is datafilled in table ACCODE.

ACHEAD (continued)

Table AMAXLAID must be datafilled prior to selecting option AMAXLAID in field OSEL.

Field descriptions for conditional datafill (Sheet 1 of 4)

Field	Subfield	Entry	Explanation and action
	OPT	see subfield	Options. This field is a vector consisting of a maximum of ten options. Each option consists of subfield OSEL, and refinements that depend on the entry in subfield OSEL. For each option, specify the option selector (OSEL), followed by a space, and the refinements, each separated by a space. The entry is concluded by a \$ and datafill continues with field DFOP.
	OSEL	ALLOWOVLP, AMAXLAID, CAMA, CLASS, DN, MM, PF, or SF	<p>Option selector. The following options can be selected.</p> <p>Enter ALLOWOVLP to allow overlap. This subfield does not have refinements.</p> <p>Enter AMAXLAID, followed by a space, and datafill refinement XLAID to specify an automatic message accounting (AMA) identity from within table AMAXLAID.</p> <p>Enter CAMA, followed by a space, and datafill refinement CLDFMT. The entry in CLDFMT indicates whether the international centralized AMA (ICAMA) record is generated with the originally signaled DN or the final public switched telephone network (PSTN) number.</p>

ACHEAD (continued)**Field descriptions for conditional datafill (Sheet 2 of 4)**

Field	Subfield	Entry	Explanation and action
	CLDFMT	CURRENT, POSTXLA	<p>Enter CLASS, followed by a space, and datafill refinement CLASS if the class of the dialed digits is determined.</p> <p>Enter DN, followed by a space, and datafill refinements SNPA and OFC for the DN that the call is routed to.</p> <p>Enter MM, followed by a space, and datafill refinements MIN and MAX if the minimum and maximum dialed digits are known.</p> <p>Enter PF, followed by a space, and datafill refinement PFDIGS if there are prefix digits in the digit stream.</p> <p>Enter SF, followed by a space, and datafill refinement SFDIGS to indicate the beginning of the station code digits.</p> <p>Called format. If the entry in subfield OSEL is CAMA, enter either CURRENT or POSTXLA to produce the required ICAMA record format.</p> <p>If the entry is CURRENT, an ICAMA record is produced with the signaled DN (without translation).</p> <p>If the entry is POSTXLA, an ICAMA record is produced with the public switched telephone network (PSTN) number resulting from translations.</p>

ACHEAD (continued)**Field descriptions for conditional datafill (Sheet 3 of 4)**

Field	Subfield	Entry	Explanation and action
	CLASS	ATT, CNTL, DATT, EMRG, IAGRP, ICNTL, INTL, IOPRA, LCL, NATL, OPRA, RURAL, SPEC, UNKW, or URBAN	<p>Translation class. If the entry in subfield OSEL is CLASS, datafill this refinement. Enter the translation class determined by the dialed digits. This can be used for screening or billing purposes as described under CLASS in screening and charging options.</p> <ul style="list-style-type: none"> • ATT (attendant console) • CNTL (continental) • DATT (dial attendant) • EMRG (emergency) • IAGRP (interagent group) • ICNTL (intercontinental) • INTL (international) • IOPRA (international operator assisted) • LCL (local) • NATL (national) • OPRA (operator assisted) • RURAL (rural) • SPEC (special) • UNKW (unknown) • URBAN (urban)
	MAX	0 to 30	<p>Maximum digits. If the entry in subfield OSEL is MM, datafill this refinement. Enter the maximum number of digits expected. This value includes the digits used to index the current tuple and must also include the prefix digits specified in the current tuple.</p>
	MIN	0 to 30	<p>Minimum digits. If the entry in subfield OSEL is MM, datafill this refinement. Enter the minimum number of digits expected. This value includes the digits used to index the current tuple and must also include the prefix digits specified in the current tuple.</p>

ACHEAD (continued)**Field descriptions for conditional datafill (Sheet 4 of 4)**

Field	Subfield	Entry	Explanation and action
	OFC	numeric (1 to 7 digits)	Seven-digit office code. If the entry in subfield OSEL is DN, enter the office code for the DN that the call is routed to.
	PFDIGS	0 to 24	Number of prefix digits. If the entry in subfield OSEL is PF, datafill this refinement. Enter the number of prefix digits. If prefix digits are identified in a previous table, this number is added to the existing value. Prefix digits are not used to index any further translation tables and are not outpulsed, but they do remain stored in call detail records (CDR).
	SFDIGS	0 to 29	Station fence digits. If the entry in subfield OSEL is SF, datafill this refinement. Enter a number to indicate how many digits to advance past the start of the digits that index into the tuple. During call processing, the station code digits consist of all digits beyond this indicator to the end of the dialed digits. If option SF is not datafilled, the last four digits comprise the station code.
	SNPA	000 to 999 (3 digits)	Serving number plan area. If the entry in subfield OSEL is DN, enter the required serving number plan area (SNPA). This number must be datafilled in table HNPACONT or in table SNPANAME.
	XLAID	FREE, GENERIC1, GENERIC2, or GENERIC3	AMA translation identifier. If the entry in subfield OSEL is AMAXLAID, enter the AMA translation identifier to be used against table AMAXLAID.

ACHEAD (continued)

XLASEL = FEAT

If the entry in field XLASEL is FEAT, datafill the following refinements.

Field descriptions for conditional datafill (Sheet 1 of 3)

Field	Subfield	Entry	Explanation and action
	OPT	see subfield	Options. This field is a vector consisting of up to ten options. Each option consists of subfield OSEL, and refinements that depend on the entry in subfield OSEL. For each option, specify the option selector (OSEL), followed by a space, and the refinements, each separated by a space. The entry is concluded by a \$ and datafill continues with field DFOP.
	OSEL	FTR, FUNC, MM, PF, or XLT	<p>Option selector. The following options can be selected.</p> <p>Enter FTR, followed by a space, and datafill refinement VSC to indicate the international line feature needs translation in table XLA.</p> <p>Enter FUNC, followed by a space, and datafill refinement FUNC to identify the international line feature function.</p> <p>Enter MM, followed by a space, and datafill refinements MIN and MAX if the minimum and maximum dialed digits are known.</p> <p>Enter PF, followed by a space, and datafill refinement PFDIGS if there are prefix digits in the digit stream.</p> <p>Enter XLT, followed by a space, and datafill refinement XLANAME if the translation name of the translation system is known.</p>

ACHEAD (continued)**Field descriptions for conditional datafill (Sheet 2 of 3)**

Field	Subfield	Entry	Explanation and action
	FTR	CALLBACK, CALLCHAR, CLCTDIGS, JES, NTC, VMWI, VSC or VALIDATE	<p>Feature name. If the entry in subfield OSEL is FTR, enter the refinement name shown below:</p> <ul style="list-style-type: none"> • CALLBACK (call back) • CALLCHAR (call characters) • CLCTDIGS (collect digits) • JES (Japan emergency services) • NTC (Notify Time Charges) • TLC (trunk logic circuit) • VMWI (voice mail waiting indication) • VSC (vertical service code) • VALIDATE (not used in GL03)
	FUNC	ACT, DEACT, DELETE, INTER, PROG, or USAGE	<p>Feature function code. If subfield OSEL is set to FUNC, enter one of the international line feature function codes listed below:</p> <ul style="list-style-type: none"> • ACT (activate) • DEACT (deactivate) • DELETE (delete) • INTER (interrogate) • PROG (programming) • USAGE (usage)
	MAX	0 to 30	<p>Maximum digits. If the entry in subfield OSEL is MM, datafill this refinement. Enter the maximum number of digits expected following MIN entry and a space. This value includes the digits used to index the current tuple and must also include the prefix digits specified in the current tuple.</p>

ACHEAD (continued)**Field descriptions for conditional datafill (Sheet 3 of 3)**

Field	Subfield	Entry	Explanation and action
	MIN	0 to 30	Minimum digits. If the entry in subfield OSEL is MM, datafill this refinement. Enter the minimum number of digits expected. This value includes the digits used to index the current tuple and must also include the prefix digits specified in the current tuple.
	PFDIGS	0 to 24	Number of prefix digits. If the entry in subfield OSEL is PF, datafill this refinement. Enter the number of prefix digits. If prefix digits are identified in a previous table, this number is added to the existing value. Prefix digits are not used to index any further translation tables and are not outputted, but they remain stored in call detail records (CDR).

XLASEL = FEATINFO

If the entry in subfield XLASEL is FEATINFO, datafill the following refinements. Selector FEATINFO makes use of table DNSCRN to store information against DNs, which is used during call processing to determine how to proceed with the call. The screening function is triggered by selector FEATINFO in the universal translation tables. The options available with this selector are shown below.

Field descriptions for conditional datafill (Sheet 1 of 9)

Field	Subfield	Entry	Explanation and action
	FTR	CALLBACK, CALLCHAR, CLCTDIGS, JES, NTC, TLC, or VALIDATE	Feature name. Enter CALLBACK to enable originator callback during translations. Datafill subfield CALLBACK_OPTION and its refinements, then datafill subfields PFDIGS, MINDIGS, MAXDIGS, and TABREF. Enter CALLCHAR to modify all signaling characteristics. Datafill subfields CLLCHROP, PFDIGS, MINDIGS, MAXDIGS, and TABREF.

ACHEAD (continued)**Field descriptions for conditional datafill (Sheet 2 of 9)**

Field	Subfield	Entry	Explanation and action
			<p>Enter CLCTDIGS to collect digits from the call originator and add them to the called digits stream for translation. Datafill subfields CLDGMIN, CLDGMAX, CLCTDIGS_OPTION, PFDIGS, MINDIGS, MAXDIGS, and TABREF.</p> <p>Enter JES to activate the Japan Emergency Service feature. Datafill refinements PFDIGS and TABREF.</p> <p>Enter NTC to notify the originating subscriber of applicable time and charges after the call terminates. Datafill subfield SUBOPT_NAME and its refinement, then datafill subfields PFDIGS, MINDIGS, MAXDIGS, and TABREF.</p> <p>Enter TLC to enable the test line call feature, which provides audible ringback tone followed by dial tone after specified durations. Datafill subfields RING_BACK_TONE_DUR, DIAL_TONE_DUR, TLC_PREFIX_DIGS, TLC_NUM_DIGS, and TLC_CHARGE.</p> <p>Enter VALIDATE, and datafill subfield VALADTOP and its refinements. Datafill subfields PFDIGS, MINDIGS, MAXDIGS, and TABREF.</p>
	CALLBACK_OPTION	CLCTDEST or NIL	<p>Callback option. If the entry in field FTR is CALLBACK, datafill this option. Enter CLCTDEST to call back the subscriber and collect destination digits. Datafill subfields CLDGMIN, CLDGMAX, DISC_ANNC_TRK, PROMPT_ANNC_TRK, and SEND_ANM. Otherwise, enter NIL.</p>
	CLDGMIN	1 to 24	<p>Minimum collected digits. Enter the minimum number of digits to be collected and entered into the called digit stream.</p>
	CLDGMAX	1 to 24	<p>Maximum collected digits. Enter maximum number of digits to be collected and written into the called digit stream. The value cannot be less than CLDGMIN.</p>

ACHEAD (continued)**Field descriptions for conditional datafill (Sheet 3 of 9)**

Field	Subfield	Entry	Explanation and action
	DISC_ANNC_TRK	alphanumeric (1 to 16 characters)	Disconnect announcement trunk. Enter trunk common language location identifier (CLLI).
	PROMPT_ANNC_TRK	alphanumeric (1 to 16 characters)	Prompt announcement trunk. Enter trunk the common language location identifier (CLLI).
	SEND_ANM	Y or N	Send answer message. Enter Y (yes) or N (no).
	CLLCHROP	NOCHGMSG or EARLYCPG	Call characteristics. If the entry in field FTR is CALLCHAR, datafill this option. Enter NOCHGMSG to block backward CHG message. Enter EARLYCPG to specify that a call progress (CPG) message is issued in the backwards direction before an address complete message (ACM) is sent. The CPG message is permitted before an ACM in certain ISDN user part (ISUP) variants to establish a bidirectional speech path and to stop the T7 timer.
	CLCTDIGS_OPTION	NIL or \$	Collect digits option. If the entry in field FTR is CLCTDIGS, datafill this option. Enter NIL or enter \$ to proceed to the next option.
	SUBOPT_NAME	DUR_ADJ	Suboption name. If the entry in field FTR is NTC, datafill this option. Enter DUR_ADJ to specify the duration adjustment for NTC and datafill subfield DURATION_ADJ.
	DURATION_ADJ	0 to 99	Duration adjustment. Enter the time in seconds.
	RING_BACK_TONE_DUR	1 to 255	Ringback tone duration. If the entry in field FTR is TLC, datafill this option. Enter the time, in seconds, that ringback tone is provided to the originator.
	DIAL_TONE_DUR	1 to 255	Dial tone duration. If the entry in field FTR is TLC, datafill this option. Enter the time, in seconds, that dial tone is provided to the originator.

ACHEAD (continued)**Field descriptions for conditional datafill (Sheet 4 of 9)**

Field	Subfield	Entry	Explanation and action
	TLC_PREFIX_ DIGS	0 to 18	Prefix digits in called number. If the entry in field FTR is TLC, datafill this option. Enter the number of digits to advance the prefix fence to detect the charge message digits when CPC = PAYPHONE.
	TLC_NUM_ DIGS	numeric (3 or 4) Japan only	Test line call number of digits. Enter the number of dialed digits to be transferred to the NCCI#7 CHG message. This is also the number of digits stored in the LMNNUM field of the SMDR #DE record.
	TLC_CHARGE	Y or N	Test line call charge indicator. The TLC_CHARGE field indicates the billing status of an ISUP test call. Enter Y if the call is billable. Enter N if the call is not billable. The default value for this field is N.
	OPT	see subfield VALDATOP	Options. If the entry in field FTR is VALIDATE, datafill this option. This field is a vector consisting of up to five options. Each option consists of subfield VALDATOP, and refinements that depend on the entry in subfield VALDATOP. For each option, specify VALDATOP, followed by a space, then the refinements, each separated by a space. The entry is concluded by a \$ and datafill continues with field DFOP.
	VALDATOP	BCSCRN, CALLED, CLDTCOLG, CLISERV, CUSTMOD, LCASCRN, NOCHARGE, PRESEL, SCRNLNTH, SUBSCRN, TCNOTSCR, THIRDPTY, VERDEST, V3PTYBIL	Validate option. Enter a list of up to five options. The options specify what characteristics are to be considered when screening the call. Enter \$ to signify the end of the list. Note: Selector VALIDATE is traversed only once for each call. Enter BCSCRN and datafill refinement BCOPTS to identify the bearer capability name.

ACHEAD (continued)**Field descriptions for conditional datafill (Sheet 5 of 9)**

Field	Subfield	Entry	Explanation and action
			<p>Enter CALLED to indicate the number to be used for screening. The SUBSCRN options are used to specify the subscriber types allowed to receive the call.</p> <p>Note: When using option CALLED, there must be no further digit manipulation after selector VALIDATE is encountered in translations.</p> <p>If option CALLED is not entered, then the calling party number is used for screening and the SUBSCRN options are used to specify the subscriber types allowed to make the call.</p> <p>Note: Pay phone subscribers are treated as general subscribers if option CALLED is specified.</p> <p>Enter CLDTCOLG, followed by a space, to copy digits from the called to the calling digit stream, and datafill options OFFSET and COUNT.</p> <p>Enter CLISERV, followed by a space, and enter data for refinement SERVNAME to add the name of the service provider.</p> <p>Enter CUSTMOD, followed by a space, to alter the internal network class of service (NCOS) and customer group to new value for a given directory number (DN) based on the CUSTINFO attribute in table DNSCRN. The source of the DN used as an index into table DNSCRN is determined by the VALIDATE datafill. Datafill refinement CUSTSCRN.</p> <p>Enter LCASCRN, followed by a space, to enable local calling area screening. The called and calling numbers are checked against tables LCARNAME and LCASCRN to determine if the numbers are local to each other, and whether the call should be denied or allowed to continue routing.</p>

ACHEAD (continued)

Field descriptions for conditional datafill (Sheet 6 of 9)

Field	Subfield	Entry	Explanation and action
			<p>Enter NOCHARGE, followed by a space, to indicate that the call is nonbillable.</p> <p>Note: If both NOCHARGE and THIRDPITY options are specified, NOCHARGE takes precedence.</p> <p>Enter PRESEL to allow screening for the PRESEL attribute in table DNSCRN.</p> <p>Enter SCRNLNTH, followed by a space, and datafill refinement MINLNTH to specify the minimum length of the number being screened.</p> <p>Enter SUBSCRN, followed by a space, and datafill up to three multiples of the following subscriber types: GENERAL, PAYPHONE, PERSONAL, and MOBILE. Enter \$ after entering SUBSCRN to indicate that no subscriber types are permitted to make or receive the call.</p> <p>Enter TCNOTSCR to indicate that calls with CPC set to Test Call are not screened.</p> <p>Enter THIRDPITY to indicate that automatic third party billing is used. Table DNSCRN is checked for attribute UNPAID.</p> <p>Note: If both NOCHARGE and THIRDPITY options are specified, NOCHARGE takes precedence.</p> <p>Note: Payphone subscribers are treated as general subscribers if option CALLED is specified.</p> <p>Enter VERDEST to verify the destination of a call. Called digits are checked against ADDCODE entries in table DNSCRN.</p> <p>Note: NIL appears on the switch range but is not a valid entry. The value NIL is used only to satisfy internal software requirements.</p>

ACHEAD (continued)**Field descriptions for conditional datafill (Sheet 7 of 9)**

Field	Subfield	Entry	Explanation and action
	BCOPTS	alphanumeric (1 to 8 characters)	Bearer capability option. If the entry in field VALDATOP is BCSCRN, datafill this refinement. Enter up to four bearer capability names.
	COUNT	0 to 30	If the entry in field VALDATOP is CLDTCCLG, enter subfield COUNT to count the digits from the called stream to the calling stream.
	CUSTSCRN	Y or N	Customer screen. Enter Y to block calls that are not subscribed to the switched on-net services if attempting a switched on-net call. If the DN being screened is not present in table DNSCRN, the call is rejected with the Call Not Allowed (CNAD) treatment. The internal NCOS and CUSTGRP associated with the call are altered to the values found in the CUSTINFO attribute if present for the given DN in table DNSCRN. The DN used to index table DNSCRN can be the subscriber calling line identification (CLI) or the dialed number. The source of the DN is determined by the datafill of field VALIDATE. Enter N if no screening is performed.
Note: The FEATINFO values CCANN, CCARD, CCSDT, DFOP, FAXSUP, FAXTEST, INBFAX, INBFD, INTLFD, ISD, ISDTST, ISDVRE, OUTBFAX, OUTBFD, PB3RDPTY, PBCALL, PBISD, PBISDVRE, and PBTST are valid only in DMS-250 switching offices. Additional DMS-250 parameters are listed in the DMS-250 specific data schema NTPs.			
	MINLNGTH	0 to 18 values from 0 to 30 are possible in APC software loads	Minimum length. If the entry in field VALDATOP is SCRNLNTH, enter the minimum number of digits required in number being screened.
	OFFSET	0 to 30	If the entry in field VALDATOP is CLDTCCLG, enter subfield OFFSET to offset the digits from the called stream to the calling stream.
	SERVNAME	alphanumeric string	Service provider name. If the entry in field VALDATOP is CLISERV, enter the name of the service provider in this refinement.

ACHEAD (continued)**Field descriptions for conditional datafill (Sheet 8 of 9)**

Field	Subfield	Entry	Explanation and action
	SUBSCTYP	GENERAL, PAYPHONE, PERSONAL, or MOBILE	Subscriber type. Enter subscriber type, followed by a space, and datafill refinements WHITLIST, CHKBLKCL, CHKUNPD, and CHKCCR. This option allows you to specify which subscriber types are permitted to make or receive a call and whether the subscriber's standing is important for a call.
	WHITLIST	Y or N	Whether it list. Enter Y (yes) to indicate that the subscriber's directory number must be datafilled in table DNSCRN. Otherwise, enter N (no).
	CHKBLKCL	Y or N	Check block call. Enter Y to check if the subscriber has subscribed to all services for which this tuple is being used (BLKCALL attribute in table DNSCRN). Otherwise, enter N.
	CHKUNPD	Y or N	Check unpaid. Enter Y to check if the subscriber has paid his bills. Otherwise, enter N.
	CHKCCR	Y or N	Check cumulative call restriction. Enter Y to check the subscriber's cumulative charge limit. Otherwise, enter N.
	PFDIGS	0 to 24	Prefix digits. Enter the number of prefix digits present at this point in the call. Prefix digits are not used to index any further translation tables and are not outpulsed, but they remain stored in call detail records (CDR).
	MINDIGS	0 to 30	Minimum digits. Enter the minimum number of digits expected. This value includes the digits used to index the current tuple and must also include the prefix digits specified in the current tuple.
	MAXDIGS	0 to 30	Maximum digits. Enter the maximum number of digits expected. This value includes the digits used to index the current tuple and must also include the prefix digits specified in the current tuple.

ACHEAD (continued)**Field descriptions for conditional datafill (Sheet 9 of 9)**

Field	Subfield	Entry	Explanation and action
	TABREF	see subfields	Table reference. This field consists of subfields XLASYS and XLANAME.
	XLASYS	AC, AM, CT, FA, FT, NSC, OFC, or PX	<p>Translation system. Enter the next translation system to use, followed by a space, and datafill subfield XLANAME (the instance of the translation system).</p> <p>The choice of translation systems is as follows:</p> <ul style="list-style-type: none"> • AC (access) • AM (ambiguous) • CT (country) • FA (foreign area) • FT (utility) • NSC (number service code) • OFC (office) • PX (prefix) <p>Note: NIL is not a valid entry. NIL is used only to satisfy internal software functionality.</p>
	XLANAME	alphanumeric (1 to 8 characters)	Translation name. Enter the translation name of the table instance within the XLASYS to which the call is routed.

ACHEAD (continued)**XLASEL = HRC**

If the entry in subfield XLASEL is HRC, datafill the following refinements.

Field descriptions for conditional datafill (Sheet 1 of 2)

Field	Subfield	Entry	Explanation and action
	OPT	see subfield	Options. This field contains subfield OSEL, and refinements that depend on the entry in subfield OSEL. The entry is concluded by a \$ and datafill continues with field DFOP.
	OSEL	PFBILL, XLT	Option selector. If the call proceeds to another translation system, enter XLT, followed by a space, and datafill refinement XLASYS. Also complete an entry for option selector PFBILL.
	XLASYS	AC, AM, CT, FA, FT, NSC, OFC, PX	<p>Translation system. If option selector XLT is entered in subfield OSEL, datafill this refinement. Enter the next translation system to use, followed by a space, then datafill refinement XLANAME. Enter one of the following:</p> <ul style="list-style-type: none"> • AC (access) • AM (ambiguous) • CT (country) • FA (foreign area) • FT (utility) • NSC (number service code) • OFC (office) • PX (prefix) <p>Note: NIL is not a valid entry. NIL is used only to satisfy internal software functionality. NSC is not used in GL03.</p>

ACHEAD (continued)**Field descriptions for conditional datafill (Sheet 2 of 2)**

Field	Subfield	Entry	Explanation and action
	XLANAME	alphanumeric (1 to 8 characters)	Translation name. If XLT is entered in subfield OSEL, datafill this refinement. Enter the translation name of the table within the XLASYS to which the call is routed.
	PFBILL	Y or N	Prefix billing option. Enter PFBILL, followed by a space, and then enter either Y or N. If "Y" is entered, the home routing code specified in the tuple is included in the billing record. If "N" is entered, the home routing code is not included in billing records.

XLASEL = IAC

If the entry in subfield XLASEL is IAC, datafill the following refinements.

Field descriptions for conditional datafill

Field	Subfield	Entry	Explanation and action
	OPT	see subfield	Options. This field is a vector list consisting of up to ten options. Each option consists of subfield OSEL, and refinements that depend on the entry in subfield OSEL. The entry is concluded by a \$ and datafill continues with field DFOP.
	OSEL	PF	Option selector. Enter PF, followed by a space, and datafill refinement PFDIGS, if there are prefix digits in the digit stream.
	PFDIGS	0 to 24	Number of prefix digits. If the entry in subfield OSEL is PF, datafill this refinement. Enter the number of prefix digits. If prefix digits are identified in a previous table, this number is added to the existing value. Prefix digits are not used to index any further translation tables and are not outputted, but they remain stored in call detail records (CDR).

XLASEL = RTE

If the entry in subfield XLASEL is RTE, datafill the following refinements.

ACHEAD (continued)

Table AMAXLAID must be datafilled prior to selecting option AMAXLAID in field OSEL.

ACHEAD (continued)**Field descriptions for conditional datafill (Sheet 1 of 15)**

Field	Subfield	Entry	Explanation and action
	OPT	see subfield	Options. This field is a vector consisting of a maximum of ten options. Each option consists of subfield OSEL, and refinements that depend on the entry in subfield OSEL. For each option, specify the option selector (OSEL), followed by a space, and the refinements, each separated by a space. The entry is concluded by a \$ and datafill continues with field DFOP.
	OSEL	ACF, AMAXLAID, BLKOVLP, CALLCTRL, CAMA, CATRTE, CDN, CDNRTE, CHGIND, CLASS, CONSUME, CPCRTE, CPMCALL, DDIDX, DEST, DESTOM, DFT EXTCIC, IAA, LNET, MM, MZONE, NETINFO, NETSRV, NICRF, NOANSTIM, NTAIO, NTAIT, PCC, PF, PIP, PNRF, PRESEL, PRESELRTE PRIVL, QFT, SETCDN, TOC, VPN, or VPNPAN	Option selector. Enter ACF, followed by a space, and datafill refinement ACF, if the area code fence is defined. Enter AMAXLAID, followed by a space, and datafill refinement XLAID, to specify an automatic message accounting (AMA) identity from within table AMAXLAID. Enter BLKOVLP to prevent calls from being outpulsed until all CDN digits are collected. This subfield does not have refinements. Enter CALLCTRL, followed by a space, and datafill refinement CALLCTRL. The entry in refinement CALLCTRL indicates who has control of the call: the calling party, the called party, or both.

ACHEAD (continued)**Field descriptions for conditional datafill (Sheet 2 of 15)**

Field	Subfield	Entry	Explanation and action
			<p>Enter CAMA, followed by a space, and datafill refinement CLDFMT. The entry in refinement CLDFMT indicates whether the international centralized automatic message accounting (ICAMA) record is generated with either the originally signaled directory number (DN) or the final public switched telephone network (PSTN) number.</p> <p>Enter CATRTE to allow charge category routing in IBN translations.</p> <p>Enter CDN, followed by a space, and datafill refinement CDN to select the nature of address field. This field is used to identify the called party of the initial address message (IAM). It is used for Australian ISDN user part (AISUP) call translations.</p> <p>Enter CDN RTE to route using the called number name (CDNNAME) from table CDNCHAR. If the CDNNAME is present on the incoming call or is set by the SETCDN option, translation proceeds to table CDNUXLA.</p> <p>CHGIND indicates whether to override the value of the charge indicator in the Backward Call indicators. The CHGIND option applies only to JCTV loads.</p> <p>Enter CLASS, followed by a space, and datafill refinement CLASS, if the class of the dialed digits is determined.</p> <p>Enter CONSUME, followed by a space, and datafill refinement CONDIGS, to specify the number of digits that are consumed during translation.</p> <p>Enter CPC RTE to route using the calling party category (CPCNAME) from table CPCCHAR. If the CPCNAME is present on the incoming call, translation proceeds to table CPCUXLA.</p>

ACHEAD (continued)

Field descriptions for conditional datafill (Sheet 3 of 15)

Field	Subfield	Entry	Explanation and action
			<p>Enter CPMCALL, followed by a space, and datafill refinement CPMCALL, to specify call billing against the called party instead of the calling party for intraoffice calls.</p>
			<p>Enter DDIDX, followed by a space, and enter data for refinement DDIDX. Enter data for this subfield if a destination discount applies to the call.</p>
			<p>Enter DEST, followed by a space, and datafill refinement DEST, the index into the route table of the current XLASYS and XLANAME.</p>
			<p>Enter DESTOM in order to associate a destination OM name with a particular destination.</p>
			<p>Enter DFT for DPNSS feature transparency functionality. Operates in conjunction with the QFT option (see later). QFT must be ON.</p>
			<p>Enter EXTCIC, followed by a space, and enter data for refinements CICSIZE, SKIPDIGS, and SOURCE. This subfield indicates the external carrier identification code.</p>
			<p>Enter IAA and the datafill refinement IAA_INDEX to generate or modify IAA message parameters based on datafill in table IAACtrl.</p>
			<p>Enter LNET, followed by a space, and datafill refinement LNET, the index into table LNETWORK, to find the international metering system tariff for the call.</p>

ACHEAD (continued)

Field descriptions for conditional datafill (Sheet 4 of 15)

Field	Subfield	Entry	Explanation and action
			<p>Enter MM, followed by a space, and datafill refinements MIN and MAX, if the minimum and maximum number of expected digits dialed are known. These values include the digits used to index the current tuple and must also include the prefix digits specified in the current tuple.</p> <p>Note: For fast interdigital timing to function properly, MM can only be used with the RTE selector whenever the value in refinement MIN is not equal to the value in refinement MAX. In other words, if MIN=MAX, MM can be used with the CONT selector in table PXC CODE; if the value in refinement MIN is not equal to the value in refinement MAX, MM cannot be used until the RTE selector is used (which is usually in either table FACODE or table OFCCODE). If refinements MIN and MAX are set in table PXC CODE when they are not equal to each other, partial dial timing is used after MIN digits are dialed in order to determine the end of dialing.</p> <p>Enter MZONE, followed by a space, and datafill refinement MZONE, if metering is done on the call.</p> <p>Enter NETINFO to ensure that the customer group identifier and NCOS are transported to the terminating node to trigger the private IBN translations in a VPN. The private IBN translations are invoked only if options VPNXLT and IBNRX are datafilled at the terminating node.</p> <p>Enter NETSRV and datafill refinement NETSRV_NAME to indicate a Japan network service.</p> <p>Enter NICRF to activate the Network Identification Code (NIC) routing function.</p>

ACHEAD (continued)**Field descriptions for conditional datafill (Sheet 5 of 15)**

Field	Subfield	Entry	Explanation and action
			<p>Enter NOANSTIM to the CONT selectors. This turns the T9 timer off in the outgoing ISUP trunk, if encountered.</p> <p>Enter NTAIO to mark the call destination.</p> <p>Enter NTAIT to mark the call destination.</p> <p>Enter PCC, followed by a space, and datafill refinement PCCDR, if a pseudo country code is required.</p> <p>Enter PF, followed by a space, and datafill refinement PFDIGS, the prefix fence. This is the number of prefix digits associated with this tuple (that is, if some prefix digits were identified in a previous table, the number here is added to the existing value). Prefix digits are not used to index any further translation tables and are not outpulsed, but they remain stored in call detail records (CDR).</p> <p>Enter PIP, followed by a space, to perform a residency check for the digits being translated. The residency check is used by the local number portability feature to ensure that calls to DNs that have been ported into the office are not routed out of the office.</p> <p>Note: You must complete entries in fields MIN and MAX before entering the PIP option.</p> <p>Enter PNRF to invoke the ported number recognition function.</p> <p>Enter PORTED to indicate that a previous node detected the service number of this call to have been ported.</p> <p>Enter PRESEL, followed by a space, and datafill refinement PRESEL to provide the necessary information used to index into table PCIXLA.</p>

ACHEAD (continued)**Field descriptions for conditional datafill (Sheet 6 of 15)**

Field	Subfield	Entry	Explanation and action
			<p>Enter PRESEL RTE for the index into the route table of the current XLASYS and XLANAME. This subfield does not have refinements.</p> <p>Enter PRIVL, followed by a space, and datafill refinement PRIVL, if the user is a privileged user (for example, operators).</p> <p>Enter QFT followed by ON or OFF to indicate if an outgoing route is capable of QSIG Feature Transparency.</p> <p>Note: The QFT ON option must not be added to a route unless the far-end node is QFT-capable.</p> <p>Enter SETCDN to trigger the setting of outgoing called party characteristics. This option assigns the called number name (CDNNAME) from table CDNCHAR to the call. If the CDNRTE option is subsequently encountered, the CDNNAME is used to route the call.</p> <p>You can use the SETCDN option to allow CDN routing when incoming agents such as DPNSS or BTUP are not available in table CDNCHAR.</p> <p>Enter TOC, followed by a space, and datafill refinement CHG for the type of charge where the type of charge messaging is to be selected.</p> <p>Enter VPN, followed by a space, and datafill refinements ONNET and BILLABLE if the call routes through a service switching point (SSP) and the Australian VPN-SSP feature is present in the switch.</p>

ACHEAD (continued)

Field descriptions for conditional datafill (Sheet 7 of 15)

Field	Subfield	Entry	Explanation and action
			Enter VPNPAN to indicate that the PINX is to act as the PAN for an outgoing route. Note: If VPNREPL or VPNXLT have been entered in the DMOD selector, the VPNPAN option is redundant.
	ACF	0 to 29	Area code fence. If the entry in subfield OSEL is ACF, datafill this refinement. Enter the number of digits between the beginning of the digits to currently index the table, and the end of the area code.
	BILLABLE	Y or N	Virtual private network billable call. If the entry in subfield OSEL is VPN, enter Y if an automatic message accounting (AMA) record is required for each VPN call. Otherwise, enter N. An AMA record is not generated if an address complete message (ACM) of address complete, no charge is returned, or if the call terminates in the SSP on a line with the free number terminating (FNT) option.
	CALLCLASS	PRESELEC, CALLTYPE, OVERRIDE, CSN, or TRUNK	Preselection call processing. If the entry in subfield OSEL is PRESEL, datafill this refinement. Enter the preselection call class type that is associated with the call. For charge category routing, enter CALLTYPE. Note: Calltype CSN and TRUNK are available under the PRESEL option. These call classes are not needed for German Carrier Selection, and are not supported. The same applies to the Continue option of CONT. For the German market, only NOCONT is supported.

ACHEAD (continued)**Field descriptions for conditional datafill (Sheet 8 of 15)**

Field	Subfield	Entry	Explanation and action
	CALLCTRL	CALLED, CALLING, LAST, or MUTUAL	<p>Call control. If the entry in subfield OSEL is CALLCTRL, datafill this refinement. Enter one of the following values to specify the party controlling the call:</p> <ul style="list-style-type: none"> • If the entry is CALLED and the called line goes on-hook first, the call is released immediately. If the calling line goes on-hook first and does not reanswer, the connection is not released until the called line goes on-hook. There are no time-outs, and the calling party is allowed to reanswer until the called line goes on-hook. Calls to lines with option ESG must have CALLCTRL(CALLED). Calls terminating on an ITOPS position must have CALLCTRL(CALLED). • If the entry is CALLING and the calling line goes on-hook first, the call is released immediately. If the called line goes on-hook first, the called party is allowed to reanswer within a datafilled reanswer time-out or until the calling line goes on-hook. If the time-out expires or if the calling line goes on-hook, the calling party releases the call and the called line is set to idle. • If the entry is LAST, the call is released when the later of the called party or the calling party goes on-hook. If either party goes on-hook, that party is allowed to reanswer within a datafilled reanswer time-out or until both parties go on-hook. • If the entry is MUTUAL and either line goes on-hook, the call is released immediately.
	CATRTE	CATRTE	Enter CATRTE to allow charge category routing in IBN translations.
	CDNNAME	alphanumeric string	Called number name. If the entry in subfield OSEL is SETCDN, enter data for this refinement to route the call using the called number name from table CDNCHAR.

ACHEAD (continued)**Field descriptions for conditional datafill (Sheet 9 of 15)**

Field	Subfield	Entry	Explanation and action
	CHG	SEND_ CHARGE or SEND_NO_ CHARGE	Charge. If the entry in subfield OSEL is TOC, enter SEND_CHARGE to set the answer message (BTUP ANM) type of answer (TOA) string sent from a node to SEND_CHARGE. Enter SEND_NO_CHARGE to set the answer message (BTUP ANM) type of answer (TOA) string sent from a node to SEND_NO_CHARGE.
	CICSIZE	1 to 4	CIC size. If the entry in subfield OSEL is EXTCIC, enter data for this refinement. This field indicates the number of digits in the CIC. This field operates on the B (called) number, so it is assumed that the switch signals the CIC as part of the B number. The MAP display indicates the range is 0 to 4. The system does not allow a 0 entry.
	CLDFMT	CURRENT or POSTXLA	Called format. If the entry in subfield OSEL is CAMA, enter either CURRENT or POSTXLA to produce the required ICAMA record format. If the entry is CURRENT, an ICAMA record is produced with the signaled DN (without translation). If the entry is POSTXLA, an ICAMA record is produced with a PSTN number resulting from translations.

ACHEAD (continued)**Field descriptions for conditional datafill (Sheet 10 of 15)**

Field	Subfield	Entry	Explanation and action
	CLASS	ATT, CNTL, COLL, DATT, EMRG, IAGRP, ICNTL, INTL, IOPRA, LCL, NATL, OPRA, RURAL, SPEC, UNKW, or URBAN	<p>Translation class. If the entry in subfield OSEL is CLASS, enter the translation class determined by the dialed digits. This can be used for screening or billing as described under CLASS in screening and charging options.</p> <p>The translation classes are defined as follows:</p> <ul style="list-style-type: none"> • ATT (attendant console) • CNTL (continental) • COLL (collect) • DATT (dial attendant) • EMRG (emergency) • IAGRP (interagent group) • ICNTL (intercontinental) • INTL (international) • IOPRA (international operator assisted) • LCL (local) • NATL (national) • OPRA (operator assisted) • RURAL (rural) • SPEC (special) • UNKW (unknown) • URBAN (urban)
	CONDIGS	numeric (0 to 29 digits)	Consumed digits. If the entry in subfield OSEL is CONSUME, datafill this refinement. Enter a number to explicitly define the number of digits consumed during call processing.
	CONTINUE	CONT, NOCONT	Continue. If the entry in subfield OSEL is PRESEL, enter data for this refinement. Enter CONT to continue with the current translations system. Enter NOCONT to stop translations.

ACHEAD (continued)**Field descriptions for conditional datafill (Sheet 11 of 15)**

Field	Subfield	Entry	Explanation and action
	CPMCALL	Y or N	Called party metering. If the entry in subfield OSEL is CPMCALL, enter Y (yes) if calls are billed against the called party for intraoffice calls. Enter N (no) for the default value of billing against the calling party for intraoffice calls.
	DDIDX	1 to 63 or DEFAULT	Destination discount index. If the entry in subfield OSEL is DDIDX, enter data for this refinement to apply the destination discount to the call.
	DEST	0 to 1023	Destination route list index. If the entry in subfield OSEL is DEST, enter the number in the route list, of the same translation system, that the call is routed to.
	DESTOM	Destination OM names that are datafilled in table TERMINFO (16 character vector).	Destination and route based OMs. If the entry in subfield OSEL is DESTOM, datafill this refinement.
	IAA_INDEX	0 to 1024	Interadministration accounting index. If the entry in subfield OSEL is IAA, datafill this refinement. Enter the value that indexes the corresponding tuple in table IAACRL.
	LNET	alphanumeric (1 to 16 characters)	Logical network. If the entry in subfield OSEL is LNET, enter the logical network name that the call is on. The logical network name must be previously datafilled in table LNETWORK. The entry in this field is used by the international metering system to determine a tariff for the call.
	MAX	0 to 30	Maximum digits. If the entry in subfield OSEL is MM, datafill this refinement. Enter the maximum number of digits expected. This value includes the digits used to index the current tuple and must also include the prefix digits specified in the current tuple.

ACHEAD (continued)**Field descriptions for conditional datafill (Sheet 12 of 15)**

Field	Subfield	Entry	Explanation and action
	MIN	0 to 30	Minimum digits. If the entry in subfield OSEL is MM, datafill this refinement. Enter the minimum number of digits expected. This value includes the digits used to index the current tuple and must also include the prefix digits specified in the current tuple.
	MZONE	0 to 63	Metering zone. If the entry in subfield OSEL is MZONE, enter the metering zone of the call, in the logical network as defined by selector LNET. The entry in this field is used by the international metering system to determine a tariff for the call.
	NETSRV_ NAME	IPHS, DPHS, MOBILE, DA, TELEGRAM, or NCC	<p>Network service name. If the entry in subfield OSEL is NETSRV, datafill this refinement. The entry in this field determines the parameters in an outgoing IAM message.</p> <p>Enter IPHS to indicate a call to an independent personal handyphone system subscriber.</p> <p>Enter DPHS to indicate a call to a dependent personal handyphone system subscriber.</p> <p>Enter MOBILE to indicate a call to a mobile subscriber.</p> <p>Enter DA to indicate a call to the directory assistance operator.</p> <p>Enter TELEGRAM to indicate a call to the Telegram office.</p> <p>Enter NCC to indicate a call routed to one of the following networks:</p> <ul style="list-style-type: none"> • New Common Carrier serving international toll traffic • New Common Carrier serving national toll traffic

ACHEAD (continued)**Field descriptions for conditional datafill (Sheet 13 of 15)**

Field	Subfield	Entry	Explanation and action
	NICRF	NICRF	NIC routing function. This option allows transit calls prefixed with the NIC to access table PNINFO to route the call based on the NIC. Note that the NICRF and PNRF options are incompatible and cannot be datafilled on the same tuple.
	NOA	INTL, LOCAL, NATL, or NET	Nature of address. Enter the required called party nature of address. <ul style="list-style-type: none"> • INTL (international) • LOCAL (local) • NATL (national) • NET (Intelligent Network Services)
	ONNET	Y or N	Call on virtual private network. If the entry in subfield OSEL is VPN, enter Y if the call stays within the defined virtual private network. Otherwise, enter N. Overlapped outpulsing is supported only on off-network calls. Calls processed without subfield ONNET set to Y are off-network calls. Meridian Digital Centrex (MDC) calls are treated as off-network calls, and therefore overlapped outpulsing is supported for MDC calls.
	PCCDR	0 to 9, B, C, D, E (1 to 3 digits)	Pseudo country code digits. If the entry in subfield OSEL is PCC, enter the three-digit pseudo country code (PCC). If a two-digit PCC is required, it must be padded by a leading zero. The pseudo country code is used to record a particular pseudo country code. This can be extracted for use by system logic later, for example, two-stage outpulsing.

ACHEAD (continued)

Field descriptions for conditional datafill (Sheet 14 of 15)

Field	Subfield	Entry	Explanation and action
	PFDIGS	0 to 24	Number of prefix digits. If the entry in subfield OSEL is PF, datafill this refinement. Enter the number of prefix digits. If prefix digits are identified in a previous table, this number is added to the existing value. Prefix digits are not used to index any further translation tables and are not outpulsed, but they remain stored in call detail records (CDR). Note: If refinements PF and CONSUME are both datafilled for the same tuple, only the entry for the greater of the two values is processed; the other entry is ignored.
	PFXAMA	0 to 4 digits, or N	Called party number prefix in AMA. If NOA is set to NTL, datafill PFXAMA with 0011. If NOA is set to NATL, datafill PFXAMA with 0. If NOA is set to LOCAL or NET, datafill PFXAMA with N.
	PNRF	PNRFOPTS	Ported number recognitions function. Datafill the PNRFOPTS options vector and the INSNG subfields:
	INSNG	See subfields	
	INSNG_PREFIX IX	0 to 10	INSNG_PREFIX indicates the number of leading digits to be copied from an originator's DN and prefixed to the translating number.
	TRUNK_ACCE SS_DIG	0 to 9, or N	TRUNK_ACCESS_DIG enables the specification of a trunk access digit to be prefixed to the translating number after the INSNG_PREFIX function has been completed.
	PORTED	PORTED or blank	Number portability indicator. This entry indicates that the service number for this call has been ported.
	PRIVL	Y or N	Privileged user. If the entry in subfield OSEL is PRIVL, enter Y (yes), if the user is a privileged user (for example, operator). Otherwise, enter N (no).

ACHEAD (continued)**Field descriptions for conditional datafill (Sheet 15 of 15)**

Field	Subfield	Entry	Explanation and action
	SKIPDIGS	0 to 24	Skip digits. If the entry in subfield OSEL is EXTCIC, enter data for this refinement. This field indicates the number of digits to skip before removing the carrier digits from the digit stream. This field operates on the B (called) number, so it is assumed that the system signals the CIC as part of the B number.
	SOURCE	PRESUB or DIALED	Carrier identification code source. If the entry in subfield OSEL is EXTCIC, enter data for this refinement. This field specifies the source of the CIC as follows: <ul style="list-style-type: none"> • PRESUB - presubscribed. Table TRKGRP contains the definition of the CIC. • DIALED - dialed. The subscriber enters the CIC when dialing a call.
	STOPRTMR	Y or N	Stop remote timer. Enter Y (yes) to disable the address complete message (ACM) timer of the remote switch. The default value is N (no).
	XLAID	FREE, GENERIC1, GENERIC2, or GENERIC3	AMA translation identifier. If the entry in subfield OSEL is AMAXLAID, enter the AMA translation identifier to be used against table AMAXLAID.

XLASEL = TRMT

If the entry in subfield XLASEL is TRMT, datafill the following refinements.

ACHEAD (continued)

Route to the specified treatment. A treatment is a known exception or failure condition. The action taken terminates translation, returning an indication that a treatment was encountered and decoded into a route.

Field descriptions for conditional datafill

Field	Subfield	Entry	Explanation and action
	OPT	see subfield	Options. This field is a vector consisting of up to ten options. Each option consists of subfield OSEL, and refinements that depend on the entry in subfield OSEL. For each option, specify the option selector (OSEL), followed by a space, and the refinements, each separated by a space. The entry is concluded by a \$ and datafill continues with field DFOP.
	OSEL	DESTOM	Enter DESTOM in order to associate a destination OM name with a particular destination.
		OFC	Option selector. Enter OFC, followed by a space, and datafill refinement OFC, if a treatment name is required.
	DESTOM	Destination OM names that are datafilled in table TERMINFO (16 character vector).	Destination and route based OMs. If the entry in subfield OSEL is DESTOM, datafill this refinement.
	OFC	alphanumeric (1 to 4 characters)	Office treatment. Enter a treatment name that is contained in the office treatment subtable, TMTCNTL.TREAT.

XLASEL = all entries

Table AMAXLAID must be datafilled prior to selecting option AMAXLAID in field OSEL.

ACHEAD (continued)

For all entries in subfield XLASEL, datafill the following refinements.

Field descriptions for conditional datafill (Sheet 1 of 15)

Field	Subfield	Entry	Explanation and action
	DFOP	DFOP or NODFOP	<p>Default options. Enter DFOP and datafill subfield OSEL and its refinements.</p> <p>The default options apply only if a tuple with field XLASEL set to RTE or CONT is chosen in the CODE table.</p> <p>If the entry in field DFOP is equal to DFOP, this field is a vector that consists of a number of options. Each option, consisting of subfield OSEL and refinements dependent on the entry in subfield OSEL, is separated from the next by a space. The various refinements are described in subfield OSEL. For each option, specify the option selector, followed by a space, and the refinements, with each refinement separated from the next by a space. The entry is concluded by a \$ and datafill continues with field CON.</p> <p>Enter NODFOP if there are no default options and datafill field CON.</p> <p>In the case of the dialed digits resolving into an RTE or CONT selector, any options not datafilled against the digits can be defaulted to the value specified here. This facility, and option DFLT, are intended to minimize the amount of datafill required in any given CODE table, especially if most of the expected codes have the same attributes. If an option is applicable to most, but not all, tuples in the CODE table instance, the option can still be datafilled in the default options. Options datafilled in the CODE table tuples override the options in the HEAD table, so the different value can be datafilled into those few CODE tuples to which the default option does not apply.</p>

ACHEAD (continued)**Field descriptions for conditional datafill (Sheet 2 of 15)**

Field	Subfield	Entry	Explanation and action
	OSEL	ACF, AMAXLAID, CALLCTRL, CAMA, CDN, CDNRTE, CLASS, CLIOVRD, CONSUME, CPCRTE, CPMCALL, DDIDX, DEST, EXTCIC, IAA, LNET, MM, MZONE, NETSRV, OSS, PCC, PF, PNRF, PRESEL, PRIVL, QFT, SETCDN, TELETAXE, TOC, VPN, or XLT	<p>Option selector. The following options can be selected:</p> <p>Enter ACF, followed by a space, and datafill refinement ACF if the area code fence is defined.</p> <p>Enter AMAXLAID, followed by a space, and datafill refinement XLAID to specify an automatic message accounting (AMA) identity from within table AMAXLAID.</p> <p>Enter CALLCTRL, followed by a space, and datafill refinement CALLCTRL. The entry in refinement CALLCTRL indicates who has control of the call: the calling party, the called party, or both.</p> <p>Enter CAMA, followed by a space, and datafill refinement CLDFMT. The entry in CLDFMT indicates whether the international automatic message accounting (ICAMA) record is generated with the originally signaled directory number (DN) or the final public switched telephone network (PSTN) number.</p> <p>Enter CDN, followed by a space, and datafill refinement CDN to select the nature of address field. This field is used to identify the called party of the initial address message (IAM). It is used for Australian ISDN user part (AISUP) call translations.</p> <p>Enter CDNRTE to route a call using the called number name (CDNNAME) from table CDNCHAR. If the CDNNAME is present on the incoming call or is set by the SETCDN option, translation proceeds to table CDNUXLA. The CDNRTE option does not have refinements.</p> <p>Enter CLASS, followed by a space, and datafill refinement CLASS if the class of the dialed digits can be determined.</p> <p>Enter CLIOVRD, followed by a space, and enter data for refinement CLIOVRD. This subfield indicates calling line identity override.</p>

ACHEAD (continued)

Field descriptions for conditional datafill (Sheet 3 of 15)

Field	Subfield	Entry	Explanation and action
			<p>Enter CONSUME, followed by a space, and datafill refinement CONDIGS to specify the number of digits that are consumed during translation.</p>
			<p>Enter CPCRTE to route the call using the calling party category (CPCNAME) from table CPCCHAR. If the CPCNAME is present on the incoming call, translation proceeds to table CPCUXLA. The CPCRTE option does not have refinements.</p>
			<p>Enter CPMCALL, followed by a space, and datafill refinement CPMCALL to specify call billing against the called party instead of the calling party for intraoffice calls.</p>
			<p>Enter DDIDX, followed by a space, and enter data for refinement DDIDX. This option indicates a destination discount applies to the call.</p>
			<p>Enter DEST, followed by a space, and datafill refinement DEST if the destination is known.</p>
			<p>Enter EXTCIC, followed by a space, and enter data for refinements CICSIZE, SKIPDIGS, and SOURCE. The EXTCIC option indicates the external carrier identification code. This option is supported for TOPS calls.</p>
			<p>Enter IAA, followed by a space, and enter data for refinement IAA_INDEX. The IAA option generates or modifies IAA message parameters based on datafill in table IAACTRL.</p>

ACHEAD (continued)**Field descriptions for conditional datafill (Sheet 4 of 15)**

Field	Subfield	Entry	Explanation and action
			<p>Enter LNET, followed by a space, and enter data for refinement LNET. Enter data for this option if the system requires a logical network for metering.</p> <p>Enter MM, followed by a space, and datafill refinements MIN and MAX if the minimum and maximum dialed digits are known.</p> <p>Enter MZONE, followed by a space, and datafill refinement MZONE if metering is to be done on the call.</p> <p>Enter NETSRV and datafill refinement NETSRV_NAME to indicate a Japan network service.</p> <p>Enter OSS to indicate operator signaling services. This subfield does not have refinements.</p> <p>Enter PCC, followed by a space, and datafill refinement PCCDR if a pseudo country code is required.</p> <p>Enter PF, followed by a space, and datafill refinement PFDIGS if there are prefix digits in the digit stream.</p> <p>Enter PNRF to invoke the ported number recognition function. LNP applications in Germany use the PRNF. The PNRF option does not have refinements.</p> <p>Enter PRESEL, followed by a space, and datafill refinement PRESEL to provide the necessary information used to index into the PCIXLA table.</p> <p>Enter PRIVL, followed by a space, and datafill refinement PRIVL if the user is a privileged user (for example, operators).</p>

ACHEAD (continued)

Field descriptions for conditional datafill (Sheet 5 of 15)

Field	Subfield	Entry	Explanation and action
			<p>Enter QFT followed by ON or OFF to indicate if an outgoing route is capable of QSIG feature transparency.</p> <p>Note: Operating company personnel must not add the QFT ON option to a route unless the far-end node is QFT-capable.</p> <p>Enter SETCDN, followed by a space, and enter data for refinement CDNNAME. The SETCDN option assigns the called number name (CDNNAME) from table CDNCHAR to the call.</p> <p>Enter TELETAXE. This option does not have refinements.</p> <p>Enter TOC, followed by a space, and datafill refinement CHG for the type of charge if the type of charge messaging is selected.</p> <p>Enter VPN, followed by a space, and datafill refinements ONNET and BILLABLE if the call routes through a service switching point (SSP) and the Australian VPN-SSP feature is present in the switch.</p> <p>Enter XLT, followed by a space, and datafill refinement XLASYS if the call is to proceed to another translation system.</p>
	ACF	0 to 29	<p>Area code fence. If the entry in subfield OSEL is ACF, datafill this refinement. Enter the number of digits between the beginning of the digits to currently index the table, and the end of the area code.</p>
	BILLABLE	Y or N	<p>Virtual private network billable call. If the entry in subfield OSEL is VPN, datafill this refinement. Enter Y if an AMA record is required for each VPN call. Otherwise, enter N. An AMA record is not generated if an address complete message (ACM) of address complete, no charge is returned, or if the call terminates in the SSP on a line with the free number terminating (FNT) option.</p>

ACHEAD (continued)

Field descriptions for conditional datafill (Sheet 6 of 15)

Field	Subfield	Entry	Explanation and action
	CALLCLASS	PRESELECT OVERRIDE, CALLTYPE, CSN, or TRUNK	<p>Preselection call processing. If the entry in subfield OSEL is PRESEL, datafill this refinement. Enter the preselection call class type that is associated with the call. For charge category routing, enter CALLTYPE.</p> <p>Note: Calltype CSN and TRUNK are available under the PRESEL option. These call classes are not needed for German Carrier Selection, and are not supported. The same applies to the Continue option of CONT. For the German market, only NOCONT is supported.</p>

ACHEAD (continued)**Field descriptions for conditional datafill (Sheet 7 of 15)**

Field	Subfield	Entry	Explanation and action
	CALLCTRL	CALLED, CALLING, or MUTUAL	<p>Call control. If the entry in subfield OSEL is CALLCTRL, enter one of the following three values to specify the party that has control of the call:</p> <ul style="list-style-type: none"> • If the entry is CALLED and the called line goes on-hook first, the call is released immediately. If the calling line goes on-hook first and does not reanswer, the connection is not released until the called line goes on-hook. There are no time-outs, and the calling party is allowed to reanswer until the called line goes on-hook. <p>Calls to lines with option ESG must have CALLCTRL(CALLED).</p> <p>Calls terminating on an ITOPS position must have CALLCTRL(CALLED).</p> <ul style="list-style-type: none"> • If the entry is CALLING and the calling line goes on-hook first, the call is released immediately. If the called line goes on-hook first, the called party is allowed to reanswer within a datafilled reanswer time-out or until the calling line goes on-hook. If the time-out expires or if the calling line goes on-hook, the calling party releases the call and the called line is set to idle. • If the entry is MUTUAL and either line goes on-hook, the call is released immediately.
	CDNNAME	alphanumeric string	Called number name. If the entry in subfield OSEL is SETCDN, enter data for refinement CDNNAME.

ACHEAD (continued)**Field descriptions for conditional datafill (Sheet 8 of 15)**

Field	Subfield	Entry	Explanation and action
	CHG	SEND_ CHARGE or SEND_NO_ CHARGE	Charge. If the entry in subfield OSEL is TOC, datafill this refinement. Enter SEND_CHARGE to set the answer message (BTUP ANM) type of answer (TOA) string sent out from a node to SEND_CHARGE. Enter SEND_NO_CHARGE to set the answer message (BTUP ANM) type of answer (TOA) string sent out from a node to SEND_NO_CHARGE.
	CICSIZE	1 to 4	CIC size. If the entry in subfield OSEL is EXTCIC, enter data for this refinement. This field indicates the number of digits in the CIC. This field operates on the B (called) number, so it is assumed that the system signals the CIC as part of the B number. The MAP display indicates the range is 0 to 4. The system does not allow an entry of 0.
	CLDFMT	CURRENT or POSTXLA	Called format. If the entry in subfield OSEL is CAMA, enter either CURRENT or POSTXLA to produce the required ICAMA record format. If the entry is CURRENT, an ICAMA record is produced with the signaled DN (without translation). If the entry is POSTXLA, an ICAMA record is produced with public switched telephone network (PSTN) number resulting from translations.

ACHEAD (continued)**Field descriptions for conditional datafill (Sheet 9 of 15)**

Field	Subfield	Entry	Explanation and action
	CLASS	ATT, CNTL, COLL, DATT, EMRG, IAGRP, ICNTL, INTL, IOPRA, LCL, NATL, OPRA, RURAL, SPEC, or UNKW	<p>Translation class. If the entry in subfield OSEL is CLASS, datafill this refinement. Enter the translation class determined by the dialed digits. This can be used for screening or billing purposes as described under CLASS in screening and charging options.</p> <ul style="list-style-type: none"> • ATT (attendant console) • CNTL (continental) • COLL (collect) • DATT (dial attendant) • EMRG (emergency) • IAGRP (interagent group) • ICNTL (intercontinental) • INTL (international) • LCL (local) • IOPRA (international operator assisted) • NATL (national) • OPRA (operator assisted) • RURAL (rural) • SPEC (special) • UNKW (unknown)
	CLIOVRD	CNA, CNB	<p>Calling line identity override. If the entry in subfield OSEL is CLIOVRD, enter data for refinement CLIOVRD. Enter CNA to allow the calling number for each call. Enter CNB to block the calling number for each call.</p>
	CONDIGS	numeric (0 to 29 digits)	<p>Consumed digits. If the entry in subfield OSEL is CONSUME, datafill this refinement. Enter a number to explicitly define the number of digits consumed during call processing.</p>

ACHEAD (continued)**Field descriptions for conditional datafill (Sheet 10 of 15)**

Field	Subfield	Entry	Explanation and action
	CONTINUE	CON or NOCON	<p>Consume digits. The default options apply if a tuple with field XLASEL set to CONT or DMOD is chosen in the CODE tables.</p> <p>The default case is not to consume digits (that is, the next table is indexed using the same digits as the current table, except for ignoring prefix digits). However, under certain conditions, the next table is indexed starting with the digits following the index to the current table (in other words, translations absorb or consume the current index digits). An example of this is when an area code is found in table FACODE. Table OFCCODE is indexed with the digits following the area code (the office code), so the digits used to index table FACODE are consumed. This does not mean that the digits are deleted from the digit register. They remain there and are outpulsed unless explicitly deleted in the CODE or RTE tables. The CON option only means that the digits are not used to index the next table.</p> <p>Enter CON and translation consumes the current index digits, if the next table is indexed starting with the digits following the index to the current table.</p> <p>Enter NOCON if digits are not to be consumed (the next table is indexed using the same digits as the current table, except the prefix digits).</p>
	CPMCALL	Y or N	<p>Called party metering. If the entry in subfield OSEL is CPMCALL, datafill this refinement. Enter Y (yes) if calls are billed against the called party for intraoffice calls. Enter N (no) for the default value of billing against the calling party for intraoffice calls.</p>
	DDIDX	1 to 63 or DEFAULT	<p>Destination discount index. If the entry in subfield OSEL is DDIDX, enter data for this refinement. Enter the destination discount index number.</p>

ACHEAD (continued)**Field descriptions for conditional datafill (Sheet 11 of 15)**

Field	Subfield	Entry	Explanation and action
	DEST	0 to 1023	Destination route list index. If the entry in subfield OSEL is DEST, datafill this refinement. Enter the number in the route list of the translation system that the call is routed to.
	IAA_INDEX	0 to 1024	Interadmission accounting index. If the entry in subfield OSEL is IAA, enter data for this refinement. Enter the value that indexes the corresponding tuple in table IAACTRL.
	LNET	alphanumeric (1 to 8 characters)	Logical network. If the entry in subfield OSEL is LNET, enter data for this refinement. This refinement specifies the name of the logical network that carries the call. Table LNETWORK must already have the logical network. The international metering system uses the entry in this field to determine the tariff for the call.
	MAXIDX	C, F, 9, or STD	<p>Maximum index. Enter C if the translation tables are to be indexed by dialed digits hexadecimal B (*) and hexadecimal C (#) in addition to digits in the range 0 to 9.</p> <p>Enter F if the translation tables are to be indexed by dialed digits in the range 0 to 9, and hex digits B, C, D, E, and F.</p> <p>Enter STD or 9 if the translation tables are to be indexed by dialed digits in the range 0 to 9. The default entry is 9.</p>
	MAX	0 to 30	Maximum digits. If the entry in subfield OSEL is MM, datafill this refinement. Enter the maximum number of digits expected. This value includes the digits used to index the current tuple and must also include the prefix digits specified in the current tuple.
	MIN	0 to 30	Minimum digits. If the entry in subfield OSEL is MM, datafill this refinement. Enter the minimum number of digits expected. This value includes the digits used to index the current tuple and must also include the prefix digits specified in the current tuple.

ACHEAD (continued)**Field descriptions for conditional datafill (Sheet 12 of 15)**

Field	Subfield	Entry	Explanation and action
	MZONE	0 to 63	Metering zone. If the entry in subfield OSEL is MZONE, datafill this refinement. Enter the metering zone of the call, in the logical network as defined by selector LNET. The entry in this field is used by the international metering system to determine a tariff for the call.
	NETSRV_ vvbNAME	IPHS, DPHS, MOBILE, DA, TELEGRAM, or NCC	<p>Network service name. If the entry in subfield OSEL is NETSRV, datafill this refinement. The entry in this field determines the parameters in an outgoing IAM message.</p> <p>Enter IPHS to indicate a call to an independent personal handyphone system subscriber.</p> <p>Enter DPHS to indicate a call to a dependent personal handyphone system subscriber.</p> <p>Enter MOBILE to indicate a call to a mobile subscriber.</p> <p>Enter DA to indicate a call to the directory assistance operator.</p> <p>Enter TELEGRAM to indicate a call to the Telegram office.</p> <p>Enter NCC to indicate a call routed to one of the following networks:</p> <ul style="list-style-type: none"> • New Common Carrier serving international toll traffic • New Common Carrier serving national toll traffic
	NOA	INTL, LOCAL, NATL, or NET	<p>Called nature of address parameter. If the entry in subfield OSEL is CDN, datafill this refinement. Enter the required called party nature of address.</p> <p>If the called party is an international number, enter INTL. If the called party is a local number, enter LOCAL. If the called party is a national number, enter NATL. If the called party subscribes to Intelligent Network Services, enter NET.</p>

ACHEAD (continued)**Field descriptions for conditional datafill (Sheet 13 of 15)**

Field	Subfield	Entry	Explanation and action
	ONNET	Y or N	<p>Call on virtual private network. If the entry in subfield OSEL is VPN, datafill this refinement. Enter Y (yes) if the call stays within the defined virtual private network. Otherwise, enter N (no).</p> <p>Overlapped outpulsing is supported only on off-network calls. Calls processed without the ONNET subfield set to Y are off-network calls. Meridian Digital Centrex (MDC) calls are treated as off-network calls, and therefore overlapped outpulsing is supported for MDC calls.</p>
	PCCDR	0 to 9, B, C, D, E (1 to 3 digits)	<p>Pseudo country code digits. If the entry in subfield OSEL is PCC, datafill this refinement. Enter the three-digit pseudo country code (PCC). If a two-digit PCC is required, it must be padded by a leading zero.</p> <p>The pseudo country code is used to record a particular pseudo country code. This can be extracted for use by system logic later, for example, two-stage outpulsing.</p>
	PFDIGS	0 to 24	<p>Number of prefix digits. If the entry in subfield OSEL is PF, datafill this refinement. Enter the number of prefix digits. If prefix digits are identified in a previous table, this number is added to the existing value. Prefix digits are not used to index any further translation tables and are not outpulsed, but they remain stored in call detail records (CDR).</p> <p>Note: If refinements PF and CONSUME are both datafilled for the same tuple, only the entry for the greater of the two values is processed; the other entry is ignored.</p>
	PFXAMA	0 to 4 digits or N	<p>Called party number prefix in AMA. If NOA is set to NTL, enter 0011 in PFXAMA.</p> <p>If NOA is set to NATL, enter 0 in PFXAMA.</p> <p>If NOA is set to LOCAL or NET, enter N in PFXAMA.</p>

ACHEAD (continued)**Field descriptions for conditional datafill (Sheet 14 of 15)**

Field	Subfield	Entry	Explanation and action
	PRIVL	Y or N	Privileged user. If the entry in subfield OSEL is PRIVL, datafill this refinement. Enter Y (yes), if the user is a privileged user (for example, operator). Otherwise, enter N (no).
	SKIPDIGS	0 to 24	Skip digits. If the entry in subfield OSEL is EXTCIC, enter data for this refinement. This field indicates the number of digits to skip before removing the carrier digits from the digit stream. This field operates on the B (called) number, so it is assumed that the system signals the CIC as part of the B number.
	SOURCE	PRESUB or DIALED	Carrier identification code source. If the entry in subfield OSEL is EXTCIC, enter data for this refinement. This field specifies the source of the CIC as follows: <ul style="list-style-type: none"> • PRESUB - presubscribed. Table TRKGRP defines the CIC. • DIALED - dialed. The subscriber enters the CIC when dialing a call.
	STOPRTMR	Y or N	Stop remote timer. Enter Y (yes) to disable the address complete message (ACM) timer of the remote switch. The default value is N (no).
	XLAID	FREE, GENERIC1, GENERIC2, or GENERIC3	AMA translation identifier. If the entry in subfield OSEL is AMAXLAID, datafill this refinement. Enter the AMA translation identifier to be used against table AMAXLAID.

ACHEAD (continued)**Field descriptions for conditional datafill (Sheet 15 of 15)**

Field	Subfield	Entry	Explanation and action
	XLASYS	AC, AM, CT, DN, FA, FT, NSC, OFC, PX	<p>Translation system. If subfield OSEL is set to XLT, datafill this refinement. Enter the next translation system to use, followed by a space, then datafill refinement XLANAME.</p> <ul style="list-style-type: none"> • AC (access) • AM (ambiguous) • CT (country) • DN (directory number) • FA (foreign area) • FT (utility) • NSC (number service code) • OFC (office) • PX (prefix) <p>Note: NIL is not a valid entry. NIL is used only to satisfy internal software functionality.</p>
	XLANAME	alphanumeric (1 to 8 characters)	<p>Translation name. If the entry in subfield OSEL is XLT, datafill this refinement. Enter the translation name of the table instance within the XLASYS that the call is routed to.</p>

Datafill example

The following example shows sample datafill for table ACHEAD.

Example 1: digits on incoming trunks

The first example shows datafill for a universal translator that is called from incoming trunk groups that have datafill in table TRKGRP, with field XLASEL set to UNIV, field XLASYS set to PX, and field XLANAME set to ICTOLL.

The digits received on the incoming trunks are shown in the following table.

Digits on incoming trunks (Sheet 1 of 2)

Digits received	Explanation
0	Digits starting with 0 are invalid and are blocked
1007	Test call routed to test line TERMARTER

ACHEAD (continued)**Digits on incoming trunks (Sheet 2 of 2)**

Digits received	Explanation
811 + 4 digits, 585 + 4 digits, 586 + 4 digits	Local calls within the area of this switching office with direct trunking
9 + 8 digits	National call, except digits starting with 90 or 91 that are invalid and are blocked
99 + 8 to 12 digits	International call

International calls route to the gateway office on outgoing trunk group with common language location identifier (CLLI) OGTOGATE.

National calls route to a toll office on an outgoing trunk group with CLLI OGTOTOLL.

Local calls route to the switching offices by outgoing trunk groups, OGTO811 and OGTO5856.

The first table to access is the prefix code table with instance ICTOLL.

For digits received on the incoming trunk, translation proceeds as shown in the following table.

Translation of digits on incoming trunks (Sheet 1 of 3)

Digits received	Explanation
0+	INVALID CALLSIn prefix code table, field XLANAME set to ICTOLL, this digit is not found, so the call uses the tuple, in table PXHEAD, DFLT CONT XLT OFC OFC18 to continue translation in table OFCCODE. The digits are not consumed, and the digit 0 (zero) is also not found in table OFCCODE, so it uses table OFCHEAD tuple SDFLT, the standard default that routes the call to vacant code.
1007	TEST LINE CALLIn table PXC CODE, field XLANAME set to ICTOLL, RTE indicates that translation is to be terminated. MM 4 4 indicates that four digits in total are expected. DEST 5 indicates that table PXRTE with CNTOLL 5 gives the route list to use. The route list contains only one member: TERMARTER, the ARTER facility used for network testing in Turkey.

ACHEAD (continued)**Translation of digits on incoming trunks (Sheet 2 of 3)**

Digits received	Explanation
1+	CALL WITHIN SAME AREA. Because this office is in area 1, digit 1 must not be dialed in front of the office code. With the exception of 1007, digit 1 is not found in table PXCODE, field XLANAME set to ICTOLL, and the default routing in table PXHEAD DFLT CONT XLT OFC OFC18 indicates that further translation is required in table OFCCODE. In table OFCCODE, digit 1 is not found, so the call takes the default routing shown in table OFCHEAD, SDFLT, standard default, vacant code treatment.
2+ and 8+	LOCAL CALLS All calls starting with 2 to 8 are found in table PXCODE, field XLANAME set to TOLL CN, and DFLT CONT XLT OFC OFC18 indicates that further translation is required in table OFCCODE. In table OFCCODE, only digits 811, 585, and 586 are found, so any other digits take the default routing shown in table OFCHEAD, SDFLT, standard default, vacant code treatment. For calls starting with 811, DEST 10 indicates table OFCRTE with ICTOLL 10, gives the route list to use. The route list contains one member, OGTO811, two digits are deleted and none are prefixed. For calls starting with 585 or 586, DEST 11 indicates that table OFCRTE with ICTOLL 11, gives the route list to use. The route list contains one member, OGTO5856. No digits are deleted and none are prefixed.
90+ and 91+	INVALID DIGITS. In prefix code table, field XLANAME set to ICTOLL, TRMT OFC VACT indicates that calls starting with these digits are routed to vacant code in table TMCNTL.TREAT.

ACHEAD (continued)**Translation of digits on incoming trunks (Sheet 3 of 3)**

Digits received	Explanation
92+ to 98+	SUBSCRIBER DIALED NATIONAL CALL. In prefix code table, field XLANAME set to ICTOLL, PF 1 indicates the presence of one prefix digit. CONT...XLT FA ICTOLL indicates that further translation is required, using table FACODE instance ICTOLL. The digits 92 to 98 are not consumed, but because of the PF option, the next table is indexed by the digits following 9. In table FACODE, if the digits following the 9 are 2 to 8, the call is routed to DEST 10 in table FARTE that is a route list with one member, trunk group OGTOTOLL. These are long distance calls to other cities. To simplify matters, the digits 2 to 8 are shown in one tuple, but can be expanded to show each area code to eliminate the transmitting of invalid numbers to the toll center.
99+	SUBSCRIBER DIALED INTERNATIONAL PREFIX. In table PXCOD, field XLANAME set to ICTOLL, PF 2 indicates the presence of two prefix digits. CONT...XLT CT CC indicates that further translation is required, using table CTCODE instance CC. The digits 99 are not consumed, but because of the PF option, the next table is indexed by the digits following 99. MM 8 12 indicates that 8 to 12 digits are expected. In table CTCODE, where the digits following 99 are 1 to 9, the call is routed to DEST 12 in table CTRTE, which in turn sends the call on trunk group OGTOGATE to the DMS-300 gateway office. Whether the country code received by the DMS-300 gateway office is valid or not is determined in the gateway office. With additional datafill, it can be determined in this office by entering all the country codes in table CTCODE. If 0 (zero) is the next digit following 99, the call is routed to the standard default, VACANT CODE.

Datafill examples for example 1 The various translation tables used in example 1 are shown in the following.

ACHEAD (continued)

MAP display example for table PXHEAD

XLANAME						DFLT
						DFOP
CON	MAXIDX					
<hr/>						
ICTOLL						
DFLT	CONT	XLT	OFC	OFC18	\$	
						NODFOP
NOCON	9					

MAP display example for table PXCODE

XLANAME	FROMD	TOD	XLADATA
<hr/>			
ICTOLL	1007	1007	
RTE (DEST 5)	(MM 4 4)	\$	
ICTOLL	2	8	
CONT (XLT OFC OFC18)	(MM 7 7)	\$	
ICTOLL	90	90	
TRMT (OFC VACT)	\$		
ICTOLL	91	91	
TRMT (OFC VACT)	\$		
ICTOLL	92	98	
CONT (PF 1) (XLT FA ICTOLL)	(MM 8 8)	\$	
ICTOLL	99	99	
CONT (PF 2) (XLT CT CC)	(MM 8 12)	\$	

MAP display example for table PXRTE

XLANAME	RTEREF			RTELIST
<hr/>				
ICTOLL	5		(S	TERMARTER) \$

ACHEAD (continued)**MAP display example for table CTHEAD**

XLANAME		DFLT
CON	MAXIDX	DFOP
<hr/>		
CC		SDFLT
		NODFOP
NOCON	9	

MAP display example for table CTCODE

XLANAME	FROMD	TOD	XLADATA
<hr/>			
CC	1	9	
RTE (DEST 12) \$			

MAP display example for table CTRTE

XLANAME	RTEREF	RTELIST
<hr/>		
CC	12	(S OGTOGATE) \$

ACHEAD (continued)

MAP display example for table FAHEAD

XLANAME			DFLT
			DFOP
CON	MAXIDX		
<hr/>			
ICTOLL			SDFLT
			NODFOP
CON	9		

MAP display example for table FACODE

XLANAME	FROMD	TOD	XLADATA
<hr/>			
ICTOLL	2	8	
RTE (DEST 10)	\$		

MAP display example for table FARTE

XLANAME	RTEREF		RTELIST
<hr/>			
ICTOLL	10		
		(S	OGTOTOLL) \$

ACHEAD (continued)**MAP display example for table OFCHEAD**

XLANAME	CON	MAXIDX	DFLT	DFOP
OFC18			SLDFLT	NODFOP
CON	9			

MAP display example for table OFCCODE

XLANAME	FROMD	TOD	XLADATA
OFC18	811	811	
RTE (DEST 10)	\$		
OFC18	585	586	
RTE (DEST 11)	\$		

MAP display example for table OFCRTE

XLANAME	RTEREF	RTELIST
OFC18	10	(N OGTO811 NOMOD 2 N) \$
OFC18	11	(S OGTO5856) \$

Example 2: routing of repair service calls

The second example provides access to a repair service. Subscribers dial 02 to report problems on the lines. During the hours 8:30 a.m. to 5:30 p.m., the calls terminate on a line in the same office. At other times, calls are automatically routed to a tandem office with digits 02 outputted.

The international translation tables provide time-of-day routing, and can specify retranslation with a new number from the route list. This redefines certain routes to a new destination.

ACHEAD (continued)

This example shows the routing of repair service calls differently after business hours, using the conditional time-of-day selector (CND) and the retranslate selector (RT).

- A subscriber dials 02 over a line defined with XLASYS XLANAME as PX P613.
- Translations starts with table PXC CODE.
- The TO and FROM digits in table PXC CODE determine that a route can be found at destination 8 of table PXRTE.
- Passage through the route list encounters a conditional selector.
- CONDTYPE TOD causes the time-of-day system to be referenced.
- To calculate the time span, a time stamp is taken and identified as either time 1 (8:30 a.m. to 5:30 p.m. on weekdays) or time 0 (any other time during the week and all weekend), as defined through field TOD in table TIMEODAY.
- Time is compared with field TIMES of the conditional selector.
- If current time is 1, the condition is true. The translation system is instructed to carry on with the route list in table PXRTE at tuple P613 11.
- The route list indicates that retranslation must be done with a new number starting at table PXC CODE, index P613. Using the new number, the TO and FROM digits indicate that translations continue in table DNCODE (for directory numbers) at index D726.
- Searching table DNCODE with the remaining four digits, termination is found on a line. The call attempts to connect to that line.
- If the current time was 0 (false returned), translation continues on the rest of the current route list. This means the routes of tandem1 to tandem3 are tried.

Datafill examples for example 2 The following example is one method that datafill is used to implement the repair feature. The first four tables are a few of the tables unique to the time-of-day routing system that are suitable for this example. Table DAYOYEAR is available for specifying holidays (not shown in this example). The last three tables are some of the tables in the international system that can be used.

ACHEAD (continued)

MAP display example for table DAYTYPES

DAYTYPE
WEEKDAY
WEEKEND

MAP display example for table TODHEAD

TODNAME	TODTYPE	DAYTYPES
REPAIR	RTE 1	(WEEKDAY) (WEEKEND) \$

MAP display example for table DAYOWEEK

TODNAME	WEEKDAY	DAYTYPE
REPAIR	MON	WEEKDAY
REPAIR	TUE	WEEKDAY
REPAIR	WED	WEEKDAY
REPAIR	THU	WEEKDAY
REPAIR	FRI	WEEKDAY
REPAIR	SAT	WEEKEND
REPAIR	SUN	WEEKEND

ACHEAD (continued)**MAP display example for table TIMEODAY**

TODNAME	DAYTYPE	TIME		DATA
REPAIR	WEEKDAY	0 0	RTE	1
REPAIR	WEEKDAY	8 30	RTE	2
REPAIR	WEEKDAY	17 30	RTE	1
REPAIR	WEEKEND	0 0	RTE	1

MAP display example for table PXCOD

XLANAME	FROMD	TOD	XLADATA
P613	02	02	
RTE (MM 2 2) (DEST 8) \$			
P613	726	726	
CONT (XLT DN D726) \$			

MAP display example for table PXRTE

XLANAME	RTEREF		RTELIST
P613	8		
(CDN TOD REPAIR	1	ST 11) (S	TANDEM1)
(S		TANDEM2) (S	TANDEM3) \$
P613	11		
		(RT 7261234 PX	P613) \$

MAP display example for table DNCODE

XLANAME	DNNO	DNTDATA
D726	1234	LINE (LEN 00 1 04 06) \$

ACHEAD (continued)**Example 3: destination checking in tables FTHEAD and FTCODE**

The third example shows tables FTHEAD and FTCODE used for datafilling restricted call diversion (features CDO, CDA, and CDS defined in table LENFEAT). Office parameter CDS_DN_CHECK in table OFCVAR specifies an instance of table FTCODE used to screen the CDS destinations.

Destinations that are not admissible are datafilled into this table. An attempt to program a call diversion to a destination datafilled in table FTHEAD results in failure. In the case of subscriber programming, a NACK treatment is given.

Datafill examples for example 3 In the example, attempting to program call diversion to a DN and using a destination of 58123 fails. Also, special service calls starting with 11 cannot be diverted.

MAP display example for table FTHEAD

XLANAME		DFLT
CON	MAXIDX	DFOP
<hr/>		
CDSCHK		
DFLT	RTE	\$
		NODFOP
NOCON	9	

MAP display example for table FTCODE

XLANAME	FROMD	TOD	XLADATA
<hr/>			
CDSCHK	11	11	
TRMT	\$		
CDSCHK	58	58	
TRMT	\$		
CDSCHK	2250	2250	
TRMT	\$		

Example 4: datafilling subscriber procedures in tables ACHEAD and ACCODE

The fourth example shows possible datafill required in tables ACHEAD and ACCODE to specify the call diversion service codes and dialing sequences.

ACHEAD (continued)

Datafill examples for example 4 Codes defined by the Conference of European Postal and Telecommunications (CEPT) administrations are used in this example: 21 for CDS, 23 for CDO, and 20 for CDA are used for this example.

MAP display example for table ACHEAD

XLANAME		DFLT
CON	MAXIDX	DFOP
<hr/>		
FTRXLA		SDFLT
NOCON	B	NODFOP

MAP display example for table ACCODE

XLANAME	FROMD	TOD	XLADATA
FTRXLA	B21	B21	
FEAT (FTR CDS)	(FUNC ACT)	(PF 3)	\$
FTRXLA	C21	C21	
FEAT (FTR CDS)	(FUNC DEACT)	(PF 3)	\$
FTRXLA	BC21	BC21	
FEAT (FTR CDS)	(FUNC INTER)	(PF 4)	\$
FTRXLA	B23	B23	
FEAT (FTR CDO)	(FUNC ACT)	(PF 3)	\$
FTRXLA	C23	C23	
FEAT (FTR CDO)	(FUNC DEACT)	(PF 3)	\$
FTRXLA	BC23	BC23	
FEAT (FTR CDO)	(FUNC INTER)	(PF 4)	\$
FTRXLA	B20	B20	
FEAT (FTR CDA)	(FUNC ACT)	(PF 3)	\$
FTRXLA	C20	C20	
FEAT (FTR CDA)	(FUNC DEACT)	(PF 3)	\$
FTRXLA	BC20	BC20	
FEAT (FTR CDA)	(FUNC INTER)	(PF 4)	\$

ACHEAD (continued)

Example 5: datafilling announcements in tables FTHEAD, FTCODE, and FTRTE

Office parameter CDIV_SDN_XLA specifies a translation system and instance for translation of the announcement choice. Table FTCODE is recommended for this datafill.

Datafill examples for example 5 An example of datafill for table FTHEAD, FTCODE, and FTRTE is shown below.

MAP display example for table FTHEAD

XLANAME		DFLT
		DFOP
CON	MAXIDX	
<hr/>		
CDXLA		SDFLT
		NODFOP
NOCON	9	

MAP display example for table FTCODE

XLANAME	FROMD	TOD	XLADATA
<hr/>			
CDXLA	12	12	
RTE (DEST 1) \$			
CDXLA	13	13	
RTE (DEST 2) \$			
CDXLA	13	13	
RTE (DEST 3) \$			

ACHEAD (continued)

MAP display example for table FTRTE

XLANAME	RTEREF		RTELIST
CDXLA	1	(S	ANN12) \$
CDXLA	1	(S	ANN13) \$
CDXLA	1	(S	ANN14) \$

The valid announcement choices are datafilled as two-digit entries in table FTCCODE. The example shows entries for 12, 13, and 14. These codes translate to announcements within the office.

If an activation is attempted (either from the subscriber set or from the MAP), the announcement choice must be datafilled in the above table, before the activation is accepted.

Example 6: default tuples for feature WLN in table ACCODE

The sixth example shows the default tuples datafilled at load-build time for entry WLN (Warm Line) in table ACCODE.

Datafill example for example 6 The CEPT-recommended code for WLN is 53. The operating company can use another two-digit numeric code.

MAP display example for table PXCOD

XLANAME	FROMD	TOD	XLADATA
ACCXLA	B53	B53	
FEAT (FTR WLN)	(FUNC ACT)	(PF 3)	\$
ACCXLA	C53	C53	
FEAT (FTR WLN)	(FUNC DEACT)	(PF 3)	\$
ACCXLA	BC53	BC53	
FEAT (FTR WLN)	(FUNC INTER)	(PF 4)	\$

ACHEAD (continued)**Example 7: international line features CCW and INDC**

The seventh example shows datafill for the following international line features:

- CCW (Cancel Call Waiting)
- INDC (International Double Connect)

Refer to table FEATCHG for a brief description of international line features.

MAP display example for table ACCODE

XLANAME	FROMD	TOD	XLADATA
FTRXLA	B36	B36	
FEAT (FTR CCW)	(PF 3)	(FUNC ACT)	\$
FTRXLA	B35	B35	
FEAT (FTR INDC)	(PF 3)	(FUNC ACT)	\$
FTRXLA	C35	C35	
FEAT (FTR INDC)	(PF 3)	(FUNC DEACT)	\$
FTRXLA	BC35	BC35	
FEAT (FTR INDC)	(PF 4)	(FUNC INTER)	\$

Example 8: international line features CDB, CDF, and IDND

The eighth example shows datafill for the following international line features:

- CDB (Call Diversion on Busy)
- CDF (Call Diversion Fixed)
- IDND (International Do Not Disturb)

Refer to table FEATCHG for a brief description of international line features.

ACHEAD (continued)**MAP display example for table ACCODE**

XLANAME	FROMD	TOD	XLADATA
ACCXLA	B60	B60	
FEAT (FTR CDB)	(FUNC ACT)	(PF 3)	\$
ACCXLA	C60	C60	
FEAT (FTR CDB)	(FUNC DEACT)	(PF 3)	\$
ACCXLA	BC60	BC60	
FEAT (FTR CDB)	(FUNC INTER)	(PF 4)	\$
ACCXLA	B27	B27	
FEAT (FTR CDF)	(FUNC ACT)	(PF 3)	\$
ACCXLA	C27	C27	
FEAT (FTR CDF)	(FUNC DEACT)	(PF 3)	\$
ACCXLA	BC27	BC27	
FEAT (FTR CDF)	(FUNC INTER)	(PF 4)	\$
ACCXLA	B26	B26	
FEAT (FTR IDND)	(FUNC ACT)	(PF 3)	\$
ACCXLA	C26	C26	
FEAT (FTR IDND)	(FUNC DEACT)	(PF 3)	\$
ACCXLA	BC26	BC26	
FEAT (FTR IDND)	(FUNC INTER)	(PF 4)	\$

Example 9: Faultsman's Digit Tests (FDT)

Feature FDT enables a field engineer to test a telephone from the subscriber's premises. It complements the existing support for direct maintenance (no operator intervention) provided by field engineer's ringback.

The test operates in two stages:

1. Digit reception test (DRT): The integrity of digit reception is tested by dialing all digits on a push-button telephone or 0 (zero) on a rotary dial telephone. On a digit-pulse (DP) set, this test ensures that the make and break mechanisms are working. For dual-tone multifrequency (DTMF) sets, the test verifies that each digit can break dial tone. Jamming of push-buttons is also detected by DRT.
2. Directory number check (DNC): The intended directory number (DN) is dialed and checked against the value datafilled for that line. This test verifies the datafill.

Once datafilled, this feature is accessible from all lines connected to the switch, on the host and remotes for DP and DTMF telephones.

ACHEAD (continued)

Translations must be datafilled to enable termination with the feature. This is achieved by using the FEAT selector in one of the universal code translation tables.

Datafill examples for example 9 Setting the access code to 111 gives the field engineer the best chance of testing whether the telephone is faulty. A 1 requires the fewest pulses on a DP set, while using the same digit decreases the likelihood of having to use a bad key on a push-button set.

MAP display example for table PXHEAD

XLANAME		DFLT
		DFOP
CON	MAXIDX	

LOCAL8		
DFLT TRMT (OFC VACT) \$		
		NODFOP
NOCON	9	

MAP display example for table ACCODE

XLANAME	FROMD	TOD	XLADATA

LOCAL8	111	111	
FEAT (FTR FDT) \$			

Example 9: Station ringer test (SRT)

The ninth example describes the two methods used to access the station ringer test (SRT). The SRT tests that the directory number (DN) is correct and the ringer at the customer site is in service. Operating company personnel can perform the SRT at the customer site. The operating company can change the access code by changing the datafill options.

Method one uses an access code and the last five digits of the DN. Method one does not work if two DNs in the same office have the same last five digits. If two DNs share the same last five digits, use method two. Method two uses a three-digit access code and a seven- or ten-digit DN. Both methods work if DNs do not share the same last five digits on the same switch.

ACHEAD (continued)

Method one For method one, dial a two-digit access code and the last five digits of the DN. For example, the DN to test is 613-621-1234. Method one can use access code 57. The operating company personnel dial 571-1234 to activate the SRT on the DN.

Method two For method two, dial a three-digit access code and the seven digit DN. Or dial the three-digit access code, the three-digit numbering plan area (NPA), and the seven-digit DN. The three-digit NPA and the seven-digit DN make a ten-digit DN.

Use the ten-digit DN with the access code if a switch supports two DNs that are the same except for the NPA. If this condition occurs, the SRTs compare the number dialed against the station dialing, including the NPA.

Operating companies use different datafill options to accept one of the following dialing options:

- access code plus seven- or ten-digit DN
- access code plus seven-digit DN only
- access code plus ten-digit DN only

If the operating company selects the first option and the subscriber dials seven digits, a pause of several seconds occurs. After the pause, the system processes the call. The pause occurs because the line module (LM) waits to make sure that the subscriber does not dial additional digits.

For example, the DN to test is 613-621-1234. Method two uses code 999. The operating company personnel dials either 999-621-1234 or 999-613-621-1234 to activate the SRT.

If the switch supports another DN, 819-621-1234, the operating company personnel must dial 999-613-621-1234 to activate the SRT. If the operating company personnel use the seven-digit DN with the three-digit access code, both 613-621-1234 and 819-621-1234 DNs will ring.

Example 10: Wake-up Call (WUC)

The tenth example shows datafill in table ACCODE for the Wake-up Call feature (WUC).

ACHEAD (continued)**MAP display example for table ACCODE**

XLANAME	FROMD	TOD	XLADATA
FTRXLA	B55	B55	
FEAT (FTR WUC)	(PF 3)	(FUNC ACT)	\$
FTRXLA	C55	C55	
FEAT (FTR WUC)	(PF 3)	(FUNC DEACT)	\$
FTRXLA	BC55	BC55	
FEAT (FTR WUC)	(PF 4)	(FUNC INTER)	\$

Example 11: International Ring Again (RAG)

The eleventh examples shows datafill in table ACCODE for the International Ring Again (RAG) feature.

MAP display example for table ACCODE

XLANAME	FROMD	TOD	XLADATA
FTRXLA	B37	B37	
FEAT (FTR RAG)	(FUNC ACT)	(PF 3)	\$
FTRXLA	C37	C37	
FEAT (FTR RAG)	(FUNC DEACT)	(PF 3)	\$
FTRXLA	BC37	BC37	
FEAT (FTR RAG)	(FUNC INTER)	(PF 4)	\$

Example 12: Silent Switchman (SSM)

The twelfth example shows datafill in table ACCODE for the Silent Switchman (SSM) feature.

MAP display example for table ACCODE

XLANAME	FROMD	TOD	XLADATA
FTRXLA	117	117	
FEAT (FTR SSM)			\$

ACHEAD (continued)

Table history

MMP15

Added option DESTOM to selectors RTE, TRMT, CONT and DMOD for activity 59026196.

Added options NTAIO and NTAIT to selectors CONT and RTE for activity 59022245.

Added option NETINFO to selectors CONT and RTE for activity 59023093.

MMP14

Corrected text which exceeded table bottom boundary in translation tables for CONT and RTE. Corrected weight of table line rulings and double spaces in text throughout.

Added option DFT to selectors CONT and RTE. (Activity 59016980)

Added option CALLDUR to selector OSEL.

MMP13

Added options PORTED, NICRF and, suboption INSNNG (to PNRF) to selectors CONT and RTE.

Added CATRTE option within OSEL under CONT, DMOD, and RTE selectors.

Added CALLTYPE option under PRESEL.

MMP12

Added option NOANSTIM to selectors CONT and RTE.

EUR010

Added option CPCRTE to selectors CONT, DMOD, and RTE.

APC010

Added field TLC_CHARGE to option TLC in the FEATINFO selector.

APC009.1

Added station ringer test (SRT) information.

APC009

Added option NETSRV to selectors CONT and RTE.

Added option JES to selector FEATINFO.

ACHEAD (continued)

EUR009

Added option BLKOVLP to selector RTE.

EUR008

Added the CDNRTE, SETCDN, VPNREPL, and VPNXLT options within the DMOD selector.

Added the CDNRTE, QFT ON, QFT OFF, SETCDN, and VPNPAN options within the CONT and RTE selectors.

GL04

Added field DFLT.

Added the following options to selectors CONT and RTE:

- CHGIND
- FLEXCHG
- ISUPPREF

Note: The FLEXCHG and ISUPPREF indicators are obsolete, and have been removed from the tables.

APC008.1

The following updates were introduced in APC008.1 to table ACHEAD:

- Field CHKCCR was added to all subscriber types (SUBSCTYP) that are part of the SUBSCRN option of selector FEATINFO VALIDATE.
- Field EARLYCPG was added to selector FEATINFO.
- Option IAA was added to the CONT and RTE selectors.

EUR006

Added PRESEL option to the CONT and RTE selectors.

GL03

The following updates were introduced in GL03:

- Added ACF in CONT and RTE selectors.
- Added CAMA in CONT, DNRTE, and RTE selectors.
- Added HRC selector and PIP option within the RTE selector.
- Added URBAN to selector CLASS.

TL06

Added route selector SX.

ACHEAD (end)

APC006

PERSONAL subscriber type added to SUBSCRN option of FEATINFO VALIDATE.

NA005

Increased the number for universal support to 30 digits, affecting the following options, subfields, or selectors:

- ACF
- AFTER
- CONSUME
- DEL
- DMOD
- DNRTE
- INSRT
- MAX
- MIN
- PF
- REPL

Added option SF and its refinement SFDIGS to selector DNRTE.

Added note about potential conflict with refinements CONSUME and PFDIGS.

Corrected the prefix digits (PF) field description.

APC04

Subfield CDN of selectors CONT and RTE modified to incorporate subfields NOA, STOPRTMR, and PFXAMA.

BCS35

The following items were added:

- options CGNDM and CONSUME to subfield OSEL
- option BCSCRN to field VALDATOP
- general note on restrictions on use of value VALIDATE
- refinement CPMCALL to XLASEL selectors CONT and RTE

ACLANG

Table name

Attendant Console Display Language Table

Functional description

Available languages are specified in table ACLANG. The key to the table is a language name. English appears as the first language and cannot be deleted or changed. Up to seven additional languages can be added to this table by Nortel personnel. The flexible language feature displays the available languages by name on the console exactly as they appear in table ACLANG.

Datafill sequence and implications

There is no requirement to datafill other tables prior to table ACLANG.

Table size

Memory is automatically allocated for a minimum of one entry, which is present before the table is datafilled, and a maximum of eight entries.

Datafill

The following table lists datafill for table ACLANG.

Field descriptions

Field	Subfield or refinement	Entry	Explanation and action
LANGUAGE		alphabetic (maximum 16 characters)	<i>Language</i> Enter the language name. Up to eight different language names are possible. The first tuple of the table is the language ENGLISH.

Datafill example

The following example shows sample datafill for table ACLANG.

ACLANG (continued)

MAP display example for table ACLANG

LANGUAGE
ENGLISH

Supplementary information

This section provides information on datafilling table ACLANG for specific applications, and product information pertaining to table ACLANG.

The attendant receives messages on the alphanumeric display in response to call processing and feature processing events. These are system-defined English messages.

The flexible display language feature provides the ability to datafill equivalent messages for English messages in other languages. The attendant has a standard operating language assigned to it through an option in table ATTCONS. The operating language of attendant consoles can be changed to another available language by invoking a language feature key or by using the wildcard feature. See table FNMAP.

If a console is not provided with a feature or wildcard key, the operating language can be changed only by changing the default language in table ATTCONS. This requires removing the console from service, changing the option LANG, and returning the console to service.

The alternative language for ICI names is not provided by this feature because they are `names of things,' not messages.

The set of trouble codes are defined by the switch owner through datafill to allow the attendant to classify problems encountered. These codes and their associated messages are datafilled on a system-wide basis for log reports for maintenance personnel and should be input in an appropriate language. These messages appear on the attendant console in only the language used for trouble code input and are not affected by this feature.

The time and date displays are not flexible on a per-language basis. Although the month and day appear in the alternative language, the order of the month and day on the display may not be appropriate in all languages.

ACLANG (end)

If a console is removed from service due to maintenance (automatic or manual), and is subsequently returned to service, it uses the language it was operating in prior to the maintenance action.

Unjacking and jacking in of headsets/handsets has no effect on the console's operating language.

The language keying sequence can be input at any time, as long as there is a headset or handset jacked in. If the keying sequence is valid, it remains in effect for the next call.

When the attendant console receives a treatment, the corresponding treatment message is displayed. A treatment log is also produced which contains the treatment message that was displayed. This log contains the English version of the message, as it is intended for the use of maintenance personnel, not the attendant. It is possible to translate the message to French, if the logs are output in French for the office.

This feature is completely optional. Without the flexible display language feature, tables ACLANG and ACMSG are not required. Attendant console message displays are based on the system-defined English language messages. The feature is only necessary for an office requiring one or more additional languages other than English.

ACLOGID

Table name

Attendant Console Login ID Table

Functional description

Table ACLOGID allows attendant console operators to log in to and log out from the switch. Log reports are generated that indicate which users were at a particular console during a given time frame.

A LOGIN/LOGOUT key is assigned to the attendant consoles if feature AD0939 (Console Operator Login) is enabled. To login, press the LOGIN/LOGOUT key and enter your three-digit login identification (ID).

Table ACLOGID contains all valid login IDs. The login ID must be contained in this table for the login to be valid. This table also screens login IDs for both customer groups and subgroups.

Datafill sequence and implications

Table CUSTCONS must be datafilled before table ACLOGID.

Table size

0 to 999 tuples

Datafill

The following table lists datafill for table ACLOGID.

Field descriptions (Sheet 1 of 2)

Field	Subfield or refinement	Entry	Explanation and action
LOGINID		001 to 999	<i>Login identifier</i> Enter the login ID. Any entry outside the range indicated for this field is invalid.
CUSTSEL		Y or N	<i>Customer group selector</i> Enter Y (yes) for customer group screening. Otherwise, enter N (no). If the value of field CUSTSEL is Y, datafill refinements CUSTGRP and SUBGRP.

ACLOGID (end)**Field descriptions (Sheet 2 of 2)**

Field	Subfield or refinement	Entry	Explanation and action
USERNAME	CUSTGRP	alphanumeric (16 characters)	<i>Customer group</i> If the value of field CUSTSEL is Y, enter the customer group name. If the value of field CUSTSEL is N, do not datafill this refinement.
	SUBGRP	0 to 7	<i>Subgroup</i> If the value of field CUSTSEL is Y, enter the subgroup number within the specified customer group to which the ID is associated. If the value of field CUSTSEL is N, do not datafill this refinement.
		alphanumeric (vector of up to 8 characters)	<i>User name</i> Enter the user name associated with the specified ID. This field identifies which operator uses a particular login ID.

Datafill example

The following table lists datafill for table ACLOGID.

In this example, OPER1 uses 008 as a login ID. There is no customer group screening.

MAP display example for table ACLOGID

LOGINID	CUSTINFO	USERNAME
008	N	OPER1

ACMSG

Table name

Attendant Console Messages Table

Functional description

Table ACMSG contains all messages used for the attendant console. The master set of English messages in this table is for reference purposes only and cannot be changed or deleted. If a new language is defined in table ACLANG, a duplicate English master set appears in table ACMSG. The language name in the keys of the new set is the name of the new language. These tuples must be changed to provide translations of the standard English messages.

Each set of messages is split into five types:

Day

Day message types contain all seven abbreviations of the days of the week. The message size is three characters.

Message

Messages are used as single-part displays for the console and are restricted to a maximum of 16 characters in length with the exception of MESSAGE 0. Translations for MESSAGE 0, NO_SUPV, must not exceed seven characters. Messages displayed on the console are left-justified and padded with blanks on the right (if necessary).

Month

Month message types contain all twelve abbreviations of the months of the year. The message size is three characters.

Prefix

Prefixes are one or two letters used to prefix a display with a feature that has altered the routing of a call. The only prefix currently in use is for call forwarding.

Treatment

Treatments are used as double-part displays and are restricted to 13 characters. Treatments displayed on the console are right-justified.

The first part of the key is the language name, the second part is the message type. The third part of the key is a number from 0 (zero) to x minus one, where x is the number of messages of that type defined in the current BCS. Corresponding messages or translations have the same message type and message number.

ACMSG (continued)

The following are rules for replacement strings.

- System-defined messages do not exceed the maximum length imposed by the English equivalent. This does not constrain word size, only total message length. Message length is usually 16 characters (the size of the display), or smaller. Digits and prefixes are displayed with the messages.
- The character set of an alternate language is restricted to the letters A through Z, the digits 0 through 9, and the special characters &<>*,-./:=_ (some special characters may not appear exactly as shown here).
- Strings must be entered with underscores instead of blanks inside the message. Blanks are interpreted as the start of a new field. If any of the special characters are used in the string, the string must also be entered surrounded by single quotes. Tuples in tables ACLANG and ACMSG are displayed showing underscores where specified. Messages displayed on the console display have the underscores replaced by blanks.

For related information, refer to tables ACLANG and TMTCNTL.TREAT.

Table Messages and Explanations lists messages used for translation and their meanings.

Messages and Explanations (Sheet 1 of 13)

Type	Number	Message	Explanation
MSG	0	NO_SUPV	Indicates that the trunk CLLI being displayed has no disconnect supervision.
MSG	1	CONFEREE_ADDED	A party was added to a conference.
MSG	2	CONFERENCE_CALL	The party on the loop is a conference bridge.
MSG	3	WRONG_LOOP_STATE	Loop in wrong state for action taken.
MSG	4	PLEASE_TRY_AGAIN	Software resources unavailable for requested action.
MSG	5	NETWORK_BLOCK	A network blockage has occurred.
MSG	6	DISALLOWED	Action is not allowed or code dialed is disallowed.

ACMSG (continued)**Messages and Explanations (Sheet 2 of 13)**

Type	Number	Message	Explanation
MSG	7	SRC_OFF-HOOK	The source on the loop has gone off-hook.
MSG	8	DEST_OFF-HOOK	The destination on the loop has gone off-hook.
MSG	9	SRC_DISCONNECT	The source on the loop has disconnected.
MSG	10	DEST_DISCONNECT	The destination on the loop has disconnected.
MSG	11	CONF_DISCONNECT	The conference on the loop has disconnected.
MSG	12	SRC_PREEMPTED	The source on the loop was preempted.
MSG	13	DEST_PREEMPTED	The destination on the loop was preempted.
MSG	14	SRC_ON-HOOK	The source on the loop has gone on-hook.
MSG	15	DEST_ON-HOOK	The destination on the loop has gone on-hook.
MSG	16	NO_FREE_LOOP	Feature activated requires an idle or active loop and none are available.
MSG	17	NO_ACTIVE_LOOP	Feature activated requires an active loop and none are available.
MSG	18	NS:_INPUT	Night Service feature waiting for input.
MSG	19	BVL:_INPUT	Busy Verification Line feature waiting for input.
MSG	20	BVT:_INPUT	Busy Verification Trunk feature waiting for input.
MSG	21	GTGB:_INPUT	Group Trunk Group Busy feature waiting for input.

ACMSG (continued)**Messages and Explanations (Sheet 3 of 13)**

Type	Number	Message	Explanation
MSG	22	GTAC:_INPUT	Group Trunk Group Access feature waiting for input.
MSG	23	WC:_INPUT	Wildcard feature waiting for input.
MSG	24	ACCT:_INPUT	Account Code feature waiting for input.
MSG	25	AUTH:_INPUT	Authorization Code feature waiting for input.
MSG	26	AUVAL:_INPUT	Authorization Code validation feature waiting for input.
MSG	27	SC_USAGE:_INPUT	Speed Calling Usage feature waiting for input.
MSG	28	SC_PROG:_INPUT	Speed Calling Programming feature waiting for input.
MSG	29	**NO_DATA-FILL**	Missing datafill.
MSG	30	INVALID_CODE	Invalid code dialed.
MSG	31	TROUBLE:_INPUT	Trouble feature waiting for input.
MSG	32	1_SHORT_BUZZ	Short buzz selected for Flexible Console Alerting feature.
MSG	33	2_TONE	Tone selected for Flexible Console Alerting feature.
MSG	34	3_TONE_AND_BUZZ	Tone and short buzz selected for Flexible Console Alerting feature.
MSG	35	4_LONG_BUZZ	Long buzz selected for Flexible console Alerting feature.
MSG	36	BUZZ:_INPUT	Flexible Console Alerting feature waiting for input.

ACMSG (continued)**Messages and Explanations (Sheet 4 of 13)**

Type	Number	Message	Explanation
MSG	37	DND:_INPUT	Do Not Disturb feature waiting for input.
MSG	38	PARK:_INPUT	Call Park feature waiting for input.
MSG	39	UNPARK:_INPUT	Call Unpark feature waiting for input.
MSG	41	LANGUAGE:_INPUT	Flexible language feature waiting for input.
MSG	42	AUTODIAL:_INPUT	Automatic Dial feature waiting for input to program AUTODIAL key.
MSG	43	TOO_MANY_DIGITS	Attendant Console End to End Signaling feature attempts to enter and send more than 15 digits at a time.
MSG	44	MW:_INPUT	Message Waiting feature waiting for input.
MSG	45	GVAC:_INPUT	Global Virtual Facility Group Access Control feature waiting for input.
MSG	46	GVGB:_INPUT	Global Virtual Facility Group Busy feature waiting for input.
MSG	47	CF:_INPUT	Call Forwarding feature waiting for input.

ACMSG (continued)**Messages and Explanations (Sheet 5 of 13)**

Type	Number	Message	Explanation
MSG	49	DQC:_INPUT	The operating company has activated the Display Queued Calls feature and the system is waiting for an input. If # is entered, system displays the number of calls queued for the console subgroup. If an incoming call identification code is entered, the system displays the number of calls queued, and the time, in seconds, that the oldest call has been waiting.
MSG	50	NO_CALLS_QUEUED	The operating company has accessed the Display Queued Calls feature and entered a number in response to a system prompt. The display indicates that there are no calls in the subgroup or ICI queue.
MSG	51	IDLE_LOOP	An inactive loop key is pressed (there is no source or destination and the key is not being used by an attendant).
MSG	52	3_WAY_CALL	Three Way Calling feature active on call.
MSG	53	SRC_DGTS:_INPUT	Attendant Console End to End Signaling (DTMF) feature waiting for source input.
MSG	54	DEST_DGTS:_INPUT	Attendant Console End to End Signaling (DTMF) feature waiting for destination input.
MSG	55	DIGITS_SENT	Attendant Console End to End Signaling (DTMF) and the digits were sent.

ACMSG (continued)**Messages and Explanations (Sheet 6 of 13)**

Type	Number	Message	Explanation
MSG	56	WAIT:_800_CALL	Displayed while waiting for the database response.
MSG	57	WAIT	Attendant Console End to End Signaling (DTMF) feature sending dual tone multifrequency (DTMF) digits on a circuit that is on-hook.
MSG	58	WAIT:_PVN_CALL	Private virtual network (PVN) waiting for input.
MSG	59	OHQ	Offhook queuing applies to the call placed by the attendant. Call must be routed out a trunk.
MSG	60	PVN_AUTH/PIN_RQD	A database query indicates that an authorization code is required to complete the PVN call.
MSG	61	AUTH_PIN:_INPUT	PVN is ready to receive an authorization code.
MSG	62	RMAC_NUM:_INPUT	The PVN remote access is ready to receive digits.
MSG	63	INVALID_NUMBER	A PVN remote access directory number is invalid, or an attendant entered an invalid calling DN for a PVN call.
MSG	64	MORE:	The Display Control (DSPC) key is hit and extra screen information is available (more than 32 bytes).
MSG	65	LOGIN:_INPUT	The AC Login feature is ready to receive the login identifier.
MSG	66	LOGGED_OUT	A console that logged in through the AC Login feature has logged out.

ACMSG (continued)**Messages and Explanations (Sheet 7 of 13)**

Type	Number	Message	Explanation
MSG	67	REMOTE_AC_CNCTD	An attendant is routed to another attendant through an ISDN user part (ISUP) trunk.
MSG	68	UPAB_:CALL_BLKED	A universal public access (UPA) call is blocked.
MSG	69	SOR:_INPUT	Station originated restriction waiting input.
MSG	70	NO_NAME_INFO	The Name Display key was hit but no information is available.
MSG	71	PGCNF_:INPUT	The Progressive Conference (PGCNF) feature is waiting for input.
MSG	72	WAIT:_008_CALL	The enhanced inward call management (E008) call is waiting for a database response.
MSG	73	NRLT:_INPUT	The Network Attendant Service Release Link Trunk (NRLT) feature is waiting for input.
MSG	74	NRLT_REACTIVATED	The NRLT feature was reactivated at the attendant console.
MSG	75	NO_INFO	The call originated outside the attendant's customer group and the inter Calling Number Blocking (INTERCNB) option is assigned to the console. Displayed instead of the calling directory number.

ACMSG (continued)**Messages and Explanations (Sheet 8 of 13)**

Type	Number	Message	Explanation
MSG	76	PRIVATE	The Calling Number Blocking (CNB) or Calling Number Delivery Blocking (CNDB) option is assigned to the incoming directory number. Displayed instead of the calling directory number.
TRMT	0	**UNDEFINED**	
TRMT	1	**UNDEFINED**	There is a problem allocating software resources, or a requested network connection cannot be made.
TRMT	2	TRY_AGAIN	Failure to get system resources.
TRMT	3	ALL_CKTS_BUSY	All circuits for number dialed are busy.
TRMT	4	PARTIAL_DIAL	Insufficient digits dialed to complete call.
TRMT	5	DISALLOWED	Action is not allowed or code dialed is disallowed.
TRMT	6	DIALING_ERROR	Error in the number dialed.
TRMT	7	NETWORK_BLOCK	A network blockage has occurred.
TRMT	8	DEFLECTED	Deflected to emergency treatment through network management or from the MAP (maintenance and administration position).
TRMT	9	INTERCEPTED	Call was intercepted by another attendant, operator or recorded announcement.
TRMT	10	UNASSIGNED_DN	The number dialed is not assigned as a directory number.

ACMSG (continued)**Messages and Explanations (Sheet 9 of 13)**

Type	Number	Message	Explanation
TRMT	12	BUSY	Dialed number is busy.
TRMT	13	BSY_NO_CAMPON	Dialed number is busy and cannot be camped on.
TRMT	14	TERM_DENIED	Termination on dialed number denied.
TRMT	15	TOLL_DENIED	Toll call has been denied because of calling number restrictions.
TRMT	16	TRUNK_TROUBLE	Trouble seizing trunk.
TRMT	17	INVALID_ICI	Invalid ICI entered for feature input.
TRMT	18	INPUT_ERROR	An input error for the active feature.
TRMT	19	UPDATE_OK	The active feature has succeeded in updating its data.
TRMT	20	INVALID_CODE	Invalid code dialed.
TRMT	21	INVALID_NMBR	Invalid number dialed.
TRMT	22	NDC_IN_EFFECT	Busy verify fails because there is no double connect on call.
TRMT	23	IDLE_TRUNK	Trunk is idle.
TRMT	24	BARGE_IN	Barge-in succeeded with busy verify.
TRMT	25	TEST:BARGE_IN	Barge-in succeeded with busy verify - verify only.
TRMT	26	INVALID_GROUP	Trunk group input invalid.
TRMT	27	VALID_CODE	Valid code dialed.
TRMT	28	IDLE_LINE	Line is idle.

ACMSG (continued)**Messages and Explanations (Sheet 10 of 13)**

Type	Number	Message	Explanation
TRMT	29	DND_ACTIVE	Station has Do Not Disturb (DND) option active.
TRMT	30	ACTIVATED	An optional feature such as Night Service was activated.
TRMT	31	DEACTIVATED	An optional feature such as Night Service was deactivated.
TRMT	32	GRP_LIMIT_MET	Cannot park because limit exceeded.
TRMT	33	CALL_PARKED	Successfully parked a call.
TRMT	34	INVALID_TRUNK	Trunk member invalid.
TRMT	35	PREEMPT_WAIT	Four-wire subscriber is being preempted.
TRMT	36	MSB_ACTIVE	Station has message and switching buffer (MSB) active.
TRMT	37	IDLE:_NO_CNTL	Global Virtual Facility Group (VFG) feature is inactive and the VFG is idle.
TRMT	38	IDLE:_CNTL_ON	Global VFG Access Control feature is active and the VFG is idle.
TRMT	39	BUSY:_NO_CNTL	Global VFG Access Control feature is inactive and the VFG is busy.
TRMT	40	BUSY:_CNTL_ON	Global VFG Access Control feature is active and the VFG is busy.
TRMT	41	MISSING_AIOD_	Missing automatic identified outward dialing.
TRMT	42	NO_THRU_DIAL_	The attendant attempted to release a call before all digits were present and the Thru-dial option through Campon does not apply.

ACMSG (continued)**Messages and Explanations (Sheet 11 of 13)**

Type	Number	Message	Explanation
TRMT	43	ANSWER_TIMEOUT	An answer time-out message is received from an audio tone detector (ATD).
TRMT	44	NOT_ACCEPTED	The operating company cannot originate or extend calls to stations that do not have a transfer capability of speech.
TRMT	46	CONGESTION	The call cannot be completed because of far or near end congestion.
TRMT	47	BAD_TRK_STATE	A call is routed from an attendant to a trunk that is in an invalid state such as manual busy (MANB), system busy (SYSB).
TRMT	48	PVN_TROUBLE_	Miscellaneous trouble during the processing of a PVN call, such as database time-out.
TRMT	49	CHANGED_NUM_	A signaling system 7 (SS7) trunk indicates that a special announcement is to be applied: CHANGED NUMBER ANNOUNCEMENT.
TRMT	50	ROUTE_TO_DA_	An SS7 trunk indicates that a special announcement is to be applied: CHANGED NUMBER FORWARDED.
TRMT	51	CAMPON_NO_CKT	Not currently valid.
TRMT	52	TRY_CAMPON	An attendant extended a call over an ISDN user part (ISUP) trunk, or a trunk that uses SS7 signaling, to a busy subscriber. Network Attendant Services (NAS) Campon applies.

ACMSG (continued)**Messages and Explanations (Sheet 12 of 13)**

Type	Number	Message	Explanation
TRMT	53	CAMPON_FAIL	A failure occurred during the invocation of NAS Campon.
TRMT	54	UPA_BLOCKED	The call was blocked because of UPA restrictions.
TRMT	56	ACCESS FRAUD	Treatment was deleted from the load. Not currently valid.
TRMT	57	WAIT:VPN_CALL	The system is waiting for a response to a QUERY VPN SCP command.
PREFIX	0	CF	The call was forwarded.
PREFIX	1	S:	The Name Display key is pressed and the source party name is displayed in the form of S: <name> or S: NO NAME INFO.
PREFIX	2	D:	The Name Display key is pressed and the destination party name is displayed in the form of D: <name> or D: NO NAME INFO.
DAY	0	MON	Monday
DAY	1	TUE	Tuesday
DAY	2	WED	Wednesday
DAY	3	THUR	Thursday
DAY	4	FRI	Friday
DAY	5	SAT	Saturday
DAY	6	SUN	Sunday
MONTH	0	JAN	January
MONTH	1	FEB	February
MONTH	2	MAR	March

ACMSG (continued)**Messages and Explanations (Sheet 13 of 13)**

Type	Number	Message	Explanation
MONTH	3	APR	April
MONTH	4	MAY	May
MONTH	5	JUN	June
MONTH	6	JUL	July
MONTH	7	AUG	August
MONTH	8	SEP	September
MONTH	9	OCT	October
MONTH	10	NOV	November
MONTH	11	DEC	December

Datafill sequence and implications

There is no requirement to datafill other tables prior to table ACMSG.

Table size

98 to 5120 tuples

Memory is allocated dynamically when a new language (not English) is added to table ACLANG. The maximum size of tuples equals the number of languages in table ACLANG times the number of defined English messages.

Datafill

The following table lists datafill for table ACMSG.

Field descriptions (Sheet 1 of 2)

Field	Subfield or refinement	Entry	Explanation and action
MSGKEY		see subfields	<i>Message key</i> This field consists of subfield KEYNO.
	KEYNO	see refinements	<i>Key number</i> This field consists of refinements LANGUAGE, MSGTYPE, and MSGNUM.

ACMSG (continued)

Field descriptions (Sheet 2 of 2)

Field	Subfield or refinement	Entry	Explanation and action
MESSAGE	LANGUAGE	alphabetic (1 to 16 characters)	<i>Language</i> Enter the language name corresponding to an entry in table ACLANG. Up to eight different language names are provided.
	MSGTYPE	DAYMONTH MSGPREFIX or TRMT	<i>Message type</i> Enter one of the following: <ul style="list-style-type: none"> • DAY A day of the week. Message length is restricted to a maximum of three characters. • MONTHA month of the year. Message length is restricted to a maximum of three characters. • MSGA single-part display for the console. Message length is restricted to a maximum of 16 characters. Only MSG 0 cannot exceed seven characters. • PREFIXA prefix for other messages on the console display. Message length is restricted to a maximum of two characters. • TRMTA double-part display for the console. Message length is restricted to a maximum of 13 characters.
	MSGNUM	0 to 127	<i>Message number</i> Enter the sequence number for the message. See table Messages and Explanations.
		alphanumeric (1 to 16 characters)	<i>Message</i> Enter a string of characters used for translation of the corresponding English message. Allowable characters are A to Z, 0 to 9, and &<>*,-./:=_ If any of the special characters are used in a string, the string must be enclosed by single quotes.

ACMSG (end)

Datafill example

The following example shows sample datafill for table ACMSG, for English language only.

MAP display example for table ACMSG

	MSGKEY		MESSAGE
ENGLISH	MSG	0	NO_SUPV
ENGLISH	MSG	1	CONFEREES_ADDED

Table history
BCS36

Message types, numbers, and explanations, messages 71 to 76, and treatments 56 and 57 were added to table Messages and Explanations.

ACRTE

Table name

Access Code Route Table

Overview

The following is a list of the universal translations routing tables:

- ACRTE
- CTRTE
- FARTE
- FTRTE
- NSCRTE
- OFCRTE
- PXRTE

Use table ACRTE to datafill all the universal translations routing tables listed above. Exceptions relating to specific tables and datafill are noted where applicable.

For related information, refer to table ACHEAD.

Functional description

The route tables specify the route or routes to be followed after call translation.

Each route table contains the following fields:

- XLANAME — valid name from the corresponding HEAD table
- RTEREF — route reference index (1 to 1023)
- RTELIST — route list composed of a list of up to eight routes; each route has a selector, subfield RTESEL, and associated subfields

ACRTE (continued)

The following table indicates the refinements that can be datafilled in subfield RTESEL:

Route selector refinements (Sheet 1 of 3)

Entry in subfield RTESEL	Refinement	Explanation
CND	CONDITION	Specifies NRR or TOD plus refinements as CNDSEL. Note: The CDN NRR option is not supported in GSM offices.
	CONDRTE	One of ST, SK, or T plus refinements
DCRT	DCR_NETWORK	Network to which DCR destination node belongs to. This is one of the networks datafilled in table DCRNETID.
	DESTNAME	Valid destination node name from table DESTKEY
	OSID	Index into table DESTNODE, field OSID contains outpulsing scheme
N	CLLI	Common language name of a trunk group
	MODCHG	Modifies standard charging characteristics.
	DELETE	Number of digits to delete (0 to 8)
	PFXDIGS	Digits to prefix (up to 11 digits)
NODE	DCR_NETWORK	Network to which DCR destination node belongs. This is one of the networks datafilled in table DCRNETID.
	DESTNAME	Valid destination node name from table DESTKEY
	OSID	Index into table DESTNODE, field OSID contains outpulsing scheme.
NOT	CONDITION	Specifies NRR as CNDSEL.
	CONDRTE	One of ST, SK, or T plus refinements
RT	RTDIGITS	The digits to be retranslated.

ACRTE (continued)**Route selector refinements (Sheet 2 of 3)**

Entry in subfield RTESEL	Refinement	Explanation	
S SG	XLASYS	One of AC, AM, CT, FA, FT, NSC, OFC, or PX	
	XLANAME	Valid name from head table of XLASYS	
	CLLI	Common language name of a trunk group	
		Routes to a trunk group selected from those in the specified tuple in table SUPERTKG.	
	ALGORITHM	Call distribution method, either cyclical (CYC) or random (RND)	
	ATTEMPTS	The maximum number of trunk groups to be tested for a free trunk member.	
	SUPERTKG_NAME	The name of the super-group previously datafilled in table SUPERTKG	
SO	OPTIONS	An optional digit manipulation index (DMI) to table DIGMAN which allows the called number characteristics to be manipulated. Also an option of CALLTYPE, or type of call, is presented.	
		Longhaul or SETCDN option from table PXRTE for ETSI ISUP trunks	
		Note: The entry SO in subfield RTESEL is not valid for any universal translation routing tables.	
	CLLI	Common language name of a trunk group	
	DELETE	Number of digits to delete (0 to 18).	
	AFTER	Number of leading digits after which to insert prefix digits (0 to 18).	
	INSRT	Number of digits to insert.	
	OPTSEL	Option select (LONGHAUL, SETCDN, or \$)	
	SX	CLLI	Common language name of a trunk group

ACRTE (continued)**Route selector refinements (Sheet 3 of 3)**

Entry in subfield RTESEL	Refinement	Explanation
	ROUTATTR_INDEX	Index into table ROUTATTR containing expanded routing information.
T	XLASYS	One of AC, AM, CT, FA, FT, NSC, OFC, or PX
	XLANAME	Valid name from head table of XLASYS
	RTEREF	Route reference index (1 to 1023)

The key to the route tables consists of the translation name (XLANAME) and the route reference (RTEREF). The route reference index corresponds to the destination number (from option DEST) used in the code table for a given XLANAME.

The entry in field RTELIST is the route list associated with the RTEREF. It consists of up to eight routes, each with a selector and data.

Route descriptions**CND — Conditional time-of-day route**

Time-of-day routing consists of a series of tables that are used to define time-of-day and day-of-week or day-of-year time spans. There can be a maximum of 16 possible time spans. If invoked, the time-of-day conditional selector (CND TOD) finds the number of the time set that the current time falls in. If there is a match between it and the times supplied in field TIMES, the conditional route specified in field CONDRTE is used. If there is no match, the next route list element is evaluated.

ACRTE (continued)

Time-of-day uses the following format:

- **TODNAME** — The name of the specified TOD system defined as a time-of-day name in field TOD in table TODHEAD.
- **TIMES** — A set of times that have been defined for the time-of-day name in field TOD in table TIMEODAY.
- The following table shows time-of-day datafill for table PXRTE. The time-of-day maps to 3 (field TIMES), then routes to list P621 8 (put the call over REPAIR_TRUNK).

PXRTE datafill

XLANAME	RTEREF	RTESEL	TODNAME	TIMES	CONDRTE	CLLI
P621	7	CND	REPAIR	3	ST8	
P621	8	S				REPAIR_TRUNK

CND — Network rerouting

This feature provides a method of controlling traffic through route list datafill by making use of any alternate routes to particular destinations.

If traffic congestion occurs, the route list is searched for. In the route list, the network rerouting conditional selector (CND NRR) executes the conditional instructions in field CONDRTE. If this route list is encountered due to normal overflow, the conditional instructions are not executed.

Note: The CND NRR option is not supported in GSM offices.

DCRT - Dynamically controlled routing

Dynamically controlled routing (DCR) is used in offices with the DCR feature as the first element of a route list. DCR in universal translations is controlled by the standard Software Optionality Control (SOC) option DCR00004. The SOC option for DCR in universal translations (DCR00004) depends on the DCR Base SOC option (DCR00001).

The DCRT selector blocks the call if the DCR destination of the call is one link away from the DMS-100 switch and the second leg of the DCR tandem recommendation is not available.

ACRTE (continued)

GBL- Global Selector

Global selector GBL is introduced in all the routing tables. The GBL has two optional selectors, either one of which can be datafilled under the GBL selector. The optional selectors are as follows:

- CCNTRLRX
 - CCNTLIDX provides an index into table CALLCNTL
 - UPDATE_BILL_CALLCODE is a boolean that decides whether the CALLCODE value obtained from the second leg of the call can be updated in the callcode field of the AMA billing record.
 - UPDATE_BILL_DESTNUM is a boolean that which decides whether destination digits from the second leg of the call can be updated in the destination address digits field of the AMA record.
 - UPDATE_BILL_NCOS_CUSTNAME is a boolean that decides whether NCOS and CUSTGRP values from the second leg of the call can be updated in the respective fields of the AMA record.
 - DMI accepts a datafill in the range of 0-32767 and provides an index into table DIGMAN. When the DMI field is datafilled as '0', digit manipulation is not performed.
- OUTP - used as a trigger to index into table OUTPULSE

N — Nonstandard route

A trunk is selected from the trunk group, and digits are outpulsed according to fields DELETE and PFXDIGS. The digits to prefix are outpulsed first, followed by the received digits, with the exception of the received prefix digits and the number of digits entered in field DELETE. The standard charging characteristics can be modified by field MODCHG.

The options of the MODCHG field are as follows:

- NOMOD — For this value, no charge modification is required. The zone, as calculated by translations, is used for billing.
- CANCHG — On a route that is normally chargeable, cancel the charge.

Note: This feature is not available at this time.

ACRTE (continued)

- CANTOLL — On a route that is normally chargeable, reduce the charge to a local charge.

Note: This feature is not available at this time.

- ADDCHG — On a normally free route, charge for the call based on the zone calculated by translations. This is implemented for terminations to announcement. This allows announcement billing as required.

Internationally agreed telephony standards allow for the inclusion, in an outpulsed digit address, of signals that define the particular type of operator to which the call terminates. The Code 11 forward signal requires the incoming call to route to an operator at the termination exchange. The Code 12 forward signal requires the incoming call to route to a special international operator. Such operators handle specific calls, for example, prebooked calls.

If code 11 (B) or 12 (C), is outpulsed, the data entered in field PRXDIGS must be enclosed by single quotation marks, and the character must be in upper case, for example '442B'.

The International Telecommunications Union (ITU) recommendations for communication between international exchanges allows for a language or a discrimination digit in the inter-register signals. The language digit indicates which language to use between operators in the international service. The language digit must be sent on all semiautomatic calls.

The language digits available for insertion are:

- 1 (French)
- 2 (English)
- 3 (German)
- 4 (Russian)
- 5 (Spanish)

The discrimination digit occupies the same location as the language digit. The following values are recognized:

- 0 (basic automatic call)
- 7 (test call)

NODE — Dynamically controlled routing node

The node routing selector is used in offices with the DCR feature. If the office is used as a DCR switch, routing proceeds to table DESTNODE, field DESTKEY, which is equal to field DESTNAME associated with this selector.

ACRTE (continued)

NOT — Network rerouting

The route list is searched for the not network rerouting (NOT NRR) conditional selector in the route list if congestion occurs. However, the conditional instructions are not executed, and the next route in the route list is attempted. As the NOT NRR selector appears as an entry in the route list, it can be indexed due to normal overflow. In this instance, the conditional instructions are executed, because congestion has not occurred.

NS - Non-standard routing (enhanced)

This selector has the ability to prefix, delete and skip upto 22 digits from the number to be outpulsed. The sub-fields of NS selector are as follows:

- DEL_DIGS - deletes the number of digits to be deleted from the called digits prior to outpulsing. It deletes up to 22 digits from the CdPN (Called Party Number).
- PFX_DIGS - specifies the digits to be PreFiXed to the called digits. It accepts a datafill in the range of 0 to 22.
- PFX_AFTER - specifies the number of digits to be skipped before PreFiXing. It accepts a number whose length is in the range of 0 to 22.

RT — Retranslation route

Retranslation uses the information provided in its refinement, which allows the system to change trunk routing and to do translations with a directory number in order to route to a line.

S — Standard route

A trunk is selected from the trunk group (by CLLI), and digits are outpulsed according to the standard outpulsing algorithm. This algorithm ignores prefix digits, and outpulses the rest of the received digits.

SG - Selector value option

Routes to a free trunk in a trunk group selected from those in the specified tuple in table SUPERTKG. Can also access table DIGMAN for digit manipulation functions. Additionally, the type of call (CALLTYPE) field is available. This field may be Public, Private, WATS, ASDS, LDS, Foreign exchange, TIE, or INWATS.

SO — Standard with options

Supports ETSI ISUP trunks. A trunk is selected from the trunk group (by CLLI), and digits are outpulsed after manipulation by the user. Digits may be deleted, prefix digits (referenced from table PFXDIGS) may be added at any position within the CLLI number, and the LONGHAUL or SETCDN option may be specified. The option determines whether the outgoing route is sufficiently long to activate an echo canceller device.

ACRTE (continued)**SX — Expanded standard route**

Expanded standard outpulsing algorithm. This algorithm ignores prefix digits, and outpulses the rest of the received digits.

T — Table name route

Route control is passed to the route list specified in fields XLASYS, XLANAME, and RTEREF, and further routes in the current route list are ignored. Currently, routing is limited to eight routes in a route list. The T selector makes it possible to chain together any number of route lists.

Datafill sequence and meaning

Table TRKSGRP must be datafilled before datafilling the universal translations route tables.

Table size

Memory is allocated dynamically. When the first tuple for a given XLANAME is added, table size is allocated to accommodate the given route reference. As tuples are added, the table increases to accommodate the largest route reference index.

Datafill

The following table lists datafill for table ACRTE.

Field descriptions (Sheet 1 of 4)

Field	Subfield	Entry	Explanation and action
XLANAME		alphanumeric (1 to 8 characters) or NIL	Translation name. Enter the name assigned to the corresponding translation system head table. This is the first part of a two-part key to table ACRTE.
RTEREF		numeric (1 to 1023)	Route reference. Enter the route reference index that corresponds to the destination (from option DEST) used in table ACCODE for the given XLANAME. This is the second part of a two-part key to table ACRTE.
RTELIST		see subfield	Route list. This field consists of subfield RTESEL and refinements dependent on the value in subfield RTESEL. The route list consists of up to eight routes, each route has a selector and data.

ACRTE (continued)**Field descriptions (Sheet 2 of 4)**

Field	Subfield	Entry	Explanation and action
	RTESEL	CND, DCRT, GBL, GBL-CCNTL RX, GBL-OUTP, N, NS, NODE, NOT, RT, S, SG, SO, SX, T	<p>Route selector. Enter a maximum of eight of the following values.</p> <p>Enter CND (conditional route) and datafill refinements CONDITION and CONDRTE.</p> <p>If the route is conditional on the time-of-day (CND TOD), the call is transferred to the route list or element specified, if one of the times specified in field TIMES matches one of the times specified in table TIMEODAY.</p> <p>If a congestion message is received, the conditional network rerouting selector (CND NRR) of the universal routing tables is executed. The selector supports three types of conditional instructions, step (ST), skip (SK), and table (T).</p> <p>Note: The CND NRR option is not supported in GSM offices.</p> <p>If no conditional reroute selectors are found in the route list upon receipt of a congestion message, the call goes to treatment.</p> <p>Note: TOD routing consists of a series of tables that define time-of-day and day-of-week or day-of-year time spans. There can be a maximum of 16 possible time spans. If invoked, the TOD system finds the number of the set the current time falls in. If there is a match between it and the supplied TIMES set, TRUE is returned and the RTETYPE clause is executed. If FALSE is returned, the next route list element is evaluated.</p> <p>See table "PXRTE datafill" for an example for CND.</p>

ACRTE (continued)

Field descriptions (Sheet 3 of 4)

Field	Subfield	Entry	Explanation and action
			<p>Enter DCRT (dynamically controlled routing tandem) as the first route selector and datafill refinements DCR_NETWORK, DESTNAME, and OSID. DCRT is used for DCR tandem calls that arrive on a DCR trunk group within the same network.</p>
			<p>Note: DCRT is datafilled only once in a route list.</p>
			<p>Enter N (non-standard route) and datafill refinements CLLI, MODCHG, DELETE, and PFXDIGS. A trunk is selected from the trunk group and the digits outpulsed according to fields DELETE and PFXDIGS. The digits to prefix are outpulsed first, followed by the received digits, with the exception of the received prefix digits and the number of digits given by field DELETE. The standard charging characteristics can be modified by field MODCHG.</p>
			<p>Enter NODE and datafill refinements DCR_NETWORK, DESTNAME, and OSID. NODE is used for DCR calls that are to be carried on an alternate (recommended) route.</p>
			<p>Note: NODE is datafilled only once in a route list.</p>
			<p>Enter NOT (network rerouting) and datafill refinements CONDITION and CONDRTE, if conditional instructions are not to execute when congestion occurs. Instead, the next route in the route list is attempted. Since selector NOT NRR (NOT) appears as an entry in the route list, it can be indexed due to normal overflow. In this instance, conditional instructions are executed, since congestion has not occurred.</p>

ACRTE (continued)**Field descriptions (Sheet 4 of 4)**

Field	Subfield	Entry	Explanation and action
			<p>Enter RT (retranslation route) and datafill refinements RT_DIGITS, XLASYS, and XLANAME, if the digits received are replaced in their entirety by the number specified and then retranslated in the translation system specified. Retranslation is done using the information provided in the refinements. This allows the system to change trunk routing and to do translations with a directory number in order to route to a line.</p> <p>Enter S (standard route) and datafill refinement CLLI, if the route is standard. A trunk is selected from the trunk group (given by the common language location identifier (CLLI)) and digits are outputted according to the standard outputting algorithm. This algorithm ignores prefix digits, and outputted the rest of the received digits.</p> <p>Enter SG (super trunk group) and datafill refinements ALGRTHM, ATTNO, SGNAME, DMI, and CALLTYPE.</p> <p>Enter SO (Standard with options) and datafill refinement CLLI. SO allows datafill of subfield OPTSEL with either LONGHAUL (specifies that echo cancelling is required), SETCDN or \$ (no options selected). SO supports ETSI ISUP.</p> <p>Enter T (table name route) and datafill refinements TABNAME, XLASYS, XLANAME, and RTEREF, if the route is to route to a route table. Control is passed to the route list specified in the refinements. Further routes in the route list are ignored. This overcomes the restriction of having only eight routes in a route list by making it possible to chain together any number of route lists, each with up to eight routes.</p>

ACRTE (continued)**RTESEL = CND**

If the entry in subfield RTESEL is CND, datafill subfields CONDITION and CONDRTE, as described in the following table.

Field descriptions for conditional datafill

Field	Subfield	Entry	Explanation and action
	CONDITION	see subfields	Condition for routing. This refinement consists of subfield CNDSEL.
	CNDSEL	NRR or TOD	<p>Conditional selector. Enter TOD for the time-of-day and datafill subfields TODNAME and TIMES.</p> <p>Enter NRR to execute the CONDRTE instructions if congestion occurs.</p> <p>Note: The CND NRR option is not supported in GSM offices.</p> <p>The CNDSEL values: ALWAYS, CALLCHR, COSMAP, EA, INTERLATA, RND, SITE, SNPA, TOPEAALT, and TOPEAXFR, are not valid for universal translation RTE tables.</p>
	TODNAME	alphanumeric (1 to 8 characters)	Time-of-day name. Enter the name of the time-of-day system previously assigned in field TOD in table TODHEAD.
	TIMES	alphanumeric (0 to 9, A to F) (up to 14 characters)	Times set. Enter the times (maximum of 11 characters with no space between each time) when the transfer to another route list or element can occur. The time ranges are defined in table TIMEODAY, field TOD. If the current time is one of the times in the set, refinement CONDRTE is executed.

ACRTE (continued)**RTESEL = CND or NOT**

If the entry in subfield RTESEL is CND or NOT, datafill subfield CONDRTE as described in the following table.

Field descriptions for conditional datafill (Sheet 1 of 3)

Field	Subfield	Entry	Explanation and action
	CONDRTE	see subfields	Conditional route. This refinement consists of subfield RTETYPE and its refinements.
	RTETYPE	SK, ST, T	Route type. Enter the route type. Enter NOT for network rerouting. Enter SK and datafill subfield SKIPNUM, if the call is to skip to another route element in the same route list. Enter ST and datafill subfield RTEREF, if the call is to transfer to another route list in the same table. Enter T and datafill subfields TABNAME, XLASYS, XLANAME, RTEREF, or TABNAME, and INDEX, if the call is to transfer to a route list in one of the universal translation route tables.
	SKIPNUM	numeric (0 to 7)	Skip number. If the entry in subfield RTETYPE is SK, datafill this refinement. Enter the number of elements within the same route list to skip in order for the call to transfer to the proper route if the condition is met.
	RTEREF	numeric (1 to 1023)	Route reference number. If the entry in subfield RTETYPE is ST, datafill this refinement. Enter the route reference number in the same table that the call is transferred to if the condition is met. The route reference number to which the call is transferred, must be a higher number than the route reference number from which it was transferred.

ACRTE (continued)**Field descriptions for conditional datafill (Sheet 2 of 3)**

Field	Subfield	Entry	Explanation and action
	TABNAME	IBNRTE, IBNRT2, IBNRT3, IBNRT4, IRTE, OFRT, OFR2, OFR3, OFR4, RRTE, TOPS	<p>Table name. If the entry in subfield RTETYPE is T, enter the respective office route table name.</p> <p>For all entries except IRTE, datafill subfield INDEX.</p> <p>If IRTE is entered, datafill subfields XLASYS and RTEREF.</p> <p>Note: The entries IBNRTE, IBNRT2, IBNRT3, IBNRT4, RRTE, and TOPS are not valid if subfield RTSEL is set to CND for all universal translation routing tables.</p>
	INDEX	numeric (0 to 1023)	<p>Route reference index. If the entry in subfield RTETYPE is T, and the entry in refinement TABNAME is any entry other than RRTE or IRTE, datafill this refinement. Enter the index of the route table to which the call is transferred.</p>
	XLASYS	AC, AM, CT, FA, FT, NSC, OFC, or PX	<p>Translation system. If the entry in subfield RTETYPE is T and the entry in refinement TABNAME is IRTE, datafill this refinement. Enter the translation system to which the call is transferred.</p> <p>Note: NIL is not a valid entry. NIL is only used to satisfy internal software functionality.</p>
	XLANAME	alphanumeric (1 to 8 characters)	<p>Translation name. If the entry in subfield RTETYPE is T and the entry in refinement TABNAME is IRTE, datafill this subfield. Enter the translation name of the table instance within the XLASYS to which the call is transferred.</p>

ACRTE (continued)**Field descriptions for conditional datafill (Sheet 3 of 3)**

Field	Subfield	Entry	Explanation and action
	RTEREF	numeric (1 to 1023)	Route reference index. If the entry in subfield RTETYPE is T and the entry in refinement TABNAME is IRTE, datafill this subfield. Enter the index of the route table specified to which the call is to transfer.
	KEY	numeric (0 to 1023)	Route reference key. If the entry in subfield RTETYPE is T, and the entry in refinement TABNAME is RRTE, datafill this subfield. Enter the index key of the route table to which the call is transferred.

RTESEL = DCRT or NODE

If the entry in subfield RTESEL is DCRT or NODE, datafill subfields DCR_NETWORK, DESTNAME, and OSID as described in the following table.

Field descriptions for conditional datafill

Field	Subfield	Entry	Explanation and action
	DCR_NETWORK	alphanumeric	DCR network. The network of the DCR destination node as defined in table DCRNETID.
	DESTNAME	alphanumeric	DCR destination node name. The destination node name is one of the names datafilled in table DESTKEY.
	OSID	numeric (1 to 55)	Outpulsing scheme identification. OSID is the index into table DESTNODE, field OSID to identify the outpulsing scheme defined in table DESTNODE.

ACRTE (continued)**RTESEL = GBL**

If the entry in subfield RTESEL is GBL, datafill subfields CCNTRLRX, OUTP as described in the following table.

Field descriptions for conditional datafill

Field	Subfield	Entry	Explanation and action
	CCNTRLRX	Refer to GBL-CCNTRLR X	Provides an index into table CALLCNTL retranslating the call.
	OUTP	Refer to GBL-OUTP	Indexes into table OUTPUTPULSE

RTESEL = GBL-CCNTRLRX

If the entry in subfield RTESEL is GBL-CCNTRLRX, datafill subfields CCNTLIDX, UPDATE_BILL_CALLCODE, UPDATE_BILL_DESTNUM, UPDATE_BILL_NCOS_CUSTNAME, and DMI as described in the following table..

Field descriptions for conditional datafill

Field	Subfield	Entry	Explanation and action
	CCNTLIDX	Any string predefined in table CALLCNTL.	
	UPDATE_BILL_C ALLCODE	Y/N	Determines whether the Callcode value is to be updated in the AMA record from the first leg of the call.
	UPDATE_BILL_D ESTNUM	Y/N	Determines whether the Destination digits are to be updated in the AMA record from the first leg of the call.
	UPDATE_BILL_N COS_CUSTNAM E	Y/N	Determines whether NCOS and Customer name are to be updated from the first leg of the call.
	DMI	0 - 32767	Indexes into table DIGMAN

ACRTE (continued)**RTESEL = GBL-OUTP**

If the entry in subfield RTESEL is GBL-OUTP, datafill subfields CLLI, OUTPLS_IDX as described in the following table.

Field descriptions for conditional datafill

Field	Subfield	Entry	Explanation and action
	CLLI	Valid Trunk CLLI	Trunk on which the call terminates
	OUTPLS_IDX	0 - 1023	Indexes into table OUTPUTSE

RTESEL = N

If the entry in subfield RTESEL is N, datafill subfields CLLI, MODCHG, DELETE, PFXDIGS, and PFXAFTER as described in the following table.

Field descriptions for conditional datafill (Sheet 1 of 3)

Field	Subfield	Entry	Explanation and action
	CLLI	alphanumeric (1 to 16 characters)	Common language location identifier. Enter the common language location identifier (CLLI) of the trunk group to which the call is routed.
	MODCHG	ADDCHG, CANCHG, CANTOLL, NOMOD	Modify charging. Enter one of the following values: Enter ADDCHG if the route is normally free and a charge is added based on the zone calculated by translation. This is only applied to terminations to announcements, allowing for announcement billing.
	MODCHG		Enter CANCHG if a route is normally chargeable and the charge is canceled. Note: This feature is not presently available. Enter CANTOLL if a route is normally chargeable and the charge is reduced to a local charge. Note: This feature is not presently available. Enter NOMOD if no charge modification is required. The zone, as calculated by translations, is used for billing.

ACRTE (continued)**Field descriptions for conditional datafill (Sheet 2 of 3)**

Field	Subfield	Entry	Explanation and action
	DELETE	numeric (0 to 18)	Delete digits. Enter the number of digits to be deleted before outpulsing.
	PFXDIGS	alphanumeric (1 to 12 characters)	<p>Prefix digits. Enter prefix digits in the range 0 to 9 and/or N, or code 11, or code 12 .'N' represents the Hex A, Code 11 represents Hex B, and code 12 represents Hex C. If the data entered in this refinement contains either B or C, the data must be enclosed by single quotation marks and the letters must be in upper case, for example, '442B'.</p> <p>Digit 'N' is datafilled as a valid digit that represents digit 'A' in universal translations so that all overdecadic digits ('0' to 'F') can be datafilled together with other digits. A single 'N' means that no digits will be prefixed.</p> <p>Note: Internationally agreed telephony standards allow for the inclusion, in an outpulsed digit address, of signals that define the particular type of operator to which the call terminates. The Code 11 forward signal requires the incoming call to route to an operator at the terminating exchange. The Code 12 forward signal requires the incoming call to route to a special international operator. Such operators handle specific calls, for example, prebooked calls.</p>

ACRTE (continued)**Field descriptions for conditional datafill (Sheet 3 of 3)**

Field	Subfield	Entry	Explanation and action
	PFXDIGS		<p>Note: ITU recommendations for communication between international exchanges allow for a language or discrimination digit in the interregister signals. The language digit indicates the language to use between operators in international service. The language digit must be sent on all semiautomatic calls.</p> <p>The following language digits are available for insertion:</p> <ul style="list-style-type: none"> • 1 (French) • 2 (English) • 3 (German) • 4 (Russian) • 5 (Spanish) <p>The following discrimination digits occupy the same location as the language digit:</p> <ul style="list-style-type: none"> • 0 (basic automatic call) • 7 (test call)
	PFXAFTER	numeric (0 to 15)	Specifies the number of leading digits after which to insert prefix digits. Enter the number of leading digits to skip before inserting the digits specified in subfield PFXDIGS.

RTESEL = NS

If the entry in subfield RTESEL is NS, datafill subfields CLLI, DEL_DIGS, PFX_AFTER and PFX_DIGS as described in the following table.

Field descriptions for conditional datafill (Sheet 1 of 2)

Field	Subfield	Entry	Explanation and action
	CLLI	numeric (1 to 11 digits)	Enter CLLI that specifies the Common Language Location Identifier of a valid trunk.
	DEL_DIGS	0 to 22	Delete digits. Enter the number of digits to be deleted up to 22 digits from the CdPN.

ACRTE (continued)**Field descriptions for conditional datafill (Sheet 2 of 2)**

Field	Subfield	Entry	Explanation and action
	PFX_AFTER	0 to 22	Specifies the number of leading digits after which to insert prefix digits. Enter the number of leading digits to skip up to 22 digits.
	PFX_DIGS	Any number with a length in the range 0 to 22	Prefix digits. Enter the number of digits to be prefixed up to 22 digits to CdPN (Called Party Number).

RTESEL = RT

If the entry in subfield RTESEL is RT, datafill subfields RTDIGITS, XLASYS, and XLANAME as described in the following table.

Field descriptions for conditional datafill

Field	Subfield	Entry	Explanation and action
	RT_DIGITS	numeric (1 to 11 digits)	Digits to retranslate. Enter the digits that are retranslated in the appropriate translation system or table and replace the digits dialed.
	XLASYS	AC, AM, CT, FA, FT, NSC, OFC, or PX	Translation system. Enter the translation system that the digits are transferred to for retranslation. Note: NIL is not a valid entry. NIL is only used to satisfy internal software functionality.
	XLANAME	alphanumeric (1 to 8 characters)	Translation name. Enter the translation name of the table instance within the translation system to which the retranslated digits are transferred.

RTESEL = S

If the entry in subfield RTESEL is S, datafill subfield CLLI as described in the following table.

Field descriptions for conditional datafill

Field	Subfield	Entry	Explanation and action
	CLLI	alphanumeric (1 to 16 characters)	Common language location identifier. Enter the CLLI of the trunk group to which the call is routed.

ACRTE (continued)**RTESEL = SG**

If the entry in subfield RTESEL is SG, datafill subfields ALGRTHM, ATTNO, SGNAME, DMI, and CALLTYPE as described in the following table.

Field descriptions for conditional datafill (Sheet 1 of 2)

Field	Subfield	Entry	Explanation and action
	ALGORITHM	CYC or RND	Enter CYC to set the algorithm to cyclical. The first trunk group to be tested is selected in sequence for each call routing through the super-group. Enter RND to set the algorithm to random. The first trunk group to be tested is selected at random for each call routing through the super-group.
	ATTEMPTS	numeric (1 to 220)	Attempt number. Enter the maximum number of trunk groups to be tested for a free trunk member.
	SUPERTKG_ NAME	alphanumeric (1 to 16 characters)	Enter the name of the super-group.
	OPTIONS	OPTION	Enter up to two options (see datafill subfields DMI and CALLTYPE).

ACRTE (continued)**Field descriptions for conditional datafill (Sheet 2 of 2)**

Field	Subfield	Entry	Explanation and action
	CALLTYPE	PUBLIC, PriVaTe, WATS, ASDS, LDS, Foreign eXchange, TIE, INWATS	<p>Call Type. This subfield allows for switching of routing call-types on an as-needed basis.</p> <ul style="list-style-type: none"> Enter PUB for public routing of calls. Operator Access Type (OATYPE) has options (NONE, OM, OP). Transit Network Selector (TNS) has values (0 to 999, N, C). NPOS has values N, Y. Enter PVT for private routing of calls. Facility Number (FACNUM) has values 0 to 1023. Numbering Plan Indicator (NPI) has values E164 and PVT. Enter WATS for WATS routing of calls. Zone. Zone is ZONE_TYPE. Numbering Plan Indicator (NPI) has values E164 and PVT. CARRIER IS VECTOR OF UP TO 1 IC_INC_CARRIER_NAME'S. Enter ASDS for ASDS routing of calls. Numbering Plan Indicator (NPI) has values E164 and PVT. Enter LDS for LDS routing of calls. Numbering Plan Indicator (NPI) has values E164 and PVT. Enter FX for foreign exchange routing of calls. Facility Number (FACNUM) has values 0 to 1023. Numbering Plan Indicator (NPI) has values E164 and PVT. Enter TIE for TIE routing of calls. Facility Number (FACNUM) has values 0 to 1023. Numbering Plan Indicator (NPI) has values E164 and PVT. Enter INWATS for INWATS routing of calls. Facility Number (FACNUM) has values 0 to 1023. Numbering Plan Indicator has values E164 and PVT.
	DMI	numeric (1 to 32 767)	Enter DMI and the index number to table DIGMAN. This option allows the called number characteristics to be manipulated by the action of table DIGMAN.

ACRTE (continued)**RTESEL = SO**

If the entry in subfield RTESEL is SO, datafill subfields DEL, AFTER, INSRT, and OPTSEL as described in the following table.

Field descriptions for conditional datafill

Field	Subfield	Entry	Explanation and action
	CLLI	alphanumeric (1 to 16 characters)	Common language location identifier. Enter the CLLI of the trunk group to which the call is routed.
	DEL	0 to 18	Delete digits. Enter the number of digits to be deleted before outpulsing.
	AFTER	0 to 18	Number of leading digits after which to insert prefix digits. Enter the number of leading digits to skip before inserting the prefix digits specified in subfield PFXDIGS.
	INSRT	N or 1 to 11 digits	Number of digits to insert prefix digits. Enter the number of digits.
	OPTIONS		see subfield OPTSEL
	OPTSEL	LONGHAUL, SETCDN, or \$	Enter LONGHAUL to determine if the outgoing route is sufficiently long to activate an echo cancelling device. Enter SETCDN which has one subfield (CDNNAME) as defined in table CDNCHAR. The CDNNAME must be present in table CDNCHAR before the SETCDN option is datafilled. If the option is encountered for the selected route, then the specified CDNNAME determines the characteristic to use in the outgoing message. The SETCDN option in this selector can be used with any of the trunk types supported in table CDNCHAR.
	CDNNAME		Enter a valid CDNNAME from table CDNCHAR to define the outgoing call characteristics used.

ACRTE (continued)**RTESEL = SX**

If the entry in subfield RTESEL is SX, datafill subfields CLLI and ROUTATTR_INDEX as described in the following table.

Field descriptions for conditional datafill

Field	Subfield	Entry	Explanation and action
	CLLI	alphanumeric (1 to 16 characters)	Common language location identifier. Enter the CLLI of the trunk group to which the call is routed.
	ROUTATTR_ INDEX	alphanumeric (up to 16 characters)	Route attribute index. Enter the index into table ROUTATTR containing the expanded routing information to be applied to the call.

ACRTE (continued)**RTESEL = T**

If the entry in subfield RTESEL is T, datafill subfields TABNAME, XLASYS, XLANAME, RTEREF, and INDEX as described in the following table.

Field descriptions for conditional datafill (Sheet 1 of 2)

Field	Subfield	Entry	Explanation and action
	TABNAME	IBNRTE, IBNRT2, IBNRT3, IBNRT4, IRTE, OFRT, OFR2, OFR3, OFR4, OVRx (where x is 0 to 89) RRTE, TOPS	<p>Table name. If the entry in subfield RTESEL is T, enter the respective office route table name.</p> <p>If RRTE is entered, datafill refinements INDEX and KEY for all entries except IRTE.</p> <p>If IRTE is entered, datafill refinements XLASYS and RTEREF.</p> <p>Note: The entries IBNRTE, IBNRT2, IBNRT3, IBNRT4, and RRTE are not valid if subfield RTESEL is set to T in all universal translation routing tables. The entry TOPS is only valid for tables CTRTE, FARTE, FTRTE, OFCRTE, and PXRTE when RTESEL is set to T. The entry TOPS is not valid for table AMRTE or ACRTE.</p> <p>Note: Table OVRx must be datafilled before tables xxRTE (where xx is AC, PX, CT, FA, NSC, OFC, or FT), IBNRTE, IBNRT2, IBNRT3, IBNRT4, OFR2, OFR3, OFR4, or OFRT.</p>
	INDEX	numeric (0 to 1023)	<p>Route reference index. If the entry in refinement TABNAME is any entry other than IRTE, RRTE, or TOPS datafill this subfield.</p> <p>Enter the index of the route table (0 to 1023) to which the call is routed.</p>
	XLASYS	AC, AM, CT, FA, FT, NSC, OFC, PX	<p>Translation system. If the entry in refinement TABNAME is IRTE, datafill this subfield. Enter the translation system to which the call is transferred.</p> <p>Note: NIL is not a valid entry. NIL is used only to satisfy internal software functionality.</p>

ACRTE (continued)**Field descriptions for conditional datafill (Sheet 2 of 2)**

Field	Subfield	Entry	Explanation and action
	XLANAME	alphanumeric (1 to 8 characters)	Translation name. If the entry in refinement TABNAME is IRTE, datafill this subfield. Enter the translation name of the table instance within the XLASYS to which the call is transferred.
	RTEREF	numeric (1 to 1023)	Route reference index. If the entry in refinement TABNAME is IRTE, datafill this subfield. Enter the index of the route table specified to which the call is transferred.
	KEY	numeric (0 to 1023)	Route reference key. If the entry in subfield TABNAME is RRTE, datafill this subfield. Enter the index key of the route table to which the call is transferred.
	INDEX	alphanumeric (1 to 8 characters)	Call origination index. If the entry in subfield TABNAME is TOPS, enter the call origination index. The call origination (CO) type index entered must be datafilled in table TOPS.

Datafill example

The figure that follows shows sample datafill for table ACRTE.

MAP display example for table ACRTE

XLANAME	RTEREF	RTELIST
XLA1	555	(T OFR2 10) \$
IXLA	3	(CND NRR T IRTE PX IXLA 44) (NOT NRR ST 7) (S CLLI3) \$

The following example shows sample datafill for table ACRTE with Dynamically Controlled Routing (DCR). DCR in universal translations is controlled by SOC option DCR00004. This option can be activated either before or after the datafill of the DCR selectors in table ACRTE.

ACRTE (continued)

MAP display example for table ACRTE with DCR

XLANAME	RTEREF	RTELIST
XLA1	951	(NODE DCRNET2 NODE1 11) (N NET2_5TO4_OG NOMOD 3 974 0) (T OFR2 851) \$
XLA2	952	(NODE DCRNET2 NODE2 12) (N NET2_5TO4_OG NOMOD 3 974 0) (T OFR2 852) \$
XLA3	953	(NODE DCRNET2 NODE3 13) (N NET2_5TO4_OG NOMOD 3 974 0) (T OFR2 853) \$
XLA4	954	(DCRT DCRNET2 NODE4 14) (N NET2_5TO4_OG NOMOD 4 6211 0) (NODE DCRNET2 NODE4 14) (T OFR2 754) \$

The examples that follow show sample datafill for table PXRTE with selector SG option DMI, selector N option NBCDEF, selector GBL option CCNTRLRX, selector GBL option OUTP and selector NS.

MAP display example for table PXRTE selector SG option DMI

XLANAME	RTEREF	RTELIST
696	34	(SG CYC 10 SGRP1 (DMI 10350 \$) \$

MAP display example for table PXRTE selector N option NBCDEF

XLANAME	RTEREF	RTELIST
LNSTART	103	(N EISUPV2A NOMOD 0 NBCDEF 0) \$

ACRTE (continued)**MAP display example for table PXRTE selector GBL option CCNTRX**

XLANAME	RTEREF	RTELIST
KNGA10PX 280 (GBL CCNTRX SET_NCOS Y Y Y 123) \$		

MAP display example for table PXRTE selector GBL option OUTP

XLANAME	RTEREF	RTELIST
KNGA10PX 200 (GBL OUTP KNGA280EIBWE 5) \$		

MAP display example for table PXRTE selector NS

XLANAME	RTEREF	RTELIST
KNGA10PX 200 (NS KNGA280EIBWE 1 91 2) \$		

The MAP example below shows datafill for selectors S and SO. The first tuple only occupies 1 LISTAB element, since its only route is datafilled with the S selector which requires 1 element. The second one occupies 32 of them as it contains 8 routes, all datafilled with the SO selector which requires 4 elements. This means that the 262,080 LISTAB elements available for each xxRTE table translate into a maximum, theoretical capacity of 262,068 tuples (best case) and a minimum guaranteed capacity of 262,080 divided by 32 = 8,188 tuples (worst case).

Due to the particular way the LISTAB elements are allocated for new tuples, not all the available elements can be used and therefore when the table reaches its maximum capacity, there are still some unused tuples. This explains why a maximum of 262,068 tuples can be datafilled in each table and not 262,080.

ACRTE (continued)

MAP display example for table ACRTE selector S and SO

XLANAME	RTEREF	RTELIST
KNGAPX	998	(S KNGA1020EIBWE) \$
KNGAPX	999	(SO KNGA1020EIBWE 2 0 1628 (LONGHAUL) (SETCDN ETSIV1) \$) (SO KNGA1022EIBWE 2 0 1628 (LONGHAUL) (SETCDN ETSIV1) \$) (SO KNGA1024EIBWE 2 0 1628 (LONGHAUL) (SETCDN ETSIV1) \$) (SO KNGA1026EIBWE 2 0 1628 (LONGHAUL) (SETCDN ETSIV1) \$) (SO KNGA1028EIBWE 2 0 1628 (LONGHAUL) (SETCDN ETSIV1) \$) (SO KNGA1030EIBWE 2 0 1628 (LONGHAUL) (SETCDN ETSIV1) \$) (SO KNGA1032EIBWE 2 0 1628 (LONGHAUL) (SETCDN ETSIV1) \$) (SO KNGA1034EIBWE 2 0 1628 (LONGHAUL) (SETCDN ETSIV1) \$) \$

MAP display example for table ACRTE selector SG

XLANAME	RTEREF	RTELIST
TEST1	2	(SG CHCL 5 TEST1 (CALLTYPE PUB NONE 0 N) \$) \$

For additional route table examples, refer to table ACHEAD.

Table history

SN05

The maximum size of the Universal Routing Tables (xxRTE) is increased by activity 59034727. The change applies only if the corresponding feature “LISTAB pool expansion for UXL A tables” is activated by the use of the SOC. If the SOC is not activated, then the maximum size of the tables remains unaffected from that specified for previous releases.

NA017

The SG selector is extended to include a CALLTYPE field that permits customers to select a PUBLIC, PRIVATE, WATS, ASDS, LDS, Foreign eXchange, TIE, or INWATS calltype per feature activity 59035336.

SN04 (DMS)

Added 'N' selector (NS) and global selector (GBL) to all the routing tables for activity 59028782.

MMP16

Added explanation in routing selector option N subfield PFXDIGS for digit 'N' to be datafilled that represents digit 'A' in Universal translations for activity 59028026.

MMP15

OVRx was added as an entry to subfield TABNAME.

MMP14

Added subfield OPTIONS and option DMI for the SG selector.

MMP13

Added SETCDN to OPTIONS subfield for SO selector.

EUR008

Added routing selector option SG to subfield RTESEL.

EUR006

The SO option indicating the LONGHAUL routing option was added to subfield RTESEL.

TL07

DCR selectors DCRT and NODE were added as entries to subfield RTESEL.

ACSCALL

Table name

Attendant Speed Calling Table

Functional description

Table ACSCALL contains all speed call numbers that are stored in the cells of attendant speed call lists. This table provides a mechanism for the restoration of attendant speed call lists after a dump and restore procedure.

Speed call numbers in table ACSCALL can be added, deleted, updated, or displayed using the table editor. In addition, speed call numbers can be entered using speed call programming on the attendant console (AC) through the use of a speed call key or wildcard key. All speed call numbers that are programmed using the AC appear in table ACSCALL.

If the table editor or AC speed call programming is used to change a particular speed call cell, any number previously stored in that cell is overwritten.

Each tuple in table ACSCALL consists of a key and a corresponding speed call number. If there is no number stored against a particular key (so that the speed call cell is empty), the tuple that the key identifies does not appear in the table.

Every speed call cell is uniquely identified by the ACSCALL table key. For speed call cells accessed through a speed call function key, the table key consists of the console common language location identifier (CLLI), the key type (SC10, SC30, SC50, or SC70), and the speed call cell number (speed call code). For speed call cells accessed through a wildcard key, the table key consists of the console CLLI, the key type (WC), the wildcard code through which the speed call is accessed, and the speed call code.

Datafill sequence and implications

The following tables must be datafilled before table ACSCALL:

- ATTCONS
- WCKCODES

Table size

0 to 198 000 tuples

Table size is determined by the number of cells in attendant speed call lists that have speed call numbers stored in them. Table ACSCALL grows and shrinks as speed call numbers are added to and deleted from speed call cells.

ACSCALL (continued)**Datafill**

The following table lists datafill for table ACSCALL.

Field descriptions (Sheet 1 of 2)

Field	Subfield or refinement	Entry	Explanation and action
KEY		see subfields	<i>Acscall table ke</i> This field consists of subfields CONSOLE and SC_LIST.
	CONSOLE	alphanumeric (up to 16 characters)	<i>Console CLLI</i> Enter the common language location identifier (CLLI) code assigned to the attendant console (AC) in table ATTCONS.
	SC_LIST	see subfield	<i>Speed calling list</i> This subfield consists of subfield KEYTYPE.
	KEYTYPE	SC10, SC30, SC50, SC70, or WC	<i>Key type</i> Enter the type of key used to access the speed call list. The WC key is a special function key through which a speed call list is accessed. The SC10, SC30, SC50, and SC70 keys are special function keys that are assigned to a speed call list with a specific length, as indicated by the number following SC. For example, SC30 has a list length of 30. If an SC10, SC30, SC50, or SC70 key type is specified, datafill refinement SCCODE only. If a WC key type is specified, datafill refinements SCCODE and WCCODE.

ACSCALL (continued)

Field descriptions (Sheet 2 of 2)

Field	Subfield or refinement	Entry	Explanation and action
	SCCODE	0 to 69	<p><i>Speed call code</i> Enter the code that identifies the speed call cell within the speed call list.</p> <p>If the entry in subfield KEYTYPE is SC10, the range of speed call codes is 0 to 9.</p> <p>If the entry in subfield KEYTYPE is SC30, the range of speed call codes is 0 to 29.</p> <p>If the entry in subfield KEYTYPE is SC50, the range of speed call codes is 0 to 49.</p> <p>If the entry in subfield KEYTYPE is SC70, the range of speed call codes is 0 to 69.</p> <p>If the entry in subfield KEYTYPE is WC, check table WCKCODES for the entry in field WCSPFN. Field WCSPFN can have a value of SC10, SC30, SC50, or SC70. The range of speed call codes is determined in the manner shown above, with the field WCSPFN value used to determine the range.</p>
	WCCODE	0 to 99	<p><i>Wildcard code</i> If the entry in field KEYTYPE is WC, enter the wildcard code through which the speed call list is accessed. Otherwise, leave this field blank.</p>
SCDIGITS		numeric(0 to 24 digits)	<p><i>Speed call digits</i> Enter the speed call number stored in the specified speed call cell. The speed call number can be up to 24 digits long and can have an asterisk at the end.</p>

Datafill example

The following example shows sample datafill for table ACSCALL.

Attendant console BNRMC1 has a speed call list with a length of 70. Speed call code 55 identifies the speed call cell, which contains the number 68888204*.

Attendant console BNRMC1 also has a wildcard key for the speed call list. The wildcard key, through which the speed call list is accessed, is 20. Speed

ACSCALL (end)

call code 04 identifies the speed call cell, which contains the number 92267890.

MAP display example for table ACSCALL

		KEY	SCDIGITS
BNRMC1	SC70	55	68888204*
BNRMC1	WC 20	04	92267890

Table history**BCS36**

Added subfield SC_LIST. Shortened explanation of entries in subfield KEYTYPE.

ACTCTL

Table name

The XPM Activity Controller Table

Functional description

The CCITT Signaling System R2 uses register signaling to transfer information about a call between two ends of a trunk. The R2 systems are multifrequency compelled (MFC) systems. The R2 systems sends tones in one direction and return acknowledgement tones. A protocol specification describes the information transferred.

The R2 signaling applies to the DMS-100, DMS-200, and DMS-100/200 switches.

Table ACTCTL defines the R2 activities for a protocol that includes control of the extended multiprocessor system (XMS)-based peripheral module (XPM) processor targets and phase changes.

Each protocol has two ACTCTL tuples entered. The tuples provide signaling control. One tuple is for incoming trunks. The other tuple is for outgoing trunks.

The central control maintains and downloads table ACTCTL for NT-40. The DMS-core maintains and downloads table ACTCTL for SuperNode. The XPM uses table ACTCTL.

A group of an R2 activity and a character string index table ACTCTL. The character string corresponds to the set of incoming and outgoing signals that table R2PROT uses.

Datafill sequence and meaning

You do not have to enter data in other tables before you enter data in table ACTCTL.

Table size

0 to 7680 tuples

The table allocates a maximum of 256 tuples for each variant activity to control task mapping. Each office can have a maximum of 30 defined mappings.

ACTCTL (continued)**Datafill**

Datafill for table ACTCTL appears in the following table.

Field descriptions (Sheet 1 of 2)

Field	Subfield or refinement	Entry	Explanation and action
INDEX		see subfields	<i>Index.</i> This field contains subfields CTRLNAME and ACTIVITY. This field represents the index to table ACTCTL.
	CTRLNAME	alphanumeric (1 to 8 characters)	<i>Controller name.</i> Enter the controller name.
	ACTIVITY	alphanumeric (to a maximum of 18characters)	<i>R2 activity.</i> Enter the name of the R2 activity. See table SIGACT for the list of activity entries.

ACTCTL (continued)

Field descriptions (Sheet 2 of 2)

Field	Subfield or refinement	Entry	Explanation and action
RSTPRCID		GENERAL NO_ CHANGE IC01_DGT IC01_ANI OG01_DGT OG01_ANI IC01_SOC IC02_DGT OG01_SOC OG02_DGT IC02_SOC OG02_ANI IG03_ANI IC02_ANI or OG01_REQ	<i>Register signaling transactor processor identification.</i> Enter the register signaling transactor (RST) state processor code.
PHASE		NO_ CHANGE PHASE_0 PHASE_1 PHASE_2 PHASE_3 PHASE_4 PHASE_5 PHASE_6 PHASE_7 PHASE_8 PHASE_9 PHASE_10 PHASE_11 PHASE_12 PHASE_13 or PHASE_14	<i>R2 phase.</i> Enter the phase to change to after the activity completes.

Datafill example

Sample datafill for table ACTCTL appears in the following example.

ACTCTL (end)**MAP example for table ACTCTL**

INDEX	RSTPRCID	PHASE
BELCTLI DIGIT_1	NO_CHANGE	NO_CHANGE
BELCTLI DIGIT_2	NO_CHANGE	NO_CHANGE
BELCLTO REGULAR	NO_CHANGE	PHASE_2

Table history**BCS34**

Table ACTCTL was introduced in BCS34.

Additional information

This section provides information on datafilling table ACTCTL for specified applications. This section provides product description information that relates to table ACTCTL.

Enter each R2 activity in table ACTCTL to define the R2 activity for a specified protocol. The exception to this rule is activity LAST_DIGIT. When LAST_DIGIT appears against the incoming ACTCTL index of that protocol, the system records LAST_DIGIT as defined and correct for a protocol.

If a protocol requires an identical mapping already entered, do not define a new tuple. More than one protocol can use the ACTCTL index.

ACTGEN

Table name

Multifrequency Compelled Activity Generator Table

Functional description

Table ACTGEN contains an original activity and two additional activities. The original activity generates the two additional activities.

The system performs some incoming logical activities in more than one signal transmission. One activity can generate the two logical activities. The system performs the activities in sequence.

For example, an incoming trunk must report idle change after the reception of the digits. The incoming trunk must send a B category signal followed by an idle charge signal.

You can enter additional logical incoming activities in this table (Term_req, Tran_req). These activities are the first activities the system performs on the incoming trunk.

The table structure is:

INDX (orig_act_1 act1 act2) . . . (orig_act_n act1 act2)

Note: Table ACTGEN has protection. The operating company cannot update table ACTGEN.

See table MFCPROT for additional information.

Datafill sequence and meaning

You do not have to enter data in other tables before you enter data in table ACTGEN.

Table size

0 to 3 tuples

ACTGEN (continued)**Datafill**

Datafill for table ACTGEN appears in the following table.

Field descriptions

Field	Subfield or refinement	Entry	Explanation and action
INDX		1 to 3	<i>Index.</i> This field is the index to the tuple. Field ACTGEN in table MFCPROT references this field.
ACTGEN		see subfields	<i>Activity generation.</i> This field is a vector that contains a maximum of 23 multiples of subfields ORIG_ACT, ACT1, and ACT2. If less than 23 multiples are required, end the list with a \$ (dollar sign).
	ORIG_ACT	alphanumeric (1 to 18 characters)	<i>Original activity.</i> This field contains the name of the original activity.
	ACT1	alphanumeric (1 to 18 characters)	<i>First generated activity.</i> This field contains the name of the first activity that the original activity generates.
	ACT2	alphanumeric (1 to 18 characters)	<i>Second generated activity.</i> This field contains the name of the second activity that the original activity generates.

Datafill example

Sample datafill for table ACTGEN appears in the following example.

ACTGEN (end)

MAP example for table ACTGEN

INDX	ACTGEN
1	DNCHANGED BCATEGORY DNCHANGED SUBSBUSY BCATEGORY SUBSBUSY CONGESTION BCATEGORY CONGESTION IDLECHRG BCATEGORY IDLECHRG IDLENCHRG BCATEGORY IDLENCHRG OUTOFORD BCATEGORY OUTOFORD TERMREQ ESUPREQ CKTTYPE TRANREQ CKTTYPE DUMMYACT \$

ACTMFC**Table name**

Multifrequency Compelled Activity to Signal Translation Table

Functional description

Table ACTMFC defines the multifrequency compelled (MFC) signal for every MFC activity. Each tuple defines signals for one phase.

Field ACTMFC is a vector of pairs of MFC activities and MFC signals for a phase. When an activity is not present, table ACTMFC does not define the activity for this phase. Table ACTMFC is not the direct opposite of table MFCACT because table ACTMFC can recognize and accept some signals. The system never sends signals. Tables MFCACT and ACTMFC do not have to be consistent with each other. Tables MFCACT and ACTMFC must be consistent with the far end protocol.

See table MFCPROT for additional information.

Note: This table has protection. The operating company cannot update this table.

Datafill sequence and meaning

You do not have to enter data in other tables before you enter data in table ACTMFC.

Table size

15 tuples

Datafill

Datafill for table ACTMFC appears in the following table.

Field descriptions (Sheet 1 of 2)

Field	Subfield or refinement	Entry	Explanation and action
INDX		1 to 15	<i>Index.</i> This field contains a number from 1 to 15 as the index to the tuple. Fields ICACT and OGACTION in table MFCPROT reference this field.
PHASE		I, II, A, B, C, D	<i>Protocol phase.</i> This field contains the protocol phase for this tuple.

ACTMFC (continued)

Field descriptions (Sheet 2 of 2)

Field	Subfield or refinement	Entry	Explanation and action
ACTMFC		see subfields	<p><i>Vector pairs of MFC activity and MFC signal.</i> This field contains subfields ACTIVITY and SIGNAL.</p> <p>This field contains a mapping between the activities and the signals sent for a specified phase. The first part of the vector element pair is the MFC activity. An example of the first part of the vector element pair is DIGIT1 and ICPOPR. The second part of the vector element pair is phased together with one of the 15 tones. An example is I1 and I15.</p> <p>The vector contains a maximum of 32 pairs of MFC signal and MFC activity. If less than 32 pairs are required, end the list with a \$ (dollar sign).</p> <p>An activity cannot appear more than one time in any one vector.</p>
	ACTIVITY	alphanumeric (1 to 8 characters)	<i>Multifrequency compelled activity.</i> This field contains the MFC activity.
	SIGNAL	A1 to A15, B1 to B15, C1 to C15, D1 to D15, I1 to I15, II1 to II15	<i>Multifrequency compelled signal.</i> This field contains the MFC signal. For example, the entry in field PHASE is D. The entries in field SIGNAL can range from D1 to D15.

Datafill example

Sample datafill for table ACTMFC appears in the following example.

ACTMFC (end)

MAP example for table ACTMFC

INDX	PHASE	ACTMFC
7	I	(DIGIT1 I1) (DIGIT2 I2) (DIGIT3 I3) (DIGIT4 I4) (DIGIT5 I5) (DIGIT6 I6) (DIGIT7 I7) (DIGIT8 I8) (DIGIT9 I9) (DIGIT0 I10) (ECSUPREQ I13) (SAT I3) (NOSAT I2) (ORDSUBSC I4) (TESTEQ I3) (NUMUNAVAIL I15) \$

Table history
BCS36

Subfields ACTIVITY and SIGNAL were added in BCS36.

ACTPATCH

Table name

Activatable Patches

Functional description

Table ACTPATCH displays the status of all computing module (CM) applied activatable patches. This table is a read-only table. You cannot add tuples to this table. You cannot delete tuples from this table. You cannot change the tuples in this table. This table is a requirement during the One Night Process (ONP).

Use the PATCHEDIT/SELECT command to find the status of all activatable patches. Table ACTPATCH changes as PATCHEDIT/ASSIGN changes the status of patches.

This table interacts with PATCHER/PRISM.

Datafill sequence and implications

You do not have to enter data in other tables before you enter data in table ACTPATCH.

Table size

Does not apply

Datafill

Datafill for table ACTPATCH appears in the following table.

Field descriptions

Field	Subfield or refinement	Entry	Explanation and action
PATCHID		alphanumeric (vector of a maximum of 32 characters)	Patch identification. This field displays all activatable patches. The patch identifications are a maximum of 32 characters in length.
STATUS		OFF, ON or NA	Status. This field displays the status of all CM activatable patches. Possible entries include OFF, ON and NA (no audit).

Datafill example

Sample datafill for table ACTPATCH appears in the following example.

ACTPATCH (end)

MAP example for table ACTPATCH

	PATCHID	STATUS
VAB05B34		ON
AMC85B34		ON

Table history**CSP04**

This read-only table was introduced to meet information requirements for the ONP in CSP04.

ACTSIG

Table name

XPM Activity to Signal Mapping Table

Functional description

The CCITT Signaling System R2 (R2) uses register signaling to transfer call information between two ends of a trunk. The R2 systems are multifrequency compelled (MFC) systems that send tones in one direction on a trunk link. Acknowledgment tones return in the opposite direction on the trunk link. A protocol specification describes the information that transfers.

The R2 signaling systems apply to DMS-100, DMS-200, and DMS-100/200 switches.

Table ACTSIG maps R2 activities to facility signals (MFC tones) for each phase of a protocol. The system accesses table ACTSIG before the system sends a signal to another office.

Each protocol has a number of ACTSIG tuples entered to provide activity-to-signal mapping. Each phase of a protocol in table R2PROT has one set of tuples with the same value defined in field TUPLENO.

The following features maintain and download table ACTSIG:

- central control (for NT-40)
- DMS-core (for SuperNode)

The extended multiprocessor system (XMS)-based peripheral module (XPM) uses this table.

An index from table R2PROT, and an activity identifier references table ACTSIG.

See table ACTCTL for additional information.

Datafill sequence and meaning

You do not need to enter data in other tables before you enter data in table ACTSIG.

Table size

0 to 32 767 tuples

Each variant activity requires a maximum of 256 tuples to signal mapping. Each office can contain a maximum of 256 variant mappings.

ACTSIG (continued)**Datafill**

The datafill for table ACTSIG appears in the following table.

Field descriptions

Field	Subfield or refinement	Entry	Explanation and action
INDEX		see subfields	<i>Index.</i> This field contains subfields TUPLENO and ACTIVITY. This field is the index to table ACTSIG.
	TUPLENO	numeric (1 to 255)	<i>Tuple number.</i> Enter the tuple number. The entry 0 (zero) is reserved for the NIL tuple. Only the DMS software uses this tuple.
	ACTIVITY	alphanumeric (1 to 18 characters)	<i>R2 activity.</i> Enter the name of the R2 activity. See table SIGACT for the list of activity entries.
SIGNAL		numeric (1 to 15)	<i>Signal.</i> Enter the signal number.

Datafill example

Sample datafill for table ACTSIG appears in the following example.

MAP example for table ACTSIG

INDEX	SIGNAL
0 CONGESTION	3
0 UNASSIGN_NUM	5
0 SUBBUSY	1
1 CONGESTION	3
1 UNASSIGN_NUM	5
1 SUBBUSY	1

Table history**BCS34**

Table ACTSIG was introduced in BCS34.

ACTSIG (end)

Additional information

The following information appears in this section:

- how to enter table ACTSIG for specified applications
- product description information related to table ACTSIG.

R2 activities

You must enter each R2 activity in table ACTSIG to identify the activity. This action identifies each activity as a correct signal to generate for a protocol. The system generates these signals for each phase of activity. This rule applies to incoming and outgoing trunks.

Mapping required by protocol

A protocol can require mapping that is identical to a mapping already entered. When this condition occurs, do not enter a new tuple. More than one protocol can use the ACTSIG index.

ACTSNBEC

Table name

Automated Coin Toll Service Non-Bell Exchange Carrier Table

Functional description

In central office switches that provide operator services for non-Bell exchange carriers (NBEC), the "thank you" announcement for the first Automated Coin Toll Service (ACTS) coin request is the only announcement that can be customized by the operating company since it is only used on the initial subscriber call.

Table ACTSNBEC enables customization of the initial "thank you" message by using an index to identify each specific NBEC. This index allows each NBEC to have unique announcements for the correct deposit by the coin subscriber and for an over-deposit by a coin subscriber on a coin phone serviced by ACTS.

For related information, refer to table ANNS and DRMUSERS.

Datafill sequence and implications

The following tables must be datafilled before table ACTSNBEC

- ANNS
- DRMUSERS

Table size

0 to 40 tuples

If table ACTSNBEC does not have an index for a particular NBEC, the default initial "thank you" announcements are made using ACTSTOPS 4 for correct deposit and ACTSTOPS 5 for over-deposit in table DRMUSERS.

Datafill

The following table lists datafill for table ACTSNBEC.

Field descriptions (Sheet 1 of 2)

Field	Subfield or refinement	Entry	Explanation and action
NBECCODE		up to 4 digits (0 to 9)	Non-Bell exchange carrier code. Enter a number for a non-Bell carrier (NBEC).
CORRECTDP		see subfields	Correct deposit announcement. This field consists of subfields CLLI and ANNUM.

ACTSNBEC (end)

Field descriptions (Sheet 2 of 2)

Field	Subfield or refinement	Entry	Explanation and action
OVERDEP	CLLI	alphanumeric (1 to 16 characters)	Common language location identifier. Enter a common language location identifier (CLLI) for the automated coin toll service (ACTS) correct deposit announcement. The CLLI must be datafilled in table ANNS before table ACTSNBEC.
	ANNUM	1 to 255	Announcement number. Enter the index for the ACTS announcement. The index must be datafilled in table DRMUSERS before table ACTSNBEC.
		see subfields	Over-deposit announcement. This field consists of subfields CLLI and ANNUM.
	CLLI	alphanumeric (1 to 16 characters)	Common language location identifier. Enter a CLLI for the ACTS over-deposit announcement. The CLLI must be datafilled in table ANNS before table ACTSNBEC.
	ANNUM	1 to 255	Announcement number. Enter the index for the ACTS announcement. The index must be datafilled in table DRMUSERS before table ACTSNBEC.

Datafill example

The following example shows sample datafill for table ACTSNBEC.

MAP display example for table ACTSNBEC

NBECCODE	CORRECTDP	OVERDEP
1386	ACTSTOPS 22	ACTSTOPS 23

ACTSOPTS

Table name

Automatic Coin Toll Service Optional Timeout Parameters Table

Functional description

Table ACTSOPTS supports the Automatic Coin Toll Service (ACTS). The ACTS system resides in the DMS-200 switch and handles coin toll traffic routed from the DMS-100 end office. Feature ACTS uses coin detection circuits (CDC) to detect coin tones generated by coin phone tone generation circuits, which are triggered by the deposit of coins. A digital recorded announcement machine (DRAM) provides announcements for the automated voice interface to the calling party.

For more information on ACTS, see table TOPS.

Datafill sequence and implications

There is no requirement to datafill other tables prior to table ACTSOPTS.

Table size

0 to 10 tuples

This is a static table of 16 words.

All parameters require a restart to initialize with the exception of ACTS_COIN_TEST_TIME_OUT; CHARGE_DUE_TIMEOUT; COLLECT_TIME; and INITIAL_TIMEOUT.

Datafill

The following table lists datafill for table ACTSOPTS.

Field descriptions (Sheet 1 of 2)

Field PARMNAME	Field PARMVAL	Explanation and action
ACTS_COIN_TEST_TIME_OUT	1 to 60	Enter ACTS_COIN_TEST_TIME_OUT to set the length of time in seconds the test waits after the end of a prompt for a deposit before determining that the test has failed. The default value is 4 (seconds).
CHARGE_DUE_ANNOUNCEMENT_DELAY	0 to 3600	Enter CHARGE_DUE_ANNOUNCEMENT_DELAY to set the amount of time in seconds between initial announcements. The default value is 5 (seconds).

ACTSOPTS (continued)

Field descriptions (Sheet 2 of 2)

Field PARMNAME	Field PARMVAL	Explanation and action
CHARGE_ DUE_TIME-OUT	0 to 3600	Enter CHARGE_DUE_TIMEOUT to set the time-out duration in tenths of seconds for charge due contacts. The default value is 80 (tenths of seconds).
COLLECT_TIME	0 to 3600	Enter COLLECT_TIME to set the maximum amount of coin collection time in seconds allowed on a recalls automatic coin toll service (ACTS) call. The default value is 32 (seconds).
INITIAL_ ANNOUNCEMENT_ DELAY	0 to 3600	Enter INITIAL_ANNOUNCEMENT_DELAY to set the amount of time in seconds between initial announcements. The default value is 5 (seconds).
INITIAL_TIMEOUT	0 to 3600	Enter INITIAL_TIMEOUT to set the time-out duration in tenths of seconds for initial ACTS contacts. The default value is 55 (tenths of seconds).
RING_BACK_ANS_ DELAY	0 to 3600	Enter RING_BACK_ANS_DELAY to set the amount of delay in seconds needed for the customer to pick up the receiver on a ringback answer. The default value is 1 (second).
RING_BACK_TIME	0 to 3600	Enter RING_BACK_TIME to set the amount of time in seconds that ACTS applies ring back to the telephone on a calling party disconnect with charges due. The default value is 30 (seconds).
TAC_ ANNOUNCEMENT_ DELAY	0 to 3600	Enter TAC_ANNOUNCEMENT_DELAY to set the amount of time in seconds between two Time and Charges announcements. The default value is 3 (seconds).

Datavfill example

The following example shows sample datavfill for table ACTSOPTS.

MAP display example for table ACTSOPTS

OPTION VALUE	
INITIAL_TIMEOUT	60

Table history

BCS36

Added ACTS_COIN_TEST_TIME_OUT

Removed RING_BACK_WAIT per PRS BR39772

ACTTRTMT

Table name

Activity to Treatment Mapping Table

Functional description

The CCITT Signaling System R2 (R2) uses register signaling to transfer information about a call between the two ends of a trunk. The R2 signaling applies to the DMS-100 and DMS-200 switches.

Table control software uses the R2 activity tables. The table control software is a requirement to input the protocol specification in the DMS-100 and DMS-200 switches.

The following features use table ACTTRTMT:

- central control (NT-40 switches)
- DMS-code (SuperNode switches)

Table ACTTRTMT provides a translation from an R2 activity to an extended treatment. Outgoing R2 multifrequency compelled (MFC) signaling trunks require this table.

A treatment index (TRTMTIDX) and an activity identifier index table ACTTRTMT. The treatment index is in tables TRKGRP (selector MTR and OPR) and TRKSGRP (signaling selector FST). The activity identifier corresponds to the received signal. Table ACTTRTMT returns a treatment identifier that determines if treatment must occur in the previous or local office.

Each protocol has one ACTTRTMT tuple to provide the required mappings. If an activity is not entered in the table, the default is reorder (RODR).

A list of correct R2 activities for table ACTTRTMT appears in the following table.

Correct R2 activities for table ACTTRTMT (Sheet 1 of 2)

R2 activity	Description of activity
CONGESTION	Congestion in network
SUB_BUSY	Subscriber line is busy
SUB_OUT_ORD	Call number is out of order

ACTTRTMT (continued)**Correct R2 activities for table ACTTRTMT (Sheet 2 of 2)**

R2 activity	Description of activity
SUB_XFRD	Subscriber transferred
TEMP_OUT_ORD	Temporarily out of order
UNASSIGNED_NUM	Called number is not assigned
SUB_LBUSY	Called subscriber busy in a local call
SUB_TBUSY	Called subscriber busy in a toll call
SPARE_TRTMT1	Spare

Datafill sequence and meaning

You do not need to enter data in other tables before you enter data in table ACTTRTMT.

Table size

0 to 3840 tuples

The number of tuples you add dynamically determines the table size. Each variant signal requires a maximum of 16 tuples to perform activity mapping. You can define a maximum of 256 mappings for each office.

Datafill

The datafill for table ACTTRTMT appears in the following table.

Field descriptions (Sheet 1 of 2)

Field	Subfield or refinement	Entry	Explanation and action
INDEX		see subfields	<i>Activity index.</i> This field contains subfields TRTNAME and ACTIVITY.
	TRTNAME	alphanumeric (a maximum of 8 characters)	<i>Treatment mapping name.</i> Enter the treatment mapping name assigned to the R2 activity. Field TRTMTIDX in tables TRKGRP (selector MTR or OPR) and TRKSGRP (signaling selector FST) indexes field TRTMTIDX.

ACTTRTMT (end)**Field descriptions (Sheet 2 of 2)**

Field	Subfield or refinement	Entry	Explanation and action
TRTMT	ACTIVITY	see list in table Table , "Correct R2 activities for table ACTTRTMT" on page -414	<i>R2 activity.</i> Enter the name of the required R2 activity. See table Table , "Correct R2 activities for table ACTTRTMT" on page -414 for a complete list of correct R2 activities.
		alphanumeric (4 characters)	<i>Treatment.</i> Enter the name of the extended treatment assigned to the R2 activity. See the description of table TMTCNTL for a complete list of extended treatments.

Datafill example

Sample datafill for table ACTTRTMT appears in the following example.

MAP example for table ACTTRTMT

INDEX	TRTMT
MORTRTT CONGESTION	NBLH
MORTRTL UNASSIGNED_NUM	VACT
SOCTRRT SUB_BUSY	BUSY

ADACCOPT

Table name

Automatic Directory Assistance Call Completion Options Table

Functional description

Table ADACCOPT specifies the available billing methods for Automatic Directory Assistance (DA) Call Completion (ADACC). It also specifies the queue used for call completion re-connects when the billing method selected requires an operator, and the call type displayed to the operator on such re-connects.

For related information, refer to table DATRKOPT.

Datafill sequence and implications

The following tables must be datafilled before table ADACCOPT.

- TOPS
- SERVNAME
- TARIFF
- SCHED
- SCHEDI

Table size

Table ADACCOPT is dynamically allocated and requires 177 words of storage even if no tuples are allocated. The maximum amount of storage required is 49 442 words. Normally only 5187 words are allocated.

Datafill

The following table lists datafill for table ADACCOPT.

Field descriptions (Sheet 1 of 5)

Field	Subfield or refinement	Entry	Explanation and action
ACCKEY		see subfields	Automatic directory assistance call completion option key. This field consists of subfields COTYPE, SRVCLS and RBILNUM.
	COTYPE	alphanumeric (up to 8 characters)	Call origination. Enter the directory assistance (DA) call origination type. See table TOPS.

ADACCOPT (continued)

Field descriptions (Sheet 2 of 5)

Field	Subfield or refinement	Entry	Explanation and action
	SRVCLS	COIN HOTEL RESTRICT STATION or UNSPEC	<p>Service class. Enter the service class of the call.</p> <p>The operating company must specify a restricted billing class for service classes COIN or RESTRICT.</p> <p>If COIN or RESTRICT is entered, datafill refinement RBILNUM.</p>
	RBILNUM	0 to 100	<p>Restricted billing class number. If the entry in field SRVCLS is COIN or RESTRICTED, datafill this refinement. Enter a valid restricted billing class number as previously defined in table SPLDNID.</p> <p>Since a restricted billing class must be specified for a service class of COIN, a restricted billing class of 100 is used to specify options for coin stations that are not restricted.</p>

ADACCOPT (continued)

Field descriptions (Sheet 3 of 5)

Field	Subfield or refinement	Entry	Explanation and action
BILTYPES		ALL, ALTBIL, CONTBIL, NONE, OPERBIL, or SENTPD	<p>Billing type options. Enter a set of allowable billing type options.</p> <ul style="list-style-type: none"> • ALL (all billing types) • ALTBIL (alternate billing). Caller desires to bill call completion charges either to a calling card, to a third number, or collect. • CONTBIL (continue billing). Call completion charges billing must use billing method already established for DA portion of call. <p>Note: CONTBIL is valid only if the preceding DA call was billable which insures that a valid billing method was established. If the billing method established for the DA call was bill to third party, then the entry in field DACC_BILL_TO_THIRD in table VROPT determines if the CONTBIL option can be selected for call completion. If field DACC_BILL_TO_THIRD in table VROPT contains N, CONTBIL is not an option offered to the subscriber.</p>

ADACCOPT (continued)

Field descriptions (Sheet 4 of 5)

Field	Subfield or refinement	Entry	Explanation and action
BILTYPES (continued)			<p>Billing type options (continued). Enter a set of allowable billing type options.</p> <ul style="list-style-type: none"> • NONE (none). Retain billing method used prior to this alternate billing feature. The subscriber is not offered a selection of billing options for call completion. <p>Use of this value is changed by feature AN0262 in TOPS03. Refer to the history section for the functionality of this feature. Prior to AN0262, or if feature AN0262 is not active, specifying NONE indicates that the subscriber is not offered a selection of billing options for call completion, and that the billing approach used prior to Feature AF2086 (ADACC with Alternate Billing) is to be used. When feature AN0262 is active, value NONE indicates that no billing types are valid, except auto-collect. It is suggested that all instances of NONE be changed to either CONTBIL or SENTPD before activating feature AN0262.</p> <p>Note that NONE is still a valid entry but its use has changed in TOPS03.</p> <ul style="list-style-type: none"> • SENTPD (sent paid). Call completion charges are billed to the calling party. • OPERBIL (operator billing). The subscriber is connected to a toll operator for billing the ADACC call.
DISPLAY		see subfields	Operator display on a call completion re-connect. This field specifies the display for the call type presented to the operator on a call completion re-connect. This field consists of subfields SEL and HEADER.

ADACCOPT (continued)

Field descriptions (Sheet 5 of 5)

Field	Subfield or refinement	Entry	Explanation and action
	SEL	C or S	<p>Select display. Enter C (character) to override the standard display and datafill refinement HEADER. This value is then displayed to the operator in the call type field for an automatic DA call completion re-connect.</p> <p>Enter S (standard) to indicate that the display for the TA call type specified in table TOPS is presented.</p> <p>Note: Even though a standard display is selected in table ADACCOPT, a character display can be presented for call completion re-connects because of a character display type being specified for the TA call type in table TOPS.</p>
	HEADER	alphanumeric (up to 6 characters)	Select display. If the entry in subfield SEL is C, datafill this refinement. Enter a value for the call. The value is displayed to the operator in the call type field for an automatic DA call completion re-connect.

Datafill example

The following example shows sample datafill for table ADACCOPT.

MAP display example for table ADACCOPT

	ACKEY	BILTYPES	DISPLAY
UNSPEC	COIN 44	ALL	ALF

Table history
TOPS12

Field CCREQUE is removed by feature 59006865 in functionality MD Code Removal and ReEngineering, OSB00001.

ADACCOPT (end)

TOPS03

Feature AN0262 in Cellular/IXC/LEC ADACC, OSDA0005:

- Changed use of value NONE in field BILYPES.

Feature AN0410 in Cellular/IXC/LEC ADACC, OSDA0005:

- Added value OPERBIL in field BILYPES.

ADJNODE**Table name**

Adjacent Node

Functional description

Table ADJNODE contains information about the type of software running in an adjacent node.

**CAUTION****Potential call failure**

If the setup method is used for the Calling Name Delivery feature, the calling name information is sent in an optional field of the initial address message (IAM). If a trunk group to a GTD5 is datafilled with an adjacent node type of DMS switch in table ADJNODE, calls over that trunk group fail because the other node does not recognize the IAM.

Datafill sequence and meaning

Enter datafill into table TRKGRP before table ADJNODE.

Table size

0 to 16 384 tuples

Datafill

The table that follows lists datafill for table ADJNODE.

Field descriptions (Sheet 1 of 5)

Field	Subfield	Entry	Explanation and action
ADJNODEK		alphanumeric (up to 12 characters)	<i>Adjacent node key</i> Enter the adjacent node key. Choose a name that clearly identifies the applicable office.
<p>Note: The primary rate access (PRA) tuple in this table is no longer required; variant and issue information is now sent from table LTDEF. However, the PRA field selector is not deleted; it must be preserved to allow the transparent transfer of information in this table to table LTDEF during a BCS application. Therefore, the user does not see PRA tuples in table ADJNODE. If an attempt is made to add a PRA tuple to this table, the following error message is displayed.</p> <p>PRA tuples cannot be entered. PRA information is now contained solely in table LTDEF. The PRA field is preserved to allow transparent transfer of PRA information between tables ADJNODE and LTDEF during a BCS application.</p>			

ADJNODE (continued)

Field descriptions (Sheet 2 of 5)

Field	Subfield	Entry	Explanation and action
SIGDATA		ISUP	<p><i>Signaling type data</i> Specify the type of signaling that is performed on each trunk subgroup connected with the site.</p> <p>Enter ISUP for ISDN user part and datafill field SIGDATA and subfields PRODUCT and OPTIONS.</p>
SIGDATA		see subfields	<p><i>Signaling data</i> This field consists of subfields PRODUCT and OPTIONS. OPTIONS consist of: AUTOCON, BLUEBOOK, NOCQT, NOGRPBLK, NOCVT, NOJIP, NON-ACDNTP, NON-STDREDIR, NOPNET, NOVNET, and SPN.</p>
	PRODUCT	BELLCORESTDD EX, DMS, DMSISN, DMSNCS, DMS250, DMS300, DSC, ERICSSON, ESS1A, ESS4, ESS5, FUJITSU, GTE, IBMROLM, NEC, ROCKWELL, SIEMENS, SL1, SL100, STROMBER-GC ARLSON, SYSTEMX, SYS85 AUSTPRA, ETSIPRA, INS1500, or OTHER	<p><i>Product type</i> Enter the type of product that is in the adjacent switch.</p> <p>If the entry in field SIGDATA is ISUP, enter any of the values in the PRODUCT column and datafill refinement PRODUCT.</p> <p>If the entry in subfield PRODUCT is BELLCORESTD, no further datafill is required.</p> <p>If PROTOCOL is datafilled as Q767 and VERSION is datafilled as 100_WHITE in table TRKSGRP, datafill subfield PRODUCT in table ADJNODE as OTHER.</p>

ADJNODE (continued)

Field descriptions (Sheet 3 of 5)

Field	Subfield	Entry	Explanation and action
	OPTIONS	AUTOCON BLUEBOOK NOCQT NOGRPBLK NOCVT NOJIP NON-ACDNTN NON-STDREDIR NOPNET NOVNET SPN DONTSENDACL INHIBITACL	<p><i>ISDN user part option elements</i></p> <p>Enter up to 32 of the following options. If fewer than 32 options are required, end the list with a \$ (dollar sign).</p> <p>Enter AUTOCON for automatic congestion control enabled. This requires feature package NTXK95AA, Automatic Congestion Control.</p> <p>Enter BLUEBOOK for CCITT blue book applicable. This requires the ISDN - Primary Rate Access Base feature in package NTX790AC (CCITT Blue Book Conformance - PRA).</p> <p>Enter NOCQT for circuit query test disabled.</p> <p>Enter NOGRPBLK for circuit group blocking disabled.</p> <p>Enter NOCVT for circuit validation testing disabled.</p> <p>Enter NOJIP for no jurisdiction information parameter. This disables the signaling of the jurisdiction information parameter (JIP) to the adjacent node. (With this option applied to the tuple, ISUP trunks outgoing to the corresponding adjacent node will not populate the JIP when LNP is active in the switch.) This option only applies to tuples with a SIGDATA value of ISUP.</p>

ADJNODE (continued)**Field descriptions (Sheet 4 of 5)**

Field	Subfield	Entry	Explanation and action
0	OPTIONS (continued)		<p>Enter NONACDNTP for network automatic call distribution (NACD) network transport parameter (NTP) not supported. This requires feature package NTXN46AA, Networked ACD on CCS7.</p> <p>Enter NONSTDREDIR for nonstandard redirection indicator. Option NONSTDREDIR is valid only if the switches connected to the switch being datafilled are DMS or NEC switches.</p> <p>Enter NOPNET for switch computer application interface (SCAI) private network (PNET) parameter not supported. This requires feature package NTXL32AA, Custom Private Network Enhancements for SCAI Type III.</p> <p>Enter NOVNET for MCI virtual network not supported. This requires feature package NTXL32AA, Custom Private Network Enhancements for SCAI Type III).</p> <p>Enter SPN for signal ported number. This enables the signaling of the ported number to the adjacent node. (With this option applied to the tuple, ISUP trunks outgoing to the corresponding adjacent node will populate the original dialed number (ported number) for all LNP calls.) This option only applies to tuples with a SIGDATA value of ISUP.</p>

ADJNODE (continued)**Field descriptions (Sheet 5 of 5)**

Field	Subfield	Entry	Explanation and action
	OPTIONS (continued)		<p>Enter DONTSENDACL to control when the ACL parameter is populated in the ISUP REL message in the congested office.</p> <p>Note: In gateway offices, option AUTOCON is used in place of DONTSENDACL. This is to maintain current AUTOCON functionality.</p> <p>Enter INHIBITACL to block the processing of the ACL parameter on a node level. This option is applied to the switch that receives the ACL parameters from the CCS7 network. Network Management Preplans are not allowed if ACLs are not processed.</p> <p>The default for this field is no options.</p>

Datafill example

The figure that follows shows sample datafill for table ADJNODE.

MAP display example for table ADJNODE

ADJNODEK	SIGDATA		SIGDATA
<hr/>			
DMSNODE	ISUP	DMS	NOVNET

The following example shows sample datafill for table ADJNODE with options SPN and NOJIP.

ADJNODE (end)

MAP display example for table ADJNODE options SPN and NOJIP

ADJNODEK		SIGDATA	
		SIGDATA	
DMS31	ISUP	DMS	(SPN) \$
DMS31	ISUP	DMS	(NOJIP) \$

The following example shows sample datafill for table ADJNODE with options DONTSENDACL and INHIBITACL.

MAP display example for table ADJNODE options DONTSENDACL and INHIBITACL

ADJNODEK		SIGDATA	
		SIGDATA	
DMS31	ISUP	DMS	(DONTSENDACL) \$
DMS31	ISUP	DMS	(INHIBITACL) \$

Table history

NA008

Added options DONTSENDACL and INHIBITACL.

NA007

Added Local Number Portability (LNP) options NOJIP and SPN.

BCS36

The following changes were implemented:

- Datafill sequence was corrected.
- A note was added to subfield PRODUCT for entry PRA.
- A note was added to subfield OPTIONS for entry NONSTDREDIR.
- A warning was added about call failures on trunk groups to a GTD5.

AGGREINT

Table name

Frame Relay Service Aggregate Billing Interval Table

Functional description

Table AGGREINT provides the timing mechanism for generating billing records for frame relay service (FRS) data transmission usage by operating company customers.

FRS is a data transmission service that eliminates the need for dedicated link facilities for data transmission. The public switching network allows the operating company to uniquely define an FRS customer and bill them on a usage basis only.

Usage based billing is flexible as dedicated facilities are no longer required and the operating company can tailor usage billing through table AGGREINT.

Table AGGREINT allows the definition of a billing start time and a billing accumulation or aggregation time that is unique to each operating company customer. When the aggregation interval is past, a billing record summary is sent to the FRS database. The FRS database creates the billing information that is sent to the customer.

For related information, refer to table PVDNCUST.

Datafill sequence and implications

Table PVDNCUST must be datafilled before table AGGREINT.

Table AGGREINT is datafilled when a customer name is added into table PVDNCUST. The table can only be changed, it cannot have data directly added to it or directly deleted from it. Each customer name added to PVDNCUST creates an entry with the same customer name in table AGGREINT. Default start and interval times are also added to table AGGREINT. If a customer name is deleted from table PVDNCUST, it is automatically deleted from table AGGREINT.

Table size

0 to 1000 tuples

AGGREINT (continued)**Datafill**

The following table lists datafill for table AGGREINT.

Field descriptions

Field	Subfield or refinement	Entry	Explanation and action
CUSTKEY		alphanumeric (1 to 20 characters)	<i>Customer name key</i> The customer name is automatically added when a customer name is added in table PVDNCUST. Customer names cannot be directly added to table AGGREINT.
STARTIME		0 to 23	<i>Billing record start time</i> Enter the time of day, on the 24-h clock, that the operating company customer requires the billing record to begin. The first billing record is generated in the first hour following the time entered in this field. The default value is 5 (0500 h).
INTERVAL		1 to 336	<i>Billing aggregation interval</i> Enter the required customer billing aggregation interval. This represents the amount of time that billing records are accumulated, or aggregated, before being sent to the frame relay service (FRS) billing database for processing. The interval is expressed in half-hour increments. For example, the interval value of 96 represents an aggregation interval of two days. The default value is 48, or one day.

Datafill example

The following example shows sample datafill for table AGGREINT.

Customer ABCPrinting has billing recording starting at 0400 h. The aggregation interval is 56, or 28 h.

MAP display example for table AGGREINT

CUSTKEY	STARTIME	INTERVAL
ABCPRINTING	4	56

AINANNS

Table name

Advanced Intelligent Network Announcement Table

Functional description

Table AINANNS is used as a mapping table to identify Systems Announcement Identifiers to a DMS internal announcement in table DRMUSERS. The System Announcement Identifier is a 2-byte integer (field ANNNUM), which is mapped to an index into table DRMUSERS. Table DRMUSERS is indexed by a common language location identifier (field CLLI) and an announcement member number (field ANNNUM).

Tuples in this table must reference existing tuples in table DRMUSERS. Tuples in table DRMUSERS cannot be deleted if they are referenced in table AINANNS. All tuples added to table AINANNS must have a corresponding tuple in table ANNS, with the same CLLI and field ANTYPE set to AIN or STND.

Datafill sequence and implications

The following tables must be datafilled before table AINANNS:

- CLLI
- ANNS
- DRMUSERS
- ANNMEMS

DMS-100 SSP standard announcements are datafilled in table ANNS and are mapped to the system announcement ID in table AINANNS. DMS-100SSP customized announcements are datafilled in tables ANNS and DRMUSERS and are mapped to the system announcement ID in table AINANNS.

Table size

0 to 65 534 tuples

AINANNS (continued)

Datavill

The following table lists datavill for table AINANNS.

Field descriptions

Field	Subfield or refinement	Entry	Explanation and action
KEY		numeric (1 to 65535)	<p><i>Key</i></p> <p>Enter a numeric value representing the announcement message ID received from the service control point (SCP) in a response operation.</p> <p>Note: There is no restriction on datavill order, so datavill can be done in ranges such that the table is not contiguous.</p>
CLLI		alphanumeric (up to 16 characters)	<p><i>Common language location identifier</i></p> <p>Enter the common language location identifier (CLLI) of the announcement group, as datavilled in tables CLLI and ANNS.</p>
ANNNUM		numeric (1 to 255)	<p><i>Announcement member number</i></p> <p>Enter the announcement member number, as datavilled in table DRMUSERS.</p>

Datavill example

The following example shows sample datavill for table AINANNS.

MAP display example for table AINANNS

KEY	CLLI	ANNNUM
3	NWMS	6

Table history

NA017

DMS-100 SSP standard and customized announcements are mapped to the system announcement ID in table AINANNS with feature 59037140.

AINPRESC

Table name

AIN PRefix ESCape

Functional description

The table AINPRESC stores information about the AIN escape triggers (SPECARR, ONEPLUS, INTERNTL, or OPERSERV) with the specific prefix digits patterns. In the presence of the prefix digits patterns for a specific trigger, triggering will not occur. The AIN Toll Free Service trigger is not affected by the AIN 800 CDP trigger precedence feature.

Datafill sequence and implications

Table AINPRESC must be datafilled before table TRIGITM.

Table size

0 to 1024 tuples

Table AINPRESC table size is dynamically allocated.

Datafill

The following table lists datafill for table AINPRESC.

Field descriptions

Field	Subfield	Entry	Explanation and action
ESCKEY	None	0 to 8 alphanumeric characters	Escape Key name. Enter a name to uniquely identify the Escape Key.
OPTIONS	OPTION	Subfield OPTION can take one of the Values: SPECARR, ONEPLUS, INTERNTL, OPERSERV	An area with subfield OPTION. The remaining values are dependent on the values taken by OPTION. Subfield OPTION contains the name of the trigger on which escaping is done. OPTION is a selector for the four refinements: <ul style="list-style-type: none"> • specarr_serv_option • one_plus_option • interntl_option • oper_serv_option

AINPRESC (continued)**Field descriptions**

Field	Subfield	Entry	Explanation and action
	SPECARR	Vector of CAC, CACNXX, CAC0M, CAC00M, CAC0NXX, CAC0NPA, CAC1NXX, CAC1NPA, CAC011P, CAC01P	Prefix digits escape pattern: 101XXXX 101XXXX NXX 101XXXX 0 101XXXX 00 101XXXX 0 NXX 101XXXX 0 NPA 101XXXX 1 NXX 101XXXX 01 + 101XXXX 011 + 101XXXX 01 +
	ONE_PLUS	Vector of 1NXX, 1NPA, CAC1NXX, CAC1NPA	Prefix digits escape pattern: 1 NXX 1 NPA 101XXXX 1 NXX 101XXXX 1 NPA
	INTERNTL	Vector of 011P, 01P, CAC011P, CAC01PA	Prefix digits escape pattern: 011 + 01 + 101XXXX 011 + 101XXXX 011 +
	OPER_SERV	Vector of 0M, 00M, CAC0M, CAC00M, 0P, 01P, CAC0P, CAC01P	Prefix digits escape pattern: 0 00 101XXXX 0 101XXXX 00 0 + 01 + 101XXXX 0 + 101XXXX 01 +

Datafill example

The following examples show sample datafill for table AINPRESC.

AINPRESC (end)**MAP display example for table AINPRESC**

```

TABLE: AINPRESC
>add
ESCKEY:
>ZEROESC
OPTION:
>asdf
*** ERROR ***
ASDF
|
TYPE OF OPTION IS AINPRESC_OPTION
OPTION:
>asdf
*** ERROR ***
ASDF
|
TYPE OF OPTION IS AINPRESC_OPTION
TYPE IS AINPRESC_OPTION {OPERSERV,SPECARR, INETRNTL, ONEPLUS}
OPTION:
>OPERSERV
OPER_SERV_OPT:
>asdf
*** ERROR ***
ASDF
|
TYPE OF OPER_SERV_OPT IS OPER_SERV_OPTION
OPER_SERV_OPT:
>asdf
*** ERROR ***
ASDF
|
TYPE OF OPER_SERV_OPT IS OPER_SERV_OPTION
TYPE IS OPER_SERV_OPTION {0,00,CAC0,CAC00,0P,01P,CAC0P,CAC01P}
OPER_SERV_OPT:
>0
OPER_SERV_OPT:
>$
TUPLE TO BE ADDED:
ZEROESC OPERSERV (0) $
ENTER Y TO CONFIRM, N TO REJECT OR E TO EDIT.
>y
TUPLE ADDED
JOURNAL FILE INACTIVE

```

Table history**SN07 (DMS)**

This table was introduced in feature 59040089 (SN05), AIN Operator Services Trigger. First customer documentation in SN07 (DMS).

AINPRI

Table name

Advanced Intelligent Networks Primary Rate Interface

Functional description

Table ANIPRI supports subscription to an AIN PRIB trigger on a PRI B-channel.

Datafill sequence and implications

The following tables must be datafilled before table AINPRI.

- LTMAP
- TRKMEM
- TRIGITM

Table size

The system dynamically allocates table size from 0 to 64 000 tuples.

Datafill

The following table lists datafill for table AINPRI.

Field descriptions (Sheet 1 of 2)

Field	Subfield or refinement	Entry	Explanation and action
PRIMEMS			PRI Members This field is the key to table AINPRI and has four parts: LTGRP, LTNUM, FROMCHNL and TOCHNL
	LTGRP	ISDN, MFT, WITS, ACD, FUNC, BRI_OTTO, MFT_OTTO, BRI_TRA	Logical terminal group number Identifies the logical terminal group of a logical terminal.
	LTNUM	1 to 1022	Logical terminal number in a group Identifies the logical terminal number of a logical terminal.
	FROMCHNL	0 to 9999	From channel Identifies the beginning of a range of B-channels in a logical terminal.
	TOCHNL	0 to 9999	To channel Identifies the end of a range of B-channels in a logical terminal

AINPRI (continued)**Field descriptions (Sheet 2 of 2)**

Field	Subfield or refinement	Entry	Explanation and action
TIIDLIST			Trigger item identification list. This two-part field indicates the trigger item datafilled in table TRIGITM.
	TDP		Trigger detection point. Datafill the standard two-digit number representing a trigger detection point (TDP).
	NAME	8-character alphanumeric string	Name Datafill the trigger item name.
	TRIGACT	ON or OFF	Trigger active Datafill the field with option ON to activate the trigger item in the TIID. Datafill the field with option OFF to deactivate the trigger item in the TIID.

Datafill example

The following example shows sample datafill for table AINPRI.

MAP display example for table AINPRI

PRIME MS	TIIDLIST
ISDN 567 12 45	03 PRIB ON

Table history
NA010

Feature AU2858 (AINSSP: AIN Channel_Setup_PRI Trigger) introduces table AINPRI.

Supplementary information

This section explains the error messages that can occur if you incorrectly datafill table AINPRI.

AINPRI (continued)

Error messages

The following error message appears on the MAP display if operating company personnel attempt to datafill table AINPRI when a logical terminal is not datafilled in table LTMAP.

```
*** Logical terminal NOT yet defined in table LTMAP **
```

The following error message appears on the MAP display if operating company personnel attempt to datafill an entry in table AINPRI using a logical terminal that is not a PRA logical terminal class.

```
*** Logical Terminal must be a PRA logical terminal class  
in table LTDEF ***
```

When attempting to datafill an entry in table AINPRI using U449/U459 PRI logical terminal, the following message is displayed.

```
***PRI variants must be NTNAPRI or NIPRI  
Trigger type PRIB is not compatible with the PRI trunk **
```

The following error message appears on the MAP display if operating company personnel attempt to datafill an entry in table AINPRI using a logical terminal that has the B-channel Negotiation feature on the PRI trunk group.

```
*** PRI trunk group has B-channel Negotiation enabled in  
table TRKSGRP **
```

The following error message appears on the MAP display if a trunk external name specifies a trunk that is not in table TRKMEM.

```
*** Trunk external name NOT yet defined in table TRKMEM ***
```

If operating company personnel specify a range of B-channels in the wrong order in table AINPRI, the MAP displays the following message.

```
*** TOCHNL must be greater than or equal to FROMCHNL**
```

The following error message appears on the MAP display if the specified trigger item is not in table TRIGITM.

```
*** Trigger item is NOT defined in table TRIGITM **
```

The following error message appears on the MAP display if a datafilled trigger item is not of PRIB trigger type.

AINPRI (end)

***Trigger type XXX is not compatible with the PRI trunk **

Note: XXX represents the specific trigger that operatin company personnel datafill against the index key used in the TIIDLIST parameter in the new AINPRI tuple.

AIODGRP

Table name

Automatic Identified Outward Dialing Group Table

Overview

Automatic identified outward dialing (AIOD) provides a means of billing outgoing calls from a private branch exchange (PBX) to individual PBX stations. The call from a PBX can appear to the DMS on a PBX line or a PBX trunk.

AIOD information relating to a call on a particular PBX line or PBX trunk is provided over a separate datalink between the PBX and the host office. There may be one or more datalinks between the PBX and the host office.

The AIOD data transmitted to the host office is assembled by the DMS AIOD receiver equipment into a message, ready for presentation to DMS central control (CC) software.

CC software uses the PBX circuit identifier, or token, to determine which PBX trunk or line is carrying the associated telephone call, and assigns billing for that call to the station identified. The token given in the message uniquely identifies a PBX line or trunk.

In the case of a PBX trunk, the token is the external trunk name. For example, for trunk BNRCAR 1234, the external trunk name is AIOD PBX and the circuit identifier is 1234.

For a PBX line, the token is an arbitrary number and must be provided by datafill, typically using service orders (SO). The identifier is prompted for when the AIOD line option is assigned. For more information on the Service Order System (SERVORD), refer to the *SERVORD Reference Manual*.

The AIOD token must be unique for a specific PBX.

Table Auto-identified outward dialing tables llists AIOD tables.

Auto-identified outward dialing tables

Table name	Title of table
AIODGRP	AIOD Group Table
AIODMEM	AIOD Member Table
AIODTKN	AIOD Token Table

AIODGRP (continued)

A single AIOD card on a host DMS consists of four trunk receiver circuits, one on each datalink. The AIOD card is connected to DMS on a maintenance trunk module (MTM), occupying two circuit card slots and using four MTM ports, allowing four separate AIOD links to be serviced.

A PBX with AIOD facilities sends a call identification message (AIOD message) for every call it makes to the host central office. DMS needs the AIOD message for recordable, or billable, calls only. AIOD messages for non-billable calls are ignored.

Before routing a billable call from a PBX trunk or line, the DMS switch expects to have received an AIOD message from the PBX. Data contained in the AIOD message is used as part of the record, or records, for the identified telephone call.

If an AIOD message is not received by the time the DMS switch is ready to route, the DMS switch waits for a user-specified time (the value in field TIMEOUT in table AIODGRP) to cater for a late arrival of the message. If no AIOD message is received by the end of this time, the call can be, at the choice of the operating company, routed to treatment (auto-identified outward dialing failure (AIFL)) or allowed to proceed, but billed to the default PBX number, or PBX special billing number.

DMS-100 supports AIOD in both local automatic message accounting (LAMA) and non-LAMA environments. Both Northern Telecom and AT&T automatic message accounting (AMA) formats are compatible with AIOD. In a LAMA environment, the AMA record generated for an AIOD call contains a ten-digit station number, constructed from the default PBX billing number, or, if assigned, the special billing number, and the four-digit PBX station number, as identified by the AIOD equipment.

Table Default billing number shows an example of a default billing number in a LAMA environment.

Default billing number

Explanation	Number
Default billing number	6136211000
AIOD-identified station number	2123
Recorded number	6136212123
Note: The recorded number must be unique to the host office.	

AIODGRP (continued)

For 0+ and 0- calls, the calling number spilled to the position contains no special AIOD identifier (that is, an information digit or catcode).

In a non-LAMA office, the calling number spilled over a centralized AMA (CAMA) trunk, as for 0+ and 0- calls, contains no special information digit.

Functional description

Table AIODGRP contains the following information:

- common language location identifier (CLLI) of the AIOD group
- action taken if the AIOD message is not received
- length of time the call process waits if the AIOD message is late

Datafill sequence and implications

Table CLLI must be datafilled before table AIODGRP.

Table LENFEAT must be datafilled after table AIODGRP.

Table size

Memory is allocated (maximum 32 767 tuples) by the entry in field SIZE in table DATASIZE with AIODGRP entered in field DATSKEY.

To extend table AIODGRP, increase the value of field SIZE in table DATASIZE and do a cold restart.

To decrease the size of the table, delete all the tuples in table AIODGRP, change the value of field SIZE in table DATASIZE to 0 (zero) and do a cold restart. The table size can then be increased as stated above and the existing and new tuples added.

AIODGRP (end)**Datafill**

The following table lists datafill for table AIODGRP.

Field descriptions

Field	Subfield or refinement	Entry	Explanation and action
AIODGRP		alphanumeric (1 to 16 characters)	<i>Auto-identified outward dialing group</i> Enter the code that is assigned in table CLLI and represents the name of the auto-identified outward dialing (AIOD) group.
FAILDEF		RECORD or TREATMENT	<i>Auto-identified outward dialing failure default</i> This field defines the action taken if the AIOD message is not received. Enter RECORD if the call is allowed to proceed, but is billed to the default (private branch exchange (PBX) number or the PBX special billing number. Enter TREATMENT if a call is routed to the auto identified outward dialing failure (AIFL) treatment.
TIMEOUT		0 to 3	<i>Auto-identified outward dialing time out</i> Enter the length of time, in 1 s increments, that call processing is to wait if the AIOD message is late.

Datafill example

The following example shows sample datafill for table AIODGRP.

The example consists of AIOD group BNRCAR, which routes call to treatment AIFL if AIOD message is not received and waits 2 s if the AIOD message is late.

MAP display example for table AIODGRP

AIODGRP	FAILDEF	TIMEOUT
BNRCAR	TREATMENT	2

AIODMEM

Table name

Automatic Identified Outward Dialing Member Table

Functional description

Table AIODMEM contains the following information:

- common language location identifier (CLLI) and external trunk number of the member of the automatic identified outward dialing group (AIODGRP)
- AIOD data link number of the link to which the AIOD receiver is connected
- physical location of the AIOD receiver

For related information, refer to table AIODGRP.

Datafill sequence and implications

The following tables must be datafilled before table AIODMEM:

- CLLI
- TMINV
- AIODGRP

Table size

Memory is allocated (maximum 32 767 tuples) by field SIZE in table DATASIZE with field DATSKEY set to AIODMEM.

To extend table AIODMEM, increase the value of field SIZE in table DATASIZE, and do a cold restart.

To decrease the size of the table, delete all the tuples in the table, change the value of field SIZE in table DATASIZE to 0 (zero) and do a cold restart. The table size can then be increased as stated above and the existing and new tuples added.

AIODMEM (continued)**Datafill**

The following table lists datafill for table AIODMEM.

Field descriptions

Field	Subfield or refinement	Entry	Explanation and action
AIODMEM		see subfields	<i>Auto-identified outward dialing member</i> This field consists of subfields GROUP and MEMBER.
	GROUP	alphanumeric (1 to 16 characters)	<i>Auto-identifier outward dialing group</i> Enter the code, assigned in table AIODGRP, to which the member belongs.
	MEMBER	0 to 9999	<i>Auto-identifier outward dialing member number</i> Enter a member number. The member number must be unique for a specific auto-identified outward dialing (AIOD) group.
LINK		0 to 255	<i>Auto-identifier outward dialing link number</i> Enter the number of the physical transmission link to which the AIOD receiver is connected.
MTMNO		0 to 2047	<i>Maintenance trunk module number</i> Enter the number of the maintenance trunk module (MTM) on which the AIOD receiver is mounted.
MTMCKTNO		0 to 29	<i>Maintenance trunk module circuit number</i> Enter the circuit number of the AIOD receiver.

Datafill example

The following example shows sample datafill for table AIODMEM.

This example consists of AIOD group BNRCAR, which has members 0, 1, 2 and 3, uses link number 0, and the AIOD receiver is mounted on MTM 03, with circuits 4 through 7 (see field MTMCKTNO below).

AIDMEM (end)

MAP display example for table AIDMEM

AIDMEM				
GROUP	MEMBER	LINK	MTMNO	MTMCKTNO
BNRCAR	0	0	03	4

AIODTKN

Table name

Automatic Identified Outward Dialing Token Table

Functional description

Table AIODTKN is a read-only table and cannot be datafilled.

For trunk groups using the automatic identified outward dialing (AIOD) trunk option, a tuple is automatically added to, or deleted from, table AIODTKN for each TRKMEM tuple added or deleted. The external trunk name of the trunk member is used as the AIOD token for table AIODTKN.

For related information, refer to table AIODGRP.

Datafill sequence and implications

There is no requirement to datafill other tables prior to table AIODTKN.

Table size

Memory is dynamically allocated. A tuple is automatically added to, or deleted from, table AIODTKN as the AIOD line option is added to, or deleted, from lines in table LENFEAT.

Datafill

The following table lists datafill for table AIODTKN.

Field descriptions (Sheet 1 of 2)

Field	Subfield or refinement	Entry	Explanation and action
AIODTKN		see subfields	<i>AIOD token</i> This field consists of subfields GROUP and TOKEN.
	GROUP	alphanumeric (1 to 16 characters)	<i>AIOD group</i> This field contains the code that is datafilled in field AIODGRP in table AIODGRP.

AIODTKN (end)

Field descriptions (Sheet 2 of 2)

Field	Subfield or refinement	Entry	Explanation and action
	TOKEN	0 to 9999	<i>Token</i> If the auto identified outward dialing (AIOD) member is a PBX trunk, this field contains the external trunk number of the trunk. If the member is a private branch exchange (PBX) line, this field contains an arbitrary number that is the same value as the entry in field TOKEN in table LENFEAT.
TUPLE		see subfields	<i>Tuple</i> This field indicates the tuple that caused this tuple to be added to table AIODTKN. This field consists of subfields DATABLE and KEY.
	DATABLE	LENFEAT, TRKGRP, or TRKMEM, or NIL	<i>Data table</i> This field indicates the table in which this tuple was added. For an entry of NIL or TRKGRP there are no additional subfields. For an entry of TRKMEM or LENFEAT, subfield KEY is also present.
	KEY	alphanumeric (up to 4 characters)	<i>Data table key</i> If the entry in field DATABLE is LENFEAT, this field specifies the line equipment number in table LENFEAT. If the entry in field DATABLE is TRKMEM, this field specifies the common language location identifier (CLLI) and the memory name (MEMNAME) from table TRKMEM that is used to add this tuple to table AIODTKN.

Datafill example

Table AIODTKN is a read-only table and cannot be datafilled.

AISCAT

Table name

Automatic Intercept Service Category Table

Functional description

Table AISCAT is created to map the automatic number identification (ANI) identification (ID) digit received to one of the intercept call types. This table also specifies the expected number of digits to be found in the ANI spill.

Datafill sequence and implications

There is no requirement to datafill other tables prior to table AISCAT.

Table size

This is a fixed table with approximately five words for each tuple.

AISCAT (continued)**Datafill**

The following table lists datafill for table AISCAT.

Field descriptions

Field	Subfield or refinement	Entry	Explanation and action
ID		0 to 9	Identification digit. Enter the identification (ID) digit found in the multifrequency (MF) automatic number identification (ANI) spill.
FORMAT		ANI, ANIANIF, ANIF, or ONI	<p>Format field identity. This field identifies the number of digits expected in the MF ANI spill.</p> <p>Enter ANI if an ANI ID digit, a seven-digit called number, and signaling terminal (ST) pulse are expected.</p> <p>Enter ANIANIF if at least an ANI ID and ST pulse are expected. If called digits are not received, an ANI failure has been identified by the originating office. If seven digits are received, the call is marked as ANI success.</p> <p>Enter ANIF if an ANI failure is detected at the originating office, and an ANI ID digit and a ST pulse are expected. Operator identification of the called number is also expected.</p> <p>Enter ONI (operator number identification) if an ANI ID and ST pulse are expected. Operator identification of the called number is also expected.</p>
CLGSERV		BLDNINTC INTC or TRBLINTC	<p>Calling service. Enter the intercept call type. The calling service class is set to station and the call origination type is set to intercept.</p> <p>Enter BLDNINTC if the intercept call type is set to blank number call type.</p> <p>Enter INTC if the intercept call type is set to regular.</p> <p>Enter TRBLINTC if the intercept call type is set to trouble or special intercept.</p>

Datafill example

The following example shows sample datafill for table AISCAT.

MAP display example for table AISCAT

ID	FORMAT	CLGSERV
0	ANI	BLDNINTC
1	ANI	TRBLINTC
3	ANI	INTC

AKEYTAB

Table name

Access Key table

Functional description

Table AKEYTAB preserves the relationship between integrated link maintenance (ILM) access_keys and device mtce_ids over batch change supplement (BCS) applications.

The system restricts direct access to the table. Subscribers have read-only access. To gain indirect access, the subscriber can enter a device that requires resources that ILM supports. Indirect access can occur as part of a restore operation on the N + 1 BCS, as part of a BCS application.

Datafill sequence and meaning

This section does not apply. The table is write-protected against direct datafill.

Table size

0 to 1024 tuples. The number of tuples dynamically determines the table size.

AKEYTAB (continued)**Datafill**

The datafill for table AKEYTAB appears in the following table.

Field descriptions (Sheet 1 of 2)

Field	Subfield or refinement	Entry	Explanation and action
AKEY		0 to 1023	<p><i>Access key.</i> This tuple is the identifier that ILM uses to identify a group of accesses. The processing entity maintenance (PEM) considers these accesses as related.</p> <p>An access is a location where processing entities can access transport facilities. Transport facilities include a port or link interface, or a bus tap. The ILM uses access_ids as a form of identifier for these access points because ILM interacts with different maintenance subsystems. The ILM does not have to know all the names that connecting maintenance systems have for transport facility interfaces.</p> <p>The PEM determines when the system reassigns each access in the set an access_index. The selection of index does not affect the ILM. The ILM uses this index to identify the access when the ILM communicates with other maintenance subsystems.</p> <p>The system allocates this access key when you enter a PEM device.</p>
MTCEID		see subfields	<p><i>Maintenance identifier.</i> This tuple is an identifier for a resource. This tuple is constant over BCS applications. This tuple is a multiple with two fields: DISC and NUM.</p>

AKEYTAB (continued)

Field descriptions (Sheet 2 of 2)

Field	Subfield or refinement	Entry	Explanation and action
	DISC	0 to 255	<p><i>Maintenance discriminator.</i> The maintenance discriminator performs the following operations:</p> <ul style="list-style-type: none"> identifies the different areas of maintenance responsibility routes requests from general maintenance software to software for an application, like a peripheral <p>In an MTCEID, the DISC field refers to the maintenance subsystem that contains the resource.</p>
	NUM	0 to 511	<p><i>MTCEID resource number.</i> This MTCEID resource number contains identifiers that specify one of the resources that a maintenance subsystem contains.</p>

Datavfill example

Sample datavfill for table AKEYTAB appears in the following example.

MAP example for table AKEYTAB

AKEY	MTCEID
0	3 0
1	3 1
2	4 0
3	4 1
4	4 2

Table history

BCS26

Table AKEYTAB was introduced in BCS26.

AKEYTAB (end)

Additional information

Restore table AKEYTAB before you restore the inventory tables of the devices that require ILM resources. These tables are APINV, LIMINV, LIUINV, and NIUINV.

ALARMTAB

Table name

Threshold Alarms Table

Overview

The operational measurements (OM) threshold alarm tables, ALARMTAB and OMTHRESH, have identical functions, except ALARMTAB is a read-only table and OMTHRESH is a read-write table. Only thresholding of OMs is allowed. Thresholding of log reports is no longer supported. Threshold count in table ALARMTAB is done at intervals of 1 min. In table OMTHRESH the time period is specified by the operating company. If the threshold limit is exceeded, an alarm of the specified severity is generated. Log report OM2200 is also generated for downstream processing.

Once an alarm is generated for a specific entry in the table, alarm generation for the entry is suppressed for 15 min.

Functional description

Table ALARMTAB is write-protected and datafilled in advance by the system. Any additions or changes (no deletions) to this table can be made through Northern Telecom's technical support personnel.

Each record in table ALARMTAB refers to a specific OM register. In addition, a threshold value, scan time, and an alarm level (critical, major, minor, or no alarm) is specified. The threshold represents the amount an OM register must be incremented during the scan period (normally 1 min) to activate the associated alarm.

When an alarm is activated for an OM, log report OM2200 is also generated.

Datafill sequence and implications

Table TMINV must be datafilled before table ALARMTAB.

Table size

0 to 128 tuples

ALARMTAB (continued)**Datafill**

The following table lists datafill for table ALARMTAB.

Field descriptions

Field	Subfield or refinement	Entry	Explanation and action
KEY		alphanumeric (1 to 16 characters)	<p><i>Key</i> Enter data in one of the following formats:</p> <ul style="list-style-type: none"> • <name of OM register>\$<name of tuple> • <name of OM register>\$<number of tuple> • <name of OM register>\$<total>
ENABLED		Y or N	<p><i>Enabled</i> Enter Y (yes) if thresholding of OM is done; otherwise, enter N (no).</p>
ALMLEVEL		CR, MJ, MN, NA	<p><i>Alarm level</i> Enter the type of alarm activated: CR (critical), MJ (major), MN (minor), or NA (no alarm).</p>
THRESHLD		1 to 32767	<p><i>Threshold</i> Enter the number of events that, when exceeded during the specified time interval (scan time), activates an alarm. Indicated values outside this range are invalid. The default value for this field is 1.</p>
SCANTIME		1 to 32767	<p><i>Scan time</i> Enter the time interval, in minutes, to specify when thresholding is done. Indicated values outside this range are invalid. The default value for this field is 1.</p>

Datafill example

The following example shows sample datafill for table ALARMTAB.

ALARMTAB (end)

MAP display example for table ALARMTAB

KEY	ENABLED	ALMLEVEL	THRESHLD	SCANTIME
EXTOVFL,\$49	Y	MJ 1	1	
CCBOVFL,\$0	Y	MJ 1	1	
CPLOOVFL,\$0	Y	MN 1	1	
CPLPOVFL,\$0	Y	CR 1	1	
OUTBOVFL,\$0	Y	MJ 1	1	

ALMSC

Table name

Alarm Scan

Functional description

Table ALMSC identifies the function performed by each of the assigned scan (SC) points in the alarm scan groups.

The table that points into table ALMSC is Alarm Scan Group (ALMSCGRP). See the description of table ALMSCGRP for more information.

The following table lists available scan point functions.

Scan point functions

Scan point	Function
ABMTMFL	Alarm battery failure, miscellaneous trunk module
ABOAUFL	Alarm battery failure, office alarm unit
ABSFAIL	Alarm battery supply failure
ACDLPTST	Alarm control and display lamp test
ALMGRP	Alarm grouping
AUDARM	Audible alarm reset, miscellaneous trunk module
AUDARD	Audible alarm reset, office alarm unit
AUDDIS	Audible alarm disable
CRPREFLR	Critical alarm, preceding floor
CRPWR	Critical power alarm
CRSUCFLR	Critical alarm, succeeding floor
FEEDLOSS1	DMS power feed loss, OAU
FEEDLOSS2	DMS power feed loss, MTM
FSPAIS	Frame supervisory panel aisle XX = A to Z and AA to RR (excluding I, O, II, and OO)
<p>Note: When you assign a scan point for detection of low voltage (LOWBATT1 and LOWBATT2 on the NT3X82 card), you must also assign the LOWVOLTPOWER SD function.</p>	

ALMSC (continued)**Scan point functions**

Scan point	Function
LOWBATT1	Low office battery, OAU (See Note)
LOWBATT2	Low office battery, MTM (See Note)
MJPREFLR	Major alarm, preceding floor
MJPWR	Major power alarm
MJSUCFLR	Major alarm, succeeding floor
MNPREFLR0	Major alarm, preceding floor
MNPWR	Minor power alarm
MNSUCFLR	Minor alarm, succeeding floor
PDCFAIL	Power distribution center failure
RDBALM	Remote distribution bay alarm
RDTALRMCO	Remote digital terminal alarm cut-off
REMOTEAR	Remote alarm release
TONEMONITOR	Tone monitor for alarm sending
TSTLN101	101 test line
TTCNTXFR	TTC night alarm transfer
VCEALMO	Recorded announcement 0 (zero)
XFRALM	Alarm transfer
130MONITOR	130-V monitor (See Note)

Note: When you assign a scan point for detection of low voltage (LOWBATT1 and LOWBATT2 on the NT3X82 card), you must also assign the LOWVOLTPWR SD function.

Scan and signal distribution points work together. SC points detect alarm conditions such as loss of loop closure, ground, or battery feed. SD points report these alarm conditions audibly (bells) or visually (lights).

For each alarm SC point with field LOGIC set to Y (yes), the alarm SD functions are part of the system logic (fixed).

ALMSC (continued)

For each alarm SC point with field LOGIC set to N (no), the operating company can define up to 14 related SD functions.

If Field LOGIC is set to Y to designate a fixed function, the affected SD point generates an audible or visual alarm.

If field LOGIC is set to N to designate a non-fixed function, the operating company must set up the related SD point for the desired type of alarm indication.

Nortel provides a standard set of SD functions for each alarm SC point that has field LOGIC set to Y.

The standard set of SD functions for each alarm SC point can be changed by the operating company to suit their requirements.

The following table lists the available signal distribution point functions.

Signal distribution point functions

Signal distribution point	Function
ABAUD	Alarm battery supply, audible alarm
AB0AU	Alarm battery supply, OAU, visual
ABSVIS	Alarm battery supply, visual
ALMXFR	Alarm transfer
COMAUD1	Common audible, OAU
COMAUD2	Common audible, MTM
CRALMAUD	Critical alarm audible
CRALMVIS	Critical alarm visual
CRPWRVIS	Critical power alarm visual
EXPILDMS	Exit pilot DMS
EXPILPWR	Exit pilot power
Note: When you assign a scan point for detection of low voltage (LOWBATT1 and LOWBATT2 on the NT3X82 card), you must also assign the LOWVOLTPWR SD function. You use scan point 130MONITOR only for non-LPA systems (systems that do not contain the NT3X83BA card). For LPA configurations, use MONITOR.	

ALMSC (continued)**Signal distribution point functions**

Signal distribution point	Function
LN101TST	101 test line
LOWVOLTPWR	Low DMS office battery level
MJALMAUD1 & 2	Major alarm audible (1 OAU, 2 MTM)
MJALMVIS	Major alarm visual
MJOTHVIS	Major alarm, other floor, visual
MJPWRVIS	Major power alarm visual
MJVISLOOP	Major alarm visual loop
MJXFR	Major alarm transfer
MNALMAUD	Minor alarm audible
MNALMVIS	Minor alarm visual
MNOTHVIS	Minor alarm, other floor, visual
MNPWRVIS	Minor power alarm visual
MNVISLOOP	Minor alarm visual loop
MNXFR	Minor alarm transfer
MTMFAIL	Miscellaneous trunk module failure
MTMPWR	Miscellaneous trunk module power transfer
NTALMXFR	Night alarm transfer
OAUFAIL	Office alarm unit failure
OAUFLAUD	Office alarm unit failure, audible
OAUFLVIS	Office alarm unit failure, visual
OAPWR	Office alarm unit power transfer

Note: When you assign a scan point for detection of low voltage (LOWBATT1 and LOWBATT2 on the NT3X82 card), you must also assign the LOWVOLTPWR SD function. You use scan point 130MONITOR only for non-LPA systems (systems that do not contain the NT3X83BA card). For LPA configurations, use MONITOR.

ALMSC (continued)**Signal distribution point functions**

Signal distribution point	Function
OAUVISLOOP	Office alarm unit power visual loop
PDCVIS	Power distribution center visual
PREFLRCR	Preceding floor, critical alarm
PREFLRMJ	Preceding floor, major alarm
PREFLRMN	Preceding floor, minor alarm
SUCFLRCR	Succeeding floor, critical alarm
SUCFLRMJ	Succeeding floor, major alarm
SUCFLRMN	Succeeding floor, minor alarm

Note: When you assign a scan point for detection of low voltage (LOWBATT1 and LOWBATT2 on the NT3X82 card), you must also assign the LOWVOLTPOWER SD function. You use scan point 130MONITOR only for non-LPA systems (systems that do not contain the NT3X83BA card). For LPA configurations, use MONITOR.

The following table lists suggested miscellaneous alarm scan point functions for use by the operating company. The operating company supplies input data for the miscellaneous alarm SC points.

Suggested miscellaneous alarm scan point functions

Scan point	Function	Type
FIREALM	Fire alarm	CR
SMOKEALM	Smoke alarm	CR
GASALM	Building gas alarm	CR
FRONTDOR	Front door alarm	MJ
REARDOR	Rear door alarm	MJ
HIGHTEMP	Building high temperature alarm	MJ
LOWTEMP	Building low temperature alarm	MJ
HIGHHUM	Building high humidity alarm	MJ
LOWHUM	Building low humidity alarm	MJ

ALMSC (continued)**Suggested miscellaneous alarm scan point functions**

Scan point	Function	Type
COMACFAL	Commercial AC failure alarm	MJ
AIRDRYER	Air dryer failure alarm	MJ
CABPRESS	Cable pressure low alarm	MJ
SEWPUMP	Sewage pump alarm	MJ
HIWATER	Sump pump high water alarm	MJ
RDBALM	Remote distributor bays	CR
VCEALM1-4	Recorded announcements	MN

Datafill sequence and implications

You must datafill the hardware alarm scan groups in table ALMSCGRP before you datafill table ALMSC. After you enter the scan groups in table ALMSCGRP, you can datafill table ALMSC with the scan group numbers in the ALMSCGRP tuple entries.

To use the signal distribution point functions in table ALMSC, they must first be datafilled in table ALMSD.

To activate the FSP Alarm reporting feature for remote MG4Ks, datafill the FSP_REMOTE_SMG4 scan function in table ALMSC. Without this datafill, the feature is not available.

For common language location identifier (CLLI) OAUSC in table CLLI, you must datafill field TRKGRSIZ as the number of tuples in table ALMSCGRP.

Note: The trunk group size for fixed pseudo CLLI codes OAUSC and OAUSD is equal to the number of scan and signal distribution groups required for office alarm.

Table size

The maximum size is 4096 tuples. Memory is automatically allocated for 4096 SC points. If you do not datafill all the predefined SC points, the size of table ALMSC decreases

Datafill

The following table lists datafill for table ALMSC. You datafill fields FUNCTION, SCGROUP, POINT, NORMALST, REPORT, ALM, and

ALMSC (continued)

subfield LOGIC only if the entry is the first record for the scan point. If the entry is not the first record for the scan point, you leave these fields blank.

Field descriptions

Field	Subfield or refinement	Entry	Explanation and action
FUNCTION		alphanumeric (vector of up to 16 characters)	<i>Function</i> Enter the alarm scan point. See the first table for a list of alarm scan point functions. See the third table for a list of suggested miscellaneous alarm scan point functions.
SCGROUP		0 to 512	<i>Scan group</i> Enter the scan group to which the scan point belongs. Note: For the FSP_REMOTE_SMG4 scan function, SCGROUP should be datafilled for FSP Alarm reporting of remote MG4Ks only. It should not be used by any other co-located peripherals in the office for alarm reporting.
POINT		0 to 6	<i>Scan point</i> Enter the scan point number within the scan group.
NORMALST		0 to 1	<i>Normal state</i> Enter the normal state of the scan point. If the scan point is normally off or open, enter 0 (zero). If the scan point is normally on or closed, enter 1. Note: For the FSP_REMOTE_SMG4 scan function, NORMALST should have the value 0.
REPORT		Y or N	<i>Report</i> Enter Y (yes) if an alarm report is logged; otherwise, enter N (no). Note: The REPORT field value determines whether the FSP Alarm reporting feature for remote MG4Ks is logged or not. If REPORT is Y, then FSP Faults (SIM A/ SIM B/ PCIU/ FAN) in remote MG4Ks cause logs SPM619 and EXT102 to be generated. If REPORT is N, no logs are generated.

ALMSC (continued)**Field descriptions**

Field	Subfield or refinement	Entry	Explanation and action
ALM		CR, MJ, MN, or NA	<i>Alarm</i> Enter the type of alarm to be activated: CR (critical alarm), MJ (major alarm), MN (minor alarm), or NA (no alarm).
LOGIC		see subfields	<i>Logic</i> This field consists of subfield FIX_LOGIC.
	FIX_LOGIC	Y or N	<i>Fix logic</i> Enter Y if the logic associated with the function is fixed. If you enter Y, no other datafill is required. Enter N if the logic associated with the function is not fixed. Then, datafill refinements SDFUNCT, ALMGRP, and ALMXFR.
NON_FIX_LOGIC_VECTOR		see subfields	This field consists of subfields SDFUNCT, ALMGRP, and ALMXFR.
	SDFUNCT	alphanumeric	<i>Signal distribution function</i> Enter the signal distribution (SD) function or functions associated with a specific scan point. See the second table for a list of SD point functions.
	ALMGRP	Y or N	<i>Alarm grouping</i> Enter Y if the alarm function is activated when the alarm grouping key is activated. Enter N if the alarm function is activated at all times, regardless of the alarm grouping key setting.
	ALMXFR	Y or N	<i>Alarm transfer</i> Enter Y if the alarm function is activated when the alarm transfer key is activated, otherwise, enter N.

Datafill example

The following example shows sample datafill for table ALMSC.

ALMSC (continued)

MAP display example for table ALMSC

FUNCTION	SCGROUP	POINT	NORMALST	REPORT	ALM	LOGIC
REMOPEAR	2	1	0	Y	NA	Y
XFRALM	2	0	0	Y	NA	Y
TTCNTXFR	2	3	0	Y	NA	Y
AUDARO	0	1	0	Y	NA	Y
CRPWR	4	0	0	Y	CR	N (CRPWRVIS N N) (CRALMAUD N N) (COMAUD1 N N) (COMAUD2 N N) (CRVISLOOP N N) (PREFLRCR N N) (EXPILPWR N N) (MJXFR N N) (SUCFLRCR Y N) \$
MJPWR	4	1	0	Y	MJ	N (MJPWRVIS N N) (MJALMAUD1 N N) (MJALMAUD2 N N) (COMAUD1 N N) (COMAUD2 N N) (MJVISLOOP N N) (PREFLRMJ N N) (EXPILPWR N N) (MJXFR N Y) (SUCFLRMJ Y N) \$
MNPWR	4	2	0	Y	MN	N (MNPWRVIS N N) (MNALMAUD N N) (COMAUD1 N N) (COMAUD2 N N) (MNVISLOOP N N) (PREFLRMN N N) (EXPILPWR N N) (MJXFR N Y) (SUCFLRMN Y N) \$

ALMSC (continued)**MAP display example for table ALMSC (continued)**

FUNCTION	SCGROUP	POINT	NORMALST	REPORT	ALM	LOGIC
ACDLPTST	4	5	0	Y	NA	Y
TSTLN101	2	4	0	Y	MN	Y
PDCFAIL	4	3	0	Y	MJ	N (PDCVIS N N) (MJALMAUD1 N N) (MJALMAUD2 N N) (COMAUD1 N N) (COMAUD2 N N) (EXPILDMS N N) (PREFLRMJ N N) (MJVISLOOP N N) (MJXFR N Y) (SUCFLRMJ Y N) \$
ABSFAIL	4	4	0	Y	MN	N (ABAUD N N) (ABPDC N N) (COMAUD1 N N) (COMAUD2 N N) (EXPILDMS N N) (PREFLRMN N N) (OAUVISLOOP N N) (MNXFR N Y) (SUCFLRMN Y N) \$
FSPAISA	5	0	0	Y	MJ	N (MJALMVIS N N) (MJALMAUD1 N N) (MJALMAUD2 N N) (COMAUD1 N N) (COMAUD2 N N) (MJVISLOOP N N) (PREFLRMJ N N) (EXPILDMS N N) (MJXFR N Y) (SUCFLRMJ Y N) \$

ALMSC (continued)**MAP display example for table ALMSC (continued)**

FUNCTION	SCGROUP	POINT	NORMALST	REPORT	ALM	LOGIC
FSPAISB	5	1	0	Y	MJ	N (MJALMVIS N N) (MJALMAUD1 N N) (MJALMAUD2 N N) (COMAUD1 N N) (COMAUD2 N N) (MJVISLOOP N N) (PREFLRMJ N N) (EXPILDMS N N) (MJXFR N Y) (SUCFLRMJ Y N) \$
FSFSPAISC	5	2	0	Y	MJ	N (MJALMVIS N N) (MJALMAUD1 N N) (MJALMAUD2 N N) (COMAUD1 N N) (COMAUD2 N N) (MJVISLOOP N N) (PREFLRMJ N N) (EXPILDMS N N) (MJXFR N Y) (SUCFLRMJ Y N) \$
FSPAISD	5	3	0	Y	MJ	N (MJALMVIS N N) (MJALMAUD1 N N) (MJALMAUD2 N N) (COMAUD1 N N) (COMAUD2 N N) (MJVISLOOP N N) (PREFLRMJ N N) (EXPILDMS N N) (MJXFR N Y) (SUCFLRMJ Y N) \$

ALMSC (continued)**MAP display example for table ALMSC (continued)**

FUNCTION	SCGROUP	POINT	NORMALST	REPORT	ALM	LOGIC
FSPAISE	5	4	0	Y	MJ	N (MJALMVIS N N) (MJALMAUD1 N N) (MJALMAUD2 N N) (COMAUD1 N N) (COMAUD2 N N) (MJVISLOOP N N) (PREFLRMJ N N) (EXPILDMS N N) (MJXFR N Y) (SUCFLRMJ Y N) \$
FSPAISF	5	5	0	Y	MJ	N (MJALMVIS N N) (MJALMAUD1 N N) (MJALMAUD2 N N) (COMAUD1 N N) (COMAUD2 N N) (MJVISLOOP N N) (PREFLRMJ N N) (EXPILDMS N N) (MJXFR N Y) (SUCFLRMJ Y N) \$
AUDDIS	5	6	0	Y	MN	N (MNALMVIS N N) \$
OMONITOR	2	2	0	Y	MJ	N (MJALMVIS N N) \$
LOWBATT1	0	2	0	Y	MJ	N (LOWVOLTPWR N N) (MJPWRVIS N N) (MJALMAUD1 N N) (MJALMAUD2 N N) (COMAUD1 N N) (COMAUD2 N N) (MJVISLOOP N N) (PREFLRMJ N N) (EXPILPWR N N) (MJXFR N N) (SUCFLRMJ N N) \$

ALMSC (continued)**MAP display example for table ALMSC (continued)**

FUNCTION	SCGROUP	POINT	NORMALST	REPORT	ALM	LOGIC
LOWBATT2	1	2	0	Y	MJ	N (LOWVOLTPWR N N) (MJPWRVIS N N) (MJALMAUD1 N N) (MJALMAUD2 N N) (COMAUD1 N N) (COMAUD2 N N) (MJVISLOOP N N) (PREFLRMJ N N) (EXPILPWR N N) (MJXFR N N) (SUCFLRCR N N) \$
FEEDLOSS1	0	4	0	Y	CR	N (CRPWRVIS N N) (CRALMAUD N N) (COMAUD1 N N) (COMAUD2 N N) (CRVISLOOP N N) (PREFLRCR N N) (EXPILPWR N N) (MJXFR N N) (SUCFLRCR N N)
FEEDLOSS2	1	4	0	Y	CR	N (CRPWRVIS N N) (CRALMAUD N N) (COMAUD1 N N) (COMAUD2 N N) (CRVISLOOP N N) (PREFLRCR N N) (EXPILPWR N N) (MJXFR N N) (SUCFLRCR N N) \$
FSP_REMOTE_SMG4		0	1	0	Y MJ N	(MJALMVIS N N) \$

The following examples show possible datafill for FSP Alarms for frame failures for remotely located MG4K nodes. The first shows the datafill to generate audible and visual alarms at the host; the second shows the datafill to turn off audible and visual alarms at the host.

ALMSC (end)

MAP display example for table ALMSC, with alarms at the host

```
FUNCTION SDGROUP POINT NORMALST REPORT ALM LOGIC
-----
FSP_REMOTE_SMG4 0 1 0 Y MJ N (MJMALVIS N N) (MJALMAUD1 N N) $
```

MAP display example for table ALMSC, with no alarms at the host

```
FUNCTION SDGROUP POINT NORMALST REPORT ALM LOGIC
-----
FSP_REMOTE_SMG4 0 1 0 Y MJ N $
```

Table history

SN06 (DMS)

Added datafills to implement FSP Alarms for frame failures for remotely located MG4K nodes for activity 89007540.

BASE11

Changes associated with the Low Power Alarm (LPA) system

BCS36

The following changes were made to table ALMSC:

- changed LOWVOLT PWR to LOWVOLTPWR
- added new tuples to datafill example

ALMSCGRP

Table name

Alarm Scan Group

Overview

The following office alarm systems (OAS) exist:

- Version 1
- Version 2
- Version 2 Enhanced Alarm System (EAS)
- Low Power Alarm (LPA) system

The DMS alarm systems detect and report failures and service degradations. The alarm system is a set of hardware devices and software modules that provide the following:

- visual (lights) and audible (tones) indication of alarm conditions
- transfer of critical, major, and minor alarms to remote sites
- data loops for a portable MAP terminal
- battery power feed for telephone headset communication within the office with the following:
 - frame supervisory panel (FSP)
 - maintenance supervisory panel (MSP)
 - main distribution frame (MDF)
 - operator MAP terminal access points

The alarm system uses scan (SC) points and signal distribution (SD) points to monitor and report the alarm status of each equipment row, to a maximum of 40 rows. Scan points detect voltage, ground, open-loop, or closed-loop conditions. Signal distribution points transfer alarm indications to alarm panels and other equipment. Hardware switch settings and datafill in tables ALMSCGRP, ALMSC, ALMSDGRP, and ALMSD define the scan and signal distribution points.

Some hardware is specific to one alarm system version. Other hardware, like scan and signal distribution cards, is common to all versions.

The office alarm unit (OAU) in Version 1 OAS is on a maintenance trunk module (MTM) shelf. All alarm detection and control hardware is in the OAU and an associated (standby) MTM. The Version 1 OAU uses NT2X41, NT2X42, and NT2X43 cards.

ALMSCGRP (continued)

The OAU is dedicated to the alarm system. The standby MTM contains the alarm system backup circuits that generate an alarm if the OAU fails. The standby MTM can also contain equipment not related to the alarm system.

In the Version 2 OAS and the EAS, the primary OAU and the standby unit are on an MTM or ISM shelf.

In the LPA system, the primary OAU and the standby unit are on an ISM shelf.

In Version 2 and later OAS, you can provision the alarm SC and SD hardware on various MTM or ISM shelves throughout the office.

For further information on the OAS, refer to *Alarm System Description*, 297-1001-122.

NT3X82 - OAU dead system card

The OAU dead system (NT3X82) cards used in Version 2, EAS, and LPA OAU contain both SC and SD points. These cards contain two circuits. The even-numbered circuit contains SD points and the odd-numbered circuit contains SC points. The following table shows the versions of NT3X82 card.

NT3X82 versions

PEC	Card name	Shelf	OAS
NT3X82AA	OAU dead system with unique audibles	MTM	Version 2
NT3X82AB	OAU dead system with common audibles	MTM	Version 2
NT3X82AC	OAU dead system with unique audibles	MTM	EAS
NT3X82AD	OAU dead system with common audibles	MTM	EAS
NT3X82AE	OAU dead system with unique audibles (-60V version)	MTM	EAS
NT3X82AF	OAU dead system with unique audibles	ISM	Version 2
NT3X82AG	OAU dead system with common audibles	ISM	Version 2
NT3X82AH	OAU dead system with unique audibles	ISM	EAS
NT3X82AJ	OAU dead system with common audibles	ISM	EAS
NT3X82AK	OAU dead system with unique audibles (-60V version)	ISM	EAS
NT3X82BA	LPA dead system audibles & IATC	ISM	LPA

ALMSCGRP (continued)

In the LPA system, the OAU common audibles, unique audibles, and the inactive timing circuit (IATC) clock are combined on the NT3X82BA card.

The following table lists the SD and SC points for NT3X82AA, NT3X82AC, NT3X82AE, NT3X82AF, NT3X82AH, or NT3X82BA cards in an OAU.

SD and SC points for NT3X82AA, NT3X82AC, NT3X82AE, NT3X82AF, NT3X82AH, or NT3X82BA in OAU

SD point	Function	Normal state	SC point	Function	Normal state
0	OAUFAIL	0	0	ABMTMFL	0
1	OAUPWR	0	1	AUDARO	0
2	MJALMAUD1	0	2	LOWBATT1	0
3	ABAUD	0	3	Internal circuit	0
4	ABOAU	0	4	FEEDLOSS1	0
5	COMAUD	0	5	Internal circuit	0
6	Internal circuit	0	6	Internal circuit	0
7	Internal circuit	0	7	Internal circuit	0

The following table lists the SD and SC points for the NT3X82AA, NT3X82AC, NT3X82AE, NT3X82AF, NT3X82AH, or NT3X82BA cards in a standby MTM or ISM.

SD and SC points for NT3X82AA, NT3X82AC, NT3X82AE, NT3X82AF, NT3X82AH, or NT3X82BA in standby MTM or ISM

SD point	Function	Normal state	SC point	Function	Normal state
0	MTMFAIL	0	0	ABOAUFL	0
1	MTMPWR	0	1	AUDARM	0
2	MJALMAUD2	0	2	LOWBATT2	0
3	OAUFLAUD	0	3	Internal circuit	0
4	OAUFLVIS	0	4	FEEDLOSS2	0
5	COMAUD	0	5	Internal circuit	0

4 Data schema tables

ALMSCGRP (continued)

SD and SC points for NT3X82AA, NT3X82AC, NT3X82AE, NT3X82AF, NT3X82AH, or NT3X82BA in standby MTM or ISM

SD point	Function	Normal state	SC point	Function	Normal state
6	Internal circuit	0	6	Internal circuit	0
7	Internal circuit	0	7	Internal circuit	0

The following table lists the SD and SC points for NT3X82AB, NT3X82AD, NT3X82AG, or NT3X82AJ cards in an OAU.

SD and SC points for NT3X82AB, NT3X82AD, NT3X82AG, or NT3X82AJ in OAU

SD point	Function	Normal state	SC point	Function	Normal state
0	OAUFAIL	0	0	ABMTMFL	0
1	OAPWR	0	1	AUDARO	0
2	Internal circuit	0	2	LOWBATT1	0
3	Internal circuit	0	3	Internal circuit	0
4	OAUFLVIS	0	4	FEEDLOSS1	0
5	COMAUD1	0	5	Internal circuit	0
6	Internal circuit	0	6	Internal circuit	0

The following table lists the SD and SC points for NT3X82AB, NT3X82AD, NT3X82AG, or NT3X82AJ cards in a standby MTM or ISM.

SD and SC points for NT3X82AB, NT3X82AD, NT3X82AG, or NT3X82AJ in standby MTM or ISM

SD point	Function	Normal state	SC point	Function	Normal state
0	MTMFAIL	0	0	ABOAUFL	0
1	MTMPWR	0	1	AUDARM	0
2	Internal circuit	0	2	LOWBATT2	0
3	Internal circuit	0	3	Internal circuit	0
4	OAUFLVIS	0	4	FEEDLOSS2	0

ALMSCGRP (continued)**SD and SC points for NT3X82AB, NT3X82AD, NT3X82AG, or NT3X82AJ in standby MTM or ISM**

SD point	Function	Normal state	SC point	Function	Normal state
5	COMAUD2	0	5	Internal circuit	0
6	Internal circuit	0	6	Internal circuit	0

NT3X83 - OAU alarm transfer card

The OAU alarm transfer (NT3X83) cards in Version 2, EAS, and LPA OAU contain SC and SD points. These cards contain two circuits. The even-numbered circuit contains SD points and the odd-numbered circuit contains SC points. The following table shows the versions of NT3X83 card.

NT3X83 versions

PEC	Card name	Shelf	OAS
NT3X83AA	OAU alarm transfer	MTM	Version 2, EAS
NT3X83AB	OAU alarm transfer (-60V version)	MTM	Version 2, EAS
NT3X83AC	OAU alarm transfer	ISM	Version 2, EAS
NT3X83AD	OAU alarm transfer (-60V version)	ISM	Version 2, EAS
NT3X83BA	LP alarm transfer & sending	ISM	LPA

In the LPA system, the OAU alarm sending function is on the NT3X83BA card. This function is on the NT3X84 card in alarm systems other than LPA. The NT3X83BA can be used in both -48V and -60V applications.

ALMSCGRP (continued)

The following table lists the SD and SC points for the NT3X83 card.

SD and SC points for NT3X83

SD point	Function	Normal state	SC point	Function	Normal state
0	ALMXFR	0	0	AXFRALM	0
1	MJXFR	0	1	REMOPEAR	0
2	MNXFR	0	2	130MONITOR (See Note)	0
3	LN101TST	0	3	TTCNTXFR	0
4	NTALMXFR	0	4	TSTLN101	0
5	EXPILDMS	0	5	Internal circuit	0
6	EXPILPWR	0	6	Internal circuit	0

Note: You use scan point 130MONITOR only for non-LPA systems (systems that do not contain the NT3X83BA card). For LPA configurations, use MONITOR.

NT3X84 - OAU alarm sending card

The OAU alarm sending (NT3X84) cards in Version 2 and EAS OAUs contain both SC and SD points. These cards contain two circuits. The even-numbered circuit contains SD points and the odd-numbered circuit contains SC points. The following table lists the versions of NT3X84 card.

NT3X84 versions

PEC	Card name	Shelf	OAS
NT3X84AA	OAU alarm sending	MTM	Version 2, EAS
NT3X84AB	OAU alarm sending	ISM	Version 2, EAS

In the LPA system, the OAU alarm sending and alarm transfer functions are combined on the NT3X83BA card.

ALMSCGRP (continued)

The following table lists SD and SC points for the NT3X84 card.

SD and SC points for NT3X84

SD point	Function	Normal state	SC point	Function	Normal state
0	Internal circuit	0	0	Internal circuit	0
1	Internal circuit	0	1	Internal circuit	0
2	Internal circuit	0	2	TONEMONITOR	0
3	LN101TST	0	3	TTCNTXFR	0
4	NTALMXFR	0	4	TSTLN101	0
5	EXPILDMS	0	5	Internal circuit	0
6	EXPILPWR	0	6	Internal circuit	0
7	Internal circuit	0	7	Internal circuit	0

NT3X85 - OAU alarm group card

The OAU alarm group (NT3X85) cards in Version 2, EAS, and LPA OAUs contain both SC and SD points. These cards contain two circuits. The even-numbered circuit contains SD points and the odd-numbered circuit contains SC points. The following table shows the versions of NT3X85 card.

NT3X85 versions

PEC	Card name	Shelf	OAS
NT3X85AA	OAU alarm group	MTM	Version 2, EAS, LPA
NT3X85AB	OAU alarm group	ISM	Version 2, EAS, LPA

The following table lists the SD and SC points for the NT3X85 card.

SD and SC points for NT3X85

SD point	Function	Normal state	SC point	Function	Normal state
0	MJOTHVIS	0	0	CRSUCFLR	0
1	MNOTHVIS	0	2	MJSUCFLR	0

ALMSCGRP (continued)**SD and SC points for NT3X85**

SD point	Function	Normal state	SC point	Function	Normal state
2	SUCFLRCR	0	2	MNSUCFLR	0
3	SUCFLRMJ	0	3	CRPREFLR	0
4	SUCFLRMN	0	4	MJPREFLR	0
5	PREFLRCR	0	5	MNPREFLR	0
6	PREFLRMJ	0	6	ALMGRP	0
7	PREFLRMN	0	7	Internal circuit	0

NT0X10AA - miscellaneous scan card

Each miscellaneous scan detector card provides 14 single-lead scan points. The card has two groups of seven scan points (0 to 6). You assign a trunk module circuit number to each scan group.

The first miscellaneous scan card has the following SC point assignments.

Scan points for first NT0X10 card

Even-numbered circuit	Odd-numbered circuit				
SC point	Function	Normal state	SC point	Function	Normal state
0	CRPWR	0	0	FSPAISA	0
1	MJPWR	0	1	FSPAISB	0
2	MNPWR	0	2	FSPAISC	0
3	PDCFAIL	0	3	FSPAISD	0
4	ABSFAIL	0	4	FSPAISE	0
5	ACDLPTST	0	5	FSPAISF	0
6	VCEALM0	0	6	AUDDIS	0

ALMSCGRP (continued)

The second miscellaneous scan card has the following SC point assignments.

Scan points for second NT0X10 card

Even-numbered circuit	Odd-numbered circuit				
SC point	Function	Normal state	SC point	Function	Normal state
0	FSPAISG	0	0	Spare	0
1	PSPAISH	0	1	Spare	0
2	PSPAISJ	0	2	Spare	0
3	FSPAISK	0	3	Spare	0
4	FSPAISL	0	4	Spare	0
5	PSPAISM	0	5	Spare	0
6	RDBALM	0	6	Spare	0

The operating company can assign the spare SC points to various unique applications.

The third miscellaneous scan card has the following SC point assignments.

Scan points for third NT0X10 card

Even-numbered circuit	Odd-numbered circuit				
SC point	Function	Normal state	SC point	Function	Normal state
0	FSPAISN	0	0	FSPAISV	0
1	PSPAISP	0	1	FSPAISW	0
2	PSPAISQ	0	2	FSPAISX	0
3	FSPAISR	0	3	FSPAISY	0
4	FSPAISS	0	4	FSPAISZ	0
5	FSPAIST	0	5	FSPAISAA	0
6	RDBALU	0	6	FSPAISBB	0

ALMSCGRP (continued)

The fourth miscellaneous scan card has the following SC point assignments.

Scan points for fourth NT0X10 card

Even-numbered circuit	Odd-numbered circuit				
SC point	Function	Normal state	SC point	Function	Normal state
0	FSPAISCC	0	0	FSPAISKK	0
1	PSPAISDD	0	1	FSPAISLL	0
2	PSPAISEE	0	2	FSPAISMM	0
3	FSPAISFF	0	3	FSPAISNN	0
4	FSPAISGG	0	4	FSPAISPP	0
5	FSPAISHH	0	5	FSPAISQQ	0
6	FSPAISJJ	0	6	FPAISR	0

The fifth miscellaneous scan card contains 14 customer-assignable scan points.

The sixth miscellaneous scan card contains 14 customer-assignable scan points.

Functional description

Table ALMSCGRP stores alarm circuit equipment, location, and card type information. This table is a head table for table ALMSC.

Table ALMSCGRP has a fixed pseudo common language location identifier (CLLI) code of OAUSC. For information on the fixed CLLI code, see the description of table CLLI.

Datafill sequence and implications

Before you assign a scan group to table ALMSCGRP, verify that the scan group has not been assigned to table SCGRP for other switching units, or to tables NWMSC and NWMSCPT.

Table size

0 to 512 tuples

ALMSCGRP (continued)

The true datafillable maximum for table ALMSCGRP is 492 tuples. The maximum size of table ALMSCGRP is 512 tuples, but 20 of these tuples are reserved for table SFWALARM. These 20 tuples do not appear in table ALMSCGRP.

The maximum number of scan points you can assign is 4096. The maximum number of scan groups you can datafill is 512.

Memory for SC groups is automatically allocated.

Datafill

The following table lists datafill for table ALMSCGRP.

Field descriptions

Field	Subfield or refinement	Entry	Explanation and action
SCGROUP		0 to 512	<p><i>Scan group</i> Enter the scan group number.</p> <p>Note: For the FSP_REMOTE_SMG4 scan function, SCGROUP should be datafilled for FSP Alarm reporting of remote MG4Ks only. It should not be used by any other co-located peripherals in the office for alarm reporting.</p>
TMTYPE		ATM, CTM, DTM, ISM, MTM, OAU, PTM, RMM, RSM, STM, TAN, TMA, TM2, TM4, TM8, or T8A	<p><i>Trunk module type</i> Enter the type of trunk module that contains the circuit.</p> <p>Note: Peripheral trunk modules (PTMs) are manufacture discontinued. PTMs that are datafilled as PTMs in table TMINV cause the failure of international 101 test lines. You must datafill PTMs as MTMs to avoid this problem.</p>
TMNO		0 to 2047	<p><i>Trunk module number</i> Enter the number of the trunk module that contains the circuit.</p> <p>If the entry in field TMTYPE is OAU, enter 0.</p> <p>If the entry in field TMTYPE is MTM, enter 0 to 255.</p> <p>If the entry in field TMTYPE is RSM, enter 99.</p>

ALMSCGRP (continued)**Field descriptions**

Field	Subfield or refinement	Entry	Explanation and action
TMCKTNO		0 to 29	<i>Trunk module circuit number</i> Enter the trunk module circuit number for the card.
CARDCODE		0X10AA 3X82AA 3X82AB 3X82AC 3X82AD 3X82AE 3X82AF 3X82AG 3X82AH 3X82AJ 3X82AK 3X82BA 3X83AA 3X83AB 3X83AC 3X83AD 3X83BA 3X84AA 3X84AB 3X85AA or 3X85AB	<i>Product engineering code</i> Enter the code (abbreviated PEC) for the alarm card. For Version 2 OAU on an MTM shelf, enter 3X82AA or 3X82AB. For EAS OAU on an MTM shelf, enter 3X82AC, 3X82AD, or 3X82AE. For Version 2 OAU on an ISM shelf, enter 3X82AF or 3X82AG. For EAS OAU on an ISM shelf, enter 3X82AH, 3X82AJ, or 3X82AK. For LPA OAU, enter 3X82BA.

Datafill example

The following example shows sample datafill for table ALMSCGRP.

MAP display example for table ALMSCGRP

SCGROUP	TMTYPE	TMNO	TMCKTNO	CARDCODE
0	MTM	0	1	3X82AA
1	MTM	1	1	3X82AA
2	MTM	0	11	3X83AA
3	MTM	0	13	3X84AA
4	MTM	0	4	0X10AA
5	MTM	0	5	0X10AA

ALMSCGRP (end)

The following example shows datafill in table ALMSCGRP in order to implement FSP Alarms for frame failures for remotely located MG4K nodes.

MAP display example for table ALMSCGRP

SCGROUP	TMTYPE	TMNO	TMCKTNO	CARDCODE
0	MTM	1	26	3X82AA

FSP Alarm reporting for remote MG4Ks

To activate the FSP Alarm reporting feature for remote MG4Ks, an appropriate Scan Card should be provisioned in the OAU slot based on the datafill in table ALMSCGRP. This scan card should not be used by any other co-located peripherals in the office for alarm reporting (i.e. it should not be physically wired).

Table history**SN06 (DMS)**

Added details of implementing FSP Alarms frame failures for remotely located MG4K nodes, supporting activity 89007540.

BASE11

Added information on the Low Power Alarm (LPA) system

BCS36

Added values 3X82AC and 3X82AD to the valid entries for field CARDCODE

ALMSD

Table name

Alarm Signal Distributor Point

Functional description

Table ALMSD identifies the function performed by each of the assigned signal distribution (SD) points in the alarm SD groups.

The table that points into table ALMSD is Alarm Signal Distributor Group (ALMSDGRP). See the description of table ALMSDGRP for more information.

The following table lists available signal distribution point functions.

Signal distribution point functions

Signal distribution point	Function
ABAUD	Alarm battery supply, audible alarm
ABOAU	Alarm battery supply, office alarm unit (OAU), visual
ABSVIS	Alarm battery supply, visual
ALMXFR	Alarm transfer
COMAUD1	Common audible, OAU
COMAUD2	Common audible, maintenance trunk module (MTM)
CRALMAUD	Critical alarm audible
CRALMVIS	Critical alarm visual
CRPWRVIS	Critical power alarm visual
EXPILDMS	Exit pilot DMS
EXPILPWR	Exit pilot power
LN101TST	101 test line
MJALMAUD1&2	Major alarm audible (1-OAU, 2-MTM)

Note: When you assign a scan point for detection of low voltage (LOWBATT1 and LOWBATT2 on the NT3X82 card), you must also assign the LOWVOLTPWR SD function.

ALMSD (continued)**Signal distribution point functions**

Signal distribution point	Function
MJALMVIS	Major alarm visual
MJOTHVIS	Major alarm, other floor, visual
MJPWRVIS	Major power alarm visual
MJVISLOOP	Major alarm visual loop
MJXFR	Major alarm transfer
MNALMAUD	Minor alarm audible
MNALMVIS	Minor alarm visual
MNOTHVIS	Minor alarm, other floor, visual
MNPWRVIS	Minor power alarm visual
MNVISLOOP	Minor alarm visual loop
MNFXR	Minor alarm transfer
LOWVOLTPWR	Low DMS office battery level
MTMFAIL	Miscellaneous trunk module failure
MTMPWR	Miscellaneous trunk module power transfer
NTALMXFR	Night alarm transfer
OAUFAIL	Office alarm unit failure
OAUFLAUD	Office alarm unit failure, audible
OAUFLVIS	Office alarm unit failure, visual
OAUVISLOOP	Office alarm unit power visual loop
PDCVIS	Power distribution center visual
PREFLRCR	Preceding floor, critical alarm
PREFLRMJ	Preceding floor, major alarm
PREFLRMN	Preceding floor, minor alarm

Note: When you assign a scan point for detection of low voltage (LOWBATT1 and LOWBATT2 on the NT3X82 card), you must also assign the LOWVOLTPWR SD function.

ALMSD (continued)**Signal distribution point functions**

Signal distribution point	Function
RDTACO	Indicates the presence of cut-off RDT alarms
RDTSD1	Remote digital terminal 1
RDTSD2	Remote digital terminal 2
RDTSD3	Remote digital terminal 3
RDTSD4	Remote digital terminal 4
RDTSD5	Remote digital terminal 5
RDTSD6	Remote digital terminal 6
RDTSD7	Remote digital terminal 7
RDTSD8	Remote digital terminal 8
RDTCRIT	Remote digital terminal critical alarm
RDTMAJOR	Remote digital terminal major alarm
RDTMINOR	Remote digital terminal minor alarm
RDTWARN	Indicates the presence of RDT warning-level alarms
SUCFLRCR	Succeeding floor, critical alarm
SUCFLRMJ	Succeeding floor, major alarm
SUCFLRMN	Succeeding floor, minor alarm
SDOC3CUTOFF	Breaks the link between the dead system alarm (DSA) and dynamic overload control (DOC) level 3 to prevent routing controls from being implemented when a simulation of DSA is done
TOPS_ECP_TAPEDEV	Traffic Operator Position System (TOPS) emergency calling present recorded on tape recorder
TOPS_ECW_AUDIBLE	TOPS emergency calling visible
SCC_CC_ALM	Central control alarm
Note: When you assign a scan point for detection of low voltage (LOWBATT1 and LOWBATT2 on the NT3X82 card), you must also assign the LOWVOLTPWR SD function.	

ALMSD (continued)

Signal distribution point functions

Signal distribution point	Function
SCC_CCS_ALM	Common channel signaling alarm
SCC_CMC_ALM	Central message controller alarm
SCC_IO_ALM	Input/output controller
SCC_NMC_ALM	Switching network alarm
SCC_CKT_ALM	Circuit limit alarm
SCC_PM_ALM	Peripheral module alarm

Note: When you assign a scan point for detection of low voltage (LOWBATT1 and LOWBATT2 on the NT3X82 card), you must also assign the LOWVOLTPWR SD function.

You use the RDT function entries RDTCRIT, RDTMAJOR, RDTMINOR, and RDTWARN to indicate the severity of the alarm. You use RDTACO to indicate the presence of cut-off RDT alarms.

Note: SD points RDTACO and RDTWARN are optional. You do not need to datafill these SD points before you datafill SD points in table RDTINV.

Datafill sequence and implications

You must datafill table ALMSDGRP before table ALMSD.

You must datafill field SDGROUP in table ALMSDGRP before you datafill SD points.

Table size

The maximum size is 4096 tuples. Memory is automatically allocated for 4096 SD points. If you do not datafill all the predefined SD points, the size of table ALMSD decreases.

ALMSD (continued)**Datafill**

The following table lists datafill for table ALMSD.

Field descriptions

Field	Subfield or refinement	Entry	Explanation and action
FUNCTION		alphanumeric (vector of up to 16 characters)	<i>Function</i> Enter the alarm function. See the first table for a list of signal distribution points.
SDGROUP		0 to 512	<i>Signal distribution group</i> Enter the signal distribution group to which the SD point belongs.
POINT		0 to 7	<i>Signal distribution point</i> Enter the signal distribution point number within the SD group.
NORMALST		0 to 1	<i>Normal state</i> Enter the normal state of the SD point. Enter 0 (zero) if the SD point is normally off or open. Enter 1 if the SD point is normally on or closed.
AUDIBLE		Y or N	<i>Audible</i> Enter Y (yes) if the SD point resets when you operate the audible alarm reset key; otherwise, enter N (no). Note: This field must always contain N for the SD points associated with RDT alarms. Table control software disallows a Y entry.
LAMPTEST		Y or N	<i>Lamp test</i> Enter Y if the SD point is included in the lamp test; otherwise, enter N.

Datafill example

The following example applies to the Office Alarm System Version 1. The example shows the SD assignments for the alarm SD point record you require in all switching units.

ALMSD (continued)**MAP display example for table ALMSD**

FUNCTION	SDGROUP	POINT	NORMALST	AUDIBLE	LAMPTEST
EXPILPWR	0	1	0	N	N
SUCFLRMJ	0	2	0	N	N
SUCFLRPF	0	3	0	N	N
PREFLRNM	0	4	0	N	N
PREFLRMJ	0	5	0	N	N
PREFLRPF	0	6	0	N	N
EXPILDMS	1	0	0	N	N
NTALMXFR	1	1	0	N	N
LN101TST	1	2	0	N	N
ALMXFR	1	3	0	N	N
MJXFR	1	4	0	N	N
MNXFR	1	5	0	N	N
SCC_CCS_ALM	2	0	0	N	N
OAUFALL	2	2	0	Y	N
MJALMAUD	2	3	0	Y	N
MNALMAUD	2	4	0	Y	N
ABAUD	2	5	0	Y	N
TRKGPALM	2	6	0	N	N
CRPWRVIS	4	0	0	N	Y
MJPWRVIS	4	1	0	N	Y
MNPWRVIS	4	2	0	N	Y
CRALMVIS	4	3	0	N	Y
MJALMVIS	4	4	0	N	Y
MNALMVIS	4	5	0	N	Y
PDCVIS	4	6	0	N	Y
MJOTHVIS	5	0	0	N	Y
MNOTHVIS	5	1	0	N	Y
ABOAU	5	2	0	N	Y
ABPDC	5	3	0	N	N
MTMFAIL	6	0	1	N	N
MTMPWR	6	1	0	N	N
OAUFLLAUD	6	2	0	Y	N
OAUFLLVIS	6	3	0	N	N

The following two examples apply to Office Alarm System Version 2.

The first example shows datafill for a small office.

ALMSD (continued)**MAP display example for table ALMSD**

FUNCTION	SDGROUP	POINT	NORMALST	AUDIBLE	LAMPTEST
OAUFAIL	0	0	1	N	N
OAUPWR	0	1	1	N	N
ABOAU	0	4	0	Y	Y
COMAUD1	0	5	0	N	N
MTMFAIL	1	0	1	N	N
MTMPWR	1	1	0	N	N
OAUFLVIS	1	4	0	Y	N
COMAUD2	1	5	0	N	N
LN101TST	2	3	0	N	N
NTALMXFR	2	4	0	N	N
EXPILDMS	2	5	0	N	N
EXPILPWR	2	6	0	N	N
CRALMVIS	3	0	0	Y	Y
MJALMVIS	3	1	0	Y	Y
MNALMVIS	3	2	0	Y	Y
PDCVIS	3	3	0	Y	Y
ABSVIS	3	4	0	N	N
CRPWRVIS	4	0	0	N	Y
MJPWRVIS	4	1	0	N	Y
MNPWRVIS	4	2	0	N	Y
CRVISLOOP	4	3	0	N	N
MJVISLOOP	4	4	0	N	N
MNVISLOOP	4	5	0	N	N
OAUVISLOOP	4	6	0	N	N

The second example shows datafill for a large office.

ALMSD (continued)**MAP display example for table ALMSD**

FUNCTION	SDGROUP	POINT	NORMALST	AUDIBLE	LAMPTEST
OAUFFAIL	0	0	1	N	N
OAUPWR	0	1	1	N	N
MJALMAUD1	0	2	0	Y	N
ABAUD	0	3	0	Y	Y
ABOAU	0	4	0	N	N
COMAUD1	0	5	0	Y	N
MTMFAIL	1	0	1	N	N
MTMPWR	1	1	0	N	N
MJALMAUD2	1	2	0	Y	N
OAUFLAUD	1	3	0	Y	N
OAUFLVIS	1	4	0	N	N
COMAUD2	1	5	0	Y	N
ALMXFR	2	0	0	N	N
MJXFR	2	1	0	N	N
MNXFR	2	2	0	N	N
LN101TST	2	3	0	N	N
NTALMXFR	2	4	0	N	N
EXPILDMS	2	5	0	N	N
EXPILPWR	2	6	0	N	N
MJOTHVIS	3	0	0	N	Y
MNOTHVIS	3	1	0	N	Y
SUCFLRCR	3	2	0	N	N
SUCFLRMJ	3	3	0	N	N
SUCFLRMN	3	4	0	N	N
PREFLRCR	3	5	0	N	N
PREFLRMJ	3	6	0	N	N
PREFLRMN	3	7	0	N	N
CRALMVIS	4	0	0	N	Y
MJALMVIS	4	1	0	N	Y
MNALMVIS	4	2	0	N	Y
PDCVIS	4	3	0	N	Y
ABSVIS	4	4	0	N	Y
CRALMAUD	4	5	0	Y	N
MNALMAUD	4	6	0	Y	N
CRPWRVIS	5	0	0	N	Y
MJPWRVIS	5	1	0	N	Y
MNPWRVIS	5	2	0	N	Y
CRVISLOOP	5	3	0	N	N
MJVISLOOP	5	4	0	N	N
MNVISLOOP	5	5	0	N	N
OAUVISLOOP	5	6	0	N	N
SDOC3CUTOFF	6	0	0	N	N

The following example shows possible datafill for RDT SD points.

MAP display example for table ALMSD

FUNCTION	SDGROUP	POINT	NORMALST	AUDIBLE	LAMPTEST
RDTSD1	4	1	0	N	Y
RDTSD2	4	2	0	N	Y
RDTSD8	4	3	0	N	Y

The following example shows possible datafill for FSP Alarms for frame failures for remotely located MG4K nodes.

MAP display example for table ALMSD

FUNCTION	SDGROUP	POINT	NORMALST	AUDIBLE	LAMPTEST
MJALMVIS 0		1	0	Y	Y

Table history

SN06 (DMS)

Added MAP example for FSP Alarms for frame failures for remotely located MG4K nodes supporting activity 89007540.

BASE11

Changes associated with the Low Power Alarm (LPA) system

ALMSDGRP

Table name

Alarm Signal Distributor Group

Overview

The following office alarm systems (OAS) exist:

- Version 1
- Version 2
- Version 2 Enhanced Alarm System (EAS)
- Low Power Alarm (LPA) system

The DMS alarm systems detect and report failures and service degradations. The alarm system is a set of hardware devices and software modules that provide the following:

- visual (lights) and audible (tones) indication of alarm conditions
- transfer of critical, major, and minor alarms to remote sites
- data loops for a portable MAP terminal
- battery power feed for telephone headset communication within the office with the following:
 - frame supervisory panel (FSP)
 - maintenance supervisory panel (MSP)
 - main distribution frame (MDF)
 - operator MAP terminal access points

The alarm system uses scan (SC) points and signal distribution (SD) points to monitor and report the alarm status of each equipment row, to a maximum of 40 rows. Scan points detect voltage, ground, closed-loop, or open-loop conditions. Signal distribution points transfer alarm indications to alarm panels and other equipment. Hardware switch settings and datafill in tables ALMSCGRP, ALMSC, ALMSDGRP, and ALMSD define the scan and signal distribution points.

Some hardware is specific to one alarm system version. Other hardware, like scan and signal distribution cards, is common to all versions.

The office alarm unit (OAU) in Version 1 OAS is on a maintenance trunk module (MTM) shelf. All alarm detection and control hardware is in the OAU and an associated (standby) MTM. The Version 1 OAU uses NT2X41, NT2X42, and NT2X43 cards.

ALMSDGRP (continued)

The OAU is dedicated to the alarm system. The standby MTM contains the alarm system backup circuits that generate an alarm if the OAU fails. The standby MTM can also contain equipment not related to the alarm system.

In the Version 2 OAS and the EAS, the primary OAU and the standby unit are on an MTM or ISM shelf.

In the LPA system, the primary OAU and the standby unit are on an ISM shelf.

In Version 2 and later OAS, you can provision the alarm SC and SD hardware on various MTM or ISM shelves throughout the office.

For further information on the OAS, refer to *Alarm System Description*, 297-1001-122.

NT3X82 - OAU dead system card

The OAU dead system (NT3X82) cards used in Version 2, EAS, and LPA OAU contain both SC and SD points. These cards contain two circuits. The even-numbered circuit contains SD points and the odd-numbered circuit contains SC points. The following table shows the versions of NT3X82 card.

NT3X82 versions

PEC	Card name	Shelf	OAS
NT3X82AA	OAU dead system with unique audibles	MTM	Version 2
NT3X82AB	OAU dead system with common audibles	MTM	Version 2
NT3X82AC	OAU dead system with unique audibles	MTM	EAS
NT3X82AD	OAU dead system with common audibles	MTM	EAS
NT3X82AE	OAU dead system with unique audibles (-60V version)	MTM	EAS
NT3X82AF	OAU dead system with unique audibles	ISM	Version 2
NT3X82AG	OAU dead system with common audibles	ISM	Version 2
NT3X82AH	OAU dead system with unique audibles	ISM	EAS
NT3X82AJ	OAU dead system with common audibles	ISM	EAS
NT3X82AK	OAU dead system with unique audibles (-60V version)	ISM	EAS
NT3X82BA	LPA dead system with audibles and IATC	ISM	LPA

ALMSDGRP (continued)

In the LPA system, the OAU common and unique audibles are combined on the NT3X82BA card. The NT3X82BA also contains the inactive timing circuit (IATC).

The following table lists the SD and SC points for NT3X82AA, NT3X82AC, NT3X82AE, NT3X82AF, NT3X82AH, or NT3X82BA card in an OAU.

SD and SC points for NT3X82AA, NT3X82AC, NT3X82AE, NT3X82AF, NT3X82AH, or NT3X82BA in OAU

SD point	Function	Normal state	SC point	Function	Normal state
0	OAUFAIL	0	0	ABMTMFL	0
1	OAUPWR	0	1	AUDARO	0
2	MJALMAUD1	0	2	LOWBATT1	0
3	ABAUD	0	3	Not used	0
4	ABOAU	0	4	FEEDLOSS1	0
5	COMAUD	0	5	Internal circuit	0
6	Internal circuit	0	6	Internal circuit	0
7	Internal circuit	0	7	Internal circuit	0

The following table lists the SD and SC points for the NT3X82AA, NT3X82AC, NT3X82AE, NT3X82AF, NT3X82AH, or NT3X82BA cards in a standby MTM or ISM.

SD and SC points for NT3X82AA, NT3X82AC, NT3X82AE, NT3X82AF, NT3X82AH, or NT3X82BA in standby MTM or ISM

SD point	Function	Normal state	SC point	Function	Normal state
0	MTMFAIL	0	0	ABOAUFL	0
1	MTMPWR	0	1	AUDARM	0
2	MJALMAUD2	0	2	LOWBATT2	0
3	OAUFLAUD	0	3	Internal circuit	0
4	OAUFLVIS	0	4	FEEDLOSS2	0
5	COMAUD	0	5	Internal circuit	0

4 Data schema

ALMSDGRP (continued)

SD and SC points for NT3X82AA, NT3X82AC, NT3X82AE, NT3X82AF, NT3X82AH, or NT3X82BA in standby MTM or ISM

SD point	Function	Normal state	SC point	Function	Normal state
6	Internal circuit	0	6	Internal circuit	0
7	Internal circuit	0	7	Internal circuit	0

The following table lists the SD and SC points for NT3X82AB, NT3X82AD, NT3X82AG, or NT3X82AJ cards in an OAU.

SD and SC points for NT3X82AB, NT3X82AD, NT3X82AG, or NT3X82AJ in OAU

SD point	Function	Normal state	SC point	Function	Normal state
0	OAUFAIL	0	0	ABMTMFL	0
1	OAU PWR	0	1	AUDARO	0
2	Internal circuit	0	2	LOWBATT1	0
3	Internal circuit	0	3	Internal circuit	0
4	OAUFLVIS	0	4	FEEDLOSS1	0
5	COMAUD1	0	5	Internal circuit	0
6	Internal circuit	0	6	Internal circuit	0

The following table lists the SD and SC points for NT3X82AB, NT3X82AD, NT3X82AG, or NT3X82AJ cards in a standby MTM or ISM.

SD and SC points for NT3X82AB, NT3X82AD, NT3X82AG, or NT3X82AJ in standby MTM or ISM

SD point	Function	Normal state	SC point	Function	Normal state
0	MTMFAIL	0	0	ABOAUFL	0
1	MTMPWR	0	1	AUDARM	0
2	Internal circuit	0	2	LOWBATT2	0
3	Internal circuit	0	3	Internal circuit	0
4	OAUFLVIS	0	4	FEEDLOSS2	0

ALMSDGRP (continued)**SD and SC points for NT3X82AB, NT3X82AD, NT3X82AG, or NT3X82AJ in standby MTM or ISM**

5	COMAUD2	0	5	Internal circuit	0
6	Internal circuit	0	6	Internal circuit	0

NT3X83 - OAU alarm transfer card

The OAU alarm transfer (NT3X83) cards in Version 2, EAS, and LPA OAU systems contain SC and SD points. These cards contain two circuits. The even-numbered circuit contains SD points and the odd-numbered circuit contains SC points. The following table shows the versions of NT3X83 card.

NT3X83 versions

PEC	Card name	Shelf	OAS
NT3X83AA	OAU alarm transfer	MTM	Version 2, EAS
NT3X83AB	OAU alarm transfer (-60V version)	MTM	Version 2, EAS
NT3X83AC	OAU alarm transfer	ISM	Version 2, EAS
NT3X83AD	OAU alarm transfer (-60V version)	ISM	Version 2, EAS
NT3X83BA	LP alarm transfer & sending	ISM	LPA

In the LPA system, the OAU alarm sending function is on the NT3X83BA card. This function is on the NT3X84 card in alarm systems other than LPA. The NT3X83BA can be used in both -48V and -60V applications.

The following table lists the SD and SC points for the NT3X83 card.

SD and SC points for NT3X83

SD point	Function	Normal state	SC point	Function	Normal state
0	ALMXFR	0	0	AXFRALM	0
1	MJXFR	0	1	REMOPEAR	0
2	MNXFR	0	2	130MONITOR	0
3	LN101TST	0	3	TTCNTXFR	0

ALMSDGRP (continued)**SD and SC points for NT3X83**

SD point	Function	Normal state	SC point	Function	Normal state
4	NTALMXFR	0	4	TSTLN101	0
5	EXPILDMS	0	5	Internal circuit	0
6	EXPILPWR	0	6	Internal circuit	0

NT3X84 - OAU alarm sending card

The OAU alarm sending (NT3X84) cards in Version 2 and EAS OAUs contain both SC and SD points. These cards contain two circuits. The even-numbered circuit contains SD points and the odd-numbered circuit contains SC points. The following table lists the versions of NT3X84 card.

NT3X84 versions

PEC	Card name	Shelf	OAS
NT3X84AA	OAU alarm sending	MTM	Version 2, EAS
NT3X84AB	OAU alarm sending	ISM	Version 2, EAS

In the LPA system, the OAU alarm sending and alarm transfer functions are combined on the NT3X83BA card.

The following table lists SD and SC points for the NT3X84 card.

SD and SC points for NT3X84

SD point	Function	Normal state	SC point	Function	Normal state
0	Internal circuit	0	0	Internal circuit	0
1	Internal circuit	0	1	Internal circuit	0
2	Internal circuit	0	2	TONEMONITOR	0
3	LN101TST	0	3	TTCNTXFR	0
4	NTALMXFR	0	4	TSTLN101	0
5	EXPILDMS	0	5	Internal circuit	0

ALMSDGRP (continued)**SD and SC points for NT3X84**

SD point	Function	Normal state	SC point	Function	Normal state
6	EXPILPWR	0	6	Internal circuit	0
7	Internal circuit	0	7	Internal circuit	0

NT3X85 - OAU alarm group card

The OAU alarm group (NT3X85) cards in Version 2, EAS, and LPA OAUs contain both SC and SD points. These cards contain two circuits. The even-numbered circuit contains SD points and the odd-numbered circuit contains SC points. The following table shows the versions of NT3X85 card.

NT3X85 versions

PEC	Card name	Shelf	OAS
NT3X85AA	OAU alarm group	MTM	Version 2, EAS, LPA
NT3X85AB	OAU alarm group	ISM	Version 2, EAS, LPA

The following table lists the SD and SC points for the NT3X84 card.

SD and SC points for NT3X85

SD point	Function	Normal state	SC point	Function	Normal state
0	MJOTHVIS	0	0	CRSUCFLR	0
1	MNOTHVIS	0	2	MJSUCFLR	0
2	SUCFLRCR	0	2	MNSUCFLR	0
3	SUCFLRMJ	0	3	CRPREFLR	0
4	SUCFLRMN	0	4	MJPREFLR	0
5	PREFLRCR	0	5	MNPREFLR	0
6	PREFLRMJ	0	6	ALMGRP	0
7	PREFLRMN	0	7	Internal circuit	0

ALMSDGRP (continued)**NT2X57 - signal distribution card**

Each NT2X57 card provides 16 SD points. The card is divided into two SD groups. Each SD group has eight SD points (0 to 7). You assign a trunk module circuit number to each scan group.

The following table shows the SD point assignments for the first NT2X57 card. Each of the other NT2X57 cards has 14 customer-assignable SD points.

SD points for the first NT2X57

SD point	Function	Normal state	SD point	Function	Normal state
0	CRALMVIS	0	0	CRPWRVIS	0
1	MJALMVIS	0	1	MJPWRVIS	0
2	MNALMVIS	0	2	MNPWRVIS	0
3	PDCVIS	0	3	CRVISLOOP	0
4	ABSVIS	0	4	MJVISLOOP	0
5	CRALMAUD	0	5	MNVISLOOP	0
6	MNALMAUD	0	6	OAUVIS-LOOP	0
7	Internal circuit	0	7	Internal circuit	0

Functional description

Table ALMSDGRP stores alarm circuit equipment, location, and card type information. This table is a head table for table ALMSD.

Table ALMSDGRP has a fixed pseudo common language location identifier (CLLI) code of OAUSD. For information on the fixed CLLI code, see the description of table CLLI.

Datafill sequence and implications

Before you assign an SD group in table ALMSDGRP, verify that you have not already assigned the SD group in table SDGRP, SITE, NWMSD and NWMSD.NWMSDPT, or TMINV.

Table size

0 to 512 tuples

The maximum number of SD points you can assign is 1024.

ALMSDGRP (continued)

Memory for SD groups is automatically allocated.

Datafill

The following table lists datafill for table ALMSDGRP.

Field descriptions

Field	Subfield or refinement	Entry	Explanation and action
SDGROUP		0 to 512	<i>Signal distributor group</i> Enter the signal distribution group number.
TMTYPE		ATM, CTM, DTM, ISM, MTM, OAU, PTM, RMM, RSM, STM, TAN, TMA, TM2, TM4, TM8, orT8A	<i>Trunk module type</i> Enter the type of trunk module that contains the circuit. Note: Peripheral trunk modules (PTMs) are manufacture discontinued. PTMs that are datafilled as PTMs in table TMINV cause the failure of international 101 test lines. You must datafill PTMs as MTMs to avoid this problem.
TMNO		0 to 2047	<i>Trunk module number</i> Enter the number of the trunk module that contains the circuit. If the entry in field TMTYPE is OAU, enter 0. If the entry in field TMTYPE is MTM, enter 0 to 255. If the entry in field TMTYPE is RSM, enter 99.

ALMSDGRP (continued)**Field descriptions**

Field	Subfield or refinement	Entry	Explanation and action
TMCKTNO		0 to 29	<i>Trunk module circuit number</i> Enter the trunk module circuit number for the card.
CARDCODE		2X57AA	<i>Product engineering code</i>
		3X82AA	Enter the code (abbreviated PEC) for the alarm card.
		3X82AB	
		3X82AC	
		3X82AD	For Version 2 OAU on an MTM shelf, enter 3X82AA or 3X82AB.
		3X82AE	
		3X82AF	For EAS OAU on an MTM shelf, enter 3X82AC, 3X82AD, or 3X82AE.
		3X82AG	
		3X82AH	For Version 2 OAU on an ISM shelf, enter 3X82AF or 3X82AG.
		3X82AJ	
		3X82AK	
		3X82BA	For EAS OAU on an ISM shelf, enter 3X82AH, 3X82AJ, or 3X82AK.
		3X83AA	
		3X83AB	
		3X83AC	For LPA OAU, enter 3X82BA.
		3X83AD	
		3X83BA	
		3X84AA	
		3X84AB	
		3X85AA or	
		3X85AB	

Datafill example

The following example shows datafill in table ALMSDGRP for OAS Version 1.

ALMSDGRP (continued)**MAP display example for table ALMSDGRP**

SDGROUP	TMTYPE	TMNO	TMCKTNO	CARDCODE
0	OAU	0	0	2X57AA
1	OAU	0	1	2X57AA
2	OAU	0	2	2X57AA
3	OAU	0	3	2X57AA
4	OAU	0	4	2X57AA
5	OAU	0	5	2X57AA
6	MTM	4	2	2X57AA

Note: The entries for SD groups 0 to 5 are always required. These entries are related to the OAU.

Note: All remaining SD groups 6 to 255 depend on the function of the SD group.

For information on individual SD point assignments, see the description of table ALMSD.

SD group 6 must be mounted on the same MTM as the office alarm card #3 (NT2X43).

The next two examples are for OAS Version 2.

The first example is for a small office with the following features:

- Dead System Alarm with Common Audible
- Alarm Sending and Checking
- Frame Supervisory Panel Alarm for Two Aisles

ALMSDGRP (continued)**MAP display example for table ALMSDGRP**

SDGROUP	TMTYPE	TMNO	TMCKTNO	CARDCODE
0	MTM	0	0	3X82AA
1	MTM	4	0	3X82AB
2	MTM	0	2	3X84AA
3	MTM	0	6	2X57AA
4	MTM	0	7	2X57AA

The second example is for a large office with the following alarm features:

- Dead System Alarm with Unique Audible
- Remote Alarm Transfer
- Alarm Grouping
- Frame Supervisory Panel Alarm for Seven Aisles
- Enhanced Network Management

MAP display example for table ALMSDGRP

SDGROUP	TMTYPE	TMNO	TMCKTNO	CARDCODE
0	MTM	0	0	3X82AA
1	MTM	4	0	3X82AA
2	MTM	0	4	3X83AA
3	MTM	0	6	3X85AA
4	MTM	0	10	2X57AA
5	MTM	0	11	2X57AA
6	MTM	0	12	2X57AA

The following example shows datafill in table ALMSDGRP in order to implement FSP Alarms for frame failures for remotely located MG4K nodes.

MAP display example for table ALMSDGRP

SDGROUP	TMTYPE	TMNO	TMCKTNO	CARDCODE
0	MTM	1	26	3X82AA

Table history**SN06 (DMS)**

Added sample datafill for implementing FSP Alarm frame failures for remotely located MG4K nodes supporting activity 89007540.

BASE11

Added information on the Low Power Alarm (LPA) system

BCS36

Deleted value 2X55AA from the valid entries for field CARDCODE

Added values 3X82AC and 3X82AD to the valid entries for field CARDCODE

ALTSCHED

Table name

Automatic Line Testing Schedule Table

Functional description

Table ALTSCHED contains the defined schedules for automatic line testing (ALT) procedures. ALT allows the testing of a number of subscriber lines without manual intervention once the tests are defined and started.

The test definition requires the following data:

- the type of test
- the type of line on which the defined test runs
- a range of line equipment numbers (LEN) to test
- the start and stop times of the test on a daily basis
- the user identity that last modified or added the test

The key to this table is a 6- to 12-character test identifier that is unique and datafilled by the operating company. The key is also used by the ALT levels of the MAP (maintenance and administration position) terminals to identify which defined test to access, define, or update. The first six characters of the test identifier cannot be MANUAL. This restriction is to avoid confusion with manual ALT definition of tests as the test identifier has MANUAL as the first six characters.

Line tests

The tests that can be defined are

- on-hook balance network (BAL)
- board-to-board (BBT)
- circuit test (CKTTST)
- diagnostics (DIAG)
- line insulation (LIT)
- short diagnostics (SDIAG)

The group of lines to test is a range using a start LEN and an end LEN (fields STARTLEN and ENDLEN).

ALTSCHED (continued)

The ALT tests support ISDN loops for the ISDN automatic modem insertion (AMI) line card.

Note: No additional enhancements are required for the BAL, DIAG, and SDIAG tests.

Board-to-board test

The application board-to-board test (BBT) line concentrating device cutover (LCDCUT) modifies table control of table ALTSCHED to suit BBT testing requirements. The scheduling of tests is facilitated by allowing the end user to define a test and run it at a later date.

Circuit test enhancements

If keyset options are not available in the load, the circuit test value (CKTTST) for filed test (field TEST) is blanked out at initial program load (IPL) time and the refinements for CKTTST, fields NUMMSG, SERVICES, and LOCATION, are not bound in.

Circuit tests improve the maintainability of keyset loop and terminals. Keysets include electronic business sets (EBS), data units (DATA), asynchronous interface modules (AIM), and integrated bit error rate test (IBERT) lines. The enhanced circuit test capabilities permit better evaluation of the keyset loop, and for EBS and DATA lines, the operational status of the terminal on that loop.

Circuit tests do not include enhancing circuit testing capabilities on integrated voice and data (IVD) lines.

Line insulation test

The line insulation test (LIT) covers the ISDN U-line card (ISLC), but is not applicable to the S/T-ISLC.

When the LIT capacitance test is performed on an ISDN line, the cutoff relay on the line card is operated. This causes a 1-min outage in service. The capacitance test is not performed as part of LIT on ISDN lines.

The default values for the LIT parameters are supplemented with values that are appropriate for ISDN lines. These parameters specify the voltage at which the voltage tests are performed, as well as the tip-to-ground, ring-to-ground, and tip-to-ring resistance thresholds. Command LITINFO displays the system default values for the LIT parameters at the LIT level of the MAP terminal.

Modification of data tuples

The data tuples for table ALTSCHED are added, updated, and deleted using the table editor or data modification order program (DMOPRO).

ALTSCHED (continued)

Data tuples can also be added, updated, and deleted from the ALT MAP level. Command SUBMIT must be issued to add the tuple to table ALTSCHED. Command REMOVE at the ALT MAP level deletes a test identifier tuple from table ALTSCHED.

When a new tuple is added to table ALTSCHED, either by DMOPRO or the ALT MAP level, the status of the test identifier must be entered. This indicates to the ALT whether the test identifier is ready to run tests or stopped. If tuples are added from the ALT MAP level, the initial status of the test identifier is stopped. Command START can set the test identifier to ready-to-run or else field STARTED in table ALTSCHED can be set to Y (yes).

The test identifier status must be stopped to delete a tuple from table ALTSCHED.

Aspects of table ALTSCHED

Additional information concerning table ALTSCHED is provided below.

- The ALT, because it is table defined, does not place any restrictions on the number of users who can define tests.
- A test identifier that is overridden does not start up until the override time expires. If the test identifier is overridden, stopped, and then restarted, the override no longer applies.
- The ALT allows start and stop times on a daily (within 24 h) or time period basis (over 24 h). For example, MON 23:00 to TUE 06:00 or FRI 01:00 through to SUN 06:00. This allows more flexibility to maximize test time based on LEN availability.
- The ALT defines a range of LENs, which includes one or more sites to be defined for testing.
- A test identifier that already exists in table ALTSCHED has an extension test associated with it. The extension test identifier uses the primary test identifier's data, but has different scheduled times. For example, if a group of LENs, HOST 02 0 10 00 through HOST 10 0 05 31, have known quiet periods twice a day (for example, 01:00 to 06:00 and 11:00 to 15:00), then the tests are defined as shown in table .

ALTSCHED (continued)**Test identifier example**

Test	Test specifics
Test A	Defines its test for times 01:00 to 06:00 and LENSs HOST 02 0 10 00 through HOST 10 0 05 31.
Test B	Defines its test for times 11:00 to 15:00 and associates with Test A LENSs.

Datafill sequence and implications

The following tables must be datafilled before ALTSCHED:

- LNINV
- MTAHORIZ
- MTAVERT
- CLLIMITCE.DIAGDATA

Office parameter CIRCUIT_TEST_NUMBER_MESSAGES in table OFCVAR is used in conjunction with table ALTSCHED.

Table size

0 to 500 tuples

Datafill

The following table lists datafill for table ALTSCHED.

Field descriptionsName of table (Sheet 1 of 2)

Field	Subfield or refinement	Entry	Explanation and action
ALTTSTID		alphanumeric (6 to 12 characters)	Automatic line test identifier. Enter a test identifier to identify a unique test. The first character must be alphabetic and the first six characters cannot be MANUAL.

ALTSCHED (continued)

Field descriptionsName of table (Sheet 2 of 2)

Field	Subfield or refinement	Entry	Explanation and action
TESTDEF		see subfield	Test definition. This field consists of subfield EXTTST and refinements PRMTSTID and PRIMDEF which define the automatic line testing (ALT) test boundary conditions.
	EXTTST	Y or N	<p>Extension test. The entry in this field indicates whether this test is an extension of the times that a previously defined test can run.</p> <p>Enter Y (yes) if this test is an extension and datafill refinement PRMTSTID.</p> <p>Otherwise, enter N (no) and datafill refinement PRIMDEF.</p>

EXTTST = Y

If the entry in field EXTTST is Y, datafill refinement PRMTSTID as described below.

Field descriptions for conditional datafill

Field	Subfield or refinement	Entry	Explanation and action
	PRMTSTID	alphanumeric (6 to 12 characters)	Previously defined test. If the entry in field EXTTST is Y, enter a test identifier to identify a unique test that was previously defined and continue datafill with field SCHDTIME. All other fields are obtained from the previously defined test of which this test is an extension.

ALTSCHED (continued)

EXTTST = N

If the entry in field EXTTST is N, datafill refinement PRIMDEF as described below.

Field descriptions for conditional datafill (Sheet 1 of 2)

Field	Subfield or refinement	Entry	Explanation and action
	PRIMDEF	see subfields	Primary definition. This field consists of subfields TEST, LINETYPE, STARTLEN, and ENDLEN.

ALTSCHED (continued)**Field descriptions for conditional datafill (Sheet 2 of 2)**

Field	Subfield or refinement	Entry	Explanation and action
	TEST	BAL, BBT, CKTTST, DIAG, LIT, or SDIAG	<p>Test type. Enter the test type required.</p> <p>Enter BAL for the on-hook balance network test and datafill field LINETYPE below, then go to field STARTLEN in section All values of field TEST.</p> <p>Enter BBT for the board-to-board test, then go to subfield TEST_TYPE.</p> <p>Enter CKTTST for the circuit test and datafill field LINETYPE below, then datafill refinements NUMMSG, SERVICE, and LOCATION starting.</p> <p>Enter DIAG for the diagnostics test and datafill field LINETYPE below, then go to field STARTLEN in section All values of field TEST.</p> <p>Enter LIT for the line insulation test and datafill field LINETYPE below, then datafill refinements EMF, RESTG, RESRG, RESTR, and CAP.</p> <p>Enter SDIAG for the short diagnostics test and datafill field LINETYPE below, then go to field STARTLEN in section All values of field TEST..</p>
	LINETYPE	ALL, ISDN, or STANDARD	<p>Line type. Enter one of the following line types on which the defined ALT test runs.</p> <ul style="list-style-type: none"> • ALL (all lines are considered for testing) • ISDN (only ISDN lines are considered for testing) • STANDARD (only non-ISDN lines are considered for testing) <p>Lines that do not fall into the line type specified are not tested. The default value is STANDARD.</p>

TEST = BBT

If the entry in field TEST is BBT, datafill refinements TEST_TYPE, TEST_ORDER, STARTLINE, ENDLIN, STARTLINE_OLD_OFFICE,

ALTSCHED (continued)

BBT_SET_NUM, BBT_TEST_TIME, USERID, STARTED, and LOGFORM as described below.

Field descriptions for conditional datafill (Sheet 1 of 2)

Field	Subfield or refinement	Entry	Explanation and action
	TEST_TYPE	BASIC, START, CLASS, or ALL	Test type. This subfield specifies the type of test to be run on the lines of the TESTID. The options are: BASIC to test for continuity, absence of tip and ring lead reversals; START to perform a BASIC test plus the START assignment on the line; CLASS to perform a BASIC test plus a class of service test; and ALL to perform all three tests providing each test is successfully completed before proceeding to the next test.
	TEST_ORDER	BY_DN or BY_LEN	Test order. This subfield defines the list of lines to be tested by DN or LEN.
	STARTLINE	numeric	Startline. This subfield defines the first line in the block of lines to begin testing. For example, the start DN of a range of DNs to be tested in the new office.
	ENDLINE	numeric	Endline. This subfield is the end DN of the range of DNs to be tested in the new office. The test restarts after this end line has been tested.
	STARTLINE_ OLD_ OFFICE	numeric	Startline of the old office. This subfield is the starting DN of a range of DNs to be tested in the old office. The DN is incremented by one each time a DN in the new office is tested. This continues until the range specified for new start DN and new end DN is reached.
	BBT_SET_ NUMBER	numeric	Board-to-board test set number. This subfield is the number of the ABBT test unit performing the types of tests to be specified.
	BBT_TEST_ TIME	see subfields	Board-to-board test time. This subfield contains the vectors STARTIME and STOPTIME. Each vector consists of the year, month, day, hour, and minute.

ALTSCHED (continued)**Field descriptions for conditional datafill (Sheet 2 of 2)**

	YEAR	1993 to 9999	Year to start or stop the test. This subfield specifies the year to start or stop the test.
	MONTH	1 to 12	Month to start or stop the test. This subfield specifies the month to start or stop the test.
	DAY	1 to 31	Day to start or stop the test. This subfield specifies the date when the test should start or stop.
	HOUR	00 to 23	Hour to start or stop the test. This field specifies the hour of the day when the test should start or stop.
	MINUTE	00 to 59	Minute to start or stop the test. This field specifies the minute of the hour when the test should start or stop.
USERID		alphanumeric (1 to 16 characters)	User identification. This field specifies the ID of the user who defined or last modified the table. The user ID, last used to update the tuple on the ACTIVE side remains in this field, not the user on the INACTIVE side. The default value is X.
STARTED		N or Y	Started. This field specifies whether the scheduler is allowed to start the test at the next time slot.
LOGFORM		SUMMARY or FULL	Log format. This field specifies which type of ALT logs to print at the completion of testing. Enter FULL for the long format of the logs. Enter SUMMARY for the short format of the logs.

ALTSCHED (continued)**TEST = CKTTST**

If the entry in field TEST is CKTTST, datafill refinements NUMMSG, SERVICE, and LOCATION as described below.

Field descriptions for conditional datafill

Field	Subfield or refinement	Entry	Explanation and action
	NUMMSG	1 to 50	Number of messages. Enter the number of messages to send during the circuit test.
	SERVICE	ALL, DATA, or VOICE	Types of keyset lines to test. Enter one of the following values: <ul style="list-style-type: none"> • ALL (test all keyset lines) • DATA (test only data lines [DATA], asynchronous interface modules [AIM], and integrated bit error rate test [IBERT] lines) • VOICE (test only voice lines and electronic business sets [EBS])
	LOCATION	LINECARD or TERMINAL	Location where circuit test is run. Enter one of the following values: <ul style="list-style-type: none"> • LINECARD (run the circuit test at the line card) • TERMINAL (run the circuit test at the terminal. If the test is run on an AIM or IBERT line, the circuit test runs at the line card [LINECARD] regardless) <p>Go to field STARTLEN in section All values of field TEST.</p>

ALTSCHED (continued)**TEST = LIT**

If the entry in field TEST is LIT, datafill refinements EMF, RESTG, RESRG, RESTR, and CAP as described below.

Field descriptions for conditional datafil (Sheet 1 of 6)

Field	Subfield or refinement	Entry	Explanation and action
	EMF	see subfield	Electromagnetic field. This refinement consists of subfield TSTEMF and refinements DCVOLTLIMIT and ACVOLTLIMIT.
	TSTEMF	Y or N	<p>Test for foreign AC or DC. Enter Y if a test for foreign alternating current (AC) or direct current (DC) voltages on tip-to-ground (TG) and ring-to-ground (RG) is required. Datafill refinements DCVOLTLIMIT and ACVOLTLIMIT. If the refinements are not datafilled, the default values for each refinement is used.</p> <p>Otherwise, enter N. Go to field RESTG.</p> <p>The default value is Y.</p>
	DCVOLTLIMIT	see subfield	DC voltage. This field consists of subfield DCDFT and refinement DCVLIMIT.
	DCDFT	Y or N	<p>DC voltage default. If the entry in field TSTEMF is Y, and if a system default value for the LIT EMF DC V display at the LIT level of a MAP display is used, enter Y. Go to field ACVOLTLIMIT.</p> <p>If the entry in field TSTEMF is Y and the operating company personnel supply the value used for the LIT EMF DC V display at the LIT level of a MAP display, enter N and datafill refinement DCVLIMIT.</p> <p>The default value is N.</p> <p>Note: To display the system default values, use command LITINFO at the LIT level of the MAP terminal.</p>
	DCVLIMIT	1 to 300	DC voltage limit. If the entry in field DCDFT is N, enter the DC voltage threshold value (units in volts).

ALTSCHED (continued)

Field descriptions for conditional datafil (Sheet 2 of 6)

Field	Subfield or refinement	Entry	Explanation and action
	ACVOLTLIMIT	see subfield	AC voltage . This field consists of subfield ACDFT and refinement ACVLIMIT.
	ACDFT	Y or N	<p>AC voltage default. If the entry in field TSTEMF is Y, and if a system default value for the LIT EMF AC V display at the LIT level of a MAP terminal is used, enter Y. Go to field RESTG.</p> <p>If the entry in field TSTEMF is Y, and if the operating company personnel supply a value used for the LIT EMF AC V display at the LIT level of a MAP terminal, enter N and datafill refinement ACVLIMIT.</p> <p>The default value is N.</p> <p>Note: To display the system default values, use command LITINFO at the LIT level of the MAP terminal.</p>
	ACVLIMIT	1 to 300	AC voltage limit. If the entry in ACDFT is N, enter the AC voltage threshold value (units in volts).
	RESTG	see subfield	Resistance between tip and ground. This field consists of subfield TSTRESTG and refinement TGDFT.
	TSTRESTG	Y or N	<p>Test resistance between tip and ground. Enter Y if the resistance between tip and ground is tested and datafill refinement TGDFT. If the refinement is not datafilled, the default value for refinement TGDFT is used.</p> <p>Otherwise, enter N. Go to field RESRG.</p> <p>The default value is Y.</p>

ALTSCHED (continued)**Field descriptions for conditional datafil (Sheet 3 of 6)**

Field	Subfield or refinement	Entry	Explanation and action
	TGDFT	Y or N	<p>Resistance between tip and ground default. If the entry in field TSTRESTG is Y and the system default value for the LIT TG display at the LIT level of the MAP terminal is used, enter Y. Go to field RESRG.</p> <p>If the entry in field TSTRESTG is Y and the operating company personnel supply a value used for the LIT TG display at the LIT level of the MAP terminal, enter N and datafill refinements RESBDTG0 and RESBDTG1.</p> <p>The default value is N.</p> <p>Note: To display the system default values, use command LITINFO at the LIT level of the MAP terminal.</p>
	RESBDTG0	1 to 9990	Most critical resistance band between tip and ground. If the entry in field TGDFT is N, enter the most critical threshold failure resistance band between tip and ground (units of 100 Ω).
	RESBDTG1	1 to 9990	Least critical resistance band between tip and ground. If the entry in field TGDFT is N, enter the least critical threshold failure resistance band between tip and ground (units of 100 Ω).
	RESRG	see subfield	Resistance between ring and ground. This field consists of subfield TSTRESRG and refinements.
	TSTRESRG	Y or N	<p>Test resistance between ring and ground. Enter Y if the resistance between ring and ground is tested and datafill refinement RGDFT. If the refinement is not datafilled, the default value for refinement RGDFT is used.</p> <p>Otherwise, enter N. Go to field RESTR.</p> <p>The default value is Y.</p>

ALTSCHED (continued)

Field descriptions for conditional datafil (Sheet 4 of 6)

Field	Subfield or refinement	Entry	Explanation and action
	RGDFT	Y or N	<p>Resistance between ring and ground default. If the entry in field TSTRESRG is Y and the system default value for the LIT RG display at the LIT level of the MAP terminal is used, enter Y. Go to field RESTR.</p> <p>If the entry in field TSTRESRG is Y and the operating company personnel supply a value used for the LIT RG display at the LIT level of the MAP terminal, enter N and datafill refinements RESBDRG0 and RESBDRG1.</p> <p>The default value is N.</p> <p>Note: To display the system default values, use command LITINFO at the LIT level of the MAP terminal.</p>
	RESBDRG0	1 to 9990	<p>Most critical threshold failure resistance band between ring and ground. If the entry in field RGDFT is N, enter the most critical threshold failure resistance band between ring and ground (units of 100 Ω).</p>
	RESBDRG1	1 to 9900	<p>Least critical threshold failure resistance band between ring and ground. If the entry in field RGDFT is N, enter the least critical threshold failure resistance band between ring and ground (units of 100 Ω).</p>
	RESTR	see subfield	<p>Resistance between tip and ring. This field consists of subfield TSTRESTR and refinement TRDFT.</p>
	TSTRESTR	Y or N	<p>Test resistance between tip and ring. Enter Y if the resistance between tip and ring is tested and datafill refinement TRDFT. If the refinement is not datafilled, the default value for refinement TRDFT is used.</p> <p>Otherwise, enter N. Go to field CAP.</p> <p>The default value is Y.</p>

ALTSCHED (continued)

Field descriptions for conditional datafil (Sheet 5 of 6)

Field	Subfield or refinement	Entry	Explanation and action
	TRDFT	Y or N	<p>Resistance between tip and ring default. If the entry in field TSTRESTR is Y, and if a system default value for the LIT TR display at the LIT level of the MAP terminal is used, enter Y. Go to field CAP.</p> <p>If the entry in field TSTRESTR is Y, and if the operating company personnel supply a value used for the LIT TR display at the LIT level of the MAP terminal, enter N and datafill refinements RESBDTR0 and RESBDTR1.</p> <p>The default value is N.</p> <p>Note: To display the system default values, use command LITINFO at the LIT level of the MAP terminal.</p>
	RESBDTR0	1 to 9990	<p><i>Most</i> critical threshold failure resistance band between tip and ring. If the entry in field TRDFT is N, enter the most critical threshold failure resistance band between tip and ring (units of 100 Ω).</p>
	RESBDTR1	1 to 9990	<p><i>Least</i> critical threshold failure resistance band between tip and ring. If the entry in field TRDFT is N, enter the least critical threshold failure resistance band between tip and ring (units of 100 Ω).</p>
	CAP	see subfield	<p>Capacitance. This field consists of subfield TSTCAP and refinement TSTCAP.</p>
	TSTCAP	Y or N	<p>Test capacitance between tip and ring. Enter Y if the capacitance between tip and ring is tested and datafill refinement CAPDFT. If the refinement is not datafilled, the default value for refinement CAPDFT is used.</p> <p>Otherwise, enter N. Go to field STARTLEN in section All values of field TEST..</p> <p>The default value is N.</p>

ALTSCHED (continued)

Field descriptions for conditional datafil (Sheet 6 of 6)

Field	Subfield or refinement	Entry	Explanation and action
	CAPDFT	Y or N	Capacitance between tip and ring default. If the entry in field TSTCAP is Y, and if a system default value for the LIT CAP display at the LIT level of the MAP terminal is used, enter Y. If the entry in field TSTCAP is Y, and if the operating company personnel supply a value used for the LIT CAP display at the LIT level of the MAP terminal, enter N and datafill refinement CAPLIMIT. The default value is N. Note: To display the system default values, use command LITINFO at the LIT level of the MAP terminal.
	CAPLIMIT	1 to 5000	Capacitance threshold value. If the entry in field CAPDFT is N, enter the capacitance threshold value (units of 0.001 MF).

ALTSCHED (continued)**All values of field TEST**

For all values of field TEST, datafill subfields STARTLEN and ENDLEN as described below.

Field descriptions for conditional datafill

Field	Subfield or refinement	Entry	Explanation and action
	STARTLEN	see subfields	Starting line equipment number. This field, which defines the physical location of the equipment connected to a specific telephone line, specifies the start of the range of line equipment numbers that require testing.
	STARTLEN (continued)		<p>Because field LEN is common to more than 60 tables, it is documented in a single section to avoid unnecessary duplication. Refer to section "Common entry field LEN" for a complete description of field STARTLEN (described under the field name LEN) and associated subfields.</p> <p>Field STARTLEN consists of subfields SITE, FRAME, UNIT, DRAWER or LSG, SHELF, SLOT, and CIRCUIT.</p>
	ENDLEN	see subfields	<p>Ending line equipment number. This field, which defines the physical location of the equipment connected to a specific telephone line, specifies the end of the range of line equipment numbers that require testing.</p> <p>Because field LEN is common to more than 60 tables, it is documented in a single section to avoid unnecessary duplication. Refer to section "Common entry field LEN" for a complete description of field ENDLEN (described under the field name LEN) and associated subfields.</p> <p>Field ENDLEN consists of subfields SITE, FRAME, UNIT, DRAWER or LSG, SHELF, SLOT, and CIRCUIT.</p>

ALTSCHED (continued)**All values of field EXTTST**

For all values of field EXTTST, except where TEST=BBT, datafill the following additional subfields.

Field descriptions for conditional datafill (Sheet 1 of 2)

Field	Subfield or refinement	Entry	Explanation and action
SCHDTIME		vector of up to 7 subfield pairs (see subfields)	Schedule times. This field consists of subfields STARTIME and STOPTIME and is used to define the start and stop times of the tests scheduled. Up to seven start and stop times can be specified. If less than seven start and stop times are required, end the list with a \$ (dollar sign).
	STARTIME	see subfields	Start time of test. This field consists of subfields DAY, HOUR, and MINUTE.
	DAY	MON, TUE, WED, THU, FRI, SAT, or SUN	Day to start test. Enter the day of the week when the test starts.
	HOUR	00 to 23	Hour to start test. Enter the hour of the day when the test starts.
	MINUTE	00 to 59	Minute to start test. Enter the minute of the hour when the test starts.
	STOPTIME	see subfields	Stop time of test. This field consists of subfields DAY, HOUR, and MINUTE.
	DAY	MON, TUE, WED, THU, FRI, SAT, or SUN	Day to stop test. Enter the day of the week when the test stops.
	HOUR	00 to 23	Hour to stop test. Enter the hour of the day when the test stops.
	MINUTE	00 to 59	Minute to stop test. Enter the minute of the hour when the test stops.

ALTSCHED (continued)**Field descriptions for conditional datafill (Sheet 2 of 2)**

Field	Subfield or refinement	Entry	Explanation and action
	USERID	alphanumeric (1 to 16 characters)	User identification. Enter the user identification (userID) of the person who defined or last modified the table. Table control stores the correct userID. Dump and restore is "as is", the user that last updated a tuple on the ACTIVE side of the switch remains in this field, not the user on the INACTIVE side. The default value is X.
	STARTED	Y or N	Start test. Enter Y to allow the scheduler to start the test at the next time slot. Enter N to prevent the scheduler from starting the test.
	LOGFORM	FULL or SUMMARY	Log format. The entry in this field indicates which type of ALT logs to print at the completion of testing. Enter FULL for the long format of the logs. Enter SUMMARY for the short format of the logs.

Datafill example

Examples of datafill for table ALTSCHED are shown on the following pages.

The first example shows the addition of a primary tuple. The second example shows the addition of an extension tuple. The third example shows the BBT option for TEST.

In the examples, the userID logged on entering the ALT test is LNMTCJOHN. The test is for non-ISDN lines.

In the first example, the primary test DIAGTST1 runs an ALT DIAG test on STANDARD (non-ISDN) lines HOST 00 0 00 00 to REM2 00 1 18 19 starting on Mondays at 20:00, stopping on Tuesdays at 04:00 and restarting on Tuesdays at 20:00, stopping on Wednesdays at 04:00.

In the second example, the extension test DIAGTSTE runs an ALT DIAG test on STANDARD (non-ISDN) lines HOST 00 0 00 00 to REM2 00 1 18 19 specified in the primary test, starting on Mondays at 12:00, stopping on Mondays at 13:00, and restarting on Wednesdays at 20:00, stopping on Thursdays at 04:00.

ALTSCHED (continued)

It is up to the user to ensure the primary test times and the extension test times do not overlap. If there is a time overlap, one test is in a *WAIT* state, waiting for test equipment being used by the other test.

When the entries in field *SCHDTIME* are converted to the internal format, these entries are also reordered according to the day of the week. Entries with subfield *STARTIME* on *MON* appear first. Entries with subfield *STARTIME* on *SUN* appear last.

If a test is read back from table *ALTSCHED*, the entries in field *SCHDTIME* appear in the order they are recorded in the internal table, rather than the order in which they were entered.

In the first example, the times for *TUE* were entered first, and then the times for *MON*.

The addition of a primary tuple is shown below.

MAP display example of a primary tuple for table ALTSCHED

ALTTSTID	USERID		STARTED	TESTDEF		SCHDTIME		LOGFORM	
DIAGTST1	N	DIAG	STANDARD	HOST	00 0 00 00	REM2	00 1 18 19		
			(MON 20 0 TUE 4 0)			(TUE 20 0 WED 4 0)			\$
		LNMT	CJOHN		N		FULL		

The addition of an extension tuple is shown below.

MAP display example of an extension tuple for table ALTSCHED

ALTTSTID	USERI	STARTED	SCHDTIME		TESTDEF		LOGFORM	
DIAGTSTE		Y	DIAGTST1					
		(MON 12 0	MON 13 0)		(WED 20 0	THU 4 0)		\$
	LNMT	CJOHN	N	FULL				

The following example shows sample datafill when *TEST* = *BBT*.

ALTSCHED (end)**MAP display example with BBT TEST option for table ALTSCHED**

ALTTSTID		TESTDEF							
USERID		STARTED		LOGFORM					
KNTST	N	BBT	START	BY_DN	6213000	6213002	6215000	2	
1994	9	9	9	9					
	C	MAP17	N	FULL					

Table history**NA002**

The following changes were made to table ALTSCHED:

- Entry BBT was added under subfield TEST of refinement PRIMDEF of EXTTST = N.
- Conditional datafill TEST = BBT was added in table format.
- A new MAP display for datafilling table ALTSCHED with TEST = BBT was added.
- A brief functional description was added at the beginning of this module.

AMAGRPID

Table name

Automatic Message Accounting Group Identification Table

Functional description

Table AMAGRPID is used to create automatic message accounting (AMA) group identifiers. Once a group name is datafilled in table AMAGRPID, it can then be used in field OPTIONS of table LINEATTR and field GRPID in table FLEXAMA. The group name is defined by the operating company. In addition, a default AMA characteristic can be defined against the AMA group identity.

Datafill sequence and implications

There is no requirement to datafill other tables prior to table AMAGRPID.

The following tables must be datafilled after table AMAGRPID.

- LINEATTR
- FLEXAMA

Table size

0 to 63 tuples

Datafill

The following table lists datafill for table AMAGRPID.

Field descriptions (Sheet 1 of 2)

Field	Subfield or refinement	Entry	Explanation and action
GRPIDKEY		alphanumeric (up to 8 characters)	<i>Group identification</i> Enter the automatic message accounting (AMA) group identification name. This is the key field to the table.
DEFAULT		see subfield	<i>AMA group ID default</i> This field consists of subfield DFLTSEL and refinement OPT.

AMAGRPID (end)

Field descriptions (Sheet 2 of 2)

Field	Subfield or refinement	Entry	Explanation and action
	DFLTSEL	DFLTorNODFLT	<i>Default selector</i> Enter DFLT to assign a default AMA characteristic against the AMA group identity and datafill refinement OPT as explained below. Otherwise, enter no default (NODFLT) and leave all refinements blank.
	OPT	vector of up to 8 values	<i>Option</i> This refinement is a vector of up to eight values, each consisting of subfields GRPOPTN and OCI.
	GRPOPTN	FLEXOCI	<i>Group option</i> Enter the flexible originating charge information (FLEXOCI).
	OCI	1 to 255	<i>Originating charge information number</i> Enter the originating charge information (OCI) number.

Datafill example

The following example shows sample datafill for table AMAGRPID.

MAP display example for table AMAGRPID

GRPIDKEY	DEFAULT		OCI	
FR_GRP	NODFLT			
MR_GRP	DFLT	FLEXOCI	100	\$

AMAOPTS

ATTENTION

This table applies to new or modified content for SN09 (DMS) that is valid through the current release.

Automatic Message Accounting Options

Table AMAOPTS is used to control the activation and scheduling of the recording options for automatic message accounting (AMA). Table AMAOPTS contains one tuple for every option, and initially contains the default values for each of these options. The default values of these options are dependent on the entry in field FORMAT in table CRSFMT where entry in field KEY is AMA. The entry in field FORMAT can be BCFMT (Bellcore format) for Bellcore offices, NTFMT (Nortel Networks format), or another format type for non-Bellcore offices. Some of the options replace office parameters that were used in earlier software releases.

These options cannot be deleted. Adds are performed to force a display of the contents of the table and to make the tuple known to the table editor to allow for changes to the tuple. By changing the scheduling information for the options, the operating company can activate, deactivate, and schedule the options at specified dates and times, and so control the output produced by the AMA system.

The initial contents of table AMAOPTS are defined at initial program load (IPL) time, but are not displayed in the table until the tuples have been added. To add entries without affecting the default scheduling values, use the selector DEFAULT in field AMASEL, and table control replaces the selector DEFAULT with the default value.

For example, to add the default entry DA411 to table AMAOPTS in field AMAOPT, enter the tuple DA411_DEFAULT. The entry DA411 OFF is displayed, indicating that the option is disabled as a default.

If the options that control unanswered call recording (UNANS_TOLL, UNANS_LOCAL, and UNANS_TOPS) are set to Y (yes), table BCCODES (formerly ATTCODES) must also be datafilled to route unanswered calls that are not equal access calls to the call recording. Call records are produced for all equal access calls, both answered and unanswered, regardless of the datafill in these tables. See table BCCODES for further explanation.

See the first table below for a description of available options. See the second and third tables below for the default schedule values for each option, and see the fifth table for the allowable values of field AMASEL for each option.

Description of available options

Option	Explanation
ACBAR_MOD_CO	<p>This option provides a method of identifying any billable calls that are set up with Automatic Call Back (ACB) or Automatic Recall (AR) features, and includes a way of distinguishing calls to private numbers using ACB or AR. The setting of option ACBAR_MOD_CO determines whether features ACB and AR and the privacy status of a call are provided. The option ACBAR_MOD_CO is an ON or OFF parameter. If ACBAR_MOD_CO is set ON, features ACB and AR and the privacy status of a call are found in the appended module code 068. The information added to the billing record is interpreted by the downstream billing center. If it is a private number, the directory number (DN) is not printed on the subscriber's invoice. If option ACBAR_MOD_CO is set OFF, module code 068 is not appended; therefore, features ACB and AR and the privacy status information of a call are not provided. If option ACBAR_MOD_CO is set OFF, the DN of any private number is printed on the subscriber's invoice. The default value is OFF. Values other than ON, OFF, or DEFAULT are not valid.</p>
ACBAR_STY_IN	<p>This option provides a method of identifying any billable calls that are set up with ACB or AR features, and includes a way of distinguishing calls to private numbers using ACB or AR. The setting of option ACBAR_STY_IN determines whether features ACB and AR and the privacy status of a call are provided. The option ACBAR_STY_IN is an ON or OFF parameter. If option ACBAR_STY_IN is set ON, features ACB and AR and the privacy status of a call are found in character 5 of the study indicator. The information added to the billing record is interpreted by the downstream billing center. If it is a private number, the DN is not printed on the subscriber's invoice. If option ACBAR_STY_IN is set OFF, features ACB and AR and the privacy status of a call are not found in character 5 of the study indicator. If option ACBAR_STY_IN is set OFF, the DN of any private number is printed on the subscriber's invoice. The default value is OFF. Values other than ON, OFF, or DEFAULT are not valid.</p>
<p>Note: Originating equal access calls, both answered and unanswered, generate AMA records regardless of the datafill in tables AMAOPTS and BCCODES. For offices that require billing for all E800 calls, ensure that call codes 141 and 142 are datafilled against UNANS_TOLL.</p>	

Description of available options

Option	Explanation
AMATRKTG_ANS	This option controls the generation of the AMA record triggered by the option AMATTRKTG in table AMATKOPT for all calls or for answered calls only. If this option is on, the AMA records are generated only for answered calls.
APPEND_ISDN_CKT_ID	This option controls the production of the ISDN channel identifier (module 180) and trunk identification (module 181) module codes. This option gives office-wide control of these module codes. The module codes are produced for originating and terminating BRI and PRI ISDN calls. To turn on the recording of modules 180 and 181, set APPEND_ISDN_CKT_ID to ON. To stop the recording of modules 180 and 181, set APPEND_ISDN_CKT_ID to OFF. The default value for this option is OFF.
APPEND_PRI_MODULE	This option controls the addition of AMA module 070/071 to billing records for PRI originating calls. This option can be set to ON or OFF. The default value is OFF. To turn on the recording of module 070 or 071, set APPEND_PRI_MODULE to ON. To turn off the recording of module 070 or 071, set APPEND_PRI_MODULE to OFF.
AUDIT	This option controls the resetting of the internal AMA counts for the operational measurements (OM) tracer record and sets up the accumulated time change for the new day. This option cannot be changed, and appears for information only.
BACK_CHARGE	This option controls the addition of module 611 for backwards charging information on French Telephony User Part (FTUP). This activity sends charging information during the call to the (calling subscriber's) switch that performs the billing. This option allows the service provider to control the billing of the call.
<p>Note: Originating equal access calls, both answered and unanswered, generate AMA records regardless of the datafill in tables AMAOPTS and BCCODES. For offices that require billing for all E800 calls, ensure that call codes 141 and 142 are datafilled against UNANS_TOLL.</p>	

Description of available options

Option	Explanation
BCLID_USPAUD	<p>This option controls the generation of AMA records by the Bulk Calling Line Identification usage-sensitive pricing audit (BCLID_USPAUD) that is scheduled in table AMAOPTS. Option SUSP (subscriber usage-sensitive pricing) must be turned on to obtain BCLID_USP records. If a DN used as a BCLID group billing DN is also used as a Custom Local Area Signaling Services (CLASS) line with at least one CLASS display feature, then two AMA records are generated for the DN.</p> <p>Field USP in table BCLIDGRP controls the collection of AMA information for each group of BCLID subscribers. If field USP is datafilled Y (yes), AMA counts are collected for the group. The peg counts store the number of full calling DNs delivered and the combined number of PRIVATE and OUT-OF-AREA indications delivered. An AMA record is generated for each BCLID group that is datafilled for usage-sensitive pricing (USP).</p> <p>BCLID groups that are datafilled with N (no) in field USP in table BCLIDGRP are not billed on a usage-sensitive basis. No AMA records are generated for these BCLID groups.</p>
BCLONGCALL	<p>This option allows setting of the record generation time for long-duration Bellcore format records.</p>
CALL_FWD	<p>This option controls the usage recording of Call Forwarding (CFW/CFX).</p>
CALL_TIMECHG	<p>This option governs the triggering of the new time-change module on the AMA record. There are three possible values:</p> <ul style="list-style-type: none"> • ON: Enables this functionality if a time change (CI commands SETTIME or SETDATE) occurs during a call, the time-change module is appended to the resultant AMA record. • OFF: disables this functionality. This is the initial value. • DEFAULT: equates to OFF in all cases. When datafilling this tuple, option UNIVERSAL_AMA_BILLING in table OFCENG must be set to Y and option TIMECHANGE in table AMAOPTS must be set to OFF.
<p>Note: Originating equal access calls, both answered and unanswered, generate AMA records regardless of the datafill in tables AMAOPTS and BCCODES. For offices that require billing for all E800 calls, ensure that call codes 141 and 142 are datafilled against UNANS_TOLL.</p>	

Description of available options

Option	Explanation
CAPTURE_ CKTSZ_UNANS	<p>This option controls the generation of MCI 098 for unanswered calls. When set to ON, the terminating circuit seizure date and time will be captured in MCI 098.</p>
CAPTURE_ CLASS_SERV	<p>This option controls the capture of the Class of Service (COS) Index. When set to ON, the most recent Class of Service Index assigned to the originating trunk group will be captured in BCD char 6-9 of MCI 611. The MCI 611 together with the new Context ID (80058) will be attached to the AMA record. If table control is set to OFF a dummy value of Hex F will be captured in BCD char 6-9.</p> <p>By default the COS captured in MCI 611 will be the one entered in the table TRKOPTS. If the COS is overridden during the translations then the COS captured in the MCI 611 will be the COS entered in the table CLISRVPF. The COS value assigned to the call can range from 0 - 1023.</p> <p>If all the three table controls (CAPTURE_CLASS_SERV, CAPTURE_COMPL_CODE and CAPTURE_SAT_IND) are set to OFF then the MCI 611 with the new context ID (80058) will not be attached to the AMA record.</p>
<p>Note: Originating equal access calls, both answered and unanswered, generate AMA records regardless of the datafill in tables AMAOPTS and BCCODES. For offices that require billing for all E800 calls, ensure that call codes 141 and 142 are datafilled against UNANS_TOLL.</p>	

Description of available options

Option	Explanation
CAPTURE_COMPL_CODE	<p>This option controls the capture of the Completion code, representing the reason for the call termination. The completion code will be captured for either the: release cause, treatment or called/calling party disconnect.</p> <p>If the Release Cause is available, then the completion code corresponding to the Release Cause will be captured. If the Release Cause is not available, then the Treatment Code, if available, will be captured as the Completion Code. If neither are available, the Calling Party/Called Party disconnect information will be captured as the Completion Code.</p> <p>Completion Code Information is captured for the following protocols:</p> <ul style="list-style-type: none"> • ETSI ISUP V1 • ETSI ISUP V2 • IBN7 • FST R1 • FST R2 • RBTUP • BTUP • DPNSS <p>When set to ON, the reason for the call termination will be added to MCI 611 (BCD char 2-4) with the new Context ID (80058), and will be attached to the AMA record. The BCD char 1 will indicate the event in the call for which the completion code is captured. If table control is set to OFF a dummy value of Hex F will be captured in BCD char 1-4.</p> <p>If all the three table controls (CAPTURE_CLASS_SERV, CAPTURE_COMPL_CODE and CAPTURE_SAT_IND) are set to OFF then the MCI 611 with the new context ID (80058) will not be attached to the AMA record.</p>
<p>Note: Originating equal access calls, both answered and unanswered, generate AMA records regardless of the datafill in tables AMAOPTS and BCCODES. For offices that require billing for all E800 calls, ensure that call codes 141 and 142 are datafilled against UNANS_TOLL.</p>	

Description of available options

Option	Explanation
CAPTURE_ INAP_CPC	This option controls the capture of INAP CPC. If the option is turned ON and if the call involves INAP, the INAP CPC, if it exists, is captured in the AMA module code 611 (Context ID: 80027).
CAPTURE_ SAT_IND	<p>This option controls the capture of Satellite Indicator information. If the call involved a satellite circuit then this one bit flag is set to 1 (ON). Information in this field is based on the SAT field value that is datafilled against the originating trunk in table TRKSGRP. For ISUP (ETSI ISUP V1, ETSI ISUP V2, IBN7) and RBTUP protocols this information is based on the satellite information carried by the incoming IAM and the SAT field value that is datafilled against the originating trunk in the table TRKSGRP. The satellite circuit information is captured in the BCD char 5 of the MCI 611. MCI 611 with the new Context ID (80058) will be attached to the AMA record. If table control is set to '0' (OFF) a dummy value of Hex F will be captured.</p> <p>If all the three table controls (CAPTURE_CLASS_SERV, CAPTURE_COMPL_CODE and CAPTURE_SAT_IND) are set to OFF then the MCI 611 with the new context ID (80058) will not be attached to the AMA record.</p>
<p>Note: Originating equal access calls, both answered and unanswered, generate AMA records regardless of the datafill in tables AMAOPTS and BCCODES. For offices that require billing for all E800 calls, ensure that call codes 141 and 142 are datafilled against UNANS_TOLL.</p>	

Description of available options

Option	Explanation
CCBS_BILLING	<p>This option controls CCBS (Call Completion to Busy Subscriber) billing, adding usage billing for CCBS calls. It is possible to mark the billing record to indicate CCBS usage thereby providing the ability to charge for the successful usage of CCBS. The option can be set to either ON or OFF.</p> <p>If the option is set to ON, it indicates that CCBS usage billing indication will be provided in AMA records for CCBS originated calls. If the option is set to OFF, no CCBS usage billing will be provided.</p> <p>Indication of CCBS usage is provided for the following scenarios where CCBS has been initiated and the called party has become free:</p> <ul style="list-style-type: none"> • Originator ignores the ring back. • Originator answers the ring back call and disconnects immediately (before or after the called party has rung). • Ringing is applied to the called party and he doesn't answer. • A complete call setup occurs between the originator and the called party. In this scenario if an answer message is received with no charge indication then the record will be marked as unanswered with CCBS usage marked. <p>Note: This option applies to both IBN and EBS lines.</p> <p>The Service Feature field (Field 012) is used to indicate that CCBS usage has been successful. CCBS usage is marked with a service feature code of '029' in the billing record.</p> <p>Note: The service feature code value of '029' is also used to indicate BTUP CBWF usage.</p>
CCSADATA	<p>This option controls the precedence of Call Code 021 over Call Code 072 for Common Control Switching Arrangement (CCSA) data calls. It has no effect on non-data calls.</p> <p>A Call Code 072 record is produced for a CCSA data call if the CCSADATA option is set to the default value OFF.</p> <p>A Call Code 072 record is replaced by Call Code 021 if the call is a CCSA data call and the CCSADATA option is set to ON.</p>
<p>Note: Originating equal access calls, both answered and unanswered, generate AMA records regardless of the datafill in tables AMAOPTS and BCCODES. For offices that require billing for all E800 calls, ensure that call codes 141 and 142 are datafilled against UNANS_TOLL.</p>	

Description of available options

Option	Explanation
CDAR	This option controls the recording of customer-dialed account codes.
CDAR_EXTENDED	This option controls the generation of the AMA module code 850 for the capture of account codes.
CDRDUMP	This option controls the generation of an audit that provides a billing record for all calls in progress on the DMS-100E at a specified time. The default value for this option is OFF, which requires that the audit be explicitly set. Once the specified time for the audit run is reached, a copy of the call detail recording (CDR) for all calls in progress at that time is generated and sent to the respective AMA process.
CDRLONGCALL	This option controls the scheduling of a new audit to produce long-duration call CDRs (46-byte CDR format only). The first check occurs at the time specified by field START, followed by periodic checks with a period specified by field PERIOD. The option cannot be set with a period less than eight hours. ON enables the functionality. OFF disables the functionality. DEFAULT is PERIODIC with a period of eight hours, starting at the next occurrence of either 05:15, 13:15, or 21:15.
CDRSYNC	This option allows synchronization records (code 1B) to be added to the CDR data stream at intervals specified by the user. The option can be datafilled as OFF or PERIODIC. The CDR stream must be datafilled in field KEY of table CRSFMT before setting option CDRSYNC to PERIODIC. The default for this option is OFF and the format is CDR300FMT.
CHG411	This option controls charging for 411 directory assistance (DA) calls. Option DA411 must be set ON along with option CHG411 before local DA calls are written as charged. Local DA records are written as study records if option DA411 is set ON and option CHG411 is OFF.
CHG555	This option controls charging for seven-digit (555-1212) DA calls. Option DA555 must be set ON along with option CHG555 before 555 DA calls are written as charged. DA calls are written as study records if option DA555 is set ON and option CHG555 is OFF.
<p>Note: Originating equal access calls, both answered and unanswered, generate AMA records regardless of the datafill in tables AMAOPTS and BCCODES. For offices that require billing for all E800 calls, ensure that call codes 141 and 142 are datafilled against UNANS_TOLL.</p>	

Description of available options

Option	Explanation
CIDSUSPAUD	<p>This option controls the calling information delivery (CID) subscription usage-sensitive pricing (SUSP) audit that generates a billing record (for each Calling Number Delivery (CND), Dialable Number Delivery (DDN) and/or Calling Name Delivery (CNAMD) feature subscriber) that contains peg counts for each of the CLASS SUSP display options.</p> <p>If option SUSP in table AMAOPTS is ON or has been ON at any point during the audit period, then at the datafilled start time and interval, the audit produces a record for each subscription CNAMD or CND/DDN subscriber. A subscription option is one that has its billing option field set to AMA.</p> <p>If option SUSP in table AMAOPTS is OFF and has not been ON during the audit period, then the audit is not run and no records are produced.</p> <p>If a subscriber has not received any calls that increment the delivery counts for a CLASS SUSP display, then a record that contains 0 (zero) in the available and unavailable count fields for that option is produced if</p> <ul style="list-style-type: none"> • the CLASS SUSP display option is currently active • the CID options are enabled in table RESOFC • option SUSP was ON in table AMAOPTS during the last audit period <p>After the audit is complete, the AMA registers that are associated with each subscriber are set to 0 (zero) in preparation for the next audit period.</p> <p>Since this audit can produce many AMA records, we recommend that the operating company schedule the audit during low traffic hours and on a 24-h basis.</p> <p>The audit is not the only source of billing records. If a CLASS SUSP display option is changed to flat-rate or removed from the line, the delivery counts stored for the CLASS SUSP display option are reported in an AMA record appropriately.</p>
<p>Note: Originating equal access calls, both answered and unanswered, generate AMA records regardless of the datafill in tables AMAOPTS and BCCODES. For offices that require billing for all E800 calls, ensure that call codes 141 and 142 are datafilled against UNANS_TOLL.</p>	

Description of available options

Option	Explanation
	Value DEFAULT in NTFMT (Northern Telecom format) AMA switching units is OFF and cannot be changed. Value DEFAULT in BCFMT (Bellcore format) AMA switching units is PERIODIC and set to run once a day at midnight. Although option CIDSUSPAUD in table AMAOPTS cannot be turned off in a BCFMT switching unit, the audit does not run if option SUSP has been turned off since the last time the audit ran.
CITYWIDE	This option allows generation of billing records for intra-citywide virtual private network (VPN) calls that are normally non-billable. Value ON turns billing on. The default value is OFF. Values other than ON, OFF, or DEFAULT are not valid.
CLI_DELV	This option controls the capture of the CLI delivery indicator. If the option is turned ON, the CLI delivery indicator is captured in the AMA module code 611 (Context ID: 80058).
CMCICWK	For a terminating central message control (CMC) call, the carrier connect time is the time the incoming CMC trunk is seized. If option CMCICWK is set to ON, the carrier connect time on a CMC to feature group D (FGD) carrier call is the time of billing wink from the FGD carrier. A CMC access record is not created unless a billing wink is received from the FGD carrier.
CMCORIG	This option controls the generation of originating CMC billing records (call codes 63 and 64). If this option is set OFF, no call code 63 or 64 records are created.
CMCTERM	This option controls the generation of terminating CMC billing records (call codes 65 and 66). If this option is set to OFF, no call code 65 or 66 records are made.
COIN	This option controls the recording of all local coin calls.
COLL_SVC_BILL_I NFO	This option controls the use of Japan billing enhancements. These enhancements have an effect on module codes 611 and 612. To enable Japan billing enhancements, set option COLL_SVC_BILL_INFO to ON. If this option is OFF, the switch ignores AMAOPTS options RECORD DIALED_DIGS and MC611_80005.
<p>Note: Originating equal access calls, both answered and unanswered, generate AMA records regardless of the datafill in tables AMAOPTS and BCCODES. For offices that require billing for all E800 calls, ensure that call codes 141 and 142 are datafilled against UNANS_TOLL.</p>	

Description of available options

Option	Explanation
CRSEQNUM	This option controls the generation of a call record sequence number for each call record.
CRT_BILLING	This parameter controls billing records for the call redirect feature on an office-wide basis. CRT_BILLING set to ON creates a billing record for the redirected call. With CRT_BILLING set to OFF, a billing record does not generate for the redirected call.
CSMI	This option can be set to ON or OFF in order to enable or disable billing for CSMI.
DA411	This option controls the recording of calls to a local DA operator. Local DA calls are recorded as study records if option DA411 is set ON. DA calls are written as charged if options DA411 and the CHG411 are both set to ON.
DA555	This option controls the recording of seven-digit (555-1212) directory assistance calls. Ten-digit (NPA-555-1212) DA calls are always recorded as station-paid calls. DA 555 calls are recorded as study records if option DA555 is set ON. DA 555 calls are written as charged if options DA555 and CHG555 are both set ON.
DISABLE_MCD_AMA	This option activates the Minimum Call Duration parameter used on DMS switches in Israel. DISABLE_MCD_AMA supports special functionality for short calls that can be used by other customers. If the option is set ON, the Minimum Call Duration is activated. The default value is OFF.
ENABLE_SCI500	This option sets the AMA environment for DMS switches in Israel. ENABLE_SCI500 provides structure code 500 in Bellcore AMA records. If the option is set ON, the AMA environment is set up for the Israeli market. Option ENABLE_TLR_BILLING must be set ON before option ENABLE_SCI500 is activated. The default value is OFF. Any change in this option requires a reload restart.
<p>Note: Originating equal access calls, both answered and unanswered, generate AMA records regardless of the datafill in tables AMAOPTS and BCCODES. For offices that require billing for all E800 calls, ensure that call codes 141 and 142 are datafilled against UNANS_TOLL.</p>	

Description of available options

Option	Explanation
ENABLE_TLR_BILLING	This option sets the AMA environment for DMS switches in Israel. If the option is set ON, the AMA environment is set up for the Israeli market. The default value is OFF. This option controls TIV logs, generation of AMA record as a result of successful wake up request activation, generation of RBP log, implementation of OGINFO option in AMATKOPT, special Telrad implementation of CAMA, special service features in records of BOOMERANG and VML calls, sending of AMA records via MPC card, supporting of a special structure for BEARER_CAPABILITIES and SERVICE_FEATURE fields in the AMA record, implementation of FLEXCLI option in TRKOPTS table. If there is FLEXCLI option for the trunk group in TRKOPTS table, the modification of the CLI is done as written in FLEXDIGS table and the new DN is written in the record unit for AMA. Any change in this option requires a reload restart.
ENFIA_B_C	This option controls the AMA recording of ENFIA B and ENFIA C calls (for example, 950-10xx).
FREECALL	This option controls the recording of all local calls that terminate on a free number.
FTRCODE	This option indicates whether the originating and terminating feature codes in Bellcore AMA are required for international billing. Setting the tuple FTRCODE to ON results in module code 509 being appended to the 510 structure code if one of the recorded features is activated by either the calling or called party. TIMED and PERIODIC are not valid values, and are blocked when entered. The value DEFAULT sets the tuple to OFF.
GFTBILL	This option counts transport activities that have a generic function. This option appends the activities to the AMA billing record. Value ON turns billing on. The default value is OFF.
HIGHREV	This option suppresses the generation of all AMA data except for call types that are listed as high revenue in table BCCODES.
<p>Note: Originating equal access calls, both answered and unanswered, generate AMA records regardless of the datafill in tables AMAOPTS and BCCODES. For offices that require billing for all E800 calls, ensure that call codes 141 and 142 are datafilled against UNANS_TOLL.</p>	

Description of available options

Option	Explanation
IC_CDPN_INFO_REQD	This option controls the capture of Incoming Called Party Number NPI and NOA or TON information. The FLEXCPNI option (subfield IC_CDPN_INFO) in tables AMAXLAID and FLEXAMA activates this capture.
IC_CGPN_INFO_REQD	This option controls the capture of Incoming Calling Party Number (CGPN) Numbering Plan Indicator (NPI) and Nature Of Address (NOA) or Type Of Number (TON) information. The FLEXCPNI option (subfield IC_CGPN_INFO) in tables AMAXLAID and FLEXAMA activates this capture.
IC_CGPN_PI_REQD	This option provides a means to capture the incoming calling party's Presentation Indicator (PI) in AMA records and conveys the information about the Calling Line Identity (CLI) presentation or restriction.
INFO_DIGIT	This option controls whether an extra digit in the calling_dr field of the translation block in the CCB is copied into the calling_dr of the AMA PRU. When the option INFO_DIGIT is ON, the extra digit is not copied. When the option INFO_DIGIT is OFF, the extra digit is copied.
INTL_ICR_REQD	This option provides office-wide ICR activation for all IBN and BRI lines.
INTRASITE	This option allows generation of billing records for normally non-billable intra-site VPN calls. Value ON turns billing on. The default value is OFF. Values other than ON, OFF, or DEFAULT are not valid.
INWATS	This option controls the recording of all inward wide area telephone service (INWATS) calls.
ISDN_ACCIND	When set to ON, this option provides the correct ISDN access indicator value in the Module code 611 AMA billing record for the supported interworkings, providing the options COLL_SVC_BILL_INFO and MC611_80005 are also ON. When the ISDN_ACCIND option is set to OFF, the terminating ISDN indicator is recorded as 'unknown' for some of the supported interworkings in the Japan market.
<p>Note: Originating equal access calls, both answered and unanswered, generate AMA records regardless of the datafill in tables AMAOPTS and BCCODES. For offices that require billing for all E800 calls, ensure that call codes 141 and 142 are datafilled against UNANS_TOLL.</p>	

Description of available options

Option	Explanation
ISDN_ETSI_BS	When set to ON, this option specifies that all ISDN PRI and BRI calls have a module code 030 appended to their AMA billing record.
ISDNBBGBILL	<p>This option allows the production of billing records for basic business group (BBG) facilities and services on ISDN BRI lines. If ISDNBBGBILL is ON, the switch appends module code 074 to all ISDN BRI AMA records.</p> <p>Module code 074 identifies</p> <ul style="list-style-type: none"> the BBG call type the billing number of the BBG customer the associated virtual facility group (VFG) or trunk group number (TGN) used in the call <p>This option applies only to ISDN BRI lines, and it controls the production of BBG billing records office-wide.</p>
ISDNCIRCUIT	This option controls the production of the ISDN circuit structures and philosophies office-wide. The structures consist of ISDN core module 070/071 and ISDN terminating user service module 073. The philosophies consist of call types and allow the operating company to specify signaling capabilities that are considered a basis for originating or terminating detailed billing.
LNID	This option can only be OFF. This tuple is forced to OFF during a dump and restore or when operating company personnel attempt to change its value. This option controls the inclusion of a coded representation of the line ID in the AMA record. This option has no effect if entry in field FORMAT, in table CRSFMT, where field KEY = AMA, is NTFMT.
LNP_721	This option creates an LNP record for Bellcore call code 721. The option has values of ON, OFF, and DEFAULT. The default is OFF.
LNP_721_Use_SC0500	This option creates an LNP record for Bellcore call type code 721 with structure code 500. The option has values of ON, OFF, and DEFAULT. The default is OFF. With this option OFF, LNP721 records generate with structure code 0001.
<p>Note: Originating equal access calls, both answered and unanswered, generate AMA records regardless of the datafill in tables AMAOPTS and BCCODES. For offices that require billing for all E800 calls, ensure that call codes 141 and 142 are datafilled against UNANS_TOLL.</p>	

Description of available options

Option	Explanation
LNP_721_ PortedDNOnly	This option creates an LNP record for Bellcore call code 721 only when the dialed DN is ported. The option has values of ON, OFF, and DEFAULT. The default is OFF.
LNP_722	This option creates a last resort LNP record, Bellcore call code 722. Last resort AMA is generated when last resort routing to a recipient switch occurs at a donor switch and an AMA record is not already being generated at the donor switch. The option has values of ON, OFF, and DEFAULT. The default is OFF.
LNP_BILL_ DONOR	This option is used to trigger AMA billing records at the donor exchange in LNP QoR calls.
LNP_MODULE_ 719	This option controls the kind of module that LNP appends to an AMA record. The default is OFF, which means that LNP stores portability information in module 720.
LOG117_ CALLING_DN	This option controls whether the calling DN is copied into the AMAB117 log. ON copies the DN to AMAB117. OFF does not record the DN.
LOGAMA	This option controls the generation of AMAB117 log reports. If this option is set ON, AMAB117 log reports are generated for each record that is put on the AMA tape. (This is used instead of office parameter SPECIAL_AMA_REPORT in table OFCVAR.)
LOGOPT	This option controls the generation of a log outlining the status of the AMA recording options such as active or inactive.
LOGTEST	This option controls the generation of AMAB200 log reports. If it is set ON, AMAB200 log reports are generated for AMA billable calls to or from a line with the line option AMATEST enabled in table LENLINES.
LONGCALL	This option controls the production of AMA records periodically during the course of long-duration calls.
LUSORIG	This option controls the recording of all calls that originate on a line with line usage study (LUS) as defined in table LENFEAT.
<p>Note: Originating equal access calls, both answered and unanswered, generate AMA records regardless of the datafill in tables AMAOPTS and BCCODES. For offices that require billing for all E800 calls, ensure that call codes 141 and 142 are datafilled against UNANS_TOLL.</p>	

Description of available options

Option	Explanation
LUSTERM	This option controls the recording of all calls that terminate on a line with LUS as defined in table LENFEAT.
MC130_FOR_CLF	<p>This option allows module code 130 to be appended on tandem or terminating DMS-100 offices when a call is normally clear forwarded before the terminator goes off hook. The option is set to ON to activate the feature. If it is set to OFF, MC130 is appended for only rejected calls.</p> <p>When activating and deactivating this option, a caution is printed to indicate the change in functionality as shown below:</p> <ul style="list-style-type: none"> • For activation (ON state): "This change results MC130 generation for unanswered calls clear forwarded normally" • For deactivation (OFF state): "This change prevents MC130 generation for unanswered calls clear forwarded normally"
MC611_80005	This option controls the addition of module code 611 (80005) to AMA billing records for the office. To enable the recording of module code 611 (80005), set option MC611_80005 to ON. To disable the recording of module code 611 (80005), set option MC611_80005 to OFF. The default value for this option is OFF.
MWIC_AUDIT	This option provides the DMS-100 switch the ability to generate daily AMA records of aggregate counts of successful MWI control activations and deactivations on an MSRID basis. The MWIC_AUDIT option works in conjunction with the BILLNUM option of table MSRTAB. MWIC_AUDIT schedules the audit to capture the metrics of the new BILLNUM option.
NTAI	This option controls the generation of AMA Module 611 NTAI information switch-wide depending on the subfield ON/OFF setting.
OBSERVED	This option controls the recording of all calls that originate on a line with complaint observed studies (OBS) as defined in table LENFEAT.
<p>Note: Originating equal access calls, both answered and unanswered, generate AMA records regardless of the datafill in tables AMAOPTS and BCCODES. For offices that require billing for all E800 calls, ensure that call codes 141 and 142 are datafilled against UNANS_TOLL.</p>	

Description of available options

Option	Explanation
OCCOVFL	This option controls the recording of equal access overflow calls (call code 120). Option OCCOVFL is dependent on the use of fixed pseudo-code EAPEG, which must be added to table CLLI and must be datafilled in table OFRT. When EAPEG is encountered in the route list of table OFRT, an overflow count is pegged against the destination carrier in table OCCINFO.
OCCTERM	This option controls the recording of terminating equal access calls (call code 119). If option OCCTERM is ON, these records are produced. If OCCTERM is OFF, these records are not produced. Note: The only option supported by GSF031 release for equal access is OCCTERM.
OUTWATS	This option controls the recording of all OUTWATS calls.
OVERFLOW	This option controls the recording of all INWATS or LUS calls that failed to terminate for any reason.
RECORD_DIALED_DIGS	This option controls the addition of module code 040 to AMA billing records for the office. Module code 040 records the dialed digits received at call setup. To enable the recording of module code 040, set option RECORD_DIALED_DIGS to ON. To disable the recording of module code 040, set option RECORD_DIALED_DIGS to OFF. The default value for this option is OFF.
RECORD_LSPI	This option enables the generation of LSPI recording on a switch-wide basis.
Note: Originating equal access calls, both answered and unanswered, generate AMA records regardless of the datafill in tables AMAOPTS and BCCODES. For offices that require billing for all E800 calls, ensure that call codes 141 and 142 are datafilled against UNANS_TOLL.	

Description of available options

Option	Explanation
RECORD_MTZ	<p>RECORD_MTZ allows customers that have the Multiple Time Zone (MTZ) feature to record a corrected timestamp for billing records that originate on agents with the MTZ line option.</p> <p>MTZ is a feature used for countries with more than one time zone, to account for the situation that a line agent can be located in a different time zone than the call server. In this case, without the MTZ feature, the time used for applications such as billing would reflect the time zone of the call server rather than the time zone where the agent is located. The MTZ option allows operating companies to add or subtract time from the switch time - to give the correct timing for the call for billing purposes.</p> <p>The connect timestamp is modified to the agent's time zone, and this timestamp is appended to the existing billing record in AMA (using module code 611, context ID 80200) and to SMDR (using an extension record).</p>
RECORD_MC260	<p>This option activates recording of packet client involvement for both originating and terminating agents in AMA billing Module 260. This option does not force billing; it collects the additional information for existing billable scenarios. Feature A00009508 (which introduced this module) only activates the information capture for customer premises equipment that use SIP.</p>
RECORD_NATIVE_LSPI	<p>This option enables the generation of module codes 338 and 125, and LSPI call type codes 126, 127, and 128 on a switch-wide basis for native agents. Turn on the RECORD_LSPI option before using this option.</p>
RECORD_RESOLD_LSPI	<p>This option enables the generation of module codes 338 and 125, and LSPI call type codes 126, 127, and 128 on a switch-wide basis for resold agents. Turn on the RECORD_LSPI option before using this option.</p>
<p>Note: Originating equal access calls, both answered and unanswered, generate AMA records regardless of the datafill in tables AMAOPTS and BCCODES. For offices that require billing for all E800 calls, ensure that call codes 141 and 142 are datafilled against UNANS_TOLL.</p>	

Description of available options

Option	Explanation
RECORD_SIGNAL_LSPI	This option lets users add the MC338 (LSPI) module to the generated billing record on a switch-wide basis. The default value for this option is OFF, which deactivates the option. Note that users must also activate the RECORD_LSPI option in table AMAOPTS to activate the RECORD_SIGNAL_LSPI option. When both options are ON, the switch records the signaled LSPAO and LPSO information in module 338 and adds it to the billing record.
RECORD_TERMINATION	This option controls the recording of terminating information on trunk calls routed from the VPN trunk calls encountering busy or no-circuit problems.
RECORD_TRUNK_LSPI	This option controls the generation of trunk-related LSPI recording for selected inter-switch public trunk types. The default value is OFF, indicating that recording of trunk-related LSPI information is inactive on the switch. Turn on the RECORD_LSPI option before using this option.
RECORD_UNBUND_LSPI	This option enables the generation of module codes 338 and 125, and LSPI call type codes 126, 127, and 128 on a switch-wide basis for unbundled agents. Turn on the RECORD_LSPI option before using this option.
SAID_MOD_SUPPR	This option controls the production of module 047 on an office-wide basis. Module 047 is appended for Speech Activated Intelligent Dialing calls. To stop the generation of module 047, set SAID_MOD_SUPPR to ON. To enable the generation of module 047, set SAID_MOD_SUPPR to OFF.
STORE_CALLREF	This option enables the capture of Call identity and Point code in the AMA billing record. These values are obtained from the Call Reference Parameter in the IAM message. The default value is OFF, which deactivates this option. The STORE_CALLREF option works in conjunction with the TRKOPTS option CALLREF for ETSI ISUP V2 trunks.
STORE_LRN	This option is used to trigger additional AMA billing module 612 for ported-in number originated calls.
<p>Note: Originating equal access calls, both answered and unanswered, generate AMA records regardless of the datafill in tables AMAOPTS and BCCODES. For offices that require billing for all E800 calls, ensure that call codes 141 and 142 are datafilled against UNANS_TOLL.</p>	

Description of available options

Option	Explanation
SUSP	<p>This option controls SUSP.</p> <p>If option SUSP is OFF (the default)</p> <ul style="list-style-type: none"> • no SUSP billing occurs • service order prompting for SUSP is suppressed <p>If option SUSP is ON</p> <ul style="list-style-type: none"> • service order prompting for BILLING_OPTION is enabled • SUSP billing is enabled for the office (and SUSP billing takes place on lines that have the AMA BILLING_OPTION) <p>SUSP records are not recorded under any conditions if parameter AMA_FORMAT is NT.</p> <p>SUSP is also provided for the screening list editing (SLE) features: Selective Call Forwarding (SCF), Selective Call Rejection (SCRJ), Selective Call Acceptance (SCA), and Distinctive Ringing/Call Waiting (DRCW). The usage-sensitive context here means generating billing records each time the subscriber accesses an SLE USP feature screening list or activates or deactivates a SLE USP feature. Billing records are not generated each time a terminating call is screened by a subscriber's SLE USP feature.</p> <p>To enable usage-sensitive pricing (USP) for SLE features</p> <ul style="list-style-type: none"> • the feature or features must be enabled in table RESOFC • the feature or features must be assigned to a line • the SUSP entry in table AMAOPTS must be set ON • the BILLING_OPTION prompt, which is displayed when adding or changing an SLE feature, must be set to AMA
TIMECHANGE	<p>This option controls the generation of time-change records if the time or date on the switch is set by the command interpreter (CI) commands SETTIME or SETDATE at a maintenance and administration position (MAP) terminal.</p>
TRACER	<p>This option controls the production of an AMA tracer record containing peg counts of several AMA events such as originations or records output.</p>
<p>Note: Originating equal access calls, both answered and unanswered, generate AMA records regardless of the datafill in tables AMAOPTS and BCCODES. For offices that require billing for all E800 calls, ensure that call codes 141 and 142 are datafilled against UNANS_TOLL.</p>	

Description of available options

Option	Explanation
TRKID	This option can only be OFF. This tuple is forced to OFF during a dump and restore or when operating company personnel attempt to change its value. This option controls the inclusion of a coded representation of the terminating trunk ID in the AMA record. This option has no effect when parameter AMA_FORMAT is NT.
TRMTID_CAPTURE	This option controls the capture of the treatment ID applied to calls that have failed to be routed out of the DMS-100 switch. With this option ON, any billable calls that fail on 2-way or incoming ISUP, BTUP, FST R1, FST R2, RBTUP, ETSI PRI and DPNSS trunks result in the generation of an AMA module code130 with call characteristic value 10.
TWC	This option controls the usage recording of three-way calling (3WC).
U3WC	This option controls the usage recording of three-way calling - usage sensitive (U3WC).
UNANS_AIN	This option controls Advanced Intelligent Network (AIN) specific unanswered call recording. If option UNANS_AIN is turned on, an AMA record is produced for every unanswered billable AIN call whose call type is datafilled in tuple AIN in table BCCODES. If switch-based unanswered call recording is in effect for a certain call type, then unanswered AIN calls of that call type are recorded, regardless of whether or not UNANS_AIN is turned ON. The default value is OFF.
UNANS_LOCAL	This option controls the recording of unanswered local calls. Only those local calls that generate AMA records are recorded. The call is defined as toll, local, high revenue, or Traffic Operator Position System (TOPS) in table BCCODES. The unanswered calls must have the associated call code datafilled in table BCCODES. If option UNANS_LOCAL is set ON, answered and unanswered local calls are recorded. (Equal access calls are unaffected; see note.) If the unanswered call is a billable Capability Set 1 Revised (CS-1R) call, an AMA record is generated regardless of what UNANS_LOCAL is set to. A CS-1R call is billable if a furnish charging information (FCI) operation is received from the SCP for that call.
<p>Note: Originating equal access calls, both answered and unanswered, generate AMA records regardless of the datafill in tables AMAOPTS and BCCODES. For offices that require billing for all E800 calls, ensure that call codes 141 and 142 are datafilled against UNANS_TOLL.</p>	

Description of available options

Option	Explanation
UNANS_TOLL	This option controls the recording of unanswered toll calls. Only those toll calls that generate AMA records are recorded. The call is defined as toll, local, high revenue, or TOPS in table BCCODES. The unanswered calls must have the associated call code datafilled in table BCCODES. If option UNANS_TOLL is set to ON, answered and unanswered toll calls are recorded. Option UNANS_TOLL is used instead of office parameter, NO_ANS_CALLS_ONTAPE in table OFCENG. (Equal access calls are unaffected; see note.) If the unanswered call is a billable CS-1R call, an AMA record is generated regardless of what UNANS_TOLL is set to. A CS-1R call is billable if a furnish charging information (FCI) operation is received from the SCP for that call.
UNANS_TOPS	This option controls the recording of unanswered TOPS calls. Only those TOPS calls that generate AMA records are recorded. The call is defined as toll, local, high revenue, or TOPS in table BCCODES. The unanswered calls must have the associated call code datafilled in table BCCODES. If the option UNANS_TOPS is set ON, answered and unanswered TOPS calls are recorded. (Equal access calls are unaffected; see note.)
<p>Note: Originating equal access calls, both answered and unanswered, generate AMA records regardless of the datafill in tables AMAOPTS and BCCODES. For offices that require billing for all E800 calls, ensure that call codes 141 and 142 are datafilled against UNANS_TOLL.</p>	

In table CRSFMT, if the entry in field KEY is AMA, and the entry in field FORMAT is BCFMT (Bellcore format), the default values for the options in table AMAOPTS are as listed in the following table.

Default schedule values for Bellcore format options

Option	Default schedule
ACBAR_MOD_CO	OFF
ACBAR_STY_IN	OFF
AMATRKTG_ANS	OFF
<p>Note: yymmdd is the date at initial program load (IPL) time, and hh00 is the time at IPL.</p>	

Default schedule values for Bellcore format options

Option	Default schedule
APPEND_ISDN_CKT_ID	OFF
APPEND_PRI_MODULE	OFF
AUDIT	PERIODIC yymmdd 0000 24 HRS
BCLID_USPAUD	PERIODIC yymmdd 0000 24 HRS
BCLONGCALL	PERIODIC yymmdd 0000 24 HRS
CALL_FWD	ON
CALL_TIMECHG	OFF
CAPTURE_CKTSZ_UNANS	OFF
CAPTURE_CLASS_SERV	OFF
CAPTURE_COMPL_CODE	OFF
CAPTURE_INAP_CPC	OFF
CAPTURE_SAT_IND	OFF
CCBS_BILLING	OFF
CCSADATA	OFF
CDAR	OFF
CDAR_EXTENDED	OFF
CDRDUMP	OFF
CDRLONGCALL	PERIODIC
CHG411	OFF
CHG555	OFF
Note: yymmdd is the date at initial program load (IPL) time, and hh00 is the time at IPL.	

Default schedule values for Bellcore format options

Option	Default schedule
CIDSUSPAUD	PERIODIC yymmdd 0000 24 HRS
CITYWIDE	OFF
CLI_DELV	OFF
CMCICWK	OFF
CMCORIG	OFF
CMCTERM	OFF
COIN	OFF
COLL_SVC_BILL_INFO	OFF
CRSEQNUM	OFF
CRT_BILLING	OFF
CSMI	ON
DA411	OFF
DA555	OFF
DSCWID_CONF_AUDIT	OFF
ENFIA_B_C	ON
FREECALL	OFF
FTRCODE	OFF
GFTBILL	OFF
HIGHREV	OFF
INTL_ICR_REQD	OFF
INTRASITE	OFF
Note: yymmdd is the date at initial program load (IPL) time, and hh00 is the time at IPL.	

Default schedule values for Bellcore format options

Option	Default schedule
INWATS	OFF
ISDN_ACCIND	OFF
ISDNBBGBILL	OFF
ISDNCIRCUIT	OFF
LNID	OFF
LNP_BILL_DONOR	OFF
LOGAMA	OFF
LOGOPT	PERIODIC yymmdd 1200 24 HRS
LOGTEST	OFF
LONGCALL	PERIODIC yymmdd 0000 24 HRS
LUSORIG	OFF
LUSTERM	OFF
MC130_FOR_CLF	OFF
MC611_80005	OFF
MWIC_AUDIT	PERIODIC yymmdd 0000 24 HRS
NTAI	OFF
OBSERVED	OFF
OCCOVFL	PERIODIC yymmdd 2300 1 HRS
OCCTERM	ON
OUTWATS	OFF
Note: yymmdd is the date at initial program load (IPL) time, and hh00 is the time at IPL.	

Default schedule values for Bellcore format options

Option	Default schedule
OVERFLOW	PERIODIC yymmdd 2300 24 HRS
RECORD_DIALED_DIGS	OFF
RECORD_LPSI	OFF
RECORD_MC260	OFF
RECORD_MTZ	OFF
RECORD_NATIVE_LSPI	OFF
RECORD_RESOLD_LSPI	OFF
RECORD_SIGNAL_LSPI	OFF
RECORD_TERMINATION	OFF
RECORD_TRUNK_LSPI	OFF
RECORD_UNBUND_LSPI	OFF
SAID_MOD_SUPPR	OFF
STORE_CALLREF	OFF
STORE_LRN	OFF
SUSP	OFF
TIMECHANGE	OFF
TRACER	PERIODIC yymmdd hh00 1 HRS
TRKID	OFF
TWC	ON
U3WC	ON
UNANS_AIN	OFF
Note: yymmdd is the date at initial program load (IPL) time, and hh00 is the time at IPL.	

Default schedule values for Bellcore format options

Option	Default schedule
UNANS_LOCAL	OFF
UNANS_TOLL	OFF
UNANS_TOPS	OFF
Note: yymmdd is the date at initial program load (IPL) time, and hh00 is the time at IPL.	

In table CRSFMT, if the entry in field KEY is AMA, and the entry in field FORMAT is NTFMT (Nortel Networks format) or another non-Bellcore format, the default values for the options in table AMAOPTS are listed in the following table.

Default schedule values for non-Bellcore format options

Option	Default schedule
AUDIT	PERIODIC yymmdd 0000 24 HRS
CALL_FWD	OFF
CCSADATA	OFF
CDAR	OFF
CDRDUMP	OFF
CDRLONGCALL	PERIODIC
CDRSYNC	OFF
CHG411	OFF
CHG555	OFF
CIDSUSPAUD	OFF
COIN	OFF
DA411	OFF
Note: yymmdd is the date at IPL time, and hh00 is the time at IPL.	

Default schedule values for non-Bellcore format options

Option	Default schedule
DA555	OFF
ENFIA_B_C	ON
FREECALL	OFF
HIGHREV	OFF
INWATS	OFF
LNID	OFF
LOGAMA	OFF
LOGOPT	OFF
LONGCALL	PERIODIC yymmdd hhmm 1 HRS
LUSORIG	OFF
LUSTERM	OFF
OBSERVED	OFF
OCCOVFL	PERIODIC yymmdd 2300 1 HRS
OCCTERM	ON
OUTWATS	OFF
OVERFLOW	OFF
STORE_CALLREF	OFF
TIMECHANGE	OFF
TRACER	OFF
TRKID	OFF
TWC	OFF

Note: yymmdd is the date at IPL time, and hh00 is the time at IPL.

Default schedule values for non-Bellcore format options

Option	Default schedule
UNANS_LOCAL	OFF
UNANS_TOLL	OFF
UNANS_TOPS	OFF
Note: yymmdd is the date at IPL time, and hh00 is the time at IPL.	

In table CRSFMT, if the entry in field KEY is AMA, and the entry in field FORMAT is BCFMT (Bellcore format), the allowable values for field AMASEL in table AMAOPTS are as listed in the following table.

Allowable AMASEL values for each Bellcore format option

Option	ON	OF	TIME	PERIODI	DEFAU
		F	D	C	LT
ACBAR_MOD_CO	X	X			X
ACBAR_STY_IN	X	X			X
AMATRKTG_ANS	X	X			X
APPEND_ISDN_CKT_ID	X	X			X
APPEND_PRI_MODULE	X	X			X
AUDIT					X
BCLID_USPAUD	X	X	X		X
BCLONGCALL				X	X
CALL_FWD	X	X	X		X
CALL_TIMECHG	X	X			X
CAPTURE_CKTSZ_UNANS	X	X			X
CAPTURE_CLASS_SERV	X	X			X

Allowable AMASEL values for each Bellcore format option

Option	ON	OF	TIME	PERIODI	DEFAU
			D	C	LT
CAPTURE_COMPL_CODE	X	X			X
CAPTURE_INAP_CP C	X	X			X
CAPTURE_SAT_IND	X	X			X
CCBS_BILLING	X	X			X
CCSADATA	X	X			X
CDAR	X	X	X		X
CDAR_EXTENDED	X	X			X
CDRDUMP		X		X	X
CDRLONGCALL	X	X		X	X
CHG411	X	X	X		X
CHG555	X	X	X		X
CIDSUSPAUD				X	X
CITYWIDE	X	X			X
CLI_DELV	X	X			X
CMCICWK	X	X	X		X
CMCORIG	X	X	X		X
CMCTERM	X	X	X		X
COIN	X	X	X		X
COLL_SVC_BILL_INF O	X	X			X
CRSEQNUM	X	X			X
CRT_BILLING	X	X			X

Allowable AMASEL values for each Bellcore format option

Option	ON	OF	TIME	PERIODI	DEFAU
		F	D	C	LT
CSMI	X	X			X
DA411	X	X	X		X
DA555	X	X	X		X
DSCWID_CONF_AUDIT		X		X	X
ENFIA_B_C	X	X	X		X
FREECALL	X	X	X		X
FTRCODE	X	X			X
HIGHREV		X	X		X
INTL_ICR_REQD	X	X			X
INTRASITE	X	X			X
INWATS	X	X	X		X
ISDN_ACCIND	X	X			X
ISDNBBGBILL	X	X			X
ISDNCIRCUIT	X	X	X		X
LNID		X			X
LNP_BILL_DONOR	X	X			X
LOGAMA	X	X	X		X
LOGOPT		X		X	X
LOGTEST	X	X			X
LONGCALL				X	X
LUSORIG	X	X	X		X
LUSTERM	X	X	X		X

Allowable AMASEL values for each Bellcore format option

Option	ON	OF	TIME	PERIODI	DEFAU
		F	D	C	LT
MC130_FOR_CLF	X	X			
MC611_80005	X	X			X
MWIC_AUDIT		X		X	X
OBSERVED	X	X	X		X
OCCOVFL	X	X	X	X	X
OCCTERM	X	X	X		X
OUTWATS	X	X	X		X
OVERFLOW		X		X	X
RECORD_DIALED_DIGS	X	X			X
RECORD_LPSI	X	X			X
RECORD_NATIVE_LSPI	X	X			X
RECORD_RESOLD_LSPI	X	X			X
RECORD_SIGNAL_LSPI	X	X			X
RECORD_TRUNK_LSPI	X	X			X
RECORD_UNBUND_LSPI	X	X			X
SAID_MOD_SUPPR	X	X			X
STORE_CALLREF	X	X			X
STORE_LRN	X	X			X
SUSP	X	X	X		X
TIMECHANGE	X	X			X

Allowable AMASEL values for each Bellcore format option

Option	ON	OF	TIME	PERIODI	DEFAU
		F	D	C	LT
TRACER		X		X	X
TRKID		X			X
TWC	X	X	X		X
U3WC	X	X	X		X
UNANS_AIN	X	X	X		X
UNANS_LOCAL	X	X	X		X
UNANS_TOLL	X	X	X		X
UNANS_TOPS	X	X	X	X	X

In table CRSFMT, if the entry in field KEY is AMA, and in field FORMAT is NTFMT (Nortel format) or other non-Bellcore format, the allowable values for field AMASEL in table AMAOPTS are as listed in the following table.

Allowable AMASEL values for each non-Bellcore format option

Option	ON	OF	TIME	PERIODI	DEFAU
		F	D	C	LT
AUDIT					X
APPEND_ISDN_CKT_ID	X	X			X
CALL_FWD		X			X
CCSADATA	X	X			X
CDAR		X			X
CDRDUMP		X		X	X
CDRLONGCALL	X	X		X	X
CDRSYNC		X		X	X
CHG411		X			X

Allowable AMASEL values for each non-Bellcore format option

Option	ON	OF	TIME D	PERIODI C	DEFAU LT
CHG555		X			X
CIDSUSPAUD		X			X
COIN		X			X
DA411		X			X
DA555		X			X
ENFIA_B_C		X			X
FREECALL		X			X
HIGHREV		X			X
INWATS		X			X
LNID		X			X
LOGAMA		X			X
LOGOPT		X			X
LONGCALL				X	X
LUSORIG		X			X
LUSTERM		X			X
OBSERVED		X			X
OCCOVFL	X	X	X	X	X
OCCTERM	X	X	X		X
OUTWATS		X	X		X
OVERFLOW		X		X	X
SAID_MOD_SUPPR	X	X			X
STORE_CALLREF	X	X			X
TIMECHANGE		X			X

Allowable AMASEL values for each non-Bellcore format option

Option	ON	OF	TIME	PERIODI	DEFAU
		F	D	C	LT
TRACER		X			X
TRKID		X			X
TWC		X			X
UNANS_LOCAL		X			X
UNANS_TOLL		X			X
UNANS_TOPS		X			X

Datafill sequence and meaning

Table CRSFMT must be datafilled before table AMAOPTS.

Table size

Table size is determined by the number of options currently supported. This number is static.

Datafill

The following table lists datafill for table AMAOPTS.

Field descriptions

Field	Subfield	Entry	Explanation and action
OPTION		see subfield	<i>Option</i> This field consists of subfield AMAOPT.
	AMAOPT	alphanumeric	<i>AMA option</i> Enter one of the option values listed in the first table in this chapter.
SCHEDULE		see subfields	<i>Schedule</i> This field consists of subfields AMASEL, ONDATE, OFFDATE, SCHED, ONTIME, and OFFTIME.

Field descriptions

Field	Subfield	Entry	Explanation and action
	AMASEL	ON, OFF, DEFAULT, PERIODIC, TIMED	<p><i>AMA selector</i></p> <p>Enter one of the values listed in the fourth and fifth tables in this chapter.</p> <ul style="list-style-type: none"> • ON: Activate the option immediately. • OFF: Deactivate the option immediately. • DEFAULT: Use the default schedule for the option. The value DEFAULT never appears in table AMAOPTS, since table control replaces it with the actual default value; details are shown in the cross-reference tables in this chapter. The DEFAULT selector can be used at any time and the switch recalculates the default value if the default AMASEL value is PERIODIC. • PERIODIC: Activate the option at the specified date and time and perform the activity periodically at the interval specified. Datafill subfields ONDATE and ONTIME to specify the date and time for activation, and datafill SCHED for the time intervals at which to perform the activity. For PERIODIC refinements, refer to AMASEL=PERIODIC conditional datafill table. • TIMED: Activate the option between the specified dates and times. Datafill refinements ONDATE and ONTIME to activate the option, and refinements OFFDATE and OFFTIME to deactivate the option. For TIMED refinements, refer to AMASEL=TIMED conditional datafill table.

AMASEL = PERIODIC

If the entry in subfield AMASEL is PERIODIC, datafill refinements ONDATE, ONTIME, SCHED, TV, and TU as described in the following table.

Field descriptions for conditional datafill

Field	Subfield	Entry	Explanation and action
	ONDATE	0 to 9(6 digits)	<i>Activation on date</i> Enter the year, followed by the month, followed by the day (yymmdd) on which the activation of the option is set to ON. For example, 821105.
	ONTIME	0 to 9(4 digits)	<i>Activation on time</i> Enter the hour, followed by the minute (hhmm) on which the activation of the option is set to ON. For example, an ON time of 1:45 p.m. is entered as 1345.
	SCHED	see subfields	<i>Periodic schedule</i> This field consists of subfields TV and TU.
	TV	0 to 255	<i>Time value</i> Enter the time value for periodic scheduling. For example, an entry of 9, activates the option for the period of time units selected in subfield TU.
	TU	HRS, MINS, or SECS	<i>Time unit</i> Enter the time unit for the time value selected in subfield TV.
Note: Years 82 to 99 mean 1982 to 1999, while years 00 to 81 mean 2000 to 2081. Dates that are past cannot be entered in this field by the commands CHANGE or ADD.			

AMASEL = TIMED

If the entry in subfield AMASEL is TIMED, datafill refinements ONDATE, ONTIME, OFFDATE, and OFFTIME, as described in the following table.

Field descriptions for conditional datafill

Field	Subfield	Entry	Explanation and action
	ONDATE	0 to 9 (maximum 6 digits)	<i>Activation on date</i> Enter the year, followed by the month, followed by the day (yymmdd) on which the activation of the option is set to ON. For example, 821105.
	ONTIME	0 to 9 (maximum 4 digits)	<i>Activation on time</i> Enter the hour, followed by the minute (hhmm) on which the activation of the option is set to ON. For example, an ON time of 1:45 p.m. is entered as 1345.
	OFFDATE	0 to 9 (maximum 6 digits)	<i>Activation off date</i> Enter the year, followed by the month, followed by the day (yymmdd) on which the activation of the option is set to OFF. For example, 821106.
	OFFTIME	0 to 9 (maximum 4 digits)	<i>Activation off time</i> Enter the hour, followed by the minute (hhmm) on which the activation of the option is set to OFF. For example, an OFF time of 11:00 p.m., is entered as 2300.
Note: Years 82 to 99 mean 1982 to 1999, while years 00 to 81 mean 2000 to 2081. Dates that are past cannot be entered in this field by commands CHANGE or ADD.			

Datafill example

The following example shows sample datafill for table AMAOPTS.

MAP display example for option CCBS_BILLING in table AMAOPTS

OPTION	SCHEDULE
CCBS_BILLING	ON

MAP display example for table AMAOPTS

OPTION	SCHEDULE
ACBAR_MOD_CO	OFF
RECORD_SIGNAL_LSPI	OFF
INTL_ICR_REQD	ON

MAP display example for option LNP_BILL_DONOR in table AMAOPTS

OPTION	SCHEDULE
LNP_BILL_DONOR	ON

MAP display example for option RECORD_TRUNK_LSPI in table AMAOPTS

OPTION	SCHEDULE
RECORD_TRUNK_LSPI	ON

MAP display example for option NTAI in table AMAOPTS

OPTION	SCHEDULE
NTAI	OFF

MAP display example for option STORE_CALLREF in table AMAOPTS

OPTION	SCHEDULE
STORE_CALLREF	ON

MAP display example for option STORE_LRN in table AMAOPTS

OPTION	SCHEDULE
STORE_LRN	ON

MAP display example for option CAPTURE_CKTSZ_UNANS in table AMAOPTS

OPTION	SCHEDULE
CAPTURE_CKTSZ_UNANS	ON

MAP display example for option TRMTID_CAPTURE in table AMAOPTS

OPTION	SCHEDULE
TRMTID_CAPTURE	ON

MAP display example for options CAPTURE_CLASS_SERV, CAPTURE_COMPL_CODE and CAPTURE_SAT_IND in table AMAOPTS

OPTION	SCHEDULE
CAPTURE_COMPL_CODE	ON
CAPTURE_CLASS_SERV	ON
CAPTURE_SAT_IND	ON

MAP display example for option MC130_FOR_CLF in table AMAOPTS

OPTION	SCHEDULE
MC130_FOR_CLF	ON

MAP display example for option RECORD_MC260 (activation and deactivation) in table AMAOPTS

```

>table amaopts
JOURNAL FILE UNAVAILABLE - DMOS NOT ALLOWED
TABLE: AMAOPTS
>pos RECORD_MC260
    RECORD_MC260          OFF
>lis
    OPTION                SCHEDULE
-----
    RECORD_MC260          OFF
>cha
JOURNAL FILE UNAVAILABLE - DMOS NOT ALLOWED
ENTER Y TO CONTINUE PROCESSING OR N TO QUIT
>y
AMASEL: OFF
>on
TUPLE TO BE CHANGED:
    RECORD_MC260          ON
ENTER Y TO CONFIRM, N TO REJECT OR E TO EDIT.
>y
TUPLE CHANGED
JOURNAL FILE INACTIVE

```

Error messages

The following table explains error messages that can occur when you attempt to datafill table AMAOPTS.

	Explanation	User action
ERROR: LNP Billing options may not be activated unless Software Optionality Control option LNP00200 is ON.	SOC option LNP00200 is in the IDLE state.	Activate SOC option LNP00200. Activate the LNP billing option (again).

Table history

SN09 (DMS)

New option RECORD_MC260. This activates and deactivates Module 260 inclusion. AMA billing Module 260 captures originating and terminating agent component and protocol information for packet network agents (activity A00009508).

New option RECORD_MTZ. This switch-wide option allows customers to use the MTZ option and decide whether or not they want to record the modified timestamp (activity A00009252).

SN08 (DMS)

A new option MC130_FOR_CLF is introduced as part of activity A00006980.

Table AMAOPTS migrated from *DMS-100 Family DMS-100 MMP Customer Data Schema Reference Manual Volume 1 of 12*, 297-9051-351.07.02.

AMASRVID

Table name

TOPS AMA Service Identification Table

Functional description

Table AMASRVID provides a method to associate a call origination type and a service to a numeric value that is used in the service identification field of the automatic message accounting (AMA) record. This service identification field is in AMA records that contain the general assistance service module and the listing services service module.

This table is accessed by a two-part field that consists of the call origination type and the call service type. Table AMASRVID maps these fields to a numeric value (900 to 998) that is used in the service identification field of the AMA record. If an AMA record is formatted for a call type that is not defined in this table, a BELLCORE specified value is recorded.

Datafill sequence and implications

There is no requirement to datafill other tables prior to table AMASRVID.

AMASRVID (continued)**Datafill**

The following table lists datafill for table AMASRVID.

Field descriptions (Sheet 1 of 2)

Field	Subfield or refinement	Entry	Explanation and action
COSERV		see subfields	Call origination service. This field consists of subfields COTYPE and SERVICE. These combined fields identify the call as dialed by the subscriber and the service provided to that subscriber.
	COTYPE	alphanumeric (up to 8 characters)	<p>Call origination type. Enter the call origination type. This field identifies how the call is dialed by the subscriber. COINTEST, BOOK and DATABASE are valid call origination types. For a complete list of call origination types, see table TOPS.</p> <p>If translations directs the call to table TOPS, the call origination corresponds to the index in table TOPS. If translations does not access table TOPS, the following default call origination types are applied to the call:</p> <ul style="list-style-type: none"> • OH for 0- • OA for 0+ • DD for 1+ calls requiring operator handling • CAMA for 1+ station calls • RCAMA for RONI calls

AMASRVID (end)**Field descriptions (Sheet 2 of 2)**

Field	Subfield or refinement	Entry	Explanation and action
	SERVICE	DASERV INTCSERV or TASERV	Service. Enter the service type associated with the call origination type. Service types DASERV (Directory Assistance Service) and INTCSERV (Intercept Service) are recorded in the listing services module. A service type of TASERV (Toll and Assistance Service) is recorded in the general assistance module. The value INTCSERV can be datafilled in field SERVICE, however that value is not currently supported.
SERVID		900 to 998	Service identification. Enter a service identification. Any entry outside the range 900 to 998 causes tuple rejection.

Datafill example

The following example shows sample datafill for table AMASRVID.

MAP display example for table AMASRVID

COSERV SERVID		
CAMA	DASERV	911

AMATKOPT**Table name**

AMA Trunk Group Option

Functional description

Table AMATKOPT allows the application of Bellcore-format automatic message accounting (AMA) options to separate trunk groups. The options can be applied to the entire trunk group.

Datafill sequence and implications

The following tables must be datafilled before table AMATKOPT:

- CLLI
- TRKGRP

Table size

0 to 8191 tuples

Datafill

The following table lists datafill for table AMATKOPT.

Field descriptions (Sheet 1 of 3) (Sheet 1 of 3)

Field	Subfield	Entry	Explanation and action
CLLI		alphanumeric (1 to 16 characters)	<i>Common language location identifier</i> Enter the code that represents the trunk group in the common language location identifier (CLLI) table.
OPTIONS		see subfield	<i>Options</i> This field consists of subfield OPTION.
	OPTION		<i>Option</i> Enter the options and associated subfields that are assigned to the trunk group. Each option and its subfield are separated by a space. End the option list with a \$.
		AMA CLID	AMA calling line identification
		AMA TEST	AMA test call trunk

AMATKOPT (continued)

Field descriptions (Sheet 2 of 3) (Sheet 2 of 3)

Field	Subfield	Entry	Explanation and action
		CCTSEIZE	Carrier connect circuit seizure time. This option establishes the BILL carrier connect AMA functionality. Option CCTSEIZE applies to the following trunk signaling protocols: <ul style="list-style-type: none"> • IBN7 • BTUP (U.K. variant of national user part) • ETSI ISUP • FTUP • New Common Carrier Interface Number 7 Version 2 (NCCI#7 V2) and ISDN access indicator
		CLGINFO	Calling party category option. This option supports Brazilian R2, Brazilian TUP and Brazilian ISUP protocols.
		CNAR	Connecting network option
		EAORGSUP	Equal access originating AMA suppression
		EATRMSUP	Equal access termination AMA suppression
		ENTRYID	AMA entry identification
		INTRCPTBILL	Intercept billing
		LSPBILL	Local service provider billing
		OABILL	Operated-assisted call billing
		POIBILL*	Point-of-interconnect billing
		RECORDCHN	Record charge number
		RECORDCPN	Calling number recording
		REVALL	Revenue allocation
		TERMSDY	Trunk terminating usage study
		TGMU	Trunk group member usage
		TRKINFO	Trunk information
		USERCLI	User provided calling line identity

AMATKOPT (continued)

Field descriptions (Sheet 3 of 3) (Sheet 3 of 3)

Field	Subfield	Entry	Explanation and action
		IC_CLI	Incoming calling line identity. When this option is datafilled, the CLI of an incoming JI-ISUP IAM is captured in AMA module code 046.
		IC_CDPN	Incoming called party number. When this option is datafilled, if the pretranslated called party digits on a JI-ISUP call differ from the TERM OPEN digits in the base <i>AMA structure</i> , then the pretranslated digits are captured in an <i>AMA module code 612 - with generic context ID of IC_CDPN_DIGITS (generic context ID = 80033)</i> .
		ADDBLNUM	Additional billing number. Used on JI-ISUP for capture of (for example) generic number or redirecting number in AMA module code 612 (generic context ID = 80015).
		AMASRVBL	AMA service billing. Used on JI-ISUP for capture of service related billing information for intelligent network (IN), notification of time and charge (NTC), and DN screening features. The information is captured in AMA module code 611 (generic context ID = 80010).
		UUIAMA	User to user information - AMA. The user-to-user information (UUI) parameter can be present in the JI-ISUP IAM, ACM, ANM, and REL messages. If this option is datafilled, the contents of the UUI parameter are captured in module code 611 with generic context ID = 80009.

OPTION = AMACLID

Option AMACLID AMA calling line identification (CLI) provides CLI within AMA records generated on calls whose originating physical port is a trunk. This option is applicable to incoming or any of the following two-way trunks:

- IBN7
- FTUP

AMATKOPT (continued)

- ETSI ISUP
- DPNSS

Field descriptions for conditional datafill

Field	Subfield	Entry	Explanation and action
	OPTION	AMACLID	<i>Option</i> Enter AMACLID to enable the AMA calling line identification option.

OPTION = AMATEST

Option AMATEST (AMA test) provides the operating company with the ability to designate an originating or terminating trunk as an AMA test call trunk.

If such a call does not produce a billing record before this option was available, it does not produce one with option AMATEST enabled. A call to or from a trunk that has option AMATEST enabled produces a billing record that is marked by the digit 1 (one) in the fourth character position of the study indicator field. The regional accounting office is responsible for recognizing these types of records as test calls.

If AMATEST is present, the AMAB200 log generates and is controlled by option LOGTEST in table AMAOPTS. The entry for option LOGTEST must be on or off to generate the AMAB200 log.

Field descriptions for conditional datafill

Field	Subfield	Entry	Explanation and action
	OPTION	AMATEST	<i>Option</i> Enter AMATEST to assign the AMATEST option to the trunk group and datafill subfield MEMSEL.
	MEMSEL	ALL or MEMBER	<i>Member selector</i> Enter ALL to indicate all members of the trunk group, or enter MEMBER to include only selected members. If MEMBER is entered, datafill subfield MEMBER.
	MEMBER	0 to 9999	<i>Member number</i> Enter the trunk group member number.

AMATKOPT (continued)**OPTION = CCTSEIZE**

Option CCTSEIZE provides the carrier connect circuit seizure (CCTSEIZE) time to perform an accurate interadministration accounting. Activated for each trunk group individually, this feature is datafillable only for IBN7, BTUP, ETSI ISUP, and NCCI#7 V2 trunks.

Field descriptions for conditional datafill

Field	Subfield	Entry	Explanation and action
	OPTION	CCTSEIZE	<p><i>Option</i></p> <p>Enter CCTSEIZE to enable the BILL carrier connect AMA option. Also, set parameter UNIVERSAL_AMA_BILLING in office parameter table OFCENG to Y, to enable this option.</p>

OPTION = CLGINFO

This option can contain datafill entered only against incoming or two-way ETSI ISUP, SSUTR2, BTUP, R2 or Red Book TUP trunks. When option CLGINFO is added to table AMTKOPT, a warning is generated describing that Module 611 is produced.

The purpose of CLGINFO is to capture the calling party category, the protocol indicator and the ISDN access indicator within an AMA record for the following protocols:

- SSUTR2
- BTUP
- ETSI ISUP and all variants
- Red Book TUP
- R2

This option appends module 611 to any AMA billing record generated. The module 611 generated has a context identifier of 80027, identifying that the

AMATKOPT (continued)

module holds calling information. Module 611 is produced only if an AMA record is also triggered for the call.

Field descriptions for conditional datafill

Field	Subfield	Entry	Explanation and action
	OPTION	CLGINFO	<p><i>Option</i></p> <p>Enter CLGINFO to append module 611 (with a context identifier of 80027) to AMA billing records generated for incoming or two-way ETSI ISUP, SSUTR2, BTUP, R2 or Red Book TUP trunks.</p>

Option = CNAR

Option CNAR generates the Connecting Network Access Record for the specified trunk group. It prompts the operating company personnel to provision field LCNAR, field RECORDBTN, and enter a 10-digit billing number. This option is combined with field CLLI. Option CNAR is only applicable to incoming or two-way trunks.

Option CNAR is valid for the following trunk groups:

- IT (MF, DT, DP, Q764)
- TI (MF, DT, DP, Q764)
- T2 (MF, DT, DP, Q764)
- SC
- OC

AMATKOPT (continued)

- OP
- OI

Field descriptions for conditional datafill in option CNAR

Field	Subfield	Entry	Explanation and action
	OPTION	CNAR	<p>Enter CNAR for connecting network access record. This prompts the operating company personnel to datafill field LCNAR, RECORDBTN {Y, N} and a 10-digit billing number. CNAR consists of three fields, BILLNO, LCNAR, and RECORDBTN combined.</p> <p>Note: This option enables the connecting network access record generation for the specified trunk group.</p>
	BILLNUM	10-digit vector {0,1,2,3,4,5,6, 7,8,9}	<p>Enter a 10-digit billing number. This field is mandatory and is bound against option CNAR. The billing number is used to populate the originating billing number field in the CNAR Automatic Message Accounting (AMA) record, if ANI of the calling party is not received.</p> <p>Note: BILLNUM is only used by the CNAR record and does not affect other billing records.</p>
	LCNAR	Y or N	<p>Enter Y or N. If set to Y, the connecting network access record is generated when an LNP query is performed for the call originated by the specified CLLI. If set to N, the CNAR value is generated for all calls originated by the specified CLLI.</p>
	RECORDBTN	Y or N	<p>Enter Y or N. The default for the Record billing number for each trunk is N.</p>

OPTION = EAORGSUP

Option EAORGSUP enables the AT to suppress the CC110 when the ATC trunk has this option. If an advanced intelligent network (AIN), direct inward system access (DISA), 800 plus (800P), enhanced 800 (E800), private virtual network (PVN), or call forwarding (CFW) are encountered in the AT then no billing records are suppressed. This option has no impact in a DMS-100.

AMATKOPT (continued)

The following call types are supported:

- CELL -> MF/ISUP ATC
- ISUP IT CELL 2A -> MF/ISUP ATC

Field description

Field	Subfield	Entry	Explanation and action
	OPTION	EAORGSUP	Option Equal access originating AMA suppression.

OPTION = EATRMSUP

Option EATRMSUP enables the AT to suppress the CC119 when the ATC has this option. If an AIN, DISA, CFW, or PVN are encountered in the AT then the CC119 is NOT suppressed. This option has no impact in a DMS-100 switch.

The following call types are supported:

- MF/ISUP ATC -> MF/ISUP IT
- MF/ISUP ATC -> CELL

Note: The ISUP IT trunk does not require the CELL 2A option to suppress the CC119.

Field description

Field	Subfield	Entry	Explanation and action
	OPTION	EATRMSUP	Option Equal access terminating AMA suppression.

OPTION = ENTRYID

Option ENTRYID enables the information to be passed over the ISDN user part (IBN7) trunk to make the AMA point-of-entry identification a network-wide service. Option ENTRYID is exclusive to the existing option AMACLID. Both options cannot be selected against the same trunk. A datafill against the outgoing end of ISUP trunk option ENTRYID specifies whether point-of-entry identification information is added to ISUP Aims as a charge number optional parameter. Datafill against the incoming end of an IBN7 trunk option ENTRYID specifies whether point-of-entry identification information

AMATKOPT (continued)

is looked for in an incoming ISUP IAM in the charge number optional parameter.

Field descriptions for conditional datafill

Field	Subfield	Entry	Explanation and action
	OPTION	ENTRYID	<p><i>Option</i></p> <p>Enter the option ENTRYID to enable information to pass over the ISDN user trunk (IBN7) to make the AMA point-of-entry identification a network wide service.</p>

OPTION = INTRCPTBILL

Option INTRCPTBILL allows recording of calls receiving intercept treatment over the assigned trunk group.

Field descriptions for conditional datafill

Field	Subfield	Entry	Explanation and action
	OPTION	INTRCPTBILL	<p><i>Option</i></p> <p>Enter the option INTRCPTBILL for intercept billing.</p>

OPTION = LSPBILL

Option LSPBILL provides per trunk group LSPI recording control for selected interswitch trunk groups. Users can control forced trunk group recording differentiated by call attempts and/or call completions and incoming/outgoing trunks on selected interswitch public trunk types. Turn on option RECORDED_TRUNK_LSPI in table AMAOPTS to activate option LSPBILL.

Field descriptions for conditional datafill (Sheet 1 of 2) (Sheet 1 of 2)

Field	Subfield	Entry	Explanation and action
	OPTION	LSPBILL	<p><i>Option</i></p> <p>Enter the option LSPBILL for per trunk group LSPI recording control for selected interswitch public trunk types. Option LSPBILL has the following control fields.</p>
	INCOMING	Y or N	<p>This field controls forced AMA recording for incoming calls over this trunk when the system normally does not record billing.</p>

AMATKOPT (continued)

Field descriptions for conditional datafill (Sheet 2 of 2) (Sheet 2 of 2)

Field	Subfield	Entry	Explanation and action
	OUTGOING	Y or N	This field controls forced AMA recording for outgoing calls over this trunk when the system normally does not record billing.
	CIRCUIT	Y or N	This field controls whether the circuit usage module appends the AMA record for calls that use this trunk.
	INCOMING_UNANS	Y or N	This field controls forced AMA recording for call attempts over incoming trunks when the system does not normally record billing.
	OUTGOING_UNANS	Y or N	This field controls forced AMA recording for call attempts over outgoing trunks when the system does not normally record billing.

OPTION = OABILL

Option OABILL allows the generation of a local AMA record in an originating office for an operator-assisted (OA) call utilizing a specific operator (OP) trunk group. This option applies to North American offices using Bellcore format AMA billing.

Field descriptions for conditional datafill

Field	Subfield	Entry	Explanation and action
	OPTION	OABILL	<i>Option</i> Enter the option OABILL.

OPTION = POIBILL

Option POIBILL (point-of-interconnect billing) indicates an incoming or outgoing point-of-interconnect (POI). The datafill indicates that an AMA record is generated every time the incoming or outgoing trunk is seized regardless of whether the call succeeded or not. Option POIBILL is only

AMATKOPT (continued)

implemented for Integrated Business Network (IBN) Australian telephone user part (ATUP) trunks for unsuccessful calls.

Field descriptions for conditional datafill

Field	Subfield	Entry	Explanation and action
	OPTION	POIBILL	<i>Option</i> Enter POIBILL to define the trunk as point-of-interconnect and datafill subfield GENRCVAL.
	GENRCVAL	800 to 999	<i>Generic call code value</i> Enter the generic call code value (GENRCVAL).

OPTION = RECORDCHN

Option RECORDCHN enables the system to record the charge number for calls. This service supports ISUP IT and PRI trunks.

Field descriptions for conditional datafill

Field	Subfield	Entry	Explanation and action
	OPTION	RECORDCHN	Record Charge Number. Enter RECORDCHN to assign the charge number on the ISUP IT or PRI trunks. The default = absent.

OPTION = RECORDCPN

Option RECORDCPN enables the system to record the calling party number for calls. The assignment of the CCNREC option to a trunk group activates calling number recording for originating calls. This service supports ISUP IT and PRI trunks.

Field descriptions for conditional datafill

Field	Subfield	Entry	Explanation and action
	OPTION	RECORDCPN	Calling Number Recording. Enter RECORDCPN to assign the CCNREC option to the trunk group. The system selects the trunk CLLI and assigns an associated option and its subfields to the trunk group.

AMATKOPT (continued)**OPTION = REVALL**

Option REVALL (revenue allocation) provides the operating company with the ability to generate local AMA records for toll coin calls for the purpose of revenue allocation.

Field descriptions for conditional datafill

Field	Subfield	Entry	Explanation and action
	OPTION	REVALL	<p><i>Option</i></p> <p>Enter REVALL to indicate that LAMA records are generated for the purpose of revenue allocation.</p>

OPTION = TERMNPA

Option TERMNPA (terminating numbering plan area) provides the ability to specify a trunk's terminating NPA used by the AMA system. For offices that serve two or more Naps, this enhancement allows them to provide more accurate information in their billing records for the called number field.

Field descriptions for conditional datafill

Field	Subfield	Entry	Explanation and action
	OPTION	TERMNPA	<p><i>Option</i></p> <p>Enter TERMNPA to specify the terminating numbering plan area (NPA) for a trunk group and datafill subfield CONNGNPA.</p>
	CONNGNPA	numeric (3 digits)	<p><i>Connecting NPA</i></p> <p>Enter the terminating numbering plan area (NPA) for the common language location identifier (CLLI).</p>

OPTION = TERMSDY

Option TERMSDY (trunk terminating usage study) enables terminating AMA billing information for trunk types IBNTO and IBNT2. If option TERMSDY

AMATKOPT (continued)

is added to an IBNTO or IBNT2 trunk, an AMA record with call code 036 is generated.

Field descriptions for conditional datafill

Field	Subfield	Entry	Explanation and action
	OPTION	TERMSDY	<i>Option</i> Enter TERMSDY to indicate that terminating AMA billing information for IBNTO and IBNT2 trunks is generated.

OPTION = TGMU

Option TGMU (trunk group member usage) provides the operating company with the ability to generate a trunk group member usage (TGMU) Bellcore (BC) AMA format billing record in the DMS-200 toll switch with the new call code 950 for both incoming and outgoing trunks. This new call code gives the revenue accounting office (RAO) the ability to recognize that the billing record contains trunk information. Option TGMU is only valid on intertoll trunks.

Field descriptions for conditional datafill

Field	Subfield	Entry	Explanation and action
	OPTION	TGMU	<i>Option</i> Enter TGMU to indicate that a TGMU billing record is produced for the selected trunk group.

OPTION = TOPS_EA251CC

TOPS_EA251CC option determines whether or not call type code 251, Inter-LATA 1+, 0+, 0- Call Transfer, should be included in Phase 2 EBAF AMA on a trunk group basis for calls that tandem through TOPS to ATC trunks.

Field descriptions for conditional datafill

Field	Subfield	Entry	Explanation and action
	OPTION	TOPS_EA251CC	<i>Option</i> Enter TOPS_EA251CC for Inter-LATA call transfers.

AMATKOPT (continued)**OPTION = TRKINFO**

Option TRKINFO (trunk information) provides the operating company with the ability to indicate that module code 104 is appended to AMA billing records produced by calls routed over the selected trunk group. To append the module code to a billing record, a billing record must be produced for the call, and in table AMATKOPT, option TRKINFO must be added to the CLLI of the trunk group that the call was routed over. Module code 104 contains the trunk group number, trunk member number, and the trunk direction. Option TRKINFO is the only option supported by GSF031 Equal Access.

Field descriptions for conditional datafill

Field	Subfield	Entry	Explanation and action
	OPTION	TRKINFO	<i>Option</i> Enter TRKINFO to append module code 104 to any AMA billing records produced by calls routed over the selected trunk group.

OPTION = USERCLI

Option USERCLI allows operators in France to capture the Designated Supplementary Number (NDS) into appended module code 046. Module code 046 contains the NDS and the Source of Charge Number of 5 (USERCLI).

Field descriptions for conditional datafill

Field	Subfield	Entry	Explanation and action
	OPTION	USERCLI	<i>Option</i> Enter USERCLI option to a tuple in table AMATKOPT to add module code 046 to AMA billing records generated for incoming or two-way SSUTR2 trunks. Activate SOC Option RBIL0007 to activate this option.

Datafill example

The following examples show sample datafill for table AMATKOPT.

The second entry in the first example shows the trunk group OPDP1 with the option AMATEST applied to all members. Option REVALL indicates that toll coin calls have local LAMA records generated.

AMATKOPT (continued)**MAP display example for table AMATKOPT**

CLLI	OPTIONS
LNTOPS2	OABILL \$
ISUPITIC	TGMU \$
OPDP1	AMATEST ALL REBALL \$

MAP display example for table AMATKOPT

CLLI	OPTIONS
ISUP2WITRTPBI	(AMACLID) (AMATEST) (ENTRYID) (INTRCPTBILL) (TERMSDY) (TRKINFO) (CETSEIZE) (CLGINFO) \$

MAP display example for LSPBILL option in table AMATKOPT

CLLI	OPTIONS
ISUP2WITRTPB1	(LSPBILL Y Y Y N N) \$

MAP display example for RECORDCHN option in table AMATKOPT

CLLI	OPTIONS
ISUP2WITRTPBI	(TGMU) (RECORDCHN) (RECORDCPN) \$
ISUP2WITEA	(CNAR N Y 9199918425) (RECORDCPN) \$
AL7ITICS7	(RECORDCPN) \$
AL7ITOGS7	(TGMU) (RECORDCHN) \$
AT9CELL2W	(RECORDCPN) (TRKINFO) \$

AMATKOPT (continued)

MAP display example for RECORDCPN option in table AMATKOPT

CLLI	OPTIONS
ITCELL2WA	(TGMU) (RECORDCPN) \$

MAP display example for CLGINFO option in table AMATKOPT

CLLI	OPTIONS
BZSR2IDIGANC	(CLGINFO) \$

Table history

MMP15

Added Brazilian R2, Brazilian TUP and Brazilian ISUP protocols to extend the CLGINFO option.

MMP14

Added options IC_CLI, IC_CDPN, ADDBLNUM, AMASRVBL, and UIIAMA.

NA012

Added options EAORGSUP, EATRMSUP, RECORDCHN, and subfield RECORDBTN.

MMP12

Added option USERCLI to table AMATKOPT.

EUR010

Added option CLGINFO for AJ5340.

NA010

Added option LSPBILL and associated control fields. Replaced option CCNREC with option RECORDCPN. Added note regarding options POIBILL and TOPS_EA125CC to “Field descriptions” table.

AMATKOPT (end)

APC009

Added NCCI#7 V2 to the list of trunk types against which option CCTSEIZE can be datafilled.

NA008

Added option OABILL which controls whether or not an operator-assisted call utilizing a specific operator trunk group generates a local AMA record in the originating office. This applies to North American offices using Bellcore format AMA billing.

NA007

Added option CNAR, field BILLNO and field LCNAR for Local Number Portability.

GSF031

Added text stating that option TRKINFO functionality is the same in GSF software as it is in non GSF software.

EUR003

Added option CCTSEIZE, which provides the carrier connect circuit seizure (CCTSEIZE) time, using the expanded Bellcore AMA format (EBAF) call recording system, so that accurate inter-administration accounting is performed.

AMAXLAID

Table name

AMA Translations Identification Table

Functional description

Table AMAXLAID defines automatic message accounting (AMA) translation identifiers. Translation identifiers datafilled in table AMAXLAID are accessible to translations and to table FLEXAMA. The translation identifiers are defined by the operating company.

When an AMA translation identifier is defined, it can specify a call type, a service feature, or both. The call types that can be assigned also support an override specification, to either override all predefined DMS-100 call types or to select precedence. The call types that can be granted precedence within the flexible call type (FLEXCTYP) assignment are as follows:

- LOCAL (local calls receive precedence) - includes calls set to NP (no prefix) local in field TYPCALL of table STDPRTCT.STDPRT, or calls set to a class of LCL (local) in the universal translation HEAD and CODE tables.
- TOLL (toll calls receive precedence) - includes calls set to DD (direct dialed) in field TYPCALL of table STDPRTCT.STDPRT, or calls set to a class of NATL (national) or INTL (international) in the universal translation HEAD and CODE tables.
- IC (equal access receives precedence) - enables equal access AMA to be overridden by flexible AMA.
- VPN (virtual private network [VPN] calls receive precedence) - enables the AMA typically generated when using the VPN selector in the universal translation HEAD and CODE tables to be overridden by a flexible AMA.

Datfill sequence and implications

There is no requirement to datafill other tables prior to table AMAXLAID.

The following tables must be datafilled after table AMAXLAID.

- FLEXAMA
- all universal translation HEAD or CODE tables
- subtable STDPRTCT.AMAPRT

Table size

0 to 255 tuples

AMAXLAID (continued)**Datafill**

The following table lists the datafill for table AMAXLAID.

Field descriptions (Sheet 1 of 2)

Field	Subfield or refinement	Entry	Explanation and action
XLAIKEY		alphanumeric (up to 8 characters)	<i>Translation identification</i> Enter the Automatic Message Accounting (AMA) translation identification name. This is the key field of the table.
DEFAULT		see subfield	<i>AMA translation id default</i> This field consists of the following subfields:
	DFLTSEL	DFLT or NODFLT	<i>Default selector</i> To specify a call type or service feature, enter DFLT (default) and datafill refinement OPT. Otherwise, enter NODFLT (no default) and leave all refinements blank.
OPT	XLAOPTN	vector of up to 8 options	<i>Option</i> This refinement is a vector of translation options, each consisting of subfield XLAOPTN and its associated refinements. This option can only be used with DFLT.
	XLAOPTN		<i>Translation option</i> Datafill the refinements for each option as follows.
	FLEXCLGI	FLEXCLGI	<i>Flexible calling party category</i> Enter FLEXCLGI to trigger module code 611 for calls over incoming or two-way ETSI ISUP, SSUTR2, BTUP, R2 and Red Book TUP trunks. Module code 611 is produced only if an AMA record is triggered also for the call. This option supports Brazilian R2, Brazilian TUP and Brazilian ISUP protocols.

AMAXLAID (continued)

Field descriptions (Sheet 2 of 2)

Field	Subfield or refinement	Entry	Explanation and action
			<p>FLEXCLGI can also be entered in table FLEXAMA. If both tables AMAXLAID and FLEXAMA are accessed in translations then the FLEXCLGI option datafill in table AMAXLAID is ignored. This means that if table FLEXAMA does not contain the FLEXCLGI option then the module code 611 (context identifier of 80027) is not generated due to the FLEXCLGI option in table AMAXLAID. The only exception is when table FLEXAMA contains the option GRPDATA. It is not possible to datafill FLEXCLGI as a sub-option to GRPDATA. In this case, module code 611 (context identifier of 80027) is generated due to FLEXCLGI option present in table AMAXLAID.</p> <p>The Module 611 produced has a context identifier of 80027 to indicate that it contains calling party information.</p>
	FLEXCPNI	see subfields	<p><i>Flexible Calling/Called Party Numbering Plan Information</i></p> <p>This option captures Numbering Plan Indicator (NPI) and Nature Of Address (NOA) or Type Of Number (TON) information as described below.</p>
	FLEXCTYP	see subfield	specifies a flexible call type
	FLEXDBCK <callcode>	<callcode> is numeric, 800 to 999	<p>Enter FLEXDBCK to generate AMA records for ISUP (DFT) Dropback call diversions, where diversion routes the call back to the originating node.</p> <p>The <callcode> entered appears in the AMA record.</p> <p>This functionality is under SOC control, order code PBXA0014.</p>
	FLEXSF	see subfield	specifies a flexible service feature
	FLEXRJCT	see subfield	triggers AMA records for rejected or failed call

AMAXLAID (continued)**XLAOPTN = FLEXCPNI**

If the entry in field DEFAULT is FLEXCPNI, datafill the refinements as explained in the following table.

Note: Both tables FLEXAMA and AMAXLAID can have the option FLEXCPNI datafilled. However, preference is given to datafill in table FLEXAMA in some cases. For example, if FLEXAMA is accessed and has a content of XLADATA or ALLDATA and does not have the FLEXCPNI option, no module code 611 or module code 612 is produced, regardless of datafill in table AMAXLAID.

Field descriptions for conditional datafill (Sheet 1 of 2)

Field	Subfield or refinement	Entry	Explanation and action
	IC_CGPN_INFO	Y or N	<p><i>Incoming Calling Party Number (CGPN) Information</i></p> <p>Enter Y to capture the incoming CGPN Numbering Plan Indicator (NPI) and Nature Of Address (NOA) or Type Of Number (TON) for supported protocols in AMA Module 611 (context identifier 80050).</p> <p>Note the AMAOPTS option IC_CGPN_INFO_REQD must be ON.</p> <p>The protocols supported are:</p> <p>ETSI ISUP</p> <p>IBN7</p> <p>FTUP SSUTR2</p> <p>ETSI PRI</p> <p>VN4-PRI</p> <p>AUST PRI (TS14 PRI)</p> <p>ETSI BRI</p> <p>VN4-BRI</p> <p>QSIG</p> <p>INAP</p>

AMAXLAID (continued)

Field descriptions for conditional datafill (Sheet 2 of 2)

Field	Subfield or refinement	Entry	Explanation and action
	IC_CDPN_INFO	Y or N	<p>Incoming Called Party Number (CDPN) Information</p> <p>Enter Y to capture the incoming (pre-translations) CDPN NPI and NOA or TON for supported protocols in AMA Module 611 (context identifier 80050).</p> <p>Note the AMAOPTS option IC_CDPN_INFO_REQD must be ON.</p>
	OG_CDPN_INFO	Y or N	<p><i>Outgoing Called Party Number Information</i></p> <p>Enter Y to capture the outgoing (outpulsed) CDPN NPI and NOA or TON for supported protocols in AMA Module 611 (context identifier 80050).</p>
	OG_CDPN_DIGS	Y or N	<p><i>Outgoing Called Party Number Digits</i></p> <p>Enter Y to capture the outgoing (outpulsed) CDPN digits for supported protocols in AMA Module 612 (context identifier 80051).</p> <p>Digits are captured only if they are different from those captured in the Terminating Open Digits field of the base AMA structure.</p> <p>Supported protocols are as for other FLEXCPNI options plus DPNSS and BTUP.</p>

XLAOPTN = FLEXCTYP

If the entry in field XLAOPTN is FLEXCTYP, datafill refinement CTYP as explained in the following table.

Field descriptions for conditional datafill

Field	Subfield or refinement	Entry	Explanation and action
	CTYP	FLATRATE, FREE, GENERIC, or STNPAID	<p><i>Call type</i></p> <p>Enter the AMA call type to use for the call. Datafill the refinements described below.</p>

AMAXLAID (continued)**CTYP = NONDA555, DA555, DATAPATH, or DA411**

If the entry in field CTYP is NONDA555, DA555, DATAPATH, or DA411, datafill no additional refinements.

CTYP = GENERIC

If the entry in field CTYP is GENERIC, datafill refinement GENRCVAL as shown in the following table.

Field descriptions for conditional datafill

Field	Subfield or refinement	Entry	Explanation and action
	GENRCVAL	800 to 999	<i>Generic call code value</i> Enter the generic call code value.

CTYP = GENERIC, STNPAID, FLATRATE, INVERTLT, or FREE

If the entry in field CTYP is GENERIC, STNPAID, FLATRATE, INVERTLT, or FREE, datafill refinement OVRDSEL as shown in the following table.

Field descriptions for conditional datafill

Field	Subfield or refinement	Entry	Explanation and action
	OVRDSEL	PRCDENCE or OVRDALL	Enter PRCDENCE to selectively enable precedence, and datafill refinement PRCDENCE. Any call type specified in refinement PRCDENCE, if selected, overrides the flexible AMA assignment. Enter OVRDALL to override all predefined DMS call types, and leave refinement PRCDENCE blank.
	PRCDENCE	IC,LOCAL,TO LL,or VPN	<i>Precedence</i> This refinement is a vector of up to eight precedence option indexes. Enter the call type that can be granted precedence within the flexible call type (FLEXCTYP) assignment.

AMAXLAID (continued)**XLAOPTN = FLEXSF**

If the entry in field XLAOPTN is FLEXSF, datafill refinement SFEATVAL as shown in the following table.

Field descriptions for conditional datafill

Field	Subfield or refinement	Entry	Explanation and action
	SFEATVAL	800 to 999	<i>Service feature value</i> Enter the service feature value.

XLAOPTN = FLEXRJCT

If the entry in field XLAOPTN is FLEXRJCT, datafill refinement REJECTMOD as follows.

The FLEXRJCT option enables AMA records to be generated for billable, unanswered calls that are either rejected backwards (ie. remotely treated) or routed to a local treatment or to an announcement. For the case where the call is treated remotely, then the release cause value is captured in module 130 rather than the DMS treatment value.

Tuples containing the FLEXRJCT option in table AMAXLAID can be indexed by entries in subtable STDPRTCT.AMAPRT, or in universal translation xxHEAD and xxCODE tables.

Field descriptions for conditional datafill

Field	Subfield or refinement	Entry	Explanation and action
	REJECTMOD	Y or N	<i>Reject calls module</i> Enter Y if an AMA 130 module is to be appended to the AMA record for a billable, unanswered call that encounters treatment. Enter N if no AMA module is to be generated for a call that encounters local treatment.

Datafill example

The following example shows datafill for table AMAXLAID.

AMAXLAID (end)**MAP display example for table AMAXLAID**

XLAIDKEY	DEFAULT	FLEXCTYP	CTYP	GENRCVAL	OVRDSEL
FREE	DFLT	FLEXCTYP	FREE	800	OVRDALL \$
XLA1	NODFLT				
GENERIC1	DFLT	FLEXCTYP	GENERIC	800	PRCDENCE LOCAL \$ \$
GENERIC2	DFLT	FLEXSF	800		\$
GENERIC3	DFLT	FLEXCTYP	GENERIC	800	PRCDENCE LOCAL + VPN \$ +
	FLEXSF		900		\$
RJCT1	DFLT	FLEXCTYP	STNPAID	OVRDALL	FLEXRJCT Y (FLEXDBCK 850) \$

MAP display example for FLEXCLGI option in table AMAXLAID

CLLI	OPTIONS
BZR2AMA	DFLT (FLEXCTYP GENERIC 800 OVRDALL) (FLEXCLGI) \$

Table history**MMP15**

Added Brazilian R2, Brazilian TUP and Brazilian ISUP protocols to extend option FLEXCLGI.

MMP13

Added option FLEXCPNI for 59014037.

EUR010

Selector FLEXCLGI added to table for AJ5340.

EUR008

Selector FLEXDBCK added to table.

AMCODE

Table name

Ambiguous Code Table

Functional description

Table AMCODE is divided into subtables with each subtable identified by a unique XLANAME, previously datafilled in table AMHEAD. Each ambiguous code subtable translates one ambiguous code. Each ambiguous code subtable can have any number of tuples, but each subtable usually has two entries.

Datafill sequence and implications

The following tables must be datafilled before table xxCODE of the same system name:

- ACHEAD
- CTHEAD
- FAHEAD
- FTHEAD
- NSCHEAD
- OFCHEAD
- PXHEAD
- AMHEAD
- CDNCHAR
- NSCDEFS (if translation selector DBQ is used)
- TRKSGRP (if optional selector CGNDM for translation selector DMOD is used)

Note: The NSCDEFS table requires datafill first only for the Global software load.

If the optional selector CGNDM is used with translation selector DMOD, the default Calling Line Identity (CLI) must be datafilled in table TRKSGRP. Different default CLIs can be datafilled on requirements.

Optional selector CGNDM must also be datafilled in table ACCODE to activate the feature.

AMCODE (continued)

Only automatic number identification (ANI) and international metering (MTR) trunk group originations currently support the option selector CAMA. All other call types ignore this translation option.

For emergency calls translation, class EMRG has to be datafilled. This can be done before or after datafilling translation selector DMOD with option selector COODM. This requirement differentiates between normal mobile originated calls and emergency calls set up by a conventional SETUP message.

The following office parameters affect table ACCODE:

- ICAMA_REQUESTED in table OFCVAR
- IAA_REQUESTED in table OFCVAR
- IMEI_ACCEPTABLE_FOR_EMRG_CALL in table OFCVAR

For option selector CAMA (used in translation selectors CONT, DNRTE, and RTE), set office parameter ICAMA_REQUESTED in table OFCVAR to Y (yes) if international centralized automatic message accounting (ICAMA) detailed call recording is required.

An IAA record can be generated by selecting existing office parameter IAA_REQUESTED in table OFCVAR, and the CAMA selector.

Office parameter IMEI_ACCEPTABLE_FOR_EMRG_CALL in table OFCVAR provides an option for the network operator to accept emergency call setups from mobile stations that transmit the international mobile equipment identity (IMEI) instead of the international mobile subscriber identity (IMSI) or temporary mobile subscriber identity (TMSI). The default value allows emergency call setups with IMEI as the identifier where, for example, no serial interface module (SIM) is present.

Table size

There is no fixed maximum number of tuples in each subtable, but the maximum number of tuples is 16 382. The number of tuples is allocated dynamically.

Note: The maximum number of tuples can vary due to compression and expansion of tuples.

AMCODE (continued)**Datafill**

The following table lists datafill for table AMCODE.

Field descriptions (Sheet 1 of 2)

Field	Subfield or refinement	Entry	Explanation and action
XLANAME		alphanumeric (1 to 8 characters)	Translation name. Enter the name assigned to subtable AMCODE. The name must be datafilled in table AMHEAD.
NUMDIGS		0 to 30	Number of digits. Enter the number of digits to compare with the actual number of digits dialed.
RELATION		EQ, GE, or LE	Relationship. Enter the relationship that must be satisfied between the actual number of digits dialed and the value in field NUMDIGS. Enter EQ (equal to), GE (greater than), or LE (less than equal to).
XLADATA		see subfield	Translation data. This field consists of subfield XLASEL plus a set of options dependent on the entry in XLASEL.
CONTMARK		+ or \$	Continuation mark. Enter + if additional information for this tuple is contained in the next record. Otherwise, enter \$ to indicate the end of the tuple.
	XLASEL	CONT, DBQ, DMOD, DNRTE, FEAT, FEATINFO, HRC, IAC, NET, RTE, or TRMT	<p>Translation selector.</p> <p>Enter CONT and datafill its refinements if further translation is required.</p> <p>Enter DBQ and datafill its refinements to perform a database query.</p> <p>Enter DMOD and datafill its refinements if the input digit stream requires modification.</p> <p>Enter DNRTE and datafill its refinements if the input digits are routed.</p> <p>Enter FEAT and datafill its refinements if access to a feature is required.</p>

AMCODE (continued)**Field descriptions (Sheet 2 of 2)**

Field	Subfield or refinement	Entry	Explanation and action
			Enter FEATINFO and datafill its refinements to trigger the screening function.
			Enter HRC and enter datafill for its refinements to add the home routing code selector to local number portability applications.
			Enter IAC and datafill its refinements if the insertion of own area code is required when an ambiguous area code is found through translations.
			Enter RTE and datafill refinement RTE if a translation result was found, and translation is to terminate.
			Enter TRMT and datafill refinement TRMT if a call is routed to a treatment.

XLASEL = CONT

This selector is used if further translation is required. The next table to use is given by option XLT. Option CON in the head table entry for the current XLANAME determines whether the digits that were used to index the current table are to be consumed (that is, ignored by the next table). For example, in a pretranslator, the digits are not usually consumed, but they are consumed when continuing from the office code table to table DNINV. The consumed digits are not deleted from the digit register (they are ignored for the moment).

It is possible to datafill the tables so that the same table is explicitly reentered, but it is not recommended because it makes the sequence very difficult to follow and prone to error. (The same table refers to the same subtable in the same translation system. It is correct to enter a different subtable in the same translation system, but if option XLT is not used, this is not the case). If the same table is entered, it is datafilled explicitly.

If selector CONT is used, option XLT must be present in the code table tuple or in the default options (DFOP) of the corresponding head table. If selector CONT is used in the default tuple (DFLT), option XLT must be present there as well. Selector DMOD does not use the default options from the head table, so option XLT must be datafilled in the code table tuple as well.

AMCODE (continued)

Table AMAXLAID must be datafilled prior to selecting option AMAXLAID.

If the entry in field XLASEL is CONT, datafill the following refinements.

Field descriptions for conditional datafill (Sheet 1 of 14)

Field	Subfield or refinement	Entry	Explanation and action
	OPT	see subfield	Options. This field is a vector consisting of up to ten options. Each option consists of subfield OSEL and refinements that depend on the entry in subfield OSEL. For each option, specify the option selector (OSEL), followed by a space, and the refinements, each separated by a space. The entry is concluded by a \$ and datafill continues with field DFOP.
	OSEL	ACF, AMAXLAID, CALLCTRL, CAMA, CDN, CDNRTE, CHGIND, CLASS, CLIOVRD, CONSUME, CPCRTE, CPMCALL, DDIDX, DEST, EXTCIC, IAA, LNET, MM, MZONE, NETSRV, OSS, PCC, PF, PNRF, PRESEL PRIVL, QFT, SETCDN, TELETAXE, TOC, VPN, or XLT	<p>Option selector. The following options can be selected:</p> <p>Enter ACF, followed by a space, and datafill refinement ACF if the area code fence is defined.</p> <p>Enter AMAXLAID, followed by a space, and datafill refinement XLAID to specify an automatic message accounting (AMA) identity from within table AMAXLAID.</p> <p>Enter CALLCTRL, followed by a space, and datafill refinement CALLCTRL. The entry in refinement CALLCTRL indicates who has control of the call: the calling party, the called party, or both.</p> <p>Enter CAMA, followed by a space, and datafill refinement CLDFMT. The entry in field CLDFMT indicates whether the international centralized automatic message accounting (ICAMA) record is generated with the originally signaled directory number (DN) or the final public switched telephone network (PSTN) number.</p>

AMCODE (continued)**Field descriptions for conditional datafill (Sheet 2 of 14)**

Field	Subfield or refinement	Entry	Explanation and action
			<p>Enter CDN, followed by a space, and datafill refinement CDN to select the nature of address field. This field is used to identify the called party of the initial address message (IAM). It is used for Australian ISDN user part (AISUP) call translations.</p> <p>Enter CDNRTE to route the call using the called number name (CDNNAME) in the CDNCHAR table. If the CDNNAME is present on the incoming call or is set in the SETCDN option, translation proceeds to the CDNUXLA table. The CDNRTE option does not have refinements.</p> <p>Enter CHGIND to indicate whether the value of the charge indicator in the Backward Call Indicators should be overridden.</p> <p>CHGIND indicates whether to override the value of the charge indicator in the Backward Call indicators. The CHGIND option is available only for JCTV loads.</p> <p>Datafill the CHGIND field with the following values:</p> <ul style="list-style-type: none"> • ASIS-treat charge indicator as is • CHG-treat charge indicator as charge • NOCHG-treat charge indicator as no charge <p>Enter CLASS, followed by a space, and datafill refinement CLASS if the class of the dialed digits can be determined.</p> <p>Enter CLIOVRD, followed by a space, and enter datafill for refinement CLIOVRD. This option blocks or allows delivery of a calling line identity (CLI) for each call.</p> <p>Enter CONSUME, followed by a space, and datafill refinement CONDIGS to specify the number of digits that are consumed during translation.</p>

AMCODE (continued)

Field descriptions for conditional datafill (Sheet 3 of 14)

Field	Subfield or refinement	Entry	Explanation and action
			<p>Enter PCRTE to route the call using the calling party category (CPCNAME) from table CPCCHAR. If the CPCNAME is present on the incoming call, translation proceeds to table CPCUXLA. The PCRTE option does not have refinements.</p> <p>Enter CPMCALL, followed by a space, and datafill refinement CPMCALL to specify call billing against the called party instead of the calling party for intra-office calls.</p> <p>Enter DDIDX, followed by a space, and enter data for refinement DDIDX if a destination discount applies to the call.</p> <p>Enter DEST, followed by a space, and datafill refinement DEST if the destination is known.</p> <p>Enter EXTCIC, followed by a space, and datafill refinements SOURCE, SKIPDIGS, and CICSIZE. EXTCIC is the external carrier identification code that indicates a long distance carrier in the global environment. This option is only supported for TOPS calls. For further information, refer to functionality Global Competitive Access, GOS00006.</p> <p>Enter IAA and the datafill refinement IAA_INDEX to generate or modify IAA message parameters based on datafill in table IAACtrl.</p> <p>Enter LNET, followed by a space, and datafill refinement LNET if a logical network is required for metering.</p> <p>Enter MM, followed by a space, and datafill refinements MIN and MAX if the minimum and maximum dialed digits are known.</p> <p>Enter MZONE, followed by a space, and datafill refinement MZONE if metering is to be done on the call.</p>

AMCODE (continued)**Field descriptions for conditional datafill (Sheet 4 of 14)**

Field	Subfield or refinement	Entry	Explanation and action
			<p>Enter NETSRV and datafill refinement NETSRV_NAME to indicate a Japan network service.</p> <p>Enter OSS. This option does not have refinements.</p> <p>Enter PCC, followed by a space, and datafill refinement PCCDR if a pseudo country code is required.</p> <p>Enter PF, followed by a space, and datafill refinement PFDIGS if there are prefix digits in the digit stream.</p> <p>Enter PNRF to invoke the ported number recognition function. The LNP applications in the German market use this option. The PNRF option does not have refinements.</p> <p>Enter PRESEL, followed by a space, if the call is to be treated as a preselected carrier case.</p> <p>Enter PRIVL, followed by a space, and datafill refinement PRIVL if the user is a privileged user (for example, operators).</p> <p>Enter QFT, followed by OFF or ON to indicate if an outgoing route is capable of QSIG feature transparency.</p> <p>Note: Operating company personnel must not add the QFT option to a route unless the far-end node is QFT-capable.</p> <p>Enter SETCDN, followed by a space, and enter datafill for the CDNNAME refinement. The SETCDN option allows CDN routing when incoming agents are not available in table CDNCHAR.</p> <p>Enter TELETAXE. This option does not have refinements.</p>

AMCODE (continued)**Field descriptions for conditional datafill (Sheet 5 of 14)**

Field	Subfield or refinement	Entry	Explanation and action
			<p>Enter TOC, followed by a space, and datafill refinement CHG for the type of charge if the type of charge messaging is selected.</p> <p>Enter VPN, followed by a space, and datafill refinements ONNET and BILLABLE if the call routes through a service switching point (SSP) and feature package NTXH49AA or NTXH49AB (VPN - SSP) is in the switching unit.</p> <p>Enter XLT, followed by a space, and datafill refinement XLASYS if the call is to proceed to another translation system.</p>
	ACF	0 to 29	Area code fence. If the entry in subfield OSEL is ACF, datafill this refinement. Enter the number of digits between the beginning of the digits to currently index the table, and the end of the area code.
	BILLABLE	Y or N	Virtual private network billable call. If the entry in subfield OSEL is VPN, datafill this refinement. Enter Y if an AMA record is required for each VPN call. Otherwise, enter N. The system does not generate an AMA record if an address complete message (ACM) of address complete - no charge is returned, or if the call terminates in the SSP on a line with the free number terminating (FNT) option.
	CALLCLASS	PRESELECT OVERRIDE, CSN,TRUNK	Call class. If the entry in subfield OSEL is PRESEL, enter PRESELECT to treat the DN as a preselected call. Enter OVERRIDE to permit the DN to use override codes. Enter CSN to treat the DN as a carrier specific number. Enter TRUNK to permit access to trunk originated calls.

AMCODE (continued)**Field descriptions for conditional datafill (Sheet 6 of 14)**

Field	Subfield or refinement	Entry	Explanation and action
	CALLCTRL	CALLED, CALLING, LAST, or MUTUAL	<p>Call control. If the entry in subfield OSEL is CALLCTRL, datafill this refinement. Enter one of the following values to specify the party controlling the call:</p> <ul style="list-style-type: none"> • If the entry is CALLED and the called party goes on-hook first, the call is released immediately. If the calling line goes on-hook first and does not reanswer, the connection is not released until the called line goes on-hook. There are no time-outs, and the calling party is allowed to reanswer until the called line goes on-hook. <p>Calls to lines with option ESG must have CALLCTRL(CALLED).</p> <p>Calls terminating on an International Traffic Operator Position System (ITOPS) must have CALLCTRL (CALLED).</p> <ul style="list-style-type: none"> • If the entry is CALLING and the calling line goes on-hook first, the call is released immediately. If the called line goes on-hook first, the called party is allowed to reanswer within a datafilled reanswer time-out or until the calling line goes on-hook. If the time-out expires or if the calling line goes on-hook, the calling party releases the call and the called party is set to idle. • If the entry is LAST, the call is released when the later of the called party or the calling party goes on-hook. If either party goes on-hook, that party is allowed to reanswer within a datafilled reanswer time-out or until both parties go on-hook.

AMCODE (continued)

Field descriptions for conditional datafill (Sheet 7 of 14)

Field	Subfield or refinement	Entry	Explanation and action
			<p>Call control (continued). Enter one of the following values to specify the party controlling the call:</p> <ul style="list-style-type: none"> If the entry is MUTUAL and either line goes on-hook, the call is released immediately.
	CDNNAME	alphanumeric string	Called number name. If the entry in subfield OSEL is SETCDN, enter data for this refinement. The CDNNAME refinement allows CDN routing when incoming agents are not available in table CDNCHAR.
	CHG	SEND_ CHARGE or SEND_NO_ CHARGE	Charge. If the entry in subfield OSEL is TOC, datafill this refinement. Enter SEND_CHARGE to set the answer message (BTUP ANM) type of answer (TOA) string sent out from a node to SEND_CHARGE. Enter SEND_NO_CHARGE to set the answer message (BTUP ANM) type of answer (TOA) string sent out from a node to SEND_NO_CHARGE.
	CHGIND	CHARGE or NO_CHARGE	If the entry in subfield OSEL is CHGIND, enter either CHARGE to specify that the call will be charged, or NO_CHARGE to specify that the call will not be charged.
	CICSIZE	1 to 4	<p>CIC size. If the entry in subfield OSEL is EXTCIC, datafill this refinement. This field indicates how many digits are in the CIC. This field operates on the B (called) number, so it is assumed that the CIC is signalled as part of the B number.</p> <p>The MAP display indicates the range is 0 to 4; however, the system does not allow 0.</p>

AMCODE (continued)**Field descriptions for conditional datafill (Sheet 8 of 14)**

Field	Subfield or refinement	Entry	Explanation and action
	CLASS	ATT, CNTL, COLL, DATT, EMRG, IAGRP, ICNTL, INTL, IOPRA, LCL, NATL, OPRA, RURAL, SPEC, UNKW, or URBAN	<p>Translation CLASS. If the entry in subfield OSEL is CLASS, datafill this refinement. Enter the translation class determined by the dialed digits, as listed below. (This can be used for screening or billing purposes as described under CLASS in screening and charging options)</p> <ul style="list-style-type: none"> • ATT (attendant console) • CNTL (continental) • COLL (collect) • DATT (dial attendant) • EMRG (emergency) • IAGRP (interagent group) • ICNTL (intercontinental) • INTL (international) • IOPRA (international operator assisted) • LCL (local) • NATL (national) • OPRA (operator assisted) • RURAL (rural) • SPEC (special) • UNKW (unknown) • URBAN (urban)
	CLDFMT	CURRENT or POSTXLA	<p>Called format. If the entry in subfield OSEL is CAMA, enter either CURRENT or POSTXLA to produce the required ICAMA record format.</p> <p>If the entry is CURRENT, the system produces an ICAMA record with the signaled DN (without translation).</p> <p>If the entry is POSTXLA, the system produces an ICAMA record with a public switched telephone network (PSTN) number resulting from translations.</p>

AMCODE (continued)**Field descriptions for conditional datafill (Sheet 9 of 14)**

Field	Subfield or refinement	Entry	Explanation and action
	CLIOVRD	CNB, CNA	Calling line identity override. If the entry in subfield OSEL is CLIOVRD, enter data for this refinement. Enter CNA to allow the CLI for each call. Enter CNB to block the CLI for each call.
	CONDIGS	numeric (0 to 29 digits)	Consumed digits. If the entry in subfield OSEL is CONSUME, datafill this refinement. Enter a number to explicitly define the number of digits consumed during call processing.
	CONTINUE	CONT, NOCONT	Continue. If the entry in subfield OSEL is PRESEL, enter CONT to continue translations through UXLA. Enter NOCONT to immediately route translations through PCIXLA or PCITRK.
	CPMCALL	Y or N	Called party metering. If the entry in subfield OSEL is CPMCALL, datafill this refinement. Enter Y (yes) if calls are billed against the called party for intra-office calls. Enter N (no) for the default value of billing against the calling party for intraoffice calls.
	DDIDX	0 to 63 or DEFAULT	Destination discount index. If the entry in subfield OSEL is DDIDX, enter data for this refinement. Enter the destination discount index number, from table ACOPT.
	DEST	0 to 1023	Destination route list index. If the entry in subfield OSEL is DEST, datafill this refinement. Enter the number in the route list, of the same translation system, that the call is routed to.
	IAA_INDEX	0 to 1024	Interadministration accounting index. If the entry in subfield OSEL is IAA, datafill this refinement. Enter the value that indexes the corresponding tuple in IACTRL.

AMCODE (continued)**Field descriptions for conditional datafill (Sheet 10 of 14)**

Field	Subfield or refinement	Entry	Explanation and action
	LNET	alphanumeric (1 to 16 characters)	Logical network. If the entry in subfield OSEL is LNET, datafill this refinement. Enter the logical network name that the call is on. The logical network name must be previously datafilled in table LNETWORK. The entry in this field is used by the international metering system to determine a tariff for the call.
	MAX	0 to 30	Maximum digits. If the entry in subfield OSEL is MM, datafill this refinement. Enter the maximum number of digits expected. This value includes the digits used to index the current tuple and must also include the prefix digits specified in the current tuple.
	MIN	0 to 30	Minimum digits. If the entry in subfield OSEL is MM, datafill this refinement. Enter the minimum number of digits expected. This value includes the digits used to index the current tuple and must also include the prefix digits specified in the current tuple.
	MZONE	0 to 63	Metering zone. If the entry in subfield OSEL is MZONE, datafill this refinement. Enter the metering zone of the call, in the logical network as defined by selector LNET. The entry in this field is used by the international metering system to determine a tariff for the call.

AMCODE (continued)

Field descriptions for conditional datafill (Sheet 11 of 14)

Field	Subfield or refinement	Entry	Explanation and action
	NETSRV_ NAME	IPHS, DPHS, MOBILE, DA, TELEGRAM, or NCC	<p>Network service name. If the entry in subfield OSEL is NETSRV, datafill this refinement. The entry in this field determines the parameters in an outgoing IAM message.</p> <p>Enter IPHS to indicate a call to an independent personal handyphone system subscriber.</p> <p>Enter DPHS to indicate a call to a dependent personal handyphone system subscriber.</p> <p>Enter MOBILE to indicate a call to a mobile subscriber.</p> <p>Enter DA to indicate a call to the directory assistance operator.</p> <p>Enter TELEGRAM to indicate a call to the Telegram office.</p> <p>Enter NCC to indicate a call routed to one of the following networks:</p> <ul style="list-style-type: none"> • New Common Carrier serving international toll traffic • New Common Carrier serving national toll traffic
	NOA	INTL, LOCAL, NATL or NET	<p>Nature of address. Enter the required called party nature of address as follows:</p> <ul style="list-style-type: none"> • INTL (international) • LOCAL (local) • NATL (national) • NET (Intelligent Network Services)

AMCODE (continued)

Field descriptions for conditional datafill (Sheet 12 of 14)

Field	Subfield or refinement	Entry	Explanation and action
	ONNET	Y or N	<p>Call on virtual private network. If the entry in subfield OSEL is VPN, datafill this refinement. Enter Y if the call stays within the defined virtual private network. Otherwise, enter N.</p> <p>Overlapped outpulsing is only supported on off-network calls. Calls processed without subfield ONNET set to Y are off-network calls. Meridian Digital Centrex (MDC) calls are treated as off-network calls, and therefore overlapped outpulsing is supported for MDC calls.</p>
	PCCDR	0 to 9, B, C, D, E (1 to 3 digits)	<p>Pseudo country code digits. If the entry in subfield OSEL is PCC, datafill this refinement. Enter the three-digit pseudo country code (PCC). If a two-digit PCC is required, it must be padded by a leading zero.</p> <p>The pseudo country code is used to record a particular pseudo country code. This can be extracted for use by system logic later, for example, two-stage outpulsing.</p>
	PFDIGS	0 to 24	<p>Number of prefix digits. If the entry in subfield OSEL is PF, datafill this refinement. Enter the number of prefix digits. If prefix digits are identified in a previous table, this number is added to the existing value. Prefix digits are not used to index any further translation tables and are not outpulsed, but they do remain stored in call detail records (CDR).</p> <p>Note: If refinements PF and CONSUME are both datafilled for the same tuple, only the entry for the greater of the two values is processed; the other entry is ignored.</p>

AMCODE (continued)**Field descriptions for conditional datafill (Sheet 13 of 14)**

Field	Subfield or refinement	Entry	Explanation and action
	PFXAMA	0 to 4 digits, or N	Called party number prefix in AMA. If NOA is set to NTL, datafill PFXAMA with 0011. If NOA is set to NATL, datafill PFXAMA with 0. If NOA is set to LOCAL or NET, datafill PFXAMA with N.
	PRIVL	Y or N	Privileged user. If the entry in subfield OSEL is PRIVL, datafill this refinement. Enter Y (yes), if the user is a privileged user (for example, operator). Otherwise, enter N (no).
	SKIPDIGS	0 to 24	Skip digits. If the entry in subfield OSEL is EXTCIC, datafill this refinement. This field indicates how many digits to skip before extracting the carrier digits from the digit stream. This field operates on the B (called) number, so it is assumed that the CIC is signalled as part of the B number.
	SOURCE	PRESUB or DIALED	Carrier identification code source. If the entry in subfield OSEL is EXTCIC, datafill this refinement. This field specifies the source of the CIC as follows: <ul style="list-style-type: none"> • PRESUB - presubscribed, the CIC is defined in table TRKGRP • DIALED - dialed, the CIC is entered by the subscriber when dialing a call
	STOPRTMR	Y or N	Stop remote timer. Enter Y to disable the address complete message (ACM) timer of the remote switch. Default is N.
	XLAID	FREE, GENERIC1, GENERIC2, or GENERIC3	AMA translation identifier. If the entry in subfield OSEL is AMAXLAID, datafill this refinement. Enter the AMA translation identifier to be used against table AMAXLAID.

AMCODE (continued)

Field descriptions for conditional datafill (Sheet 14 of 14)

Field	Subfield or refinement	Entry	Explanation and action
	XLASYS	AC, AM, CT, FA, FT, NSC, OFC, PX	<p>Translation system. If the entry in subfield OSEL is XLT, datafill this refinement. Enter the next translation system to use, as listed below, followed by a space, then datafill refinement XLANAME:</p> <ul style="list-style-type: none"> • AC (access) • AM (ambiguous) • CT (country) • FA (foreign area) • FT (utility) • NSC (number service code) • OFC (office) • PX (prefix) <p>Note: NIL is not a valid entry. NIL is only used to satisfy internal software functionality. NSC is not used in GL03.</p>
	XLANAME	alphanumeric (1 to 8 characters)	<p>Translation name. If the entry in subfield OSEL is XLT, datafill this refinement. Enter the translation name of the table within the XLASYS to which the call is routed.</p>

AMCODE (continued)**XLASEL = DBQ**

If the entry in field XLASEL is DBQ, datafill the following refinements.

Field descriptions for conditional datafill (Sheet 1 of 2)

Field	Subfield or refinement	Entry	Explanation and action
	OPT	see subfield	Options. This field is a vector consisting of up to ten options. Each option consists of subfield OSEL, and refinements that depend on the entry in subfield OSEL. For each option, specify the option selector (OSEL), followed by a space, then the refinements, each separated by a space. The entry is concluded by a \$ and datafill continues with field DFOP.
	OSEL	MM, NSC, or PF	Option selector. The following options can be selected: Enter MM, followed by a space, and datafill refinements MIN and MAX, if the minimum and maximum dialed digits are known. Enter NSC, followed by a space, and datafill refinement NSCODE, if a number service code operation is to be performed on a call. Enter PF, followed by a space, and datafill refinement PFDIGS if there are prefix digits in the digit stream.
	MAX	0 to 30	Maximum digits. If the entry in subfield OSEL is MM, datafill this refinement. Enter the maximum number of digits expected. This value includes the digits used to index the current tuple and must also include the prefix digits specified in the current tuple.
	MIN	0 to 30	Minimum digits. If the entry in subfield OSEL is MM, datafill this refinement. Enter the minimum number of digits expected. This value includes the digits used to index the current tuple and must also include the prefix digits specified in the current tuple.

AMCODE (continued)**Field descriptions for conditional datafill (Sheet 2 of 2)**

Field	Subfield or refinement	Entry	Explanation and action
	NSCODE	AIN, 800P, E008, E800, MAP_HLR, MAP_MSC, MAP_VLR, PVN, MAPHLR, REPLDIGS, or VPN	<p>Number service code. If the entry in subfield OSEL is NSC, enter the required number service code for the operation to be performed on the call, as listed below:</p> <ul style="list-style-type: none"> • AIN (advanced intelligent network) • 800P (800+) • E008 (Enhanced 008) • E800 (Enhanced 800) • MAP_HLR (mobile application part home location register) • MAP_MSC (mobile application part mobile service switching center) • MAP_VLR (mobile application part visitor location register) • MAPHLR (appears only if feature AE1014 [MAP Interworking to BTUP] is on the switch) • PVN (private virtual network) • REPLDIGS (replace digits) • VPN (virtual private network)
	PFDIGS	0 to 24	<p>Number of prefix digits. If the entry in subfield OSEL is PF, datafill this refinement. Enter the number of prefix digits. If prefix digits are identified in a previous table, then this number is added to the existing value. Prefix digits are not used to index any further translation tables and are not outputted, but they do remain stored in call detail records (CDR).</p>

AMCODE (continued)**XLASEL = DMOD**

If the entry in subfield XLASEL is DMOD, datafill the following refinements.

Field descriptions for conditional datafill (Sheet 1 of 7)

Field	Subfield or refinement	Entry	Explanation and action
	OPT	see subfield	Options. This field is a vector consisting of up to ten options. Each option consists of subfield OSEL, and refinements that depend on the entry in subfield OSEL. For each option, specify the option selector (OSEL), followed by a space, and the refinements, each separated by a space. The entry is concluded by a \$ and datafill continues with field DFOP.
	OSEL	AFTER, CDNRTE, CGNDM, CONSUME, COODM, CPCRTE, DEL, EXTCIC, INSRT, PF, RBP, REPL, SETCDN, VPNREPL, VPNXLT, or XLT	<p>The following options can be selected:</p> <p>Enter AFTER, followed by a space, and datafill refinement AFTER if a certain number of digits must be skipped before modifying the digit stream.</p> <p>Enter CDNRTE to route the call using the called number name (CDNNAME) from table CDNCHAR. If the CDNNAME is present on the incoming call, or is set by the SETCDN option, translation proceeds to table CDNUXLA. The CDNRTE option does not have refinements.</p> <p>Enter CGNDM, followed by a space, and datafill refinements PREFXCLI and INSRTCLI to remove digits from the calling line identification (CLI) and insert a datafilled digit string of up to five digits in the prefix string. The total length of the CLI and the digit string can be up to 18 digits. A modified CLI and digit string greater than 18 digits routes the call to treatment.</p> <p>Enter CONSUME, followed by a space, and datafill refinement CONDIGS to specify the number of digits that are consumed during translation.</p>

AMCODE (continued)

Field descriptions for conditional datafill (Sheet 2 of 7)

Field	Subfield or refinement	Entry	Explanation and action
			<p>Enter COODM, followed by a space, and datafill refinement SERVICE to replace the dialed emergency code by the emergency number stored in table LAC.</p> <p>Note: Option selector COODM must be combined with option XLT to guarantee that translation continues with the modified number. Selector COODM cannot be combined with any other option.</p> <p>Enter DEL, followed by a space, and datafill refinement DELDIGS. Further digits are accepted from the agent, and overlapped outpulsing is not affected. Digits being deleted are processed before those being inserted.</p> <p>Enter EXTCIC, followed by a space, and datafill refinements SOURCE, SKIPDIGS, and CICSIZE. EXTCIC is the external carrier identification code that indicates a long distance carrier in the global environment. This option is only supported for TOPS calls. For further information, refer to functionality Global Competitive Access, GOS00006.</p> <p>Enter INSRT, followed by a space, and datafill refinement INSRDIGS. Further digits are accepted from the agent, and overlapped outpulsing is not affected. Digits being deleted are processed before those being inserted.</p> <p>Note: Digit insertion is done in the actual digit stream, and the changes are reflected in call detail records. Replacement and insertion cannot be datafilled in the same tuple. If both options are datafilled, the second option in the tuple is used.</p> <p>Enter PF, followed by a space, and datafill refinement PFDIGS, if there are prefix digits in the digit stream.</p>

AMCODE (continued)

Field descriptions for conditional datafill (Sheet 3 of 7)

Field	Subfield or refinement	Entry	Explanation and action
			<p>Enter RBP without refinements. The entry RBP is used when a call is to be marked as Ringback Price. The RBP entry in table ACCODE suffixes a hexadecimal E to the calling digits for a call that translates using a tuple with option RBP.</p> <p>Enter REPL and datafill refinement REPLDIGS. Overlapped outpulsing is disabled, and all digits are collected before continuing.</p> <p>Note: Digit replacement occurs in the actual digit stream, and the changes are reflected in call detail records. Replacement and insertion cannot be datafilled in the same tuple. If both options are datafilled, the second option in the tuple is used.</p> <p>Enter SETCDN, followed by a space, and enter data for refinement CDNNAME. The SETCDN option allows CDN routing when incoming agents are not available in table CDNCHAR.</p> <p>Enter VPNREPL to replace the called party digits with the VPN called party digits conveyed across the public network by the QSIG Feature Transparency mechanism.</p> <p>Enter VPNXLT to replace the current translation system and translator name with the values stored in table BGIDMAP. The entry to table BGIDMAP is addressed by the NNI BGID and SIGNIFICANCE information received in the originating signaling for the call.</p> <p>Enter XLT, followed by a space, and datafill refinement XLASYS if the call proceeds to another translation system.</p>

AMCODE (continued)

Field descriptions for conditional datafill (Sheet 4 of 7)

Field	Subfield or refinement	Entry	Explanation and action
	AFTER	0 to 29	<p>After. If the entry in subfield OSEL is AFTER, datafill this refinement. Enter the number of digits to skip before doing the modification. The default case is to calculate the new prefix fence, and replace, insert, or delete digits after the fence (for example, starting at the next digit). Option AFTER is an additional number of digits to skip before doing the modification. Option AFTER refers to the option datafilled immediately before it. For example,</p> <p>>DMOD DEL 3 AFTER 2 INSRT 11</p> <p>skips two digits, deletes the next three, and inserts digit 11 at the beginning of the digit string. The result when applied to 234567 is 23117.</p> <p>Note: Datafilling this refinement with 0 (the default value), displays the following error message:</p> <pre>Too few digits for AFTER UNSUPPORTED OPTION AT: # PROCESSING ERROR UNEXPECTED ERROR CONDITION</pre>
	CDNNAME	alphanumeric string	<p>Called number name. If the entry in subfield OSEL is SETCDN, enter data for this refinement. The CDNNAME refinement allows CDN routing when incoming agents are not available in table CDNCHAR.</p>
	CICSIZE	1 to 4	<p>CIC size. If the entry in subfield OSEL is EXTCIC, datafill this refinement. This field indicates how many digits are in the CIC. This field operates on the B (called) number, so it is assumed that the CIC is signalled as part of the B number.</p> <p>The MAP display indicates the range is 0 to 4; however, the system does not allow 0.</p>

AMCODE (continued)**Field descriptions for conditional datafill (Sheet 5 of 7)**

Field	Subfield or refinement	Entry	Explanation and action
	CONDIGS	0 to 29	Consumed digits. If the entry in subfield OSEL is CONSUME, datafill this refinement. Enter a number to explicitly define the number of digits consumed during call processing.
	DELDIGS	0 to 29	Delete digits. If the entry in subfield OSEL is DEL, datafill this refinement. Enter the number of digits to be deleted, after skipping digits to be left unprocessed.
	INSRDIGS	numeric (0 to 29 digits)	Insert digits. If the entry in subfield OSEL is INSRT, datafill this refinement. Enter the digits to be inserted, after skipping digits to be left unprocessed.
	INSRTCLI	1 to 5 digits or \$	Insert calling line identification. If the entry in subfield OSEL is CGNDM, datafill this refinement. Enter the new string to insert as the prefix onto the CLI. Enter \$ to specify that no digit string is inserted.
	PFDIGS	0 to 24	Number of prefix digits. If the entry in subfield OSEL is PF, datafill this refinement. Enter the number of prefix digits. If prefix digits are identified in a previous table, this number is added to the existing value. Prefix digits are not used to index any further translation tables and are not outputted, but they do remain stored in call detail records (CDR). Note: If refinements PF and CONSUME are both datafilled for the same tuple, only the entry for the greater of the two values is processed; the other entry is ignored.
	PREFXCLI	0 to 18	Prefix calling line identification. If the entry in subfield OSEL is CGNDM, datafill this refinement. Enter the number of prefix digits to delete.
	REPLDIGS	numeric (0 to 30 digits)	Replace digits. If the entry in subfield OSEL is REPL, datafill this refinement. Enter the digits that replace the existing digits, after skipping digits to be left unprocessed.

AMCODE (continued)**Field descriptions for conditional datafill (Sheet 6 of 7)**

Field	Subfield or refinement	Entry	Explanation and action
	SERVICE	alphanumeric (1 to 8 characters)	COODM service. If the entry in subfield OSEL is COODM, datafill this refinement. Enter the emergency service name. Emergency service names are listed in field EMRGSERV in table LAC.
	SKIPDIGS	0 to 24	Skip digits. If the entry in subfield OSEL is EXTCIC, datafill this refinement. This field indicates how many digits to skip before extracting the carrier digits from the digit stream. This field operates on the B (called) number, so it is assumed that the CIC is signalled as part of the B number.
	SOURCE	PRESUB or DIALED	Carrier identification code source. If the entry in subfield OSEL is EXTCIC, datafill this refinement. This field specifies the source of the CIC as follows: <ul style="list-style-type: none"> • PRESUB - presubscribed, the CIC is defined in table TRKGRP • DIALED - dialed, the CIC is entered by the subscriber when dialing a call

AMCODE (continued)

Field descriptions for conditional datafill (Sheet 7 of 7)

Field	Subfield or refinement	Entry	Explanation and action
	XLASYS	AC, AM, CT, FA, FT, NSC, OFC, or PX	<p>Translation system. If the entry in subfield OSEL is XLT, datafill this refinement. Enter the next translation system to use, followed by a space, and datafill subfield XLANAME (the instance of the translation system).</p> <p>The choice of translation systems is as follows:</p> <ul style="list-style-type: none"> • AC (access) • AM (ambiguous) • CT (country) • FA (foreign area) • FT (utility) • NSC (number service code) • OFC (office) • PX (prefix) <p>Note: NSC is not used in GL03. NIL is not a valid entry. NIL is only used to satisfy internal software functionality.</p>
	XLANAME	alphanumeric (1 to 8 characters)	<p>Translation name. If the entry in subfield OSEL is XLT, datafill this refinement. Enter the translation name of the table within the XLASYS to which the call is routed.</p>

XLASEL = DNRTE

After datafilling table ACHEAD, table DNINV must be datafilled before selector DNRTE is datafilled in table ACCODE.

AMCODE (continued)

Table AMAXLAID must be datafilled prior to selecting option AMAXLAID in field OSEL.

Field descriptions for conditional datafill (Sheet 1 of 4)

Field	Subfield or refinement	Entry	Explanation and action
	OPT	see subfield	Options. This field is a vector consisting of up to ten options. Each option consists of subfield OSEL, and refinements that depend on the entry in subfield OSEL. For each option, specify the option selector (OSEL), followed by a space, and the refinements, each separated by a space. The entry is concluded by a \$ and datafill continues with field DFOP.
	OSEL	ALLOWOVLP AMAXLAID, CAMA, CLASS, DN, MM, PF, or SF	Option selector. The following options can be selected: Enter ALLOWOVLP to allow overlap. Enter AMAXLAID, followed by a space, and datafill refinement XLAID to specify an automatic message accounting (AMA) identity from within table AMAXLAID. Enter CAMA, followed by a space, and datafill refinement CLDFMT. The entry in CLDFMT indicates whether the international centralized AMA (ICAMA) record is generated with the originally signaled DN or the final public switched telephone network (PSTN) number.

AMCODE (continued)

Field descriptions for conditional datafill (Sheet 3 of 4)

Field	Subfield or refinement	Entry	Explanation and action
	CLASS	ATT, CNTL, COLL DATT, EMRG, IAGRP, ICNTL, INTL, IOPRA, LCL, NATL, OPRA, RURAL, SPEC, UNKW, or URBAN	<p>Translation class. If the entry in subfield OSEL is CLASS, datafill this refinement. Enter the translation class determined by the dialed digits. This can be used for screening or billing purposes as described under CLASS in screening and charging options.</p> <ul style="list-style-type: none"> • ATT (attendant console) • CNTL (continental) • COLL (collect) • DATT (dial attendant) • EMRG (emergency) • IAGRP (interagent group) • ICNTL (intercontinental) • INTL (international) • IOPRA (international operator assisted) • LCL (local) • NATL (national) • OPRA (operator assisted) • RURAL (rural) • SPEC (special) • UNKW (unknown) • URBAN (urban)
	MAX	0 to 30	<p>Maximum digits. If the entry in subfield OSEL is MM, datafill this refinement. Enter the maximum number of digits expected. This value includes the digits used to index the current tuple and must also include the prefix digits specified in the current tuple.</p>
	MIN	0 to 30	<p>Minimum digits. If the entry in subfield OSEL is MM, datafill this refinement. Enter the minimum number of digits expected. This value includes the digits used to index the current tuple and must also include the prefix digits specified in the current tuple.</p>

AMCODE (continued)**Field descriptions for conditional datafill (Sheet 4 of 4)**

Field	Subfield or refinement	Entry	Explanation and action
	OFC	numeric (1 to 7 digits)	Seven-digit office code. If the entry in subfield OSEL is DN, enter the office code for the DN that the call is routed to.
	PFDIGS	0 to 24	Number of prefix digits. If the entry in subfield OSEL is PF, datafill this refinement. Enter the number of prefix digits. If prefix digits are identified in a previous table, this number is added to the existing value. Prefix digits are not used to index any further translation tables and are not outpulsed, but they do remain stored in call detail records (CDR).
	SFDIGS	0 to 29	Station fence digits. If the entry in subfield OSEL is SF, datafill this refinement. Enter a number to indicate how many digits to advance past the start of the digits that index into the tuple. If option SF is not datafilled, the last four digits comprise the station code. During call processing, the station code digits consist of all digits beyond this indicator to the end of the dialled digits.
	SNPA	000 to 999 (3 digits)	Serving number plan area. If the entry in subfield OSEL is DN, enter the required serving number plan area (SNPA). This number must be datafilled in table HNPACONT or in table SNPANAME.
	XLAIID	FREE, GENERIC1, GENERIC2, or GENERIC3	AMA translation identifier. If the entry in subfield OSEL is AMAXLAID, enter the AMA translation identifier to be used against table AMAXLAID.

AMCODE (continued)**XLASEL = FEAT**

If the entry in field XLASEL is FEAT, datafill the following refinements.

Field descriptions for conditional datafill (Sheet 1 of 3)

Field	Subfield or refinement	Entry	Explanation and action
	OPT	see subfield	Options. This field is a vector consisting of up to ten options. Each option consists of subfield OSEL, and refinements that depend on the entry in subfield OSEL. For each option, specify the option selector (OSEL), followed by a space, and the refinements, each separated by a space. The entry is concluded by a \$ and datafill continues with field DFOP.
	OSEL	FTR, FUNC, MM, or PF	<p>Option selector. The following options can be selected:</p> <p>Enter FTR, followed by a space, and datafill refinement FTR to identify the international line feature.</p> <p>Enter FUNC, followed by a space, and datafill refinement FUNC to identify the international line feature function.</p> <p>Enter MM, followed by a space, and datafill refinements MIN and MAX if the minimum and maximum dialed digits are known.</p> <p>Enter PF, followed by a space, and datafill refinement PFDIGS if there are prefix digits in the digit stream.</p>

AMCODE (continued)**Field descriptions for conditional datafill (Sheet 2 of 3)**

Field	Subfield or refinement	Entry	Explanation and action
	FTR	CALLBACK, CALLCHAR, CLCTDIGS, JES, NTC, TLC, VMWI, VSC or VALIDATE	<p>Feature name. If the entry in subfield OSEL is FTR, enter the refinement name shown below:</p> <ul style="list-style-type: none"> • CALLBACK (call back) • CALLCHAR (call characters) • CLCTDIGS (collect digits) • JES (Japan emergency services) • NTC (Notify Time Charges) • TLC (trunk logic circuit) • VMWI (voice mail waiting indication) • VSC (vertical service code) • VALIDATE (not used in GL03)
	FUNC	ACT, DEACT, DELETE, INTER, PROG, or USAGE	<p>Feature function code. If subfield OSEL is set to FUNC, enter one of the international line feature function codes listed below:</p> <ul style="list-style-type: none"> • ACT (activate) • DEACT (deactive) • DELETE (delete) • INTER (interrogate) • PROG (programming) • USAGE (usage)
	MAX	0 to 30	<p>Maximum digits. If the entry in subfield OSEL is MM, datafill this refinement. Enter the maximum number of digits expected following MIN entry and a space. This value includes the digits used to index the current tuple and must also include the prefix digits specified in the current tuple.</p>

AMCODE (continued)**Field descriptions for conditional datafill (Sheet 3 of 3)**

Field	Subfield or refinement	Entry	Explanation and action
	MIN	0 to 30	Minimum digits. If the entry in subfield OSEL is MM, datafill this refinement. Enter the minimum number of digits expected. This value includes the digits used to index the current tuple and must also include the prefix digits specified in the current tuple.
	PFDIGS	0 to 24	Number of prefix digits. If the entry in subfield OSEL is PF, datafill this refinement. Enter the number of prefix digits. If prefix digits are identified in a previous table, this number is added to the existing value. Prefix digits are not used to index any further translation tables and are not outpulsed, but they remain stored in call detail records (CDR).

XLASEL = FEATINFO

If the entry in subfield XLASEL is FEATINFO, datafill the following refinements. Selector FEATINFO makes use of table DNSCRN to store information against DNs, which is used during call processing to determine how to proceed with the call. The screening function is triggered by selector FEATINFO in the universal translation tables. The options available with this selector are shown below.

Field descriptions for conditional datafill (Sheet 1 of 10)

Field	Subfield or refinement	Entry	Explanation and action
	FTR	CALLBACK, CALLCHAR, CLCTDIGS, JES, NTC, TLC, or VALIDATE	Feature name. Enter CALLBACK to enable originator callback during translations. Datafill subfield CALLBACK_OPTION and its refinements, then datafill subfields PFDIGS, MINDIGS, MAXDIGS, and TABREF. Enter CALLCHAR to modify all signaling characteristics. Datafill subfields CLLCHROP, PFDIGS, MINDIGS, MAXDIGS, and TABREF.

AMCODE (continued)

Field descriptions for conditional datafill (Sheet 2 of 10)

Field	Subfield or refinement	Entry	Explanation and action
			<p>Enter CLCTDIGS to collect digits from the call originator and add them to the called digits stream for translation. Datafill subfields CLDGMIN, CLDGMAX, CLCTDIGS_OPTION, PFDIGS, MINDIGS, MAXDIGS, and TABREF.</p> <p>Enter JES to activate the Japan Emergency Service feature. Datafill refinements PFDIGS and TABREF.</p> <p>Enter NTC to notify the originating subscriber of applicable time and charges after the call terminates. Datafill subfield SUBOPT_NAME and its refinement, then datafill subfields PFDIGS, MINDIGS, MAXDIGS, and TABREF.</p> <p>Enter TLC to enable the test line call feature, which provides audible ringback tone followed by dial tone after specified durations. Datafill subfields RING_BACK_TONE_DUR, DIAL_TONE_DUR, TLC_PREFIX_DIGS, TLC_NUM_DIGS, and TLC_CHARGE.</p> <p>Enter VALIDATE, and datafill subfield VALDATOP and its refinements. Datafill subfields PFDIGS, MINDIGS, MAXDIGS, and TABREF.</p>
	CALLBACK_OPTION	CLCTDEST or NIL	<p>Callback option. If the entry in field FTR is CALLBACK, datafill this option. Enter CLCTDEST to call back the subscriber and collect destination digits. Datafill subfields CLDGMIN, CLDGMAX, DISC_ANNC_TRK, PROMPT_ANNC_TRK, and SEND_ANM. Otherwise, enter NIL.</p>
	CLDGMIN	1 to 24	<p>Minimum collected digits. Enter the minimum number of digits to be collected and entered into the called digit stream.</p>

AMCODE (continued)**Field descriptions for conditional datafill (Sheet 3 of 10)**

Field	Subfield or refinement	Entry	Explanation and action
	CLDGMAX	1 to 24	Maximum collected digits. Enter maximum number of digits to be collected and written into the called digit stream. The value cannot be less than CLDGMIN.
	DISC_ANNC_TRK	alphanumeric (1 to 16 characters)	Disconnect announcement trunk. Enter trunk common language location identifier (CLLI).
	PROMPT_ANNC_TRK	alphanumeric (1 to 16 characters)	Prompt announcement trunk. Enter trunk the common language location identifier (CLLI).
	SEND_ANM	Y or N	Send answer message. Enter Y (yes) or N (no).
	CLLCHROP	NOCHGMSG or EARLYCPG	Call characteristics. If the entry in field FTR is CALLCHAR, datafill this option. Enter NOCHGMSG to block backward CHG message. Enter EARLYCPG to specify that a call progress (CPG) message is issued in the backwards direction before an address complete message (ACM) is sent. The CPG message is permitted before an ACM in certain ISDN user part (ISUP) variants to establish a bidirectional speech path and to stop the T7 timer.
	CLCTDIGS_OPTION	NIL or \$	Collect digits option. If the entry in field FTR is CLCTDIGS, datafill this option. Enter NIL or enter \$ to proceed to the next option.
	SUBOPT_NAME	DUR_ADJ	Suboption name. If the entry in field FTR is NTC, datafill this option. Enter DUR_ADJ to specify the duration adjustment for NTC and datafill subfield DURATION_ADJ.
	DURATION_ADJ	0 to 99	Duration adjustment. Enter the time in seconds.

AMCODE (continued)**Field descriptions for conditional datafill (Sheet 4 of 10)**

Field	Subfield or refinement	Entry	Explanation and action
	RING_BACK_TONE_DUR	1 to 255	Ringback tone duration. If the entry in field FTR is TLC, datafill this option. Enter the time, in seconds, that ringback tone is provided to the originator.
	DIAL_TONE_DUR	1 to 255	Dial tone duration. If the entry in field FTR is TLC, datafill this option. Enter the time, in seconds, that dial tone is provided to the originator.
	TLC_PREFIX_DIGS	0 to 18	Prefix digits in called number. If the entry in field FTR is TLC, datafill this option. Enter the number of digits to advance the prefix fence to detect the charge message digits when CPC = PAYPHONE.
	TLC_NUM_DIGS	numeric (3 or 4) Japan only	Test line call number of digits. Enter the number of dialed digits to be transferred to the NCCI#7 CHG message. This is also the number of digits stored in the LMNNUM field of the SMDR #DE record.
	TLC_CHARGE	Y or N	Test line call charge indicator. The TLC_CHARGE field indicates the billing status of an ISUP test call. Enter Y if the call is billable. Enter N if the call is not billable. The default value for this field is N.
	OPT	see subfield VALDATOP	Options. If the entry in field FTR is VALIDATE, datafill this option. This field is a vector consisting of up to five options. Each option consists of subfield VALDATOP, and refinements that depend on the entry in subfield VALDATOP. For each option, specify VALDATOP, followed by a space, then the refinements, each separated by a space. The entry is concluded by a \$ and datafill continues with field DFOP.

AMCODE (continued)**Field descriptions for conditional datafill (Sheet 5 of 10)**

Field	Subfield or refinement	Entry	Explanation and action
	VALDATOP	BCSCRN, CALLED, CLDTCOLG, CLISERV, CUSTMOD, LCASCRN, NOCHARGE, PRESEL, SCRNLNTH, SUBSCRN, TCNOTSCR, THIRDPTY, VERDEST, V3PTYBIL	<p>Validate option. Enter a list of up to five options. The options specify what characteristics are to be considered when screening the call. Enter \$ to signify the end of the list.</p> <p>Note: Selector VALIDATE is traversed only once for each call.</p> <p>Enter BCSCRN and datafill refinement BCOPTS to identify the bearer capability name.</p> <p>Enter CALLED to indicate the number to be used for screening. The SUBSCRN options are used to specify the subscriber types allowed to receive the call.</p> <p>Note: When using option CALLED, there must be no further digit manipulation after selector VALIDATE is encountered in translations.</p> <p>If option CALLED is not entered, then the calling party number is used for screening and the SUBSCRN options are used to specify the subscriber types allowed to make the call.</p> <p>Note: Pay phone subscribers are treated as general subscribers if option CALLED is specified.</p> <p>Enter CLDTCOLG, followed by a space, to copy digits from the called to the calling digit stream, and datafill options OFFSET and COUNT.</p> <p>Enter CLISERV, followed by a space, and enter data in subfield SERVNAME to add the name of the service provider.</p>

AMCODE (continued)

Field descriptions for conditional datafill (Sheet 6 of 10)

Field	Subfield or refinement	Entry	Explanation and action
			<p>Enter CUSTMOD, followed by a space, to alter the internal network class of service (NCOS) and customer group to new value for a given directory number (DN) based on the CUSTINFO attribute in table DNSCRN. The source of the DN used as an index into table DNSCRN is determined by the VALIDATE datafill. Datafill refinement CUSTSCRN.</p> <p>Enter LCASCRN, followed by a space, to enable local calling area screening. The called and calling numbers are checked against tables LCARNAME and LCASCRCN to determine if the numbers are local to each other, and whether the call should be denied or allowed to continue routing.</p> <p>Enter NOCHARGE, followed by a space, to indicate that the call is nonbillable.</p> <p>Note: If both NOCHARGE and THIRDPPTY options are specified, NOCHARGE takes precedence.</p> <p>Enter PRESEL to allow screening for the PRESEL attribute in table DNSCRN.</p> <p>Enter SCRNLNTH, followed by a space, and datafill refinement MINLNGTH to specify the minimum length of the number being screened.</p> <p>Enter SUBSCRN, followed by a space, and datafill up to three multiples of the following subscriber types: GENERAL, PAYPHONE, PERSONAL, and MOBILE. Enter \$ after entering SUBSCRN to indicate that no subscriber types are permitted to make or receive the call.</p> <p>Enter TCNOTSCR to indicate that calls with CPC set to Test Call are not screened.</p>

AMCODE (continued)

Field descriptions for conditional datafill (Sheet 7 of 10)

Field	Subfield or refinement	Entry	Explanation and action
			<p>Enter THIRDPY to indicate that automatic third party billing is used. Table DNSCRN is checked for attribute UNPAID.</p> <p>Note: If both NOCHARGE and THIRDPY options are specified, NOCHARGE takes precedence.</p> <p>Note: Payphone subscribers are treated as general subscribers if option CALLED is specified.</p> <p>Enter VERDEST to verify the destination of a call. Called digits are checked against ADDCODE entries in table DNSCRN.</p> <p>Note: NIL appears on the switch range but is not a valid entry. The value NIL is used only to satisfy internal software requirements.</p>
	BCOPTS	alphanumeric (1 to 8 characters)	Bearer capability option. If the entry in field VALDATOP is CLDTCGLG, enter subfield count to count the digits from the called stream to the calling stream.
	COUNT	0 to 30	If the entry in field VALDATOP is BCSCRN, enter data for this refinement. Enter a maximum of four bearer capability names.
	CUSTSCRN	Y or N	<p>Customer screen. Enter Y to block calls that are not subscribed to the switched on-net services if attempting a switched on-net call. If the DN being screened is not present in table DNSCRN, the call is rejected with the Call Not Allowed (CNAD) treatment. The internal NCOS and CUSTGRP associated with the call are altered to the values found in the CUSTINFO attribute if present for the given DN in table DNSCRN. The DN used to index table DNSCRN can be the subscriber calling line identification (CLI) or the dialed number. The source of the DN is determined by the datafill of field VALIDATE.</p> <p>Enter N if no screening is performed.</p>

AMCODE (continued)**Field descriptions for conditional datafill (Sheet 8 of 10)**

Field	Subfield or refinement	Entry	Explanation and action
Note: The FEATINFO values CCANN, CCARD, CCSDT, DAFOP, FAXSUP, FAXTEST, INBFAX, INBFD, INTLFD, ISD, ISDTST, ISDVRE, OUTBFAX, OUTBFD, PB3RDPTY, PBCALL, PBISD, PBISDVRE, and PBTST are valid only in DMS-250 switching offices. Additional DMS-250 parameters are listed in the DMS-250 specific data schema NTPs.			
	MINLNGTH	0 to 18 values from 0 to 30 are possible in APC software loads	Minimum length. If the entry in field VALDATOP is SCRNLNTH, enter the minimum number of digits required in number being screened.
	OFFSET	0 to 30	If the entry in field VALDATOP is CLDTCOLG, enter data in subfield OFFSET to offset the digits from the called stream to the calling stream.
	SERVNAME	alphanumeric string	Service provider name. If the entry in field VALDATOP is CLISERV, enter the name of the service provider in this refinement.
	SUBSCTYP	GENERAL, PAYPHONE, PERSONAL, or MOBILE	Subscriber type. Enter subscriber type, followed by a space, and datafill refinements WHITLIST, CHKBLKCL, CHKUNPD, and CHKCCR. This option allows you to specify which subscriber types are permitted to make or receive a call and whether the subscriber's standing is important for a call.
	WHITLIST	Y or N	Whether it list. Enter Y (yes) to indicate that the subscriber's directory number must be datafilled in table DNSCRN. Otherwise, enter N (no).
	CHKBLKCL	Y or N	Check block call. Enter Y to check if the subscriber has subscribed to all services for which this tuple is being used (BLKCALL attribute in table DNSCRN). Otherwise, enter N.
	CHKUNPD	Y or N	Check unpaid. Enter Y to check if the subscriber has paid his bills. Otherwise, enter N.

AMCODE (continued)**Field descriptions for conditional datafill (Sheet 9 of 10)**

Field	Subfield or refinement	Entry	Explanation and action
	CHKCCR	Y or N	Check cumulative call restriction. Enter Y to check the subscriber's cumulative charge limit. Otherwise, enter N.
	PFDIGS	0 to 24	Prefix digits. Enter the number of prefix digits present at this point in the call. Prefix digits are not used to index any further translation tables and are not outpulsed, but they remain stored in call detail records (CDR).
	MINDIGS	0 to 30	Minimum digits. Enter the minimum number of digits expected. This value includes the digits used to index the current tuple and must also include the prefix digits specified in the current tuple.
	MAXDIGS	0 to 30	Maximum digits. Enter the maximum number of digits expected. This value includes the digits used to index the current tuple and must also include the prefix digits specified in the current tuple.
	TABREF	see subfields	Table reference. This field consists of subfields XLASYS and XLANAME.

AMCODE (continued)**Field descriptions for conditional datafill (Sheet 10 of 10)**

Field	Subfield or refinement	Entry	Explanation and action
	XLASYS	AC, AM, CT, FA, FT, NSC, OFC, or PX	<p>Translation system. Enter the next translation system to use, followed by a space, and datafill subfield XLANAME (the instance of the translation system).</p> <p>The choice of translation systems is as follows:</p> <ul style="list-style-type: none"> • AC (access) • AM (ambiguous) • CT (country) • FA (foreign area) • FT (utility) • NSC (number service code) • OFC (office) • PX (prefix) <p>Note: NIL is not a valid entry. NIL is used only to satisfy internal software functionality.</p>
	XLANAME	alphanumeric (1 to 8 characters)	Translation name. Enter the translation name of the table instance within the XLASYS to which the call is routed.

XLASEL = HRC

If the entry in subfield XLASEL is HRC, datafill the following refinements.

Field descriptions for conditional datafill (Sheet 1 of 2)

Field	Subfield	Entry	Explanation and action
	OPT	see subfield	Options. This field contains subfield OSEL, and refinements that depend on the entry in subfield OSEL. The entry is concluded by a \$ and datafill continues with field DFOP.
	OSEL	XLT, PFBILL	Option selector. If the call proceeds to another translation system, enter XLT, followed by a space, and datafill refinement XLASYS. Also complete an entry for option selector PFBILL.

AMCODE (continued)**Field descriptions for conditional datafill (Sheet 2 of 2)**

Field	Subfield	Entry	Explanation and action
	XLASYS	AC, AM, CT, FA, FT, NSC, OFC, PX	<p>Translation system. If option selector XLT is entered in subfield OSEL, datafill this refinement. Enter the next translation system to use, followed by a space, then datafill refinement XLANAME. Enter one of the following:</p> <ul style="list-style-type: none"> • AC (access) • AM (ambiguous) • CT (country) • FA (foreign area) • FT (utility) • NSC (number service code) • OFC (office) • PX (prefix) <p>Note: NIL is not a valid entry. NIL is used only to satisfy internal software functionality. NSC is not used in GL03.</p>
	XLANAME	alphanumeric (1 to 8 characters)	Translation name. If XLT is entered in subfield OSEL, datafill this refinement. Enter the translation name of the table within the XLASYS to which the call is routed.
	PFBILL	Y or N	Prefix billing option. Enter PFBILL, followed by a space, and then enter either Y or N. If Y is entered, the home routing code specified in the tuple is included in the billing record. If N is entered, the home routing code is not included in billing records.

AMCODE (continued)**XLASEL = IAC**

If the entry in subfield XLASEL is IAC, datafill the following refinements.

Field descriptions for conditional datafill

Field	Subfield or refinement	Entry	Explanation and action
	OPT	see subfield	Options. This field is a vector list consisting of up to ten options. Each option consists of subfield OSEL, and refinements that depend on the entry in subfield OSEL. The entry is concluded by a \$ and datafill continues with field DFOP.
	OSEL	PF	Option selector. Enter PF, followed by a space, and datafill refinement PFDIGS, if there are prefix digits in the digit stream.
	PFDIGS	0 to 24	Number of prefix digits. If the entry in subfield OSEL is PF, datafill this refinement. Enter the number of prefix digits. If prefix digits are identified in a previous table, then this number is added to the existing value. Prefix digits are not used to index any further translation tables and are not outpulsed, but they remain stored in call detail records (CDR).

XLASEL = RTE

If the entry in subfield XLASEL is RTE, datafill the following refinements.

AMCODE (continued)

Table AMAXLAID must be datafilled prior to selecting option AMAXLAID in field OSEL.

Field descriptions for conditional datafill (Sheet 1 of 13)

Field	Subfield or refinement	Entry	Explanation and action
	OPT	see subfield	Options. This field is a vector consisting of up to ten options. Each option consists of subfield OSEL, and refinements that depend on the entry in subfield OSEL. For each option, specify the option selector (OSEL), followed by a space, and the refinements, each separated by a space. The entry is concluded by a \$ and datafill continues with field DFOP.
	OSEL	ACF, AMAXLAID, BLKOVLP, CALLCTRL, CAMA, CDN, CDNRTE, CLASS, CONSUME, CPCRTE, CPMCALL, DDIDX, DEST, EXTCIC, IAA, LNET, MM, MZONE, NETSRV, PCC, PF, PIP, PNRF, PRESEL, PRESELRTE, PRIVL, SETCDN, TELETAXE, TOC, or VPN	<p>Option selector. The following options can be selected:</p> <p>Enter ACF, followed by a space, and datafill refinement ACF, if the area code fence is defined.</p> <p>Enter AMAXLAID, followed by a space, and datafill refinement XLAID, to specify an automatic message accounting (AMA) identity from within table AMAXLAID.</p> <p>Enter BLKOVLP to prevent the system from outpulsing calls until all CDN digits are collected. The BLKOVLP option does not have refinements.</p> <p>Enter CALLCTRL, followed by a space, and datafill refinement CALLCTRL. The entry in refinement CALLCTRL indicates who has control of the call: the calling party, the called party, or both.</p> <p>Enter CAMA, followed by a space, and datafill refinement CLDFMT. The entry in refinement CLDFMT indicates whether the international centralized automatic message accounting (ICAMA) record is generated with either the originally signaled directory number (DN) or the final public switched telephone network (PSTN) number.</p>

AMCODE (continued)**Field descriptions for conditional datafill (Sheet 2 of 13)**

Field	Subfield or refinement	Entry	Explanation and action
			<p>Enter CDN, followed by a space, and datafill refinement CDN to select the nature of address field. This field is used to identify the called party of the initial address message (IAM). It is used for Australian ISDN user part (AISUP) call translations.</p> <p>Enter CDNRTE to route a call using the called number name (CDNNAME) from table CDNCHAR. If the CDNNAME is present on the incoming call or is set by the SETCDN option, translation proceeds to table CDNUXLA. The CDNRTE option does not have refinements.</p> <p>Enter CLASS, followed by a space, and datafill refinement CLASS, if the class of the dialed digits is determined.</p> <p>Enter CONSUME, followed by a space, and datafill refinement CONDIGS, to specify the number of digits that are consumed during translation.</p> <p>Enter CPCRTE to route a call using the calling party category (CPCNAME) from table CDNCHAR. If the CPCNAME is present on the incoming call, translation proceeds to table CPCUXLA. The CPCRTE option does not have refinements.</p> <p>Enter CPMCALL, followed by a space, and datafill refinement CPMCALL, to specify call billing against the called party instead of the calling party for intraoffice calls.</p> <p>Enter DDIDX, followed by a space, and enter data for refinement DDIDX if a destination discount applies.</p> <p>Enter DEST, followed by a space, and enter data for refinement DEST if the call destination is known.</p>

AMCODE (continued)**Field descriptions for conditional datafill (Sheet 3 of 13)**

Field	Subfield or refinement	Entry	Explanation and action
			<p>Enter EXTCIC, followed by a space, and datafill refinements SOURCE, SKIPDIGS, and CICSIZE. EXTCIC is the external carrier identification code that indicates a long distance carrier in the global environment. This option is only supported for TOPS calls. For further information, refer to functionality Global Competitive Access, GOS00006.</p> <p>Enter IAA and the datafill refinement IAA_INDEX to generate or modify IAA message parameters based on datafill in table IAACtrl.</p> <p>Enter MM, followed by a space, and enter data for refinements MIN and MAX. Enter this subfield if the minimum and maximum number of expected digits dialed are known. These values include the digits used to index the current tuple and must also include the prefix digits specified in the current tuple.</p> <p>Note: For fast interdigital timing to function properly, MM can only be used with the RTE selector when the value in refinement MIN is not equal to the value in MAX. In other words, if MIN=MAX, MM can be used with the CONT selector in table PXCODE. If the value in refinement MIN is not equal to the value in refinement MAX, MM cannot be used until the RTE selector is used. If refinements MIN and MAX are set in table PXCODE when they are not equal to each other, partial dial timing is used after MIN digits are dialed to determine the end of dialing.</p> <p>Enter MZONE, followed by a space, and datafill refinement MZONE, if metering is done on the call.</p> <p>Enter NETSRV and datafill refinement NETSRV_NAME to indicate a Japan network service.</p>

AMCODE (continued)

Field descriptions for conditional datafill (Sheet 4 of 13)

Field	Subfield or refinement	Entry	Explanation and action
			<p>Enter PCC, followed by a space, and datafill refinement PCCDR, if a pseudo country code is required.</p> <p>Enter PF, followed by a space, and datafill refinement PFDIGS, the prefix fence. This is the number of prefix digits associated with this tuple. That is, if some prefix digits were identified in a previous table, the number here is added to the existing value. Prefix digits are not used to index any further translation tables and are not outpulsed, but they remain stored in call detail records (CDR).</p> <p>Enter PIP to perform a residency check for the digits being translated. The local number portability feature uses the residency check to make sure that calls to DNs which have been ported in to the office are not routed out of the office. The PIP option does not have refinements.</p> <p>Enter PNRF to invoke the ported number recognition function, which LNP applications in Germany use. The PNRF option does not have refinements.</p> <p>Enter PRESEL, followed by a space, if the call is to be treated as a preselected carrier case.</p> <p>Enter PRESELRTE, followed by a space, and datafill refinement PRESELRTE, the index into the route table of the current XLASYS and XLANAME.</p>

AMCODE (continued)**Field descriptions for conditional datafill (Sheet 5 of 13)**

Field	Subfield or refinement	Entry	Explanation and action
			<p>Enter PRIVL, followed by a space, and datafill refinement PRIVL, if the user is a privileged user (for example, operators).</p> <p>Enter SETCDN, followed by a space, and enter data for the CDNNAME refinement. This option assigns the called number name (CDNNAME) from table CDNCHAR to the call.</p> <p>Enter TELETAXE. This option does not have refinements.</p> <p>Enter TOC, followed by a space, and datafill refinement CHG for the type of charge where the type of charge messaging is to be selected.</p> <p>Enter VPN, followed by a space, and datafill refinements ONNET and BILLABLE if the call routes through a service switching point (SSP) and feature package NTXH49AA or NTXH49AB (VPN-SSP) is in the switching unit.</p>
	ACF	0 to 29	<p>Area code fence. If the entry in subfield OSEL is ACF, datafill this refinement. Enter the number of digits between the beginning of the digits to currently index the table, and the end of the area code.</p>
	BILLABLE	Y or N	<p>Virtual private network billable call. If the entry in subfield OSEL is VPN, enter Y if an automatic message accounting (AMA) record is required for each VPN call. Otherwise, enter N.</p> <p>An AMA record is not generated if an address complete message (ACM) of address complete, no charge is returned, or if the call terminates in the SSP on a line with the free number terminating (FNT) option.</p>

AMCODE (continued)

Field descriptions for conditional datafill (Sheet 6 of 13)

Field	Subfield or refinement	Entry	Explanation and action
	CALLCLASS	PRESELECT OVERRIDE, CSN,TRUNK	Call class. If the entry in subfield OSEL is PRESEL, enter PRESELECT to treat the DN as a preselected call. Enter OVERRIDE to permit the DN to use override codes. Enter CSN to treat the DN as a carrier specific number. Enter TRUNK to permit access to trunk originated calls.

AMCODE (continued)**Field descriptions for conditional datafill (Sheet 7 of 13)**

Field	Subfield or refinement	Entry	Explanation and action
	CALLCTRL	CALLED, CALLING, LAST, or MUTUAL	<p>Call control. If the entry in subfield OSEL is CALLCTRL, datafill this refinement. Enter one of the following values to specify the party controlling the call:</p> <ul style="list-style-type: none"> • If the entry is CALLED and the called line goes on-hook first, the call is released immediately. If the calling line goes on-hook first and does not reanswer, the connection is not released until the called line goes on-hook. There are no time-outs, and the calling party is allowed to reanswer until the called line goes on-hook. Calls to lines with option ESG must have CALLCTRL(CALLED). Calls terminating on an ITOPS position must have CALLCTRL(CALLED). • If the entry is CALLING and the calling line goes on-hook first, the call is released immediately. If the called line goes on-hook first, the called party is allowed to reanswer within a datafilled reanswer time-out or until the calling line goes on-hook. If the time-out expires or if the calling line goes on-hook, the calling party releases the call and the called line is set to idle. • If the entry is LAST, the call is released when the later of the called party or the calling party goes on-hook. If either party goes on-hook, that party is allowed to reanswer within a datafilled reanswer time-out or until both parties go on-hook. • If the entry is MUTUAL and either line goes on-hook, the call is released immediately.
	CDNNAME	alphanumeric string	Called number name. If the entry in subfield OSEL is SETCDN, enter data for refinement CDNNAME to assign the CDNNAME from table CDNCHAR.

AMCODE (continued)**Field descriptions for conditional datafill (Sheet 8 of 13)**

Field	Subfield or refinement	Entry	Explanation and action
	CHG	SEND_ CHARGE or SEND_NO_ CHARGE	Charge. If the entry in subfield OSEL is TOC, enter SEND_CHARGE to set the answer message (BTUP ANM) type of answer (TOA) string sent out from a node to SEND_CHARGE. Enter SEND_NO_CHARGE to set the answer message (BTUP ANM) type of answer (TOA) string sent out from a node to SEND_NO_CHARGE.
	CICSIZE	1 to 4	CIC size. If the entry in subfield OSEL is EXTCIC, datafill this refinement. This field indicates how many digits are in the CIC. This field operates on the B (called) number, so it is assumed that the CIC is signalled as part of the B number. The MAP display indicates the range is 0 to 4; however, the system does not allow 0.
	CLDFMT	CURRENT POSTXLA	Called format. If the entry in subfield OSEL is CAMA, enter either CURRENT or POSTXLA to produce the required ICAMA record format. If the entry is CURRENT, an ICAMA record is produced with the signaled DN (without translation). If the entry is POSTXLA, an ICAMA record is produced with a PSTN number resulting from translations.

AMCODE (continued)**Field descriptions for conditional datafill (Sheet 9 of 13)**

Field	Subfield or refinement	Entry	Explanation and action
	CLASS	ATT, CNTL, COLL, DATT, EMRG, IAGRP, ICNTL, INTL, IOPRA, LCL, NATL, OPRA, RURAL, SPEC, UNKW, or URBAN	<p>Translation class. If the entry in subfield OSEL is CLASS, enter the translation class determined by the dialed digits. This can be used for screening or billing as described under CLASS in screening and charging options.</p> <p>The translation classes are defined as follows:</p> <ul style="list-style-type: none"> • ATT (attendant console) • CNTL (continental) • COLL (collect) • DATT (dial attendant) • EMRG (emergency) • IAGRP (interagent group) • ICNTL (intercontinental) • INTL (international) • IOPRA (international operator assisted) • LCL (local) • NATL (national) • OPRA (operator assisted) • RURAL (rural) • SPEC (special) • UNKW (unknown) • URBAN (urban)
	CONDIGS	0 to 29	Consumed digits. If the entry in subfield OSEL is CONSUME, datafill this refinement. Enter a number to explicitly define the number of digits consumed during call processing.
	CONTINUE	CONT, NOCONT	Continue. If the entry in subfield OSEL is PRESEL, enter CONT to continue translations through UXLA. Enter NOCONT to immediately route translations through PCIXLA or PCITRK.

AMCODE (continued)**Field descriptions for conditional datafill (Sheet 10 of 13)**

Field	Subfield or refinement	Entry	Explanation and action
	CPMCALL	Y or N	Called party metering. If the entry in subfield OSEL is CPMCALL, enter Y (yes) if calls are billed against the called party for intraoffice calls. Enter N (no) for the default value of billing against the calling party for intraoffice calls.
	DDIDX	0 to 63 or DEFAULT	Destination discount index. If the entry in subfield OSEL is DDIDX, enter data for refinement DDIDX if a destination discount applies to the call.
	DEST	0 to 1023	Destination route list index. If the entry in subfield OSEL is DEST, enter the number in the route list, of the same translation system, that the call is routed to.
	IAA_INDEX	0 to 1024	Interadministration accounting index. If the entry in subfield OSEL is IAA, Datafill this refinement. Enter the value that indexes the corresponding tuple in IAACtrl.
	LNET	alphanumeric (1 to 16 characters)	Logical network. If the entry in subfield OSEL is LNET, enter the logical network name that the call is on. The logical network name must be previously datafilled in table LNETWORK. The entry in this field is used by the international metering system to determine a tariff for the call.
	MAX	0 to 30	Maximum digits. If the entry in subfield OSEL is MM, datafill this refinement. Enter the maximum number of digits expected. This value includes the digits used to index the current tuple and must also include the prefix digits specified in the current tuple.
	MIN	0 to 30	Minimum digits. If the entry in subfield OSEL is MM, datafill this refinement. Enter the minimum number of digits expected. This value includes the digits used to index the current tuple and must also include the prefix digits specified in the current tuple.

AMCODE (continued)**Field descriptions for conditional datafill (Sheet 11 of 13)**

Field	Subfield or refinement	Entry	Explanation and action
	MZONE	0 to 63	Metering zone. The entry in this field is used by the international metering system to determine a tariff for the call. If the entry in subfield OSEL is MZONE, enter the metering zone of the call, in the logical network as defined by selector LNET.
	NETSRV_ NAME	IPHS, DPHS, MOBILE, DA, TELEGRAM, or NCC	<p>Network service name. If the entry in subfield OSEL is NETSRV, datafill this refinement. The entry in this field determines the parameters in an outgoing IAM message.</p> <p>Enter IPHS to indicate a call to an independent personal handyphone system subscriber.</p> <p>Enter DPHS to indicate a call to a dependent personal handyphone system subscriber.</p> <p>Enter MOBILE to indicate a call to a mobile subscriber.</p> <p>Enter DA to indicate a call to the directory assistance operator.</p> <p>Enter TELEGRAM to indicate a call to the Telegram office.</p> <p>Enter NCC to indicate a call routed to one of the following networks:</p> <ul style="list-style-type: none"> • New Common Carrier serving international toll traffic • New Common Carrier serving national toll traffic
	NOA	INTL, LOCAL, NATL, or NET	<p>Nature of address. Enter the required called party nature of address.</p> <ul style="list-style-type: none"> • INTL (international) • LOCAL (local) • NATL (national) • NET (Intelligent Network Services)

AMCODE (continued)**Field descriptions for conditional datafill (Sheet 12 of 13)**

Field	Subfield or refinement	Entry	Explanation and action
	ONNET	Y or N	<p>Call on virtual private network. If the entry in subfield OSEL is VPN, enter Y if the call stays within the defined virtual private network. Otherwise enter N.</p> <p>Overlapped outpulsing is only supported on off-network calls. Calls processed without subfield ONNET set to Y are off-network calls. Meridian Digital Centrex (MDC) calls are treated as off-network calls, and therefore overlapped outpulsing is supported for MDC calls.</p>
	PCCDR	0 to 9, B, C, D, E (1 to 3 digits)	<p>Pseudo country code digits. If the entry in subfield OSEL is PCC, enter the three-digit pseudo country code (PCC). If a two-digit PCC is required, it must be padded by a leading zero.</p> <p>The pseudo country code is used to record a particular pseudo country code. This can be extracted for use by system logic later, for example, two-stage outpulsing.</p>
	PFDIGS	0 to 24	<p>Number of prefix digits. If the entry in subfield OSEL is PF, datafill this refinement. Enter the number of prefix digits. If prefix digits are identified in a previous table, this number is added to the existing value. Prefix digits are not used to index any further translation tables and are not outpulsed, but they remain stored in call detail records (CDR).</p> <p>Note: If refinements PF and CONSUME are both datafilled for the same tuple, only the entry for the greater of the two values is processed; the other entry is ignored.</p>
	PFXAMA	0 to 4 digits, or N	<p>Called party number prefix in AMA. If NOA is set to NTL, datafill PFXAMA with 0011.</p> <p>If NOA is set to NATL, datafill PFXAMA with 0.</p> <p>If NOA is set to LOCAL or NET, datafill PFXAMA with N.</p>

AMCODE (continued)**Field descriptions for conditional datafill (Sheet 13 of 13)**

Field	Subfield or refinement	Entry	Explanation and action
	PRIVL	Y or N	Privileged user. If the entry in subfield OSEL is PRIVL, enter Y (yes), if the user is a privileged user (for example, operator). Otherwise, enter N (no).
	SKIPDIGS	0 to 24	Skip digits. If the entry in subfield OSEL is EXTCIC, datafill this refinement. This field indicates how many digits to skip before extracting the carrier digits from the digit stream. This field operates on the B (called) number, so it is assumed that the CIC is signalled as part of the B number.
	SOURCE	PRESUB or DIALED	Carrier identification code source. If the entry in subfield OSEL is EXTCIC, datafill this refinement. This field specifies the source of the CIC as follows: <ul style="list-style-type: none"> • PRESUB - presubscribed, the CIC is defined in table TRKGRP • DIALED - dialed, the CIC is entered by the subscriber when dialing a call
	STOPRTMR	Y or N	Stop remote timer. Enter Y (yes) to disable the address complete message (ACM) timer of the remote switch. Default is N (no).
	XLAID	FREE, GENERIC1, GENERIC2, or GENERIC3	AMA translation identifier. If the entry in subfield OSEL is AMAXLAID, enter the AMA translation identifier to be used against table AMAXLAID.

XLASEL = TRMT

If the entry in subfield XLASEL is TRMT, datafill the following refinements.

AMCODE (continued)

Route to the specified treatment. A treatment is a known exception or failure condition. The action taken terminates translation, returning an indication that a treatment was encountered and decoded into a route.

Field descriptions for conditional datafill

Field	Subfield or refinement	Entry	Explanation and action
	OPT	see subfield	Options. This field is a vector consisting of up to ten options. Each option consists of subfield OSEL, and refinements that depend on the entry in subfield OSEL. For each option, specify the option selector (OSEL), followed by a space, and the refinements, each separated by a space. The entry is concluded by a \$ and datafill continues with field DFOP.
	OSEL	OFC	Option selector. Enter OFC, followed by a space, and datafill refinement OFC, if a treatment name is required.
	OFC	alphanumeric (1 to 4 characters)	Office treatment. Enter a treatment name that is contained in the office treatment subtable, TMTCNTL.TREAT.

Datafill example

An example of datafill for table AMCODE and related tables is shown below.

The example shows the datafill for the office code subtable, OFC234, that references ambiguous code subtable AM234. The dialed digits are 234-727-1364.

Since more digits were dialed than for a local call, the route is changed. Default options apply with selector RTE, so the default options are taken from table OFCHEAD tuple with XLANAME OFC234. The destination reference given in table AMCODE tuple applies to the fourth route list in subtable OFC234 of table OFCRTE. Note that CLASS NATL and DEST 4 in table AMCODE override CLASS LCL and DEST 2 in table OFCCODE. If desired, as shown here, the ambiguous code table can be referred to, after a destination is found if it can change depending on the number of digits dialed.

If no ambiguous code tuple is selected, the entry in field DFLT from tuple AM234 in table AMHEAD is used.

AMCODE (continued)

Although the table AMCODE result indicates that there are eight or more digits, the call is routed to destination 4, option MM in table OFCHEAD directs that a maximum of ten digits are allowed. Option MM takes precedence over the ambiguous code table results. If more than ten digits are dialed, the call is not routed. Note that care must be taken that the values do not conflict, but rather that MM provides a boundary for the ambiguous code results.

MAP display example for table OFCHEAD

XLANAME		DFLT
		DFOP
CON	MAXIDX	

OFC234		SDFLT
DFOP (MM 6 10) \$		
NOCON	9	

MAP display example for table OFCCODE

XLANAME	FROMD	TOD	XLADATA

OFC234	234	235	
CONT (XLT AM AM234) (DEST 2) (CLASS LCL) \$			

MAP display example for table OFCRTE

XLANAME	RTEREF	RTELIST

OFC234	2	
		(N LOCALCLLI DEL 3 PFXDIGS 09) \$
OFC234	4	
		(S NEXTOWN) \$

AMCODE (continued)**MAP display example for table AMHEAD**

XLANAME	DFLT
AM234	SDFLT

MAP display example for table AMCODE

XLANAME	NUMDIGS	RELATION	XLADATA
AM234 RTE (DEST 4)	8 (CLASS NATL)	GE \$	

Table history**MMP13**

Added subfield CHGIND to selector CONT with entries CHARGE and NO_CHARGE for feature AU3510. Corrected weight of table line rules and removed double spaces in text throughout.

APC010

Added field TLC_CHARGE to option TLC in the FEATINFO selector.

LET010

Added option EXTCIC to selectors CONT, DMOD, and RTE.

APC009.1

Added station ringer test (SRT) information.

APC009

Added option NETSRV to selectors CONT and RTE.

Added option JES to selector FEATINFO.

AMCODE (continued)

GL04

New entries were added to the XLADATA field.

APC008.1

The following updates were introduced in APC008.1 to table AMHEAD:

- Field CHKCCR was added to all subscriber types (SUBSCTYP) that are part of the SUBSCRN option of selector FEATINFO VALIDATE.
- Field EARLYCPG was added to selector FEATINFO.
- Option IAA was added to selectors ROUTE and CONT.

GL03

The following updates were introduced in GL03 to table AMCODE:

- provided the ability to datafill ACF in RTE and CONT selectors
- provided the ability to datafill CAMA in RTE, CONT, and DNRTE selectors
- added URBAN to selector CLASS
- applied effectivity to GL03 specific sections

GL004

Added new OSEL options.

APC008

The following updates were introduced in APC0008 to table AMCODE:

- option TRUNK was added to field CALLCLASS of option PRESEL of selector RTE
- option TRUNK was added to field CALLCLASS of option PRESEL of selector CONT
- option PRESEL was added to field VALDATOP in selector FEATINFO

APC007

The following updates were introduced in APC07 to table AMCODE:

- option PRESEL was added to selector RTE
- option PRESEL was added to selector CONT

AMCODE (continued)

NA005

The following updates were introduced in NA005 to table AMCODE:

- increased the number for universal translations support to 30 digits, affecting the following options, subfields or selectors:
 - ACF
 - AFTER
 - CONSUME
 - DEL
 - DMOD
 - DNRTE
 - INSRT
 - MAX
 - MIN
 - PF
 - REPL
- added option SF and its refinement to selector DNRTE
- added note about potential conflict with refinements CONSUME and PFDIGS

APC006

PERSONAL subscriber type added to SUBSCRN option of FEATINFO VALIDATE.

APC004

Features CALLBACK, CALLCHAR, CLCTDIGS, NTC, and TLC were added to the FTR field of selector FEATINFO.

Options CLDTCOLG, LCASCRN, TCNOTSCR, VERDEST, and V3PTYBIL were added to the VALDATOP subfield of selector FEATINFO.

Subfield CDN of selectors CONT and RTE was modified to incorporate subfields NOA, STOPRTMR, and PFXAMA.

BCS36

Option CUSTMOD was added to refinement VALDATOP for XLASEL = FEATINFO.

BCS35

The following information was added:

- PRDFXCLI
- INSRTCLI
- value BCSCRN to field VALDATOP
- a general note on restrictions of use of VALIDATE
- field CONSUME
- CPMCALL to XLASEL CONT, RTE

AMHEAD

Table name

Ambiguous Code Head

Functional description

Tables AMHEAD and AMCODE form the ambiguous code translations system in the universal translations system. These tables are used when it is necessary to know the total number of digits dialed if that total affects the outcome of translation.

The tables are divided into subtables, which each translate one ambiguous code. Each subtable is defined by one tuple in table AMHEAD. Table AMCODE has any number of tuples, but usually two. The first field of each AMCODE tuple is the name of the subtable to which it belongs. The next fields of table AMCODE are fields NUMDIGS and RELATION, followed by translations data consisting of a translation selector and options. Table AMCODE is keyed at the MMI (man-machine interface) level by the subtable name and field NUMDIGS.

A tuple is selected from table AMCODE by comparing the total number of digits dialed (excluding prefix digits) with the value of field NUMDIGS. If the relationship of the number of digits to field NUMDIGS is as specified in field RELATION, the correct tuple has been found. For example, if field NUMDIGS has a value of 8 and field RELATION is EQUAL (EQ), that tuple is selected only if eight digits are dialed. If no tuple relation is satisfied in subtable AMCODE, the default tuple from table AMHEAD is used.

The ambiguous code translations system can be referenced from any subtable UXLA by using translation selector CONT or DMOD with option XLT. Subfield XLASYS is AM and field XLANAME is a user-defined subtable name that is datafilled in table AMHEAD. The resultant tuple is interpreted in the context of the previous subtable, the one that references it. Any default options are taken from field DFOP of the xxHEAD table of the previous translation system, and if a destination is set in table AMHEAD or table AMCODE, it refers to the route table (xxRTE) of the previous translations system. If the previous xxCODE table gives a value to an option and table AMCODE resets the value, the value in table AMCODE is used because it was set later, on the basis of additional information.

Note: If selector CONT is used in the ambiguous code table, the next table to be entered can be found in a number of places. First, it can be datafilled (with option XLT) into the xxCODE table tuple. If not there, it can come from the default options (DFOP) of the previous xxHEAD table. As described in table ACHEAD, whether translation continues or goes into an

AMHEAD (continued)

endless loop depends on whether option CON or NOCON in the previous xxHEAD table has been set. If selector DMOD is used, option XLT must be datafilled into the AMCODE tuple, because default options do not apply.

Table AMHEAD is used to define value XLANAME (translation name) and default if a tuple is not found in table AMCODE with the same XLANAME.

Position in outgoing digit stream

The area code fence (ACF) option, available in field OSEL, is used to indicate that an area code is in the digit string. Associated with this option is field ACF, which contains the digit count. This digit count indicates the number of digits between the beginning of the digits used to currently index the table and the end of the area code.

Option ACF is applicable to translation selectors CONT and RTE.

When a KC (or KE = 13) forward connection control signal is sent forward on an outgoing MFC trunk, option ACF is used to determine where the signal is placed in the outgoing stream.

The length of an area code in China is based on the following algorithm:

- If the first digit is 1, then the length of the area code is one digit.
- If the first digit is 2, then the length of the area code is two digits.
- If the first digit is 3 to 9 and the second digit is odd, then the length of the area code is three digits.
- If the first digit is 3 to 9 and the second digit is even, then the length of the area code is four digits.

Note: If an entry is deleted from an xxHEAD table, all xxCODE table entries with the given value XLANAME are deleted. However, all XLT option references to the deleted XLANAME in other tables must be removed manually. If references to a deleted XLANAME are not removed, translations cannot continue when it reaches the missing reference and a call dump occurs.

Datafill sequence and implications

There is no requirement to datafill other tables prior to table AMHEAD.

If the translation selector DBQ is used, table NSCDEFS must be datafilled before table AMHEAD.

AMHEAD (continued)

If the optional selector CGNDM is used with translation selector DMOD, the default Calling Line Identification (CLI) must be datafilled in table TRKSGRP. Different default CLIs can be datafilled on requirements.

Optional selector CGNDM must also be datafilled in table ACCODE to activate the feature.

For option selector CAMA (used in translation selectors CONT and RTE), set office parameter ICAMA_REQUESTED in table OFCVAR to Y (yes) when ICAMA detailed call recording is required.

An IAA record can be generated by selecting office parameter IAA_REQUESTED in table OFCVAR and selector CAMA.

Office parameter IMEI_ACCEPTABLE_FOR_EMRG_CALL in table OFCVAR provides an option for the network operator to accept emergency call setups from mobile stations that transmit the international mobile equipment identifier (IMEI) instead of the international mobile subscriber identifier (IMSI) or temporary mobile subscriber identifier (TMSI). The default value allows emergency call setups with IMEI as the identifier if, for example no serial interface module (SIM) is present.

Only automatic number identification (ANI) and international metered (MTR) trunk group originations currently support the option selector CAMA. All other call types ignore this translation option.

For emergency calls translation, class EMRG has to be datafilled. This can be done before or after translation selector DMOD with option selector COODM. This requirement differentiates between normal mobile originated calls and emergency calls set up by a conventional SETUP message.

Table size

The size of table AMHEAD varies from 0 to 2047 tuples.

Memory is dynamically allocated.

AMHEAD (continued)**Datafill**

The following table lists datafill for table AMHEAD.

Field descriptions (Sheet 1 of 3)

Field	Subfield or refinement	Entry	Explanation and action
XLANAME		alphanumeric (1 to 8 characters)	Translation name. Enter the name assigned to the ambiguous code subtable. There are no restrictions on the name, but it makes the tables more readable if the name contains the ambiguous code that is being translated. For example, ambiguous code 292 could be translated in subtable AM292.
CONTMARK		+	Continuation mark. Enter + to indicate that additional information for this tuple is contained in the next record.
DFLT		see subfield	Default translations data. This is the result that translations uses if the dialed digits are not datafilled in the ACCODE table associated with table ACHEAD. This field consists of subfield DFLTSEL and refinements dependent on the entry in field DFLTSEL.
	DFLTSEL	DFLT or SDFLT	Default selector. Enter DFLT and datafill refinement XLASEL if the standard default is not correct. Enter SDFLT, if a standard default is required for dialed digits not found in the ACCODE table. The standard default is TRMT OFC VACT. That is, if dialed digits are not found in ACCODE, the call is routed to vacant code treatment. No additional datafill is required.
	XLASEL	CONT, DBQ, DMOD, DNRTE, FEAT, FEATINFO, HRC, IAC, RTE, or TRMT	Translations selector.

AMHEAD (continued)**Field descriptions (Sheet 2 of 3)**

Field	Subfield or refinement	Entry	Explanation and action
			Enter CONT and datafill refinement CONT if further translation is required.
			Enter DBQ and datafill refinement DBQ to perform a database query.
			Enter DMOD and datafill refinement DMOD if input digit stream modification is required.
			Enter DNRTE and datafill refinement DNRTE if input digit routing is required.
			Enter FEAT and datafill refinement FEAT if access to a feature is required.
			Enter FEATINFO and datafill refinement FEATINFO to trigger the screening function.
			Enter HRC and enter data for its refinements if the home routing code selector is required for local number portability applications.
			Enter IAC and datafill refinement IAC if the insertion of own area code is required when an ambiguous area code is found through translations.
			Enter RTE and datafill refinement RTE if a translation result was found, and translation is to terminate.

AMHEAD (continued)

Field descriptions (Sheet 3 of 3)

Field	Subfield or refinement	Entry	Explanation and action
	DFOP	DFOP or NODFOP	<p>Enter TRMT and datafill refinement TRMT if a call is routed to a treatment.</p> <p>Default options. Enter DFOP and datafill subfield OSEL and its refinements.</p> <p>The default options only apply if a tuple with field XLASEL set to RTE or CONT is chosen in xxCODE table.</p> <p>If the entry in field DFOP is DFOP, this field is a vector that consists of a number of options. Each option consists of subfield OSEL and refinements dependent on the entry in subfield OSEL. The various refinements are identical to the refinements described in field DFLT, selector CONT, subfield OSEL.</p> <p>For each option, specify the option selector, followed by a space, and the refinements, with each refinement separated from the next by a space. The entry is concluded by a \$ and datafill continues with field CON.</p> <p>Enter NODFOP if there are no default options and datafill field CON.</p>

XLASEL = CONT

If the entry in field XLASEL is CONT, datafill the following refinements.

AMHEAD (continued)

Table AMAXLAID must be datafilled prior to selecting option AMAXLAID in field OSEL.

Field descriptions for conditional datafill (Sheet 1 of 14)

Field	Subfield or refinement	Entry	Explanation and action
	OPT	see subfield	Options. This field is a vector consisting of up to ten options. Each option consists of subfield OSEL and refinements that depend on the entry in subfield OSEL. For each option, specify the option selector (OSEL), followed by a space, and the refinements, each separated by a space. The entry is concluded by a \$ and datafill continues with field DFOP.
	OSEL	ACF, AMAXLAID, CALLCTRL, CAMA, CDN, CDNRTE, CHGIND, CLASS, CLIOVRD, CONSUME, CPCRTE, CPMCALL, DDIDX, DEST, EXTCIC, IAA, LNET, MM, MZONE, NETSRV, OSS, PCC, PF, PNRF, PRESEL, PRIVL, QFT, SETCDN, TELETAXE, TOC, VPN, or XLT	<p>Option selector. The following options can be selected:</p> <p>Enter ACF, followed by a space, and datafill refinement ACF if the area code fence is defined.</p> <p>Enter AMAXLAID, followed by a space, and datafill refinement XLAID to specify an automatic message accounting (AMA) identity from within table AMAXLAID.</p> <p>Enter CALLCTRL, followed by a space, and datafill refinement CALLCTRL. The entry in refinement CALLCTRL indicates who has control of the call: the calling party, the called party, or both.</p> <p>Enter CAMA, followed by a space, and datafill refinement CLDFMT. The entry in field CLDFMT indicates whether the international centralized automatic message accounting (ICAMA) record is generated with the the originally signaled directory number (DN) or the final public switched telephone network (PSTN) number.</p>

AMHEAD (continued)**Field descriptions for conditional datafill (Sheet 2 of 14)**

Field	Subfield or refinement	Entry	Explanation and action
			<p>Enter CDN, followed by a space, and datafill refinement CDN to select the nature of address field. This field is used to identify the called party of the initial address message (IAM). It is used for Australian ISDN user part (AISUP) call translations.</p> <p>Enter CDN RTE to route using the called number name (CDNNAME) from table CDNCHAR. If the CDNNAME is present on the incoming call or is set by the SETCDN option, translation proceeds to table CDNUXLA.</p> <p>Enter CHGIND, followed by a space and datafill refinement CHGIND to override the charge indicator value received from an incoming trunk message. This entry is specific to JCTV.</p> <p>Enter CLASS, followed by a space, and datafill refinement CLASS if the class of the dialed digits can be determined.</p> <p>Enter CLIOVRD, followed by a space, and enter data for refinement CLIOVRD. This subfield indicates calling line identity override.</p> <p>Enter CONSUME, followed by a space, and datafill refinement CONDIGS to specify the number of digits that are consumed during translation.</p> <p>Enter CPC RTE to route using the calling party category (CPCNAME) from table CPCCHAR. If the CPCNAME is present on the incoming call, translation proceeds to table CPCUXLA.</p> <p>Enter CPMCALL, followed by a space, and datafill refinement CPMCALL to specify call billing against the called party instead of the calling party for intra-office calls.</p>

AMHEAD (continued)

Field descriptions for conditional datafill (Sheet 3 of 14)

Field	Subfield or refinement	Entry	Explanation and action
			<p>Enter DDIDX, followed by a space, and enter data for refinement DDIDX. Enter data for this subfield for the destination discount index.</p> <p>Enter DEST, followed by a space, and datafill refinement DEST if the destination is known.</p> <p>Enter EXTCIC, followed by a space, and enter data for refinements CICSIZE, SKIPDIGS, or SOURCE. Enter EXTCIC for the external carrier identification code</p> <p>Enter IAA and the datafill refinement IAA_INDEX to generate or modify IAA message parameters based on datafill in table IAACtrl.</p> <p>Enter LNET, followed by a space, and datafill refinement LNET if a logical network is required for metering.</p> <p>Enter MM, followed by a space, and datafill refinements MIN and MAX if the minimum and maximum dialed digits are known.</p> <p>Enter MZONE, followed by a space, and datafill refinement MZONE if metering is to be done on the call.</p> <p>Enter NETSRV and datafill refinement NETSRV_NAME to indicate a Japan network service.</p> <p>Enter OSS for the operator signaling service. The OSS subfield does not have refinements.</p> <p>Enter PCC, followed by a space, and datafill refinement PCCDR if a pseudo country code is required.</p> <p>Enter PF, followed by a space, and datafill refinement PFDIGS if there are prefix digits in the digit stream.</p>

AMHEAD (continued)**Field descriptions for conditional datafill (Sheet 4 of 14)**

Field	Subfield or refinement	Entry	Explanation and action
			<p>Enter PNRF to invoke the ported number recognition function, which is used for LNP applications in Germany. The PNRF option does not require any subfields.</p> <p>Enter PRESEL and datafill refinement PRESEL to provide the necessary information used to index into the PCIXLA table.</p> <p>Enter PRIVL, followed by a space, and datafill refinement PRIVL if the user is a privileged user (for example, operators).</p> <p>Enter QFT followed by ON or OFF to indicate if an outgoing route is capable of QSIG Feature Transparency.</p> <p>Note: The QFT ON option must not be added to a route unless the far-end node is QFT-capable.</p> <p>Enter SETCDN to trigger the setting of outgoing called party characteristics. This option assigns the called number name (CDNNAME) from table CDNCHAR to the call. If the CDNRTE option is subsequently encountered, the CDNNAME is used to route the call.</p> <p>You can use the SETCDN option to allow CDN routing when incoming agents such as DPNSS or BTUP are not available in table CDNCHAR.</p> <p>Enter TELETAXE. This subfield does not have refinements.</p>

AMHEAD (continued)**Field descriptions for conditional datafill (Sheet 5 of 14)**

Field	Subfield or refinement	Entry	Explanation and action
			<p>Enter TOC, followed by a space, and datafill refinement CHG for the type of charge if the type of charge messaging is selected.</p> <p>Enter VPN, followed by a space, and datafill refinements ONNET and BILLABLE if the call routes through a service switching point (SSP) and feature package NTXH49AA or NTXH49AB (VPN - SSP) is in the switching unit.</p> <p>Enter XLT, followed by a space, and datafill refinement XLASYS if the call is to proceed to another translation system.</p>
	ACF	0 to 29	Area code fence. If the entry in subfield OSEL is ACF, datafill this refinement. Enter the number of digits between the beginning of the digits to currently index the table, and the end of the area code.
	BILLABLE	Y or N	Virtual private network billable call. If the entry in subfield OSEL is VPN, datafill this refinement. Enter Y if an AMA record is required for each VPN call. Otherwise, enter N. An AMA record is not generated if an address complete message (ACM) of address complete - no charge is returned, or if the call terminates in the SSP on a line with the free number terminating (FNT) option.
		PRESELECT OVERRIDE, CSN, or TRUNK	<p>Preselection call processing. If the entry in subfield OSEL is PRESEL, datafill this refinement. Enter the preselection call class type that is associated with the call.</p> <p>Note: Calltype CSN and TRUNK are available under the PRESEL option. These call classes are not needed for German Carrier Selection, and are not supported. The same applies to the Continue option of CONT. For the German market only, NOCONT is supported.</p>

AMHEAD (continued)**Field descriptions for conditional datafill (Sheet 6 of 14)**

Field	Subfield or refinement	Entry	Explanation and action
	CALLCTRL	CALLED, CALLING, LAST, or MUTUAL	<p>Call control. If the entry in subfield OSEL is CALLCTRL, datafill this refinement. Enter one of the following values to specify the party controlling the call:</p> <ul style="list-style-type: none"> If the entry is CALLED and the called party goes on-hook first, the call is released immediately. If the calling line goes on-hook first and does not reanswer, the connection is not released until the called line goes on-hook. There are no time-outs, and the calling party is allowed to reanswer until the called line goes on-hook. <p>Calls to lines with option ESG must have CALLCTRL(CALLED).</p> <p>Calls terminating on an International Traffic Operator Position System (ITOPS) must have CALLCTRL (CALLED).</p>
	CALLCTRL (continued)		<p>Call control (continued). Enter one of the following values to specify the party controlling the call:</p> <ul style="list-style-type: none"> If the entry is CALLING and the calling line goes on-hook first, the call is released immediately. If the called line goes on-hook first, the called party is allowed to reanswer within a datafilled reanswer time-out or until the calling line goes on-hook. If the time-out expires or if the calling line goes on-hook, the calling party releases the call and the called party is set to idle. If the entry is LAST, the call is released when the later of the called party or the calling party goes on-hook. If either party goes on-hook, that party is allowed to reanswer within a datafilled reanswer time-out or until both parties go on-hook. If the entry is MUTUAL and either line goes on-hook, the call is released immediately.

AMHEAD (continued)**Field descriptions for conditional datafill (Sheet 7 of 14)**

Field	Subfield or refinement	Entry	Explanation and action
	CDNNAME	alphanumeric string	If the entry in subfield OSEL is SETCDN, enter data for refinement CDNNAME. Enter CDNNAME to route the call using a called number name from table CDNCHAR.
	CHG	SEND_CHARGE or SEND_NO_CHARGE	Charge. If the entry in subfield OSEL is TOC, datafill this refinement. Enter SEND_CHARGE to set the answer message (BTUP ANM) type of answer (TOA) string sent out from a node to SEND_CHARGE. Enter SEND_NO_CHARGE to set the answer message (BTUP ANM) type of answer (TOA) string sent out from a node to SEND_NO_CHARGE.
	CHGIND	ASIS, CHG, or NOCHG	CHGIND indicates whether to override the value of the charge indicator in the Backward Call indicators. The CHGIND option only applies to JCTV loads. Datafill the CHGIND field with the following values: <ul style="list-style-type: none"> • ASIS-treat charge indicator as is • CHG-treat charge indicator as charge • NOCHG-treat charge indicator as no charge
	CICSIZE	1 to 4	CIC size. If the entry in subfield OSEL is EXTCIC, enter data for this refinement. This field indicates the number of digits in the CIC. This field operates on the B (called) number, so it is assumed that the switch signals the CIC as part of the B number. The MAP display indicates the range is 0 to 4. The system does not allow a 0 entry.

AMHEAD (continued)**Field descriptions for conditional datafill (Sheet 8 of 14)**

Field	Subfield or refinement	Entry	Explanation and action
	CLASS	ATT, CNTL, COLL, DATT, EMRG, IAGRP, ICNTL, INTL, IOPRA, LCL, NATL, OPRA, RURAL, SPEC, UNKW, or URBAN	<p>Translation CLASS. If the entry in subfield OSEL is CLASS, datafill this refinement. Enter the translation class determined by the dialed digits, as listed below. (This can be used for screening or billing purposes as described under CLASS in screening and charging options.)</p> <ul style="list-style-type: none"> • ATT (attendant console) • CNTL (continental) • COLL (collect) • DATT (dial attendant) • EMRG (emergency) • IAGRP (interagent group) • ICNTL (intercontinental) • INTL (international) • IOPRA (international operator assisted) • LCL (local) • NATL (national) • OPRA (operator assisted) • RURAL (rural) • SPEC (special) • UNKW (unknown) • URBAN (urban)
	CLDFMT	CURRENT or POSTXLA	<p>Called format. If the entry in subfield OSEL is CAMA, enter either CURRENT or POSTXLA to produce the required ICAMA record format.</p> <p>If the entry is CURRENT, an ICAMA record is produced with the signaled DN (without translation).</p> <p>If the entry is POSTXLA, an ICAMA record is produced with a public switched telephone network (PSTN) number resulting from translations.</p>

AMHEAD (continued)**Field descriptions for conditional datafill (Sheet 9 of 14)**

Field	Subfield or refinement	Entry	Explanation and action
	CLIOVRD	CNA, CNB	Calling line identity override. If the entry in subfield OSEL is CLIOVRD, enter data for this refinement. Enter CNA to allow the calling number for each call. Enter CNB to block the calling number for each call.
	CONDIGS	numeric (0 to 29 digits)	Consumed digits. If the entry in subfield OSEL is CONSUME, datafill this refinement. Enter a number to explicitly define the number of digits consumed during call processing.
	CONTINUE	CONT, NOCONT	Continue. If the entry in subfield OSEL is PRESEL, enter data for this refinement. Enter CONT to continue translations through UXLA. Enter NOCONT to route translations through PCIXLA or PCITRK.
	CPMCALL	Y or N	Called party metering. If the entry in subfield OSEL is CPMCALL, datafill this refinement. Enter Y (yes) if calls are billed against the called party for intra-office calls. Enter N (no) for the default value of billing against the calling party for intraoffice calls.
	DDIDX	1 to 63 or DEFAULT	Destination discount index. If the entry in subfield OSEL is DDIDX, enter data for this refinement. Enter the destination discount index number from table ACOOPT.
	DEST	0 to 1023	Destination route list index. If the entry in subfield OSEL is DEST, datafill this refinement. Enter the number in the route list, of the same translation system, that the call is routed to.
	IAA_INDEX	0 to 1024	Interadministration accounting index. If the entry in subfield OSEL is IAA, datafill this refinement. Enter the value that indexes the corresponding tuple in table IAACTRL.

AMHEAD (continued)**Field descriptions for conditional datafill (Sheet 10 of 14)**

Field	Subfield or refinement	Entry	Explanation and action
	LNET	alphanumeric (1 to 16 characters)	Logical network. If the entry in subfield OSEL is LNET, datafill this refinement. Enter the logical network name that the call is on. The logical network name must be previously datafilled in table LNETWORK. The entry in this field is used by the international metering system to determine a tariff for the call.
	MAX	0 to 30	Maximum digits. If the entry in subfield OSEL is MM, datafill this refinement. Enter the maximum number of digits expected. This value includes the digits used to index the current tuple and must also include the prefix digits specified in the current tuple.
	MIN	0 to 30	Minimum digits. If the entry in subfield OSEL is MM, datafill this refinement. Enter the minimum number of digits expected. This value includes the digits used to index the current tuple and must also include the prefix digits specified in the current tuple.
	MZONE	0 to 63	Metering zone. If the entry in subfield OSEL is MZONE, datafill this refinement. Enter the metering zone of the call, in the logical network as defined by selector LNET. The entry in this field is used by the international metering system to determine a tariff for the call.

AMHEAD (continued)

Field descriptions for conditional datafill (Sheet 12 of 14)

Field	Subfield or refinement	Entry	Explanation and action
	ONNET	Y or N	<p>Call on virtual private network. If the entry in subfield OSEL is VPN, datafill this refinement. Enter Y if the call stays within the defined virtual private network. Otherwise, enter N.</p> <p>Overlapped outpulsing is only supported on off-network calls. Calls processed without subfield ONNET set to Y are off-network calls. Meridian Digital Centrex (MDC) calls are treated as off-network calls, and therefore overlapped outpulsing is supported for MDC calls.</p>
	PCCDR	0 to 9, B, C, D, E (1 to 3 digits)	<p>Pseudo country code digits. If the entry in subfield OSEL is PCC, datafill this refinement. Enter the three-digit pseudo country code (PCC). If a two-digit PCC is required, it must be padded by a leading zero.</p> <p>The pseudo country code is used to record a particular pseudo country code. This can be extracted for use by system logic later, for example, two-stage outpulsing.</p>
	PFDIGS	0 to 24	<p>Number of prefix digits. If the entry in subfield OSEL is PF, datafill this refinement. Enter the number of prefix digits. If prefix digits are identified in a previous table, this number is added to the existing value. Prefix digits are not used to index any further translation tables and are not outpulsed, but they do remain stored in call detail records (CDR).</p> <p>Note: If refinements PF and CONSUME are both datafilled for the same tuple, only the entry for the greater of the two values is processed; the other entry is ignored.</p>
	PFXAMA	0 to 4 digits, or N	<p>Called party number prefix in AMA. If NOA is set to NTL, datafill PFXAMA with 0011.</p> <p>If NOA is set to NATL, datafill PFXAMA with 0.</p> <p>If NOA is set to LOCAL or NET, datafill PFXAMA with N.</p>

AMHEAD (continued)**Field descriptions for conditional datafill (Sheet 13 of 14)**

Field	Subfield or refinement	Entry	Explanation and action
	PRIVL	Y or N	Privileged user. If the entry in subfield OSEL is PRIVL, datafill this refinement. Enter Y (yes), if the user is a privileged user (for example, operator). Otherwise, enter N (no).
	SKIPDIGS	0 to 24	Skip digits. If the entry in subfield OSEL is EXTCIC, enter data for this refinement. This field indicates the number of digits to skip before removing the carrier digits from the digit stream. This field operates on the B (called) number, so it is assumed that the system signals the CIC as part of the B number.
	SOURCE	PRESUB or DIALED	Carrier identification code source. If the entry in subfield OSEL is EXTCIC, enter data for this refinement. This field specifies the source of the CIC as follows: <ul style="list-style-type: none"> • PRESUB - presubscribed. Table TRKGRP contains the definition of the CIC. • DIALED - dialed. The subscriber enters the CIC when dialing a call.
	STOPRTMR	Y or N	Stop remote timer. Enter Y to disable the address complete message (ACM) timer of the remote switch. Default is N.
	XLAIID	FREE, GENERIC1, GENERIC2, or GENERIC3	AMA translation identifier. If the entry in subfield OSEL is AMAXLAID, datafill this refinement. Enter the AMA translation identifier to be used against table AMAXLAID.

AMHEAD (continued)

Field descriptions for conditional datafill (Sheet 14 of 14)

Field	Subfield or refinement	Entry	Explanation and action
	XLASYS	AC, AM, CT, FA, FT, NSC, OFC, PX	<p>Translation system. If the entry in subfield OSEL is XLT, datafill this refinement. Enter the next translation system to use, as listed below, followed by a space, then datafill refinement XLANAME:</p> <ul style="list-style-type: none"> • AC (access) • AM (ambiguous) • CT (country) • FA (foreign area) • FT (utility) • NSC (number service code) • OFC (office) • PX (prefix) <p>Note: NIL is not a valid entry. NIL is only used to satisfy internal software functionality. NSC is not used in GL03.</p>
	XLANAME	alphanumeric (1 to 8 characters)	<p>Translation name. If the entry in subfield OSEL is XLT, datafill this refinement. Enter the translation name of the table within the XLASYS to which the call is routed.</p>

AMHEAD (continued)**XLASEL = DBQ**

If the entry in field XLASEL is DBQ, datafill the following refinements.

Field descriptions for conditional datafill (Sheet 1 of 2)

Field	Subfield or refinement	Entry	Explanation and action
	OPT	see subfield	Options. This field is a vector consisting of up to ten options. Each option consists of subfield OSEL, and refinements that depend on the entry in subfield OSEL. For each option, specify the option selector (OSEL), followed by a space, then the refinements, each separated by a space. The entry is concluded by a \$ and datafill continues with field DFOP.
	OSEL	MM, NSC, or PF	Option selector. The following options can be selected: Enter MM, followed by a space, and datafill refinements MIN and MAX, if the minimum and maximum dialed digits are known. Enter NSC, followed by a space, and datafill refinement NSCODE, if a number service code operation is to be performed on a call. Enter PF, followed by a space, and datafill refinement PFDIGS if there are prefix digits in the digit stream.
	MAX	0 to 30	Maximum digits. If the entry in subfield OSEL is MM, datafill this refinement. Enter the maximum number of digits expected. This value includes the digits used to index the current tuple and must also include the prefix digits specified in the current tuple.
	MIN	0 to 30	Minimum digits. If the entry in subfield OSEL is MM, datafill this refinement. Enter the minimum number of digits expected. This value includes the digits used to index the current tuple and must also include the prefix digits specified in the current tuple.

AMHEAD (continued)**Field descriptions for conditional datafill (Sheet 2 of 2)**

Field	Subfield or refinement	Entry	Explanation and action
	NSCODE	AIN, 800P, E008, E800, MAP_HLR, MAP_MSC, MAP_VLR, PVN, MAPHLR, REPLDIGS, or VPN	<p>Number service code. If the entry in subfield OSEL is NSC, enter the required number service code for the operation to be performed on the call, as listed below:</p> <ul style="list-style-type: none"> • AIN (advanced intelligent network) • 800P (800+) • E008 (Enhanced 008) • E800 (Enhanced 800) • MAP_HLR (mobile application part home location register) • MAP_MSC (mobile application part mobile service switching center) • MAP_VLR (mobile application part visitor location register) • MAPHLR (appears only if feature AE1014 [MAP Interworking to BTUP] is on the switch) • PVN (private virtual network) • REPLDIGS (replace digits) • VPN (virtual private network)
	PFDIGS	0 to 24	<p>Number of prefix digits. If the entry in subfield OSEL is PF, datafill this refinement. Enter the number of prefix digits. If prefix digits are identified in a previous table, then this number is added to the existing value. Prefix digits are not used to index any further translation tables and are not outpulsed, but they do remain stored in call detail records (CDR).</p>

AMHEAD (continued)

XLASEL = DMOD

If the entry in subfield XLASEL is DMOD, datafill the following refinements.

Field descriptions for conditional datafill (Sheet 1 of 8)

Field	Subfield or refinement	Entry	Explanation and action
	OPT	see subfield	Options. This field is a vector consisting of up to ten options. Each option consists of subfield OSEL, and refinements that depend on the entry in subfield OSEL. For each option, specify the option selector (OSEL), followed by a space, and the refinements, each separated by a space. The entry is concluded by a \$ and datafill continues with field DFOP.
	OSEL	AFTER, CDNRTE, CGNDM, CONSUME, COODM, CPCRTE, DEL, EXTCIC, INSRT, PF, RBP, REPL, SETCDN, VPNREPL, VPNXLT, or XLT	<p>Option selector. The following options can be selected:</p> <p>Enter AFTER, followed by a space, and datafill refinement AFTER if a specific number of digits must be skipped before modifying the digit stream.</p> <p>Enter CDNRTE to route using the called number name (CDNNAME) from table CDNCHAR. If the CDNNAME is present on the incoming call or is set by the SETCDN option, translation proceeds to table CDNUXLA.</p> <p>Enter CGNDM, followed by a space, and datafill refinements PREFXCLI and INSRTCLI to remove digits from the calling line identification (CLI) and insert a datafilled digit string of up to five digits in the prefix string. The total length of the CLI and the digit string can be up to 18 digits. A modified CLI and digit string greater than 18 digits routes the call to treatment.</p> <p>Enter CONSUME, followed by a space, and datafill refinement CONDIGS to specify the number of digits that are consumed during translation.</p>

AMHEAD (continued)**Field descriptions for conditional datafill (Sheet 2 of 8)**

Field	Subfield or refinement	Entry	Explanation and action
	OSEL (continued)		<p>Enter COODM, followed by a space, and datafill refinement SERVICE to replace the dialed emergency code by the emergency number stored in table LAC.</p> <p>Note: Option selector COODM must be combined with option XLT to guarantee that translation continues with the modified number. Selector COODM cannot be combined with any other option.</p> <p>Enter CPCRTE to route using the calling party category (CPCNAME) from table CPCCHAR. If the CPCNAME is present on the incoming call, translation proceeds to table CPCUXLA.</p> <p>Enter DEL, followed by a space, and datafill refinement DELDIGS. Further digits are accepted from the agent, and overlapped outpulsing is not affected. Digits being deleted are processed before those being inserted.</p> <p>Enter EXTCIC, followed by a space, and enter data for refinements CICSIZE, SKIPDIGS, and SOURCE. The EXTCIC subfield is the external carrier identification code that indicates a long distance carrier in the global environment. This option is supported for TOPS calls.</p>

AMHEAD (continued)

Field descriptions for conditional datafill (Sheet 3 of 8)

Field	Subfield or refinement	Entry	Explanation and action
			<p>Enter INSRT, followed by a space, and datafill refinement INSRDIGS. Further digits are accepted from the agent, and overlapped outpulsing is not affected. Digits being deleted are processed before those being inserted.</p> <p>Note: Digit insertion is done in the actual digit stream, and the changes are reflected in call detail records. Replacement and insertion cannot be datafilled in the same tuple. If both options are datafilled, the second option in the tuple is used.</p> <p>Enter PF, followed by a space, and datafill refinement PFDIGS, if there are prefix digits in the digit stream.</p> <p>Enter RBP without refinements. The entry RBP is used when a call is to be marked as Ringback Price. The RBP entry in table ACCODE suffixes a hexadecimal E to the calling digits for a call that translates using a tuple with option RBP.</p> <p>Enter REPL and datafill refinement REPLDIGS. Overlapped outpulsing is disabled, and all digits are collected before continuing.</p> <p>Note: Digit replacement occurs in the actual digit stream, and the changes are reflected in call detail records. Replacement and insertion cannot be datafilled in the same tuple. If both options are datafilled, the second option in the tuple is used.</p>

AMHEAD (continued)**Field descriptions for conditional datafill (Sheet 4 of 8)**

Field	Subfield or refinement	Entry	Explanation and action
			<p>Enter SETCDN to trigger the setting of outgoing called party characteristics. This option assigns the called number name (CDNNAME) from table CDNCHAR to the call. If the CDNRTE option is subsequently encountered, the CDNNAME is used to route the call.</p> <p>You can use the SETCDN option to allow CDN routing when incoming agents such as DPNSS or BTUP are not available in table CDNCHAR.</p> <p>Enter VPNREPL to replace the called party digits with the VPN called party digits conveyed across the public network by the QSIG Feature Transparency mechanism.</p> <p>Enter VPNXLT to replace the current translation system and translation name with the values stored in table BGIDMAP. The entry to table BGIDMAP is addressed by the NNI BGID and SIGNIFICANCE information received in the originating signaling for the call.</p> <p>Note: The VPNXLT and XLT options must not both exist in the same tuple.</p> <p>Enter XLT, followed by a space, and datafill refinement XLASYS if the call proceeds to another translation system.</p>

AMHEAD (continued)

Field descriptions for conditional datafill (Sheet 5 of 8)

Field	Subfield or refinement	Entry	Explanation and action
	AFTER	0 to 29	<p>After. If the entry in subfield OSEL is AFTER, datafill this refinement. Enter the number of digits to skip before doing the modification. The default case is to calculate the new prefix fence, and replace, insert, or delete digits after the fence (for example, starting at the next digit). Option AFTER is an additional number of digits to skip before doing the modification. Option AFTER refers to the option datafilled immediately before it. For example:</p> <p>>DMOD DEL 3 AFTER 2 INSRT 11</p> <p>skips two digits, deletes the next three, and inserts digits 11 at the beginning of the digit string. The result when applied to 234567 is 23117.</p> <p>Note: Datafilling this refinement with 0 (the default value), displays the following error message:</p> <pre>Too few digits for AFTER UNSUPPORTED OPTION AT: # PROCESSING ERROR UNEXPECTED ERROR CONDITION</pre>
	CDNNAME	alphanumeric string	<p>Called number name. If the entry in subfield OSEL is SETCDN, enter data for this refinement. Enter data for this refinement to</p>
	CICSIZE	1 to 4	<p>CIC size. If the entry in subfield OSEL is EXTCIC, enter data for this refinement. This field indicates the number of digits in the CIC. This field operates on the B (called) number, so it is assumed that the switch signals the CIC as part of the B number.</p> <p>The MAP display indicates the range is 0 to 4. The system does not allow a 0 entry.</p>

AMHEAD (continued)**Field descriptions for conditional datafill (Sheet 6 of 8)**

Field	Subfield or refinement	Entry	Explanation and action
	CONDIGS	numeric (0 to 29 digits)	Consumed digits. If the entry in subfield OSEL is CONSUME, datafill this refinement. Enter a number to explicitly define the number of digits consumed during call processing.
	DELDIGS	0 to 29	Delete digits. If the entry in subfield OSEL is DEL, datafill this refinement. Enter the number of digits to be deleted, after skipping digits to be left unprocessed.
	INSRDIGS	0 to 29 digits	Insert digits. If the entry in subfield OSEL is INSRT, datafill this refinement. Enter the digits to be inserted, after skipping digits to be left unprocessed.
	INSRTCLI	1 to 5 digits or \$	Insert calling line identification. If the entry in subfield OSEL is CGNDM, datafill this refinement. Enter the new string to insert as the prefix onto the CLI. Enter \$ to specify that no digit string is inserted.
	PFDIGS	0 to 24	Number of prefix digits. If the entry in subfield OSEL is PF, datafill this refinement. Enter the number of prefix digits. If prefix digits are identified in a previous table, this number is added to the existing value. Prefix digits are not used to index any further translation tables and are not outpulsed, but they do remain stored in call detail records (CDR). Note: If refinements PF and CONSUME are both datafilled for the same tuple, only the entry for the greater of the two values is processed; the other entry is ignored.
	PREFXCLI	0 to 18	Prefix calling line identification. If the entry in subfield OSEL is CGNDM, datafill this refinement. Enter the number of prefix digits to delete.
	REPLDIGS	numeric (0 to 30 digits)	Replace digits. If the entry in subfield OSEL is REPL, datafill this refinement. Enter the digits that replace the existing digits, after skipping digits to be left unprocessed.

AMHEAD (continued)

Field descriptions for conditional datafill (Sheet 7 of 8)

Field	Subfield or refinement	Entry	Explanation and action
	SERVICE	alphanumeric (1 to 8 characters)	COODM service. If the entry in subfield OSEL is COODM, datafill this refinement. Enter the emergency service name. Emergency service names are listed in field EMRGSERV in table LAC.
	SKIPDIGS	0 to 24	Skip digits. If the entry in subfield OSEL is EXTCIC, enter data for this refinement. This field indicates the number of digits to skip before removing the carrier digits from the digit stream. This field operates on the B (called) number, so it is assumed that the system signals the CIC as part of the B number.
	SOURCE	PRESUB or DIALED	Carrier identification code source. If the entry in subfield OSEL is EXTCIC, enter data for this refinement. This field specifies the source of the CIC as follows: <ul style="list-style-type: none"> • PRESUB - presubscribed. Table TRKGRP contains the definition of the CIC. • DIALED - dialed. The subscriber enters the CIC when dialing a call.

AMHEAD (continued)**Field descriptions for conditional datafill (Sheet 8 of 8)**

Field	Subfield or refinement	Entry	Explanation and action
	XLASYS	AC, AM, CT, FA, FT, NSC, OFC, or PX	<p>Translation system. If the entry in subfield OSEL is XLT, datafill this refinement. Enter the next translation system to use, followed by a space, and datafill subfield XLANAME (the instance of the translation system).</p> <p>The choice of translation systems is as follows:</p> <ul style="list-style-type: none"> • AC (access) • AM (ambiguous) • CT (country) • FA (foreign area) • FT (utility) • NSC (number service code) • OFC (office) • PX (prefix) <p>Note: NIL is not a valid entry. NIL is only used to satisfy internal software functionality. NSC is not used in GL03.</p>
	XLANAME	alphanumeric (1 to 8 characters)	<p>Translation name. If the entry in subfield OSEL is XLT, datafill this refinement. Enter the translation name of the table within the XLASYS to which the call is routed.</p>

XLASEL = DNRTE

If the entry in subfield XLASEL is DNRTE, datafill the following refinements. Selector DNRTE allows translation to continue in table DNINV. Through this translation, calls can be terminated at directory numbers (DN) datafilled in table DNINV.

After datafilling table ACHEAD, table DNINV must be datafilled before selector DNRTE is datafilled in table ACCODE.

AMHEAD (continued)

Table AMAXLAID must be datafilled prior to selecting option AMAXLAID in field OSEL.

Field descriptions for conditional datafill (Sheet 1 of 4)

Field	Subfield or refinement	Entry	Explanation and action
	OPT	see subfield	Options. This field is a vector consisting of up to ten options. Each option consists of subfield OSEL, and refinements that depend on the entry in subfield OSEL. For each option, specify the option selector (OSEL), followed by a space, and the refinements, each separated by a space. The entry is concluded by a \$ and datafill continues with field DFOP.
	OSEL	ALLOWOVLP, AMAXLAID, CAMA, CLASS, DN, MM, PF, or SF	<p>Option selector. The following options can be selected:</p> <p>Enter ALLOWOVLP to allow overlap. This subfield does not have refinements.</p> <p>Enter AMAXLAID, followed by a space, and datafill refinement XLAID to specify an automatic message accounting (AMA) identity from within table AMAXLAID.</p> <p>Enter CAMA, followed by a space, and datafill refinement CLDFMT. The entry in CLDFMT indicates whether the international centralized AMA (ICAMA) record is generated with the originally-signaled DN or the final public switched telephone network (PSTN) number.</p>

AMHEAD (continued)

Field descriptions for conditional datafill (Sheet 2 of 4)

Field	Subfield or refinement	Entry	Explanation and action
	OSEL (continued)		<p>Enter CLASS, followed by a space, and datafill refinement CLASS if the class of the dialed digits is determined.</p> <p>Enter DN, followed by a space, and datafill refinements SNPA and OFC for the DN that the call is routed to.</p> <p>Enter MM, followed by a space, and datafill refinements MIN and MAX if the minimum and maximum dialed digits are known.</p> <p>Enter PF, followed by a space, and datafill refinement PFDIGS if there are prefix digits in the digit stream.</p> <p>Enter SF, followed by a space, and datafill refinement SFDIGS to indicate the beginning of the station code digits.</p>
	CLDFMT	CURRENT, POSTXLA	<p>Called format. If the entry in subfield OSEL is CAMA, enter either CURRENT or POSTXLA to produce the required ICAMA record format.</p> <p>If the entry is CURRENT, an ICAMA record is produced with the signaled DN (without translation).</p> <p>If the entry is POSTXLA, an ICAMA record is produced with the public switched telephone network (PSTN) number resulting from translations.</p>

AMHEAD (continued)**Field descriptions for conditional datafill (Sheet 3 of 4)**

Field	Subfield or refinement	Entry	Explanation and action
	CLASS	ATT, CNTL, COLL, DATT, EMRG, IAGRP, ICNTL, INTL, IOPRA, LCL, NATL, OPRA, RURAL, SPEC, UNKW, or URBAN	<p>Translation class. If the entry in subfield OSEL is CLASS, datafill this refinement. Enter the translation class determined by the dialed digits. This can be used for screening or billing purposes as described under CLASS in screening and charging options.</p> <ul style="list-style-type: none"> • ATT (attendant console) • CNTL (continental) • COLL (collect) • DATT (dial attendant) • EMRG (emergency) • IAGRP (interagent group) • ICNTL (intercontinental) • INTL (international) • IOPRA (international operator assisted) • LCL (local) • NATL (national) • OPRA (operator assisted) • RURAL (rural) • SPEC (special) • UNKW (unknown) • URBAN (urban)
	MAX	0 to 30	<p>Maximum digits. If the entry in subfield OSEL is MM, datafill this refinement. Enter the maximum number of digits expected. This value includes the digits used to index the current tuple and must also include the prefix digits specified in the current tuple.</p>
	MIN	0 to 30	<p>Minimum digits. If the entry in subfield OSEL is MM, datafill this refinement. Enter the minimum number of digits expected. This value includes the digits used to index the current tuple and must also include the prefix digits specified in the current tuple.</p>

AMHEAD (continued)**Field descriptions for conditional datafill (Sheet 4 of 4)**

Field	Subfield or refinement	Entry	Explanation and action
	OFC	numeric (1 to 7 digits)	Seven-digit office code. If the entry in subfield OSEL is DN, enter the office code for the DN that the call is routed to.
	PFDIGS	0 to 24	Number of prefix digits. If the entry in subfield OSEL is PF, datafill this refinement. Enter the number of prefix digits. If prefix digits are identified in a previous table, then this number is added to the existing value. Prefix digits are not used to index any further translation tables and are not outpulsed, but they do remain stored in call detail records (CDR).
	SFDIGS	0 to 29	Station fence digits. If the entry in subfield OSEL is SF, datafill this refinement. Enter a number to indicate how many digits to advance past the start of the digits that index into the tuple. During call processing, the station code digits consist of all digits beyond this indicator to the end of the dialed digits. If option SF is not datafilled, then the last four digits comprise the station code.
	SNPA	000 to 999 (3 digits)	Serving number plan area. If the entry in subfield OSEL is DN, enter the required serving number plan area (SNPA). This number must be datafilled in table HNPACONT or in table SNPANAME.
	XLAID	FREE, GENERIC1, GENERIC2, or GENERIC3	AMA translation identifier. If the entry in subfield OSEL is AMAXLAID, enter the AMA translation identifier to be used against table AMAXLAID.

AMHEAD (continued)**XLASEL = FEAT**

If the entry in field XLASEL is FEAT, datafill the following refinements.

Field descriptions for conditional datafill (Sheet 1 of 3)

Field	Subfield or refinement	Entry	Explanation and action
	OPT	see subfield	Options. This field is a vector consisting of up to ten options. Each option consists of subfield OSEL, and refinements that depend on the entry in subfield OSEL. For each option, specify the option selector (OSEL), followed by a space, and the refinements, each separated by a space. The entry is concluded by a \$ and datafill continues with field DFOP.
	OSEL	FTR, FUNC, MM, PF, or XLT	<p>Option selector. The following options can be selected:</p> <p>Enter FTR, followed by a space, and datafill refinement FTR to identify the international line feature.</p> <p>Enter FUNC, followed by a space, and datafill refinement FUNC to identify the international line feature function.</p> <p>Enter MM, followed by a space, and datafill refinements MIN and MAX if the minimum and maximum dialed digits are known.</p> <p>Enter PF, followed by a space, and datafill refinement PFDIGS if there are prefix digits in the digit stream.</p> <p>Enter XLT, followed by a space, and datafill refinement XLANAME if the translation name of the translation system is known.</p>

AMHEAD (continued)**Field descriptions for conditional datafill (Sheet 2 of 3)**

Field	Subfield or refinement	Entry	Explanation and action
	FTR	CALLBACK, CALLCHAR, CLCTDIGS, JES, NTC, VMWI, VSC or VALIDATE	<p>Feature name. If the entry in subfield OSEL is FTR, enter the refinement name shown below:</p> <ul style="list-style-type: none"> • CALLBACK (call back) • CALLCHAR (call characters) • CLCTDIGS (collect digits) • JES (Japan emergency services) • NTC (Notify Time Charges) • TLC (trunk logic circuit) • VMWI (voice mail waiting indication) • VSC (vertical service code) • VALIDATE (not used in GL03)
	FUNC	ACT, DEACT, DELETE, INTER, PROG, or USAGE	<p>Feature function code. If subfield OSEL is set to FUNC, enter one of the international line feature function codes listed below:</p> <ul style="list-style-type: none"> • ACT (activate) • DEACT (deactive) • DELETE (delete) • INTER (interrogate) • PROG (programming) • USAGE (usage)
	MAX	0 to 30	<p>Maximum digits. If the entry in subfield OSEL is MM, datafill this refinement. Enter the maximum number of digits expected following MIN entry and a space. This value includes the digits used to index the current tuple and must also include the prefix digits specified in the current tuple.</p>

AMHEAD (continued)**Field descriptions for conditional datafill (Sheet 3 of 3)**

Field	Subfield or refinement	Entry	Explanation and action
	MIN	0 to 30	Minimum digits. If the entry in subfield OSEL is MM, datafill this refinement. Enter the minimum number of digits expected. This value includes the digits used to index the current tuple and must also include the prefix digits specified in the current tuple.
	PFDIGS	0 to 24	Number of prefix digits . If the entry in subfield OSEL is PF, datafill this refinement. Enter the number of prefix digits. If prefix digits are identified in a previous table, this number is added to the existing value. Prefix digits are not used to index any further translation tables and are not outputted, but they remain stored in call detail records (CDR).

XLASEL = FEATINFO

If the entry in subfield XLASEL is FEATINFO, datafill the following refinements. Selector FEATINFO makes use of table DNSCRN to store information against DNs, which is used during call processing to determine how to proceed with the call. The screening function is triggered by selector FEATINFO in the universal translation tables. The options available with this selector are shown below.

Field descriptions for conditional datafill (Sheet 1 of 10)

Field	Subfield or refinement	Entry	Explanation and action
	FTR	CALLBACK, CALLCHAR, CLCTDIGS, JES, NTC, TLC, or VALIDATE	Feature name. Enter CALLBACK to enable originator callback during translations. Datafill subfield CALLBACK_OPTION and its refinements, then datafill subfields PFDIGS, MINDIGS, MAXDIGS, and TABREF. Enter CALLCHAR to modify all signaling characteristics. Datafill subfields CLLCHROP, PFDIGS, MINDIGS, MAXDIGS, and TABREF.

AMHEAD (continued)

Field descriptions for conditional datafill (Sheet 2 of 10)

Field	Subfield or refinement	Entry	Explanation and action
			<p>Enter CLCTDIGS to collect digits from the call originator and add them to the called digits stream for translation. Datafill subfields CLDGMIN, CLDGMAX, CLCTDIGS_OPTION, PFDIGS, MINDIGS, MAXDIGS, and TABREF.</p> <p>Enter JES to activate the Japan Emergency Service feature. Datafill refinements PFDIGS and TABREF.</p> <p>Enter NTC to notify the originating subscriber of applicable time and charges after the call terminates. Datafill subfield SUBOPT_NAME and its refinement, then datafill subfields PFDIGS, MINDIGS, MAXDIGS, and TABREF.</p> <p>Enter TLC to enable the test line call feature, which provides audible ringback tone followed by dial tone after specified durations. Datafill subfields RING_BACK_TONE_DUR, DIAL_TONE_DUR, TLC_PREFIX_DIGS, TLC_NUM_DIGS, and TLC_CHARGE.</p> <p>Enter VALIDATE, and datafill subfield VALDATOP and its refinements. Datafill subfields PFDIGS, MINDIGS, MAXDIGS, and TABREF.</p>
	CALLBACK_OPTION	CLCTDEST or NIL	<p>Callback option. If the entry in field FTR is CALLBACK, datafill this option. Enter CLCTDEST to call back the subscriber and collect destination digits. Datafill subfields CLDGMIN, CLDGMAX, DISC_ANNC_TRK, PROMPT_ANNC_TRK, and SEND_ANM. Otherwise, enter NIL.</p>
	CLDGMIN	1 to 24	<p>Minimum collected digits. Enter the minimum number of digits to be collected and entered into the called digit stream.</p>

AMHEAD (continued)**Field descriptions for conditional datafill (Sheet 3 of 10)**

Field	Subfield or refinement	Entry	Explanation and action
	CLDGMAX	1 to 24	Maximum collected digits. Enter maximum number of digits to be collected and written into the called digit stream. The value cannot be less than CLDGMIN.
	DISC_ANNC_TRK	alphanumeric (1 to 16 characters)	Disconnect announcement trunk. Enter trunk common language location identifier (CLLI).
	PROMPT_ANNC_TRK	alphanumeric (1 to 16 characters)	Prompt announcement trunk. Enter trunk the common language location identifier (CLLI).
	SEND_ANM	Y or N	Send answer message. Enter Y (yes) or N (no).
	CLLCHROP	NOCHGMSG or EARLYCPG	Call characteristics. If the entry in field FTR is CALLCHAR, datafill this option. Enter NOCHGMSG to block backward CHG message. Enter EARLYCPG to specify that a call progress (CPG) message is issued in the backwards direction before an address complete message (ACM) is sent. The CPG message is permitted before an ACM in certain ISDN user part (ISUP) variants to establish a bidirectional speech path and to stop the T7 timer.
	CLCTDIGS_OPTION	NIL or \$	Collect digits option. If the entry in field FTR is CLCTDIGS, datafill this option. Enter NIL or enter \$ to proceed to the next option.
	SUBOPT_NAME	DUR_ADJ	Suboption name. If the entry in field FTR is NTC, datafill this option. Enter DUR_ADJ to specify the duration adjustment for NTC and datafill subfield DURATION_ADJ.
	DURATION_ADJ	0 to 99	Duration adjustment. Enter the time in seconds.

AMHEAD (continued)**Field descriptions for conditional datafill (Sheet 4 of 10)**

Field	Subfield or refinement	Entry	Explanation and action
	RING_BACK_TONE_DUR	1 to 255	Ringback tone duration. If the entry in field FTR is TLC, datafill this option. Enter the time, in seconds, that ringback tone is provided to the originator.
	DIAL_TONE_DUR	1 to 255	Dial tone duration. If the entry in field FTR is TLC, datafill this option. Enter the time, in seconds, that dial tone is provided to the originator.
	TLC_PREFIX_DIGS	0 to 18	Prefix digits in called number. If the entry in field FTR is TLC, datafill this option. Enter the number of digits to advance the prefix fence to detect the charge message digits when CPC = PAYPHONE.
	TLC_NUM_DIGS	numeric(3 or 4) Japan only	Test line call number of digits. Enter the number of dialed digits to be transferred to the NCCI#7 CHG message. This is also the number of digits stored in the LMNNUM field of the SMDR #DE record.
	TLC_CHARGE	Y or N	Test line call charge indicator. The TLC_CHARGE field indicates the billing status of an ISUP test call. Enter Y if the call is billable. Enter N if the call is not billable. The default value for this field is N.
	OPT	see subfield VALDATOP	Options. If the entry in field FTR is VALIDATE, datafill this option. This field is a vector consisting of up to five options. Each option consists of subfield VALDATOP, and refinements that depend on the entry in subfield VALDATOP. For each option, specify VALDATOP, followed by a space, then the refinements, each separated by a space. The entry is concluded by a \$ and datafill continues with field DFOP.

AMHEAD (continued)

Field descriptions for conditional datafill (Sheet 5 of 10)

Field	Subfield or refinement	Entry	Explanation and action
	VALDATOP	BCSCRN, CALLED, CLDTCOLG, CLISERV, CUSTMOD, LCASCRN, NOCHARGE, PRESEL, SCRNLNTH, SUBSCRN, TCNOTSCR, THIRDPTY, VERDEST, V3PTYBIL	<p>Validate option. Enter a list of up to five options. The options specify what characteristics are to be considered when screening the call. Enter \$ to signify the end of the list.</p> <p>Note: Selector VALIDATE is traversed only once for each call.</p> <p>Enter BCSCRN and datafill refinement BCOPTS to identify the bearer capability name.</p> <p>Enter CALLED to indicate the number to be used for screening. The SUBSCRN options are used to specify the subscriber types allowed to receive the call.</p> <p>Note: When using option CALLED, there must be no further digit manipulation after selector VALIDATE is encountered in translations.</p> <p>If option CALLED is not entered, then the calling party number is used for screening and the SUBSCRN options are used to specify the subscriber types allowed to make the call.</p> <p>Note: Pay phone subscribers are treated as general subscribers if option CALLED is specified.</p> <p>Enter CLDTCOLG, followed by a space, to copy digits from the called to the calling digit stream, and datafill options OFFSET and COUNT.</p> <p>Enter CLISERV, followed by a space, and enter data for refinement SERVNAME to add the name of the service provider.</p>

AMHEAD (continued)

Field descriptions for conditional datafill (Sheet 6 of 10)

Field	Subfield or refinement	Entry	Explanation and action
			<p>Enter CUSTMOD, followed by a space, to alter the internal network class of service (NCOS) and customer group to new value for a given directory number (DN) based on the CUSTINFO attribute in table DNSCRN. The source of the DN used as an index into table DNSCRN is determined by the VALIDATE datafill. Datafill refinement CUSTSCRN.</p> <p>Enter LCASCRN, followed by a space, to enable local calling area screening. The called and calling numbers are checked against tables LCARNAME and LCASCRCN to determine if the numbers are local to each other, and whether the call should be denied or allowed to continue routing.</p> <p>Enter NOCHARGE, followed by a space, to indicate that the call is nonbillable.</p> <p>Note: If both NOCHARGE and THIRDPTY options are specified, NOCHARGE takes precedence.</p> <p>Enter PRESEL to allow screening for the PRESEL attribute in table DNSCRN.</p> <p>Enter SCRNLNTH, followed by a space, and datafill refinement MINLNTH to specify the minimum length of the number being screened.</p> <p>Enter SUBSCRN, followed by a space, and datafill up to three multiples of the following subscriber types: GENERAL, PAYPHONE, PERSONAL, and MOBILE. Enter \$ after entering SUBSCRN to indicate that no subscriber types are permitted to make or receive the call.</p> <p>Enter TCNOTSCR to indicate that calls with CPC set to Test Call are not screened.</p>

AMHEAD (continued)

Field descriptions for conditional datafill (Sheet 7 of 10)

Field	Subfield or refinement	Entry	Explanation and action
			<p>Enter THIRDPY to indicate that automatic third party billing is used. Table DNSCRN is checked for attribute UNPAID.</p> <p>Note: If both NOCHARGE and THIRDPY options are specified, NOCHARGE takes precedence.</p> <p>Note: Payphone subscribers are treated as general subscribers if option CALLED is specified.</p> <p>Enter VERDEST to verify the destination of a call. Called digits are checked against ADDCODE entries in table DNSCRN.</p> <p>Enter V3PTYBIL to verify third party billing. Called digits are checked against table DNSCRN to determine authorization and account status.</p> <p>Note: NIL appears on the switch range but is not a valid entry. The value NIL is used only to satisfy internal software requirements.</p>
	BCOPTS	alphanumeric (1 to 8 characters)	Bearer capability option. If the entry in field VALDATOP is BCSCRN, datafill this refinement. Enter up to four bearer capability names.
	COUNT	0 to 30	If the entry in field VALDATOP is CLDTCCLG, enter subfield COUNT to count the digits from the called stream to the calling stream.

AMHEAD (continued)**Field descriptions for conditional datafill (Sheet 8 of 10)**

Field	Subfield or refinement	Entry	Explanation and action
	CUSTSCRN	Y or N	<p>Customer screen. Enter Y to block calls that are not subscribed to the switched on-net services if attempting a switched on-net call. If the DN being screened is not present in table DNSCRN, the call is rejected with the Call Not Allowed (CNAD) treatment. The internal NCOS and CUSTGRP associated with the call are altered to the values found in the CUSTINFO attribute if present for the given DN in table DNSCRN. The DN used to index table DNSCRN can be the subscriber calling line identification (CLI) or the dialed number. The source of the DN is determined by the datafill of field VALIDATE.</p> <p>Enter N if no screening is performed.</p> <p>Note: The FEATINFO values CCANN, CCARD, CCSDT, DAFOP, FAXSUP, FAXTEST, INBFAX, INBFD, INTLFD, ISD, ISDTST, ISDVRE, OUTBFAX, OUTBFD, PB3RDPTY, PBCALL, PBISSD, PBISSDVRE, and PBTST are valid only in DMS-250 switching offices. Additional DMS-250 parameters are listed in the DMS-250 specific data schema NTPs.</p>
	MINLNTH	0 to 18 values from 0 to 30 are possible in APC software loads	Minimum length. If the entry in field VALDATOP is SCRNLNTH, enter the minimum number of digits required in number being screened.
	OFFSET	0 to 30	If the entry in field VALDATOP is CLDTCGLG, enter subfield OFFSET to offset the digits from the called stream to the calling stream.
	SERVNAME	alphanumeric string	Service provider name. If the entry in field VALDATOP is CLISERV, enter the name of the service provider in this refinement.
	SUBSCTYP	GENERAL, PAYPHONE, PERSONAL, or MOBILE	Subscriber type. Enter subscriber type, followed by a space, and datafill refinements WHITLIST, CHKBLKCL, CHKUNPD, and CHKCCR. This option allows you to specify which subscriber types are permitted to make or receive a call and whether the subscriber's standing is important for a call.

AMHEAD (continued)**Field descriptions for conditional datafill (Sheet 9 of 10)**

Field	Subfield or refinement	Entry	Explanation and action
	WHITLIST	Y or N	Whether it list. Enter Y (yes) to indicate that the subscriber's directory number must be datafilled in table DNSCRN. Otherwise, enter N (no).
	CHKBLKCL	Y or N	Check block call. Enter Y to check if the subscriber has subscribed to all services for which this tuple is being used (BLKCALL attribute in table DNSCRN). Otherwise, enter N.
	CHKUNPD	Y or N	Check unpaid. Enter Y to check if the subscriber has paid his bills. Otherwise, enter N.
	CHKCCR	Y or N	Check cumulative call restriction. Enter Y to check the subscriber's cumulative charge limit. Otherwise, enter N.
	PFDIGS	0 to 24	Prefix digits. Enter the number of prefix digits present at this point in the call. Prefix digits are not used to index any further translation tables and are not outpulsed, but they remain stored in call detail records (CDR).
	MINDIGS	0 to 30	Minimum digits. Enter the minimum number of digits expected. This value includes the digits used to index the current tuple and must also include the prefix digits specified in the current tuple.
	MAXDIGS	0 to 30	Maximum digits. Enter the maximum number of digits expected. This value includes the digits used to index the current tuple and must also include the prefix digits specified in the current tuple.
	TABREF	see subfields	Table reference. This field consists of subfields XLASYS and XLANAME.

AMHEAD (continued)**Field descriptions for conditional datafill (Sheet 10 of 10)**

Field	Subfield or refinement	Entry	Explanation and action
	XLASYS	AC, AM, CT, FA, FT, NSC, OFC, or PX	<p>Translation system. Enter the next translation system to use, followed by a space, and datafill subfield XLANAME (the instance of the translation system).</p> <p>The choice of translation systems is as follows:</p> <ul style="list-style-type: none"> • AC (access) • AM (ambiguous) • CT (country) • FA (foreign area) • FT (utility) • NSC (number service code) • OFC (office) • PX (prefix) <p>Note: NIL is not a valid entry. NIL is used only to satisfy internal software functionality.</p>
	XLANAME	alphanumeric (1 to 8 characters)	Translation name. Enter the translation name of the table instance within the XLASYS to which the call is routed.

XLASEL = HRC

If the entry in subfield XLASEL is HRC, datafill the following refinements.

Field descriptions for conditional datafill (Sheet 1 of 2)

Field	Subfield	Entry	Explanation and action
	OPT	see subfield	Options. This field contains subfield OSEL, and refinements that depend on the entry in subfield OSEL. The entry is concluded by a \$ and datafill continues with field DFOP.
	OSEL	PFBILL, XLT	Option selector. If the call proceeds to another translation system, enter XLT, followed by a space, and datafill refinement XLASYS. Also complete an entry for option selector PFBILL.

AMHEAD (continued)

Field descriptions for conditional datafill (Sheet 2 of 2)

Field	Subfield	Entry	Explanation and action
	XLASYS	AC, AM, CT, FA, FT, NSC, OFC, PX	<p>Translation system. If option selector XLT is entered in subfield OSEL, datafill this refinement. Enter the next translation system to use, followed by a space, then datafill refinement XLANAME. Enter one of the following:</p> <ul style="list-style-type: none"> • AC (access) • AM (ambiguous) • CT (country) • FA (foreign area) • FT (utility) • NSC (number service code) • OFC (office) • PX (prefix) <p>Note: NIL is not a valid entry. NIL is used only to satisfy internal software functionality. NSC is not used in GL03.</p>
	XLANAME	alphanumeric (1 to 8 characters)	Translation name. If XLT is entered in subfield OSEL, datafill this refinement. Enter the translation name of the table within the XLASYS to which the call is routed.
	PFBILL	Y or N	Prefix billing option. Enter PFBILL, followed by a space, and then enter either Y or N. If "Y" is entered, the home routing code specified in the tuple is included in the billing record. If "N" is entered, the home routing code is not included in billing records.

AMHEAD (continued)**XLASEL = IAC**

If the entry in subfield XLASEL is IAC, datafill the following refinements.

1xxxField descriptions for conditional datafill

Field	Subfield or refinement	Entry	Explanation and action
	OPT	see subfield	Options. This field is a vector list consisting of up to ten options. Each option consists of subfield OSEL, and refinements that depend on the entry in subfield OSEL. The entry is concluded by a \$ and datafill continues with field DFOP.
	OSEL	PF	Option selector. Enter PF, followed by a space, and datafill refinement PFDIGS, if there are prefix digits in the digit stream.
	PFDIGS	0 to 24	Number of prefix digits. If the entry in subfield OSEL is PF, datafill this refinement. Enter the number of prefix digits. If prefix digits are identified in a previous table, then this number is added to the existing value. Prefix digits are not used to index any further translation tables and are not outputted, but they remain stored in call detail records (CDR).

XLASEL = RTE

If the entry in subfield XLASEL is RTE, datafill the following refinements.

AMHEAD (continued)

Table AMAXLAID must be datafilled prior to selecting option AMAXLAID in field OSEL.

Field descriptions for conditional datafill (Sheet 1 of 15)

Field	Subfield or refinement	Entry	Explanation and action
	OPT	see subfield	Options. This field is a vector consisting of up to ten options. Each option consists of subfield OSEL, and refinements that depend on the entry in subfield OSEL. For each option, specify the option selector (OSEL), followed by a space, and the refinements, each separated by a space. The entry is concluded by a \$ and datafill continues with field DFOP.
	OSEL	ACF, AMAXLAID, BLKOVLP, CALLCTRL, CAMA, CDN, CDNRTE, CLASS, CONSUME, CPCRTE, CPMCALL, DDIDX, DEST, EXTCIC, IAA, LNET, MM, MZONE, NETSRV, PCC, PF, PIP, PNRF, PRESEL, PRESELRTE PRIVL, QFT, SETCDN, TOC, VPN, or VPNPAN	Option selector. The following options can be selected: Enter ACF, followed by a space, and datafill refinement ACF, if the area code fence is defined. Enter AMAXLAID, followed by a space, and datafill refinement XLAID, to specify an automatic message accounting (AMA) identity from within table AMAXLAID. Enter BLKOVLP to prevent calls from being outpulsed until all CDN digits are collected. This subfield does not have refinements. Enter CALLCTRL, followed by a space, and datafill refinement CALLCTRL. The entry in refinement CALLCTRL indicates who has control of the call: the calling party, the called party, or both.

AMHEAD (continued)**Field descriptions for conditional datafill (Sheet 2 of 15)**

Field	Subfield or refinement	Entry	Explanation and action
			<p>Enter CAMA, followed by a space, and datafill refinement CLDFMT. The entry in refinement CLDFMT indicates whether the international centralized automatic message accounting (ICAMA) record is generated with either the originally signaled directory number (DN) or the final public switched telephone network (PSTN) number.</p> <p>Enter CDN, followed by a space, and datafill refinement CDN to select the nature of address field. This field is used to identify the called party of the initial address message (IAM). It is used for Australian ISDN user part (AISUP) call translations.</p> <p>Enter CDNRTE to route using the called number name (CDNNAME) from table CDNCHAR. If the CDNNAME is present on the incoming call or is set by the SETCDN option, translation proceeds to table CDNUXLA.</p> <p>Enter CLASS, followed by a space, and datafill refinement CLASS, if the class of the dialed digits is determined.</p> <p>Enter CONSUME, followed by a space, and datafill refinement CONDIGS, to specify the number of digits that are consumed during translation.</p> <p>Enter CPCRTE to route using the calling party category (CPCNAME) from table CPCCHAR. If the CPCNAME is present on the incoming call, translation proceeds to table CPCUXLA.</p> <p>Enter CPMCALL, followed by a space, and datafill refinement CPMCALL, to specify call billing against the called party instead of the calling party for intraoffice calls.</p>

AMHEAD (continued)**Field descriptions for conditional datafill (Sheet 3 of 15)**

Field	Subfield or refinement	Entry	Explanation and action
			<p>Enter DDIDX, followed by a space, and enter data for refinement DDIDX. Enter data for this subfield if a destination discount applies to the call.</p> <p>Enter DEST, followed by a space, and datafill refinement DEST, the index into the route table of the current XLASYS and XLANAME.</p> <p>Enter EXTCIC, followed by a space, and enter data for refinements CICSIZE, SKIPDIGS, and SOURCE. This subfield indicates the external carrier identification code.</p> <p>Enter IAA and the datafill refinement IAA_INDEX to generate or modify IAA message parameters based on datafill in table IAACtrl.</p> <p>Enter LNET, followed by a space, and datafill refinement LNET, the index into table LNETWORK, to find the international metering system tariff for the call.</p>

AMHEAD (continued)**Field descriptions for conditional datafill (Sheet 4 of 15)**

Field	Subfield or refinement	Entry	Explanation and action
			<p>Enter MM, followed by a space, and datafill refinements MIN and MAX, if the minimum and maximum number of expected digits dialed are known. These values include the digits used to index the current tuple and must also include the prefix digits specified in the current tuple.</p> <p>Note: For fast interdigital timing to function properly, MM can only be used with the RTE selector whenever the value in refinement MIN is not equal to the value in refinement MAX.</p> <p>In other words, if MIN=MAX, MM can be used with the CONT selector in table PXCOD; if the value in refinement MIN is not equal to the value in refinement MAX, MM cannot be used until the RTE selector is used (which is usually in either table FACOD or table OFCCOD).</p> <p>If refinements MIN and MAX are set in table PXCOD when they are not equal to each other, partial dial timing is used after MIN digits are dialed in order to determine the end of dialing.</p> <p>Enter MZONE, followed by a space, and datafill refinement MZONE, if metering is done on the call.</p> <p>Enter NETSRV and datafill refinement NETSRV_NAME to indicate a Japan network service.</p> <p>Enter PCC, followed by a space, and datafill refinement PCCDR, if a pseudo country code is required.</p>

AMHEAD (continued)

Field descriptions for conditional datafill (Sheet 5 of 15)

Field	Subfield or refinement	Entry	Explanation and action
			<p>Enter PF, followed by a space, and datafill refinement PFDIGS, the prefix fence. This is the number of prefix digits associated with this tuple (that is, if some prefix digits were identified in a previous table, then the number here is added to the existing value). Prefix digits are not used to index any further translation tables and are not outpulsed, but they remain stored in call detail records (CDR).</p> <p>Enter PIP, followed by a space, to perform a residency check for the digits being translated. The residency check is used by the local number portability feature to ensure that calls to DNs that have been ported into the office are not routed out of the office.</p> <p>Note: You must complete entries in fields MIN and MAX before entering the PIP option.</p> <p>Enter PNRF to invoke the ported number recognition function, which is used for LNP applications in Germany. The PNRF option does not require any subfields.</p> <p>Enter PRESEL, followed by a space, and datafill refinement PRESEL to provide the necessary information used to index into the PCIXLA table.</p> <p>Enter PRESELRTE, followed by a space, and datafill refinement PRESELRTE, the index into the route table of the current XLASYS and XLANAME.</p> <p>Enter PRIVL, followed by a space, and datafill refinement PRIVL, if the user is a privileged user (for example, operators).</p>

AMHEAD (continued)

Field descriptions for conditional datafill (Sheet 6 of 15)

Field	Subfield or refinement	Entry	Explanation and action
			<p>Enter QFT followed by ON or OFF to indicate if an outgoing route is capable of QSIG Feature Transparency.</p> <p>Note: The QFT ON option must not be added to a route unless the far-end node is QFT-capable.</p> <p>Enter SETCDN to trigger the setting of outgoing called party characteristics. This option assigns the called number name (CDNNAME) from table CDNCHAR to the call. If the CDNRTE option is subsequently encountered, the CDNNAME is used to route the call.</p> <p>You can use the SETCDN option to allow CDN routing when incoming agents such as DPNSS or BTUP are not available in table CDNCHAR.</p> <p>Enter TOC, followed by a space, and datafill refinement CHG for the type of charge where the type of charge messaging is to be selected.</p> <p>Enter VPN, followed by a space, and datafill refinements ONNET and BILLABLE if the call routes through a service switching point (SSP) and feature package NTXH49AA or NTXH49AB (VPN-SSP) is in the switching unit.</p> <p>Enter VPNPAN to indicate that the PINX is to act as the PAN for an outgoing route.</p> <p>Note: If VPNREPL or VPNXLT have been entered in the DMOD selector, the VPNPAN option is redundant.</p>
	ACF	0 to 29	<p>Area code fence. If the entry in subfield OSEL is ACF, datafill this refinement. Enter the number of digits between the beginning of the digits to currently index the table, and the end of the area code.</p>

AMHEAD (continued)

Field descriptions for conditional datafill (Sheet 7 of 15)

Field	Subfield or refinement	Entry	Explanation and action
	BILLABLE	Y or N	<p>Virtual private network billable call. If the entry in subfield OSEL is VPN, enter Y if an automatic message accounting (AMA) record is required for each VPN call. Otherwise, enter N.</p> <p>An AMA record is not generated if an address complete message (ACM) of address complete, no charge is returned, or if the call terminates in the SSP on a line with the free number terminating (FNT) option.</p>
	CALLCLASS	PRESELECT OVERRIDE CSNTRUNK, FLEXCHG_ VALUE, CHGIND, ISUPPREF	<p>Preselection call processing. If the entry in subfield OSEL is PRESEL, datafill this refinement. Enter the preselection call class type that is associated with the call.</p> <p>Note: Calltype CSN and TRUNK are available under the PRESEL option. These call classes are not needed for German Carrier Selection, and are not supported. The same applies to the Continue option of CONT. For the German market only NOCONT is supported.</p>

AMHEAD (continued)**Field descriptions for conditional datafill (Sheet 8 of 15)**

Field	Subfield or refinement	Entry	Explanation and action
	CALLCTRL	CALLED, CALLING, LAST, or MUTUAL	<p>Call control. If the entry in subfield OSEL is CALLCTRL, datafill this refinement. Enter one of the following values to specify the party controlling the call:</p> <ul style="list-style-type: none"> • If the entry is CALLED and the called line goes on-hook first, the call is released immediately. If the calling line goes on-hook first and does not reanswer, the connection is not released until the called line goes on-hook. There are no time-outs, and the calling party is allowed to reanswer until the called line goes on-hook. Calls to lines with option ESG must have CALLCTRL(CALLED). Calls terminating on an ITOPS position must have CALLCTRL(CALLED). • If the entry is CALLING and the calling line goes on-hook first, the call is released immediately. If the called line goes on-hook first, the called party is allowed to reanswer within a datafilled reanswer time-out or until the calling line goes on-hook. If the time-out expires or if the calling line goes on-hook, the calling party releases the call and the called line is set to idle. • If the entry is LAST, the call is released when the later of the called party or the calling party goes on-hook. If either party goes on-hook, that party is allowed to reanswer within a datafilled reanswer time-out or until both parties go on-hook. • If the entry is MUTUAL and either line goes on-hook, the call is released immediately.
	CDNNAME	alphanumeric string	Called number name. If the entry in subfield OSEL is SETCDN, enter data for this refinement to route the call using the called number name from table CDNCHAR.

AMHEAD (continued)**Field descriptions for conditional datafill (Sheet 9 of 15)**

Field	Subfield or refinement	Entry	Explanation and action
	CHG	SEND_ CHARGE or SEND_NO_ CHARGE	Charge. If the entry in subfield OSEL is TOC, enter SEND_CHARGE to set the answer message (BTUP ANM) type of answer (TOA) string sent out from a node to SEND_CHARGE. Enter SEND_NO_CHARGE to set the answer message (BTUP ANM) type of answer (TOA) string sent out from a node to SEND_NO_CHARGE.
	CICSIZE	1 to 4	CIC size. If the entry in subfield OSEL is EXTCIC, enter data for this refinement. This field indicates the number of digits in the CIC. This field operates on the B (called) number, so it is assumed that the switch signals the CIC as part of the B number. The MAP display indicates the range is 0 to 4. The system does not allow a 0 entry.

AMHEAD (continued)**Field descriptions for conditional datafill (Sheet 10 of 15)**

Field	Subfield or refinement	Entry	Explanation and action
	CLASS	ATT, CNTL, COLL, DATT, EMRG, IAGRP, ICNTL, INTL, IOPRA, LCL, NATL, OPRA, RURAL, SPEC, UNKW, or URBAN	<p>Translation class. If the entry in subfield OSEL is CLASS, enter the translation class determined by the dialed digits. This can be used for screening or billing as described under CLASS in screening and charging options.</p> <p>The translation classes are defined as follows:</p> <ul style="list-style-type: none"> • ATT (attendant console) • CNTL (continental) • COLL (collect) • DATT (dial attendant) • EMRG (emergency) • IAGRP (interagent group) • ICNTL (intercontinental) • INTL (international) • IOPRA (international operator assisted) • LCL (local) • NATL (national) • OPRA (operator assisted) • RURAL (rural) • SPEC (special) • UNKW (unknown) • URBAN (urban)
	CLDFMT	CURRENT, POSTXLA	<p>Called format. If the entry in subfield OSEL is CAMA, enter either CURRENT or POSTXLA to produce the required ICAMA record format.</p> <p>If the entry is CURRENT, an ICAMA record is produced with the signaled DN (without translation).</p> <p>If the entry is POSTXLA, an ICAMA record is produced with a PSTN number resulting from translations.</p>

AMHEAD (continued)**Field descriptions for conditional datafill (Sheet 11 of 15)**

Field	Subfield or refinement	Entry	Explanation and action
	CONDIGS	numeric (0 to 29 digits)	Consumed digits. If the entry in subfield OSEL is CONSUME, datafill this refinement. Enter a number to explicitly define the number of digits consumed during call processing.
	CONTINUE	CONT, NOCONT	Continue. If the entry in subfield OSEL is PRESEL, enter data for this refinement. Enter CONT to continue with the current translations system. Enter NOCONT to stop translations.
	CPMCALL	Y or N	Called party metering. If the entry in subfield OSEL is CPMCALL, enter Y (yes) if calls are billed against the called party for intraoffice calls. Enter N (no) for the default value of billing against the calling party for intraoffice calls.
	DDIDX	1 to 63 or DEFAULT	Destination discount index. If the entry in subfield OSEL is DDIDX, enter data for this refinement to apply the destination discount to the call.
	DEST	0 to 1023	Destination route list index. If the entry in subfield OSEL is DEST, enter the number in the route list, of the same translation system, that the call is routed to.
	IAA_INDEX	0 to 1024	Interadministration accounting index. If the entry in subfield OSEL is IAA, datafill this refinement. Enter the value that indexes the corresponding tuple in IACTRL.
	LNET	alphanumeric (1 to 16 characters)	Logical network. If the entry in subfield OSEL is LNET, enter the logical network name that the call is on. The logical network name must be previously datafilled in table LNETWORK. The entry in this field is used by the international metering system to determine a tariff for the call.

AMHEAD (continued)**Field descriptions for conditional datafill (Sheet 12 of 15)**

Field	Subfield or refinement	Entry	Explanation and action
	MAX	0 to 30	Maximum digits. If the entry in subfield OSEL is MM, datafill this refinement. Enter the maximum number of digits expected. This value includes the digits used to index the current tuple and must also include the prefix digits specified in the current tuple.
	MIN	0 to 30	Minimum digits. If the entry in subfield OSEL is MM, datafill this refinement. Enter the minimum number of digits expected. This value includes the digits used to index the current tuple and must also include the prefix digits specified in the current tuple.
	MZONE	0 to 63	Metering zone. If the entry in subfield OSEL is MZONE, enter the metering zone of the call, in the logical network as defined by selector LNET. The entry in this field is used by the international metering system to determine a tariff for the call.

AMHEAD (continued)**Field descriptions for conditional datafill (Sheet 14 of 15)**

Field	Subfield or refinement	Entry	Explanation and action
	ONNET	Y or N	<p>Call on virtual private network. If the entry in subfield OSEL is VPN, enter Y if the call stays within the defined virtual private network. Otherwise enter N.</p> <p>Overlapped outpulsing is only supported on off-network calls. Calls processed without subfield ONNET set to Y are off-network calls. Meridian Digital Centrex (MDC) calls are treated as off-network calls, and therefore overlapped outpulsing is supported for MDC calls.</p>
	PCCDR	0 to 9, B, C, D, E (1 to 3 digits)	<p>Pseudo country code digits. If the entry in subfield OSEL is PCC, enter the three-digit pseudo country code (PCC). If a two-digit PCC is required, it must be padded by a leading zero.</p> <p>The pseudo country code is used to record a particular pseudo country code. This can be extracted for use by system logic later, for example, two-stage outpulsing.</p>
	PFDIGS	0 to 24	<p>Number of prefix digits. If the entry in subfield OSEL is PF, datafill this refinement. Enter the number of prefix digits. If prefix digits are identified in a previous table, this number is added to the existing value. Prefix digits are not used to index any further translation tables and are not outpulsed, but they remain stored in call detail records (CDR).</p> <p>Note: If refinements PF and CONSUME are both datafilled for the same tuple, only the entry for the greater of the two values is processed; the other entry is ignored.</p>
	PFXAMA	0 to 4 digits, or N	<p>Called party number prefix in AMA. If NOA is set to NTL, datafill PFXAMA with 0011.</p> <p>If NOA is set to NATL, datafill PFXAMA with 0.</p> <p>If NOA is set to LOCAL or NET, datafill PFXAMA with N.</p>

AMHEAD (continued)**Field descriptions for conditional datafill (Sheet 15 of 15)**

Field	Subfield or refinement	Entry	Explanation and action
	PRIVL	Y or N	Privileged user. If the entry in subfield OSEL is PRIVL, enter Y (yes), if the user is a privileged user (for example, operator). Otherwise, enter N (no).
	SKIPDIGS	0 to 24	Skip digits. If the entry in subfield OSEL is EXTCIC, enter data for this refinement. This field indicates the number of digits to skip before removing the carrier digits from the digit stream. This field operates on the B (called) number, so it is assumed that the system signals the CIC as part of the B number.
	SOURCE	PRESUB or DIALED	Carrier identification code source. If the entry in subfield OSEL is EXTCIC, enter data for this refinement. This field specifies the source of the CIC as follows: <ul style="list-style-type: none"> • PRESUB - presubscribed. Table TRKGRP contains the definition of the CIC. • DIALED - dialed. The subscriber enters the CIC when dialing a call.
	STOPRTMR	Y or N	Stop remote timer. Enter Y (yes) to disable the address complete message (ACM) timer of the remote switch. Default is N (no).
	XLAID	FREE, GENERIC1, GENERIC2, or GENERIC3	AMA translation identifier. If the entry in subfield OSEL is AMAXLAID, enter the AMA translation identifier to be used against table AMAXLAID.

XLASEL = TRMT

If the entry in subfield XLASEL is TRMT, datafill the following refinements.

AMHEAD (continued)

Route to the specified treatment. A treatment is a known exception or failure condition. The action taken terminates translation, returning an indication that a treatment was encountered and decoded into a route.

Field descriptions for conditional datafill

Field	Subfield or refinement	Entry	Explanation and action
	OPT	see subfield	Options. This field is a vector consisting of up to ten options. Each option consists of subfield OSEL, and refinements that depend on the entry in subfield OSEL. For each option, specify the option selector (OSEL), followed by a space, and the refinements, each separated by a space. The entry is concluded by a \$ and datafill continues with field DFOP.
	OSEL	OFC	Option selector. Enter OFC, followed by a space, and datafill refinement OFC, if a treatment name is required.
	OFC	alphanumeric (1 to 4 characters)	Office treatment. Enter a treatment name that is contained in the office treatment subtable, TMTCNTL.TREAT.

XLASEL = all entries

Table AMAXLAID must be datafilled prior to selecting option AMAXLAID in field OSEL.

AMHEAD (continued)

For all entries in subfield XLASEL, datafill the following refinements.

Field descriptions for conditional datafill (Sheet 1 of 16)

Field	Subfield or refinement	Entry	Explanation and action
	DFOP	DFOP or NODFOP	<p>Default options . Enter DFOP and datafill subfield OSEL and its refinements.</p> <p>The default options only apply if a tuple with field XLASEL set to RTE or CONT is chosen in code table.</p> <p>If the entry in field DFOP is equal to DFOP, this field is a vector that consists of a number of options. Each option, consisting of subfield OSEL and refinements dependent on the entry in subfield OSEL, is separated from the next by a space. The various refinements are described in subfield OSEL. For each option, specify the option selector, followed by a space, and the refinements, with each refinement separated from the next by a space. The entry is concluded by a \$ and datafill continues with field CON.</p> <p>Enter NODFOP if there are no default options and datafill field CON.</p>
	DFOP (continued)		<p>In the case of the dialed digits resolving into an RTE or CONT selector, any options not datafilled against the digits can be defaulted to the value specified here. This facility, and option DFLT, are intended to minimize the amount of datafill required in any given code table, especially if most of the expected codes have the same attributes. If an option is applicable to most, but not all, tuples in the code table instance, the option can still be datafilled in the default options. Options datafilled in the code table tuples override the options in the head table, so the different value can be datafilled into those few code tuples to which the default option does not apply.</p>

AMHEAD (continued)

Field descriptions for conditional datafill (Sheet 2 of 16)

Field	Subfield or refinement	Entry	Explanation and action
	OSEL	ACF, AMAXLAID, CALLCTRL, CAMA, CDN, CDNRTE, CLASS, CLIOVRD, CONSUME, CPCRTE, CPMCALL, DDIDX, DEST, EXTCIC, IAA, LNET, MM, MZONE, NETSRV, PCC, PF, PNRF, PRESEL, PRIVL, QFT, SETCDN, TELETAXE, TOC, VPN, or XLT	<p>Option selector. The following options can be selected:</p> <p>Enter ACF, followed by a space, and datafill refinement ACF if the area code fence is defined.</p> <p>Enter AMAXLAID, followed by a space, and datafill refinement XLAID to specify an automatic message accounting (AMA) identity from within table AMAXLAID.</p> <p>Enter CALLCTRL, followed by a space, and datafill refinement CALLCTRL. The entry in refinement CALLCTRL indicates who has control of the call: the calling party, the called party, or both.</p> <p>Enter CAMA, followed by a space, and datafill refinement CLDFMT. The entry in CLDFMT indicates whether the international automatic message accounting (ICAMA) record is generated with the the originally signaled directory number (DN) or the final public switched telephone network (PSTN) number.</p> <p>Enter CDN, followed by a space, and datafill refinement CDN to select the nature of address field. This field is used to identify the called party of the initial address message (IAM). It is used for Australian ISDN user part (AISUP) call translations.</p> <p>Enter CDNRTE to route a call using the called number name (CDNNAME) from table CDNCHAR. If the CDNNAME is present on the incoming call or is set by the SETCDN option, translation proceeds to table CDNUXLA. The CDNRTE option does not have refinements.</p> <p>Enter CLASS, followed by a space, and datafill refinement CLASS if the class of the dialed digits can be determined.</p>

AMHEAD (continued)**Field descriptions for conditional datafill (Sheet 3 of 16)**

Field	Subfield or refinement	Entry	Explanation and action
	OSEL (continued)		<p>Enter CLIOVRD, followed by a space, and enter data for refinement CLIOVRD. This subfield indicates calling line identity override.</p> <p>Enter CONSUME, followed by a space, and datafill refinement CONDIGS to specify the number of digits that are consumed during translation.</p> <p>Enter CPCRTE to route the call using the calling party category (CPCNAME) from table CPCCHAR. If the CPCNAME is present on the incoming call, translation proceeds to table CPCUXLA. The CPCRTE option does not have refinements.</p> <p>Enter CPMCALL, followed by a space, and datafill refinement CPMCALL to specify call billing against the called party instead of the calling party for intraoffice calls.</p> <p>Enter DDIDX, followed by a space, and enter data for refinement DDIDX. This option indicates a destination discount applies to the call.</p> <p>Enter DEST, followed by a space, and datafill refinement DEST if the destination is known.</p> <p>Enter EXTCIC, followed by a space, and enter data for refinements CICSIZE, SKIPDIGS, and SOURCE. The EXTCIC option indicates the external carrier identification code. This option is supported for TOPS calls.</p> <p>Enter IAA, followed by a space, and enter data for refinement IAA_INDEX. The IAA option generates or modifies IAA message parameters based on datafill in table IAACtrl.</p> <p>Enter LNET, followed by a space, and enter data for refinement LNET. Enter data for this option if the system requires a logical network for metering.</p>

AMHEAD (continued)**Field descriptions for conditional datafill (Sheet 4 of 16)**

Field	Subfield or refinement	Entry	Explanation and action
			<p>Enter MM, followed by a space, and datafill refinements MIN and MAX if the minimum and maximum dialed digits are known.</p> <p>Enter MZONE, followed by a space, and datafill refinement MZONE if metering is to be done on the call.</p> <p>Enter NETSRV and datafill refinement NETSRV_NAME to indicate a Japan network service.</p> <p>Enter MM, followed by a space, and datafill refinements MIN and MAX if the minimum and maximum dialed digits are known.</p> <p>Enter MZONE, followed by a space, and datafill refinement MZONE if metering is to be done on the call.</p> <p>Enter NETSRV and datafill refinement NETSRV_NAME to indicate a Japan network service.</p> <p>Enter OSS to indicate operator signaling services. This subfield does not have refinements.</p> <p>Enter PCC, followed by a space, and datafill refinement PCCDR if a pseudo country code is required.</p> <p>Enter PF, followed by a space, and datafill refinement PFDIGS if there are prefix digits in the digit stream.</p> <p>Enter PNRF to invoke the ported number recognition function. LNP applications in Germany use the PRNF. The PNRF option does not have refinements.</p>

AMHEAD (continued)

Field descriptions for conditional datafill (Sheet 5 of 16)

Field	Subfield or refinement	Entry	Explanation and action
			<p>Enter PRESEL, followed by a space, and datafill refinement PRESEL to provide the necessary information used to index into the PCIXLA table.</p> <p>Enter PRIVL, followed by a space, and datafill refinement PRIVL if the user is a privileged user (for example, operators).</p> <p>Enter QFT followed by ON or OFF to indicate if an outgoing route is capable of QSIG feature transparency.</p> <p>Note: Operating company personnel must not add the QFT ON option to a route unless the far-end node is QFT-capable.</p> <p>Enter SETCDN, followed by a space, and enter data for refinement CDNNAME. The SETCDN option assigns the called number name (CDNNAME) from table CDNCHAR to the call.</p> <p>Enter TELETAXE. This option does not have refinements.</p> <p>Enter TOC, followed by a space, and datafill refinement CHG for the type of charge if the type of charge messaging is selected.</p> <p>Enter VPN, followed by a space, and datafill refinements ONNET and BILLABLE if the call routes through a service switching point (SSP) and feature package NTXH49AA or NTXH49AB (VPN-SSP) is in the switching unit.</p> <p>Enter XLT, followed by a space, and datafill refinement XLASYS if the call is to proceed to another translation system.</p>
	ACF	0 to 29	<p>Area code fence. If the entry in subfield OSEL is ACF, datafill this refinement. Enter the number of digits between the beginning of the digits to currently index the table, and the end of the area code.</p>

AMHEAD (continued)**Field descriptions for conditional datafill (Sheet 6 of 16)**

Field	Subfield or refinement	Entry	Explanation and action
	BILLABLE	Y or N	Virtual private network billable call. If the entry in subfield OSEL is VPN, datafill this refinement. Enter Y if an AMA record is required for each VPN call. Otherwise, enter N. An AMA record is not generated if an address complete message (ACM) of address complete, no charge is returned, or if the call terminates in the SSP on a line with the free number terminating (FNT) option.
	CALLCLASS	PRESELECT OVERRIDE, CSN, or TRUNK	<p>Preselection call processing. If the entry in subfield OSEL is PRESEL, datafill this refinement. Enter the preselection call class type that is associated with the call.</p> <p>Note: Calltype CSN and TRUNK are available under the PRESEL option. These call classes are not needed for German Carrier Selection, and are not supported. The same applies to the Continue option of CONT. For the German market, only NOCONT is supported.</p>

AMHEAD (continued)

Field descriptions for conditional datafill (Sheet 7 of 16)

Field	Subfield or refinement	Entry	Explanation and action
	CALLCTRL	CALLED, CALLING, or MUTUAL	<p>Call control. If the entry in subfield OSEL is CALLCTRL, enter one of the following three values to specify the party that has control of the call:</p> <ul style="list-style-type: none"> If the entry is CALLED and the called line goes on-hook first, the call is released immediately. If the calling line goes on-hook first and does not reanswer, the connection is not released until the called line goes on-hook. There are no time-outs, and the calling party is allowed to reanswer until the called line goes on-hook. <p>Calls to lines with option ESG must have CALLCTRL(CALLED).</p> <p>Calls terminating on an ITOPS position must have CALLCTRL(CALLED).</p> <ul style="list-style-type: none"> If the entry is CALLING and the calling line goes on-hook first, the call is released immediately. If the called line goes on-hook first, the called party is allowed to reanswer within a datafilled reanswer time-out or until the calling line goes on-hook. If the time-out expires or if the calling line goes on-hook, the calling party releases the call and the called line is set to idle. If the entry is MUTUAL and either line goes on-hook, the call is released immediately.
	CDNNAME	alphanumeric string	Called number name. If the entry in subfield OSEL is SETCDN, enter data for refinement CDNNAME.

AMHEAD (continued)**Field descriptions for conditional datafill (Sheet 8 of 16)**

Field	Subfield or refinement	Entry	Explanation and action
	CHG	SEND_ CHARGE or SEND_NO_ CHARGE	Charge. If the entry in subfield OSEL is TOC, datafill this refinement. Enter SEND_CHARGE to set the answer message (BTUP ANM) type of answer (TOA) string sent out from a node to SEND_CHARGE. Enter SEND_NO_CHARGE to set the answer message (BTUP ANM) type of answer (TOA) string sent out from a node to SEND_NO_CHARGE.
	CICSIZE	1 to 4	CIC size. If the entry in subfield OSEL is EXTCIC, enter data for this refinement. This field indicates the number of digits in the CIC. This field operates on the B (called) number, so it is assumed that the system signals the CIC as part of the B number. The MAP display indicates the range is 0 to 4. The system does not allow an entry of 0.

AMHEAD (continued)**Field descriptions for conditional datafill (Sheet 9 of 16)**

Field	Subfield or refinement	Entry	Explanation and action
	CLASS	ATT, CNTL, COLL, DATT, EMRG, IAGRP, ICNTL, INTL, IOPRA, LCL, NATL, OPRA, RURAL, SPEC, or UNKW	<p>Translation class. If the entry in subfield OSEL is CLASS, datafill this refinement. Enter the translation class determined by the dialed digits. This can be used for screening or billing purposes as described under CLASS in screening and charging options.</p> <ul style="list-style-type: none"> • ATT (attendant console) • CNTL (continental) • COLL (collect) • DATT (dial attendant) • EMRG (emergency) • IAGRP (interagent group) • ICNTL (intercontinental) • INTL (international) • LCL (local) • IOPRA (international operator assisted) • NATL (national) • OPRA (operator assisted) • RURAL (rural) • SPEC (special) • UNKW (unknown)
	CLDFMT	CURRENT or POSTXLA	<p>Called format. If the entry in subfield OSEL is CAMA, enter either CURRENT or POSTXLA to produce the required ICAMA record format.</p> <p>If the entry is CURRENT, an ICAMA record is produced with the signaled DN (without translation).</p> <p>If the entry is POSTXLA, an ICAMA record is produced with public switched telephone network (PSTN) number resulting from translations.</p>

AMHEAD (continued)**Field descriptions for conditional datafill (Sheet 10 of 16)**

Field	Subfield or refinement	Entry	Explanation and action
	CLIOVRD	CNA, CNB	Calling line identity override. If the entry in subfield OSEL is CLIOVRD, enter data for refinement CLIOVRD. Enter CNA to allow the calling number for each call. Enter CNB to block the calling number for each call.
	CONDIGS	numeric (0 to 29 digits)	Consumed digits. If the entry in subfield OSEL is CONSUME, datafill this refinement. Enter a number to explicitly define the number of digits consumed during call processing.
	CONTINUE	CON or NOCON	<p>Consume digits. The default options only apply if a tuple with field XLASEL set to CONT or DMOD is chosen in the code tables.</p> <p>The default case is not to consume digits (that is, the next table is indexed using the same digits as the current table, except for ignoring prefix digits). However, under certain conditions, the next table is indexed starting with the digits following the index to the current table (in other words, translations absorb or consume the current index digits). An example of this is when an area code is found in table FACODE. Table OFCCODE is indexed with the digits following the area code (the office code), so the digits used to index table FACODE are consumed. Note that this does not mean that the digits are deleted from the digit register. They are still there, and are outpulsed unless explicitly deleted in the code or route tables. The CON option only means that they are not used to index the next table.</p> <p>Enter CON and translation consumes the current index digits, if the next table is indexed starting with the digits following the index to the current table. Consume does not mean that the digits are deleted from the digit register, they remain there and are outpulsed unless explicitly deleted in the code or route tables. Option CON only means that the digits used to index the current table are not used to index the next table.</p>

AMHEAD (continued)

Field descriptions for conditional datafill (Sheet 11 of 16)

Field	Subfield or refinement	Entry	Explanation and action
	CONTINUE (continued)	CON or NOCON	<p>Enter NOCON if digits are not to be consumed (the next table is indexed using the same digits as the current table, except the prefix digits).</p> <p>Note: To suppress the consumption of digits contained in field CONDIGS of code table AMCODE enter NOCON, which will cause any to-be-consumed digits contained in field CONDIGS to be ignored. It is not necessary to remove the digits contained in field CONDIGS of code table AMCODE to suppress the consumption of these digits.</p>
	CPMCALL	Y or N	<p>Called party metering. If the entry in subfield OSEL is CPMCALL, datafill this refinement. Enter Y (yes) if calls are billed against the called party for intraoffice calls. Enter N (no) for the default value of billing against the calling party for intraoffice calls.</p>
	DDIDX	1 to 63 or DEFAULT	<p>Destination discount index. If the entry in subfield OSEL is DDIDX, enter data for this refinement. Enter the destination discount index number.</p>
	DEST	0 to 1023	<p>Destination route list index. If the entry in subfield OSEL is DEST, datafill this refinement. Enter the number in the route list, of the same translation system, that the call is routed to.</p>
	IAA_INDEX	0 to 1024	<p>Interadmission accounting index. If the entry in subfield OSEL is IAA, enter data for this refinement. Enter the value that indexes the corresponding tuple in table IAACtrl.</p>

AMHEAD (continued)**Field descriptions for conditional datafill (Sheet 12 of 16)**

Field	Subfield or refinement	Entry	Explanation and action
	LNETH	alphanumeric (1 to 8 characters)	Logical network. If the entry in subfield OSEL is LNETH, enter data for this refinement. This refinement specifies the name of the logical network that carries the call. Table LNETWORK must already have the logical network. The international metering system uses the entry in this field to determine the tariff for the call.
	MAXIDX	C, F, and STD or 9	<p>Maximum index. Enter C if the translation tables are to be indexed by dialed digits hexadecimal B (*) and hexadecimal C (#) in addition to digits in the range 0 to 9.</p> <p>Enter F if the translation tables are to be indexed by dialed digits in the range 0 to 9, and hex digits B, C, D, E, and F.</p> <p>Enter STD or 9 if the translation tables are to be indexed by dialed digits in the range 0 to 9. The default entry is 9.</p>
	MAX	0 to 30	Maximum digits. If the entry in subfield OSEL is MM, datafill this refinement. Enter the maximum number of digits expected. This value includes the digits used to index the current tuple and must also include the prefix digits specified in the current tuple.
	MIN	0 to 30	Minimum digits. If the entry in subfield OSEL is MM, datafill this refinement. Enter the minimum number of digits expected. This value includes the digits used to index the current tuple and must also include the prefix digits specified in the current tuple.
	MZONE	0 to 63	Metering zone. If the entry in subfield OSEL is MZONE, datafill this refinement. Enter the metering zone of the call, in the logical network as defined by selector LNETH. The entry in this field is used by the international metering system to determine a tariff for the call.

AMHEAD (continued)

Field descriptions for conditional datafill (Sheet 13 of 16)

Field	Subfield or refinement	Entry	Explanation and action
	NETSRV_ NAME	IPHS, DPHS, MOBILE, DA, TELEGRAM, or NCC	<p>Network service name. If the entry in subfield OSEL is NETSRV, datafill this refinement. The entry in this field determines the parameters in an outgoing IAM message.</p> <p>Enter IPHS to indicate a call to an independent personal handyphone system subscriber.</p> <p>Enter DPHS to indicate a call to a dependent personal handyphone system subscriber.</p> <p>Enter MOBILE to indicate a call to a mobile subscriber.</p> <p>Enter DA to indicate a call to the directory assistance operator.</p> <p>Enter TELEGRAM to indicate a call to the Telegram office.</p> <p>Enter NCC to indicate a call routed to one of the following networks:</p> <ul style="list-style-type: none"> • New Common Carrier serving international toll traffic • New Common Carrier serving national toll traffic
	NOA	INTL, LOCAL, NATL, or NET	<p>Called nature of address parameter. If the entry in subfield OSEL is CDN, datafill this refinement. Enter the required called party nature of address.</p> <p>If the called party is an international number, enter INTL. If the called party is a local number, enter LOCAL. If the called party is a national number, enter NATL. If the called party subscribes to Intelligent Network Services, enter NET.</p>

AMHEAD (continued)

Field descriptions for conditional datafill (Sheet 14 of 16)

Field	Subfield or refinement	Entry	Explanation and action
	ONNET	Y or N	<p>Call on virtual private network. If the entry in subfield OSEL is VPN, datafill this refinement. Enter Y (yes) if the call stays within the defined virtual private network. Otherwise, enter N (no).</p> <p>Overlapped outpulsing is only supported on off-network calls. Calls processed without the ONNET subfield set to Y are off-network calls. Meridian Digital Centrex (MDC) calls are treated as off-network calls, and therefore overlapped outpulsing is supported for MDC calls.</p>
	PCCDR	0 to 9, B, C, D, E (1 to 3 digits)	<p>Pseudo country code digits. If the entry in subfield OSEL is PCC, datafill this refinement. Enter the three-digit pseudo country code (PCC). If a two-digit PCC is required, it must be padded by a leading zero.</p> <p>The pseudo country code is used to record a particular pseudo country code. This can be extracted for use by system logic later, for example, two-stage outpulsing.</p>
	PFDIGS	0 to 24	<p>Number of prefix digits. If the entry in subfield OSEL is PF, datafill this refinement. Enter the number of prefix digits. If prefix digits are identified in a previous table, this number is added to the existing value. Prefix digits are not used to index any further translation tables and are not outpulsed, but they remain stored in call detail records (CDR).</p> <p>Note: If refinements PF and CONSUME are both datafilled for the same tuple, only the entry for the greater of the two values is processed; the other entry is ignored.</p>
	PFXAMA	0 to 4 digits or N	<p>Called party number prefix in AMA. If NOA is set to NTL, enter 0011 in PFXAMA.</p> <p>If NOA is set to NATL, enter 0 in PFXAMA.</p> <p>If NOA is set to LOCAL or NET, enter N in PFXAMA.</p>

AMHEAD (continued)

Field descriptions for conditional datafill (Sheet 15 of 16)

Field	Subfield or refinement	Entry	Explanation and action
	PRIVL	Y or N	Privileged user. If the entry in subfield OSEL is PRIVL, datafill this refinement. Enter Y (yes), if the user is a privileged user (for example, operator). Otherwise, enter N (no).
	SKIPDIGS	0 to 24	Skip digits. If the entry in subfield OSEL is EXTCIC, enter data for this refinement. This field indicates the number of digits to skip before removing the carrier digits from the digit stream. This field operates on the B (called) number, so it is assumed that the system signals the CIC as part of the B number.
	SOURCE	PRESUB or DIALED	Carrier identification code source. If the entry in subfield OSEL is EXTCIC, enter data for this refinement. This field specifies the source of the CIC as follows: <ul style="list-style-type: none"> • PRESUB - presubscribed. Table TRKGRP defines the CIC. • DIALED - dialed. The subscriber enters the CIC when dialing a call.
	STOPRTMR	Y or N	Stop remote timer. Enter Y (yes) to disable the address complete message (ACM) timer of the remote switch. The default value is N (no).
	XLAIID	FREE, GENERIC1, GENERIC2, or GENERIC3	AMA translation identifier. If the entry in subfield OSEL is AMAXLAID, datafill this refinement. Enter the AMA translation identifier to be used against table AMAXLAID.

AMHEAD (continued)**Field descriptions for conditional datafill (Sheet 16 of 16)**

Field	Subfield or refinement	Entry	Explanation and action
	XLASYS	AC, AM, CT, DN, FA, FT, NSC, OFC, PX	<p>Translation system. If subfield OSEL is set to XLT, datafill this refinement. Enter the next translation system to use, followed by a space, then datafill refinement XLANAME.</p> <ul style="list-style-type: none"> • AC (access) • AM (ambiguous) • CT (country) • DN (directory number) • FA (foreign area) • FT (utility) • NSC (number service code) • OFC (office) • PX (prefix) <p>Note: NIL is not a valid entry. NIL is only used to satisfy internal software functionality.</p>
	XLANAME	alphanumeric (1 to 8 characters)	<p>Translation name. If the entry in subfield OSEL is XLT, datafill this refinement. Enter the translation name of the table instance within the XLASYS that the call is routed to.</p>

Datafill example

An example of datafill for subtable OFC234 is shown below.

Subtable AM234 is referenced. The dialed digits are 234-727-1364.

Since more digits were dialed than for a local call, the route is changed. Default options apply with selector RTE, so the default options are taken from table OFCHEAD tuple with subfield XLANAME value OFC234. The destination reference given in the AMCODE tuple applies to the fourth route list in subtable OFC234 of table OFCRTE. Note that class NATL and DEST 4 in table AMCODE override class LCL and DEST 2 in table OFCCODE. It is necessary to refer to table AMCODE after a destination was found because it can change depending on the number of digits dialed.

If no ambiguous code tuple is selected, the entry in field DFLT from tuple AM234 in table AMHEAD is used.

AMHEAD (continued)

Although the AMCODE result says that if there are eight or more digits, the call is routed to destination 4, option MM in table OFCHEAD says that a maximum of ten digits are allowed. If more than ten digits are dialed, the call is not routed. Option MM takes precedence over the ambiguous code table results. Note that care must be taken that they do not conflict, but rather that MM provides a boundary for the ambiguous code results.

MAP display example for table OFCHEAD

XLANAME	DFLT
CON MAXIDX	DFOP
<hr/>	
OFC234	SDFLT
DFOP (MM 6 10) \$	
NOCON 9	

MAP display example for table AMHEAD

XLANAME	DFLT
<hr/>	
OFC234 234 235	
CONT (XLT AM AM234) (DEST 2) (CLASS LCL) \$	

MAP display example for table OFCRTE

XLANAME	RTEREF	RTELIST
<hr/>		
OFC234	2	(N LOCALCLLI DEL 3 PFXDIGS 09) \$
OFC234	4	(S NEXTOWN) \$

AMHEAD (continued)**MAP display example for table AMHEAD**

XLANAME	DFLT
AM234	SDFLT

MAP display example for table AMHEAD

XLANAME	DFLT
AM234 8 GE	
RTE (DEST 4) (CLASS NATL) \$	

Table history**APC010**

Added field TLC_CHARGE to option TLC in the FEATINFO selector.

APC009

Added option NETSRV to selectors CONT and RTE.

Added option JES to selector FEATINFO.

APC008.1

The following updates were introduced in APC008.1 to table AMHEAD:

- Field CHKCCR was added to all subscriber types (SUBSCTYP) that are part of the SUBSCRN option of selector FEATINFO VALIDATE.
- Field EARLYCPG was added to selector FEATINFO.
- Option IAA was added to selectors ROUTE and CONT.

GL04

Provided the ability to datafill FLEXCHG in the RTE and CONT selectors.

Provided the ability to datafill CHGIND in the RTE and CONT selectors.

Provided the ability to datafill ISUPPREF in the RTE and CONT selectors.

AMHEAD (continued)

GL003

The following updates were introduced in GL03 to table AMHEAD:

- Provided the ability to datafill ACF in RTE and CONT selectors.
- Provided the ability to datafill CAMA in RTE, CONT, and DNRTE selectors.
- Added URBAN to selector CLASS.
- Applied effectivity to GL03 specific sections.

NA005

The following updates were introduced to table AMHEAD in NA005:

- increased the number for universal translations support to 30 digits, affecting the following options, subfields or selectors:
 - ACF
 - AFTER
 - CONSUME
 - DEL
 - DMOD
 - DNRTE
 - INSRT
 - MAX
 - MIN
 - PF
 - REPL
- added option SF and its refinement SFDIGS to selector DNRTE.
- added note about potential conflict with refinements CONSUME and PFDIGS

APC006

Subscriber type PERSONAL added to option SUBSCRN of FEATINFO VALIDATE.

APC004

Subfield CDN of selectors CONT and RTE was modified to incorporate subfields NOA, STOPRTMR, and PFXAMA.

BCS35

The following option and refinement were added:

- option CGNDM with refinements PRDFXCLI and INSRTCLI
- refinement CPMCALL to XLASELs CONT and RTE

AMRCAT

Table name

AMR Category Digits Table

Functional description

Table AMRCAT is required in toll or combined local and toll switching units that have incoming traffic from North AMR5 trunk groups.

The following is the switching unit dependent data required for each of the entries in the AMR5 category digits table:

- the AMR category name to which the entry belongs
- the category digits
- the originating type assigned to the category digits, such as coin, hotel, or operator number identification
- if signaling format is AMR5A, the type of call: direct dial (DD), operator assisted (OA), or no prefix (NP)
- the serving numbering plan area (SNPA)
- the route index into the AMR route table for category digits that the switching unit does not translate

For related information, refer to table TRKGRP.

Datafill sequence and implications

Table HNPACONT must be datafilled before table AMRCAT.

Table size

1 to 15 tuples

AMRCAT (continued)**Datafill**

The following table lists datafill for table AMRCAT.

Field descriptions (Sheet 1 of 2)

Field	Subfield or refinement	Entry	Explanation and action
AMRKEY		see subfields	<i>AMR key</i> This field consists of subfields AMCATNM and DIGITS.
	AMCATNM	ONE, STD, STD2, TOPS, ZERO, or NIL	<i>AMR category name</i> Enter the name given to a specific set of category digits.
	DIGITS	numeric (up to 18 digits)	<i>Digits</i> Enter the required category code.
ORIGTYPE		ANI ANIFAIL ANIONI AUTOTC COIN HOTEL DENTOLL ONI SPECIAL STATION or IMTS	<i>Origination type</i> Enter one of the following origination types: <ul style="list-style-type: none"> • ANI (automatic number identification) • ANIFAIL (ANI fail) • ANIONI (automatic and operator number identification) • AUTOTC (automatic time and charge) • COIN (coin) • DENTOLL (denied toll) • HOTEL (hotel) • IMTS (marine or mobile telephone) • ONI (operator number identification) • SPECIAL (special non-paid) • STATION (station)
CALLTYPE		DD, NP, OA, or NL	<i>Call type</i> If the signaling format is AMR5A, enter the type of call: DD (direct dial), OA (operator assisted, or NP (no prefix). If signaling format is AMR5B, no type of call required. Enter NL.

AMRCAT (end)

Field descriptions (Sheet 2 of 2)

Field	Subfield or refinement	Entry	Explanation and action
SNPA		numeric(3 digits)	<i>Serving numbering plan area</i> Enter the serving numbering plan area (SNPA) associated with the category code.
ROUTEIND		1, 2, 3, or NIL	<i>Route index</i> Enter the route index into table AMRROUTE for category digits that the switching unit doesn't translate. If no route index is applicable, enter NIL.

Datafill example

An example of datafill for table AMRCAT with AMR5A signaling is shown below.

The example consists of one set of category digits that is assigned the name standard (STD).

Category codes beginning with 5 are associated with the home NPA 613. Category codes beginning with 6 are associated with the first adjacent NPA 819.

AUTOTC (automatic time and charge) calls are routed to route index number 1. COIN and HOTEL calls are routed to route index number 2 in table AMRROUTE.

MAP display example for table AMRCAT

AMRKEY	ORIGTYPE	CALLTYPE	SNPA	ROUTEIND
STD 50	ANI	DD	613	NIL
STD 51	AUTOTC	DD	613	1
STD 52	HOTEL	DD	613	2
STD 53	COIN	DD	613	2
STD 57	TOLLDEN	DD	613	NIL
STD 60	ANI	DD	819	NIL
STD 61	AUTOTC	DD	819	1
STD 62	HOTEL	DD	819	2
STD 63	COIN	DD	819	2
STD 67	TOLLDEV	DD	819	NIL

AMRROUTE

Table name

AMR Route Table

Functional description

Table AMRROUTE is required in toll switching units with incoming from North American AMR5 trunk groups if one or more of the category digits specified in table AMRCAT route to one of the indices in table AMRROUTE.

The following is the switching unit dependant data required for each of the entries in table AMRROUTE:

- the index into the table
- the index into table OFRT to which translation is to route

For more information on trunk group AMR5, refer to table TRKGRP for trunk group type A5.

Datafill sequence and implications

There is no requirement to datafill other tables prior to table AMRROUTE.

Table size

Memory is automatically allocated for three tuples.

Datafill

The following table lists datafill for table AMRROUTE.

Field descriptions (Sheet 1 of 2)

Field	Subfield or refinement	Entry	Explanation and action
AMRRTIDX		1 to 3	<i>American route index</i> Enter the route index number.
ROUTE		see subfield	<i>Route</i> This field consists of subfields TABID and KEY.

AMRRROUTE (end)

Field descriptions (Sheet 2 of 2)

Field	Subfield or refinement	Entry	Explanation and action
	TABID	OFRT	<p><i>Table name</i></p> <p>Enter the office route table (OFRT) to which translation has to route.</p> <p>Any entry outside the range indicated for this field is invalid.</p>
	KEY	0 to 1023	<p><i>Index</i></p> <p>Enter the index in the office route table to which translation has to route.</p>

Datavfill example

The following example shows sample datafill for table AMRRROUTE.

AMR route index 1 is the route taken by translations when the category digits 51 or 61 are translated in table AMRCAT.

AMR route index 2 is the route taken by translations when the category digits 52, 53, 62 or 63 are translated in table AMRCAT.

MAP display example for table AMRRROUTE

AMRRRTIDX	ROUTE
1	OFRT 6
2	OFRT 7

ANIATTRS

Table name

Automatic Number Identification Attributes Table

Functional description

Table ANIATTRS is a screening table that contains the directory numbers (DN) of subscribers whose calling line information will not be displayed to the terminating subscriber.

All automatic number identification digits datafilled in this table will have the initial address message (IAM) calling party number parameter flagged as ``presentation restricted.".

Note: A Traffic Operator Position System (TOPS) toll office can provide operator services for operator assisted (OA) calls routed from non-TOPS toll offices. These calls arrive at the TOPS toll office over TOPS type trunk groups. To provide screening at the TOPS toll office for these types of OA calls, the table ANIATTRS datafill in the originating non-TOPS toll office must be duplicated in the TOPS toll office. The duplicated datafill is only required in the TOPS toll office when office parameter SUPPRESS_ANI_TO_CLID_DISPLAY is set to N (no). If this parameter is set to Y (yes), all calls in the TOPS toll office will be flagged as ``presentation restricted," regardless of the datafill in table ANIATTRS.

Datafill sequence and implications

There is no requirement to datafill other tables prior to table ANIATTRS.

Table size

The minimum size of this table is 0 tuples.

There is no restriction on the maximum size of this table.

ANIATTRS (end)

Datafill

The following table lists datafill for table ANIATTRS.

Field descriptions

Field	Subfield or refinement	Entry	Explanation and action
ANIKEY		see subfields	<i>Automatic number identification key</i> This field consists of subfields NPA, NXX, MS_XX, and LS_XX, which comprises the ten-digit ANI sequences of those subscribers that choose to have their DNs suppressed from display.
	NPA	200 to 999	<i>Numbering plan area</i> Enter the numbering plan area.
	NXX	200 to 999	<i>NXX</i> Enter the office code
	MS_XX	00 to 99	<i>MS_XX</i> Enter a two-digit number.
	LS_XX	00 to 99	<i>LS_XX</i> Enter a two-digit number.

Datafill example

The following example shows sample datafill for table ANIATTRS.

MAP display example for table ANIATTRS

ANIKEY
919 843 26 00
919 843 26 50
618 848 17 54

Table history
BCS36

Fields NPA, NXX, MS_XX, and LS_XX were added.

ANICNCTL

Table name

ANI Control

Functional description

Table ANICNCTL contains the CLLI codes for the trunk groups on which the ANI to CN conversion is to be performed. The DMS performs the conversion for a trunk group only if its CLLI code is listed here.

When a CLLI code is correctly datafilled in table ANICNCTL, ANI to CN conversion is activated for that trunk group.

The CLLI code specified in table ANICNCTL must be present in table TRKGRP. Once the presence of the CLLI code in table TRKGRP is verified, the ANI is converted to a charge number, and billing proceeds as normal.

Only SC or TOPS trunk group CLLI codes can be datafilled in table ANICNCTL.

Datafill sequence and implications

Trunk group CLLI codes must be datafilled in table TRKGRP before they can be datafilled in table ANICNCTL.

Trunk group CLLI codes must be removed from table ANICNCTL before they can be removed from table TRKGRP.

Table size

Each entry in table ANICNCTL requires 0.125 bytes of data store. The maximum number of entries in table ANICNCTL is 8192 (actual table size is defined in the constant CLLI_TABLE_MAX_ITEM_COUNT).

Maximum data store requirement = 8192 x 0.125 = 1 kbyte.

Datafill

The following table lists datafill for table ANICNCTL.

Field descriptions

Field	Subfield or refinement	Entry	Explanation and action
TRKGRP		1 through 16 alphanumeric characters	Trunk Group. Specifies the CLLI code of the SC or TOPS trunk group on which ANI to CN conversion is to be performed.

ANICNCTL (end)

Datafill example

The following example shows sample datafill for table ANICNCTL.

MAP display example for table ANICNCTL

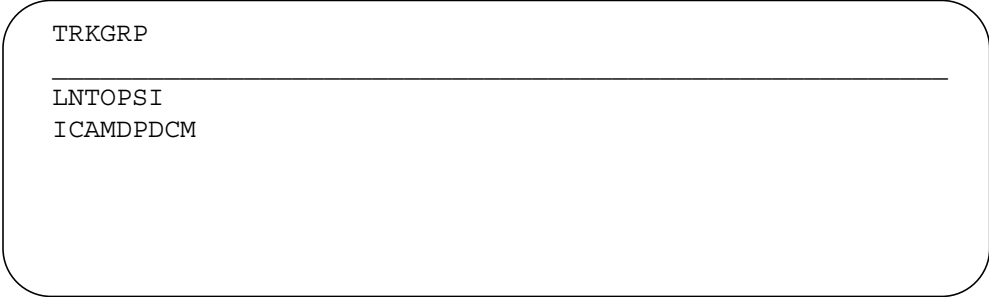

```
TRKGRP
-----
LNTOPSI
ICAMPDCM
```

Table history

NA002

Table ANICNCTL was introduced for the ANI to CN Conversion feature.

ANIDATA**Table name**

Automatic Number Identification Data Table

Functional description

Table ANIDATA is datafilled at three automatic number identification (ANI) levels—NPA (numbering plan area), NXX (three-digit exchange number), and SUB (subscriber)—to provide the ANI screening capability at all three levels on all incoming NSSFGD calls. A lookup table function is also provided for the Network System Service (NSS) Replacement of Dialed Digits (RDD) feature.

Datafill sequence and implications

There is no requirement to datafill other tables prior to table ANIDATA.

Table size

0 to 128 000 000 tuples

Memory is allocated dynamically for this table. The maximum number of tuples depends on the switch configuration.

Datafill

The following table lists datafill for table ANIDATA.

Field descriptions (Sheet 1 of 2)

Field	Subfield or refinement	Entry	Explanation and action
ANIDIGS		alphanumeric (up to 10 characters)	<p><i>Automatic number identification digits</i> Enter the ANI register as follows:</p> <ul style="list-style-type: none"> • If three digits are entered in this field, enter NPA in field ANITYPE. • If six digits are entered in this field, enter NXX in field ANITYPE. • If 10 digits are entered in this field, enter SUB in field ANITYPE.
REFAREA		see subfields	<p><i>Automatic number identification data reference area</i> This field consists of subfields ANITYPE and STATUS</p>

ANIDATA (continued)**Field descriptions (Sheet 2 of 2)**

Field	Subfield or refinement	Entry	Explanation and action
ANITYPE		NPA, NXX, or SUB.	<i>Automatic number identification type</i> Enter the ANI type in accordance with the instructions set out in field ANIDIGS above.
STATUS		ALLOW, CASUAL, or NOTALW	<i>Status</i> Enter the calling party's status as follows: <ul style="list-style-type: none"> • If the entry in field ANIDIGS is three or six digits, and the entry in field ANITYPE is NPA or NXX, enter CASUAL or NOTALW. • If the entry in field ANIDIGS is ten digits, and the entry in field ANITYPE is SUB, enter ALLOW, CASUAL, or NOTALW.

STATUS = ALLOW

If the entry in subfield STATUS is ALLOW, datafill fields NACUSGRP, NANCOS, ACCTREQ, SUPPRESS, and IDDALLOW.

Field descriptions for conditional datafill (Sheet 1 of 2)

Field	Subfield or refinement	Entry	Explanation and action
	NACUSGRP	alphanumeric (up to 16 characters)	<i>North American numbering plan area customer group</i> Enter the customer group defined in table CUSTHEAD.
	NANCOS	0 to 511	<i>North American numbering plan area network class of service</i> Enter the network class of service (NCOS) of the customer group.
	ACCTREQ	Y or N	<i>Account code required</i> Enter Y (yes) if an account code is required for all incoming NSSFGD calls using pure dialing that originate from the offnet address specified by this ANI. Enter N (no) if an account code is not required.

ANIDATA (continued)**Field descriptions for conditional datafill (Sheet 2 of 2)**

Field	Subfield or refinement	Entry	Explanation and action
	SUPPRESS	Y or N	<i>Suppress</i> Enter Y if offnet originated stations entering the network by way of a NSSFGD trunk using pure dialing are to have their ANI information suppressed, preventing the display of their directory number (DN). Enter N if ANI suppression is not required.
	IDDALLOW	Y or N	<i>International direct distance dial allowed</i> Enter Y if a call referencing ANI type SUB with STATUS set to ALLOW is allowed to make international calls outside world zone 1. If this field is set to N, international calls are not allowed and the call is sent to treatment.

IDDALLOW = Y

If the entry in field IDDALLOW is Y, datafill fields INTLCGRP and INTLNCOS.

Field descriptions for conditional datafill

Field	Subfield or refinement	Entry	Explanation and action
	INTLCGRP	alphanumeric (up to 16 characters)	<i>International customer group</i> Enter the customer group allowed to make international calls.
	INTLNCOS	0 to 511	<i>International network class of service</i> Enter the NCOS of the customer group allowed to make international calls.

Datafill example

The following example shows sample datafill for table ANIDATA.

ANIDATA (end)

MAP display example for table ANIDATA

ANIDIGS	REFAREA	
742223	NXX	CASUAL
214	NPA	NOTALW

ANNAUDID

Table name

Announcement Audio Identifier Mapping

Functional description

Table ANNAUDID provides the mapping from the announcement phrase identification (PHRASEKY) to the UAS announcement segment identification (AUDID). The key field (PHRASEKY) contains the phrase ID field that refers to an external phrase number. The audio ID field (AUDID) contains the announcement ID that matches the provisioned audio segment on the UAS.

Table ANNAUDID is used for both broadcast and custom announcements on the UAS.

Datafill sequence and meaning

Table ANNAUDID must be datafilled after SERVSINV and before ANNPHLST.

Table size

The maximum number of entries for table ANNAUDID is 8 191.

Datafill

The table below describes the datafill for table ANNAUDID.

Field descriptions

Field	Subfield	Entry	Explanation and action
PHRASEKY			<i>Phrase key.</i> This field contains the phrase that refers to an external phrase number. This field has subfield PHRASENAME.

ANNAUDID (end)**Field descriptions**

Field	Subfield	Entry	Explanation and action
	PHRASENAME	alphanumeric (up to a maximum of 16 characters)	<i>Phrase name.</i> For custom phrases on UAS, enter predefined or custom phrase name specific to the custom announcement. For broadcast phrases on UAS, define a phrase to represent the associated broadcast announcement.
AUDID		0 to 32 767	<i>Universal Audio Server (UAS) audio identifier.</i> The field AUDID maps to a provisioned audio identifier that is in the UAS.

Datafill example

The figure below shows sample datafill for table ANNAUDID.

MAP display example for table ANNAUDID

PHRASEKY	AUDID
AUD_1000	1000
AUD_1001	1001
CFRAEDNPIN1	1210
CFRAEFAC	1211
CFRAEFWDN	1212
CFRAEERR1	1215

Table history**SN06 (DMS)**

Phrase key changed to alphanumeric string. Feature A19013546.

SN02

Table introduced

ANNMEMS

ATTENTION

This table applies to new or modified content for SN09 (DMS) that is valid through the current release.

Mapping members to announcements

Table Announcement Members (ANNMEMS) provides members for each announcement group that appears in table ANNS and maps the member to a peripheral.

For DRAM or AUDICHRON types, each member designates a physical voice channel where the announcements will be played.

For UAS type, each member provides the mapping between the announcement to an Audio Node.

The number of call forwarding announcement (CFRA) members must be equal to the office parameter MAX_PROGRAMMERS in table OFCENG. The number must be equal to make sure that every CFRA call can allocate a channel to the digital recorded announcement machine (DRAM). If the allocation of the announcement channel cannot occur, the CFRA call fails.

Datafill sequence and meaning

For DRAM operation, entry of the following tables must occur before table ANNMEMS:

- ANNS
- DRAMS
- CLLI
- TMINV

For the Audio Node, entry of the following tables must occur before table ANNMEMS:

- SERVSINV
- SERVRINV
- ANNS

Entry of one or more of the following tables must occur after table ANNMEMS:

- AUDIO
- CLLIMITCE
- CUSTANNS
- CUSTHEAD
- ANNPHLST
- NSCANNS
- OFRT
- OFR2
- OFR3
- OFR4
- OSSANNS
- RESOFC
- TRKGRP

Table size

The system continuously allocates memory for table ANNMEMS.

Table ANNMEMS can have a maximum of 255 tuples for each tuple in table ANNS. The maximum size of table ANNMEMS is normally 65 025. The maximum size of table ANNMEMS can be 521 985. This maximum size occurs if feature package XN26AA (announcement enhancements) or X983AB (Service Switching Point Private Virtual Networking) is in the load.

Datafill

The table below describes datafill entries for table ANNMEMS.

Table ANNMEMS field descriptions

Field	Subfield or refinement	Entry	Explanation and action
ANNMEM		see subfields	<i>Announcement member key.</i> This field contains subfields ANN and MEMBER.
	ANN	alphanumeric	<i>Announcement.</i> Enter the CLLI that represents the announcement group in table ANNS.

Table ANNMEMS field descriptions (Continued)

Field	Subfield or refinement	Entry	Explanation and action
	MEMBER	0 to 255	<i>Member.</i> If the trunk circuit is the first in the trunk list for the announcement member, enter the number assigned to the member.
HDWTYPE		AUDICHRON, DRAM, or UAS	<i>Hardware type.</i> Enter AUDICHRON if the first entry for the member and hardware type is analog. Enter DRAM if the recorded announcement member is digital. Enter UAS to support the Audio Server for the Call Server 2000 (CS 2000). When the HDWTYPE is UAS, enter field CARD and subfield PMTYPE with the entry AUD.
CARD		2X72AA 2X72AB 2X72AC 2X88AA, DRA, AUD	<i>Card code.</i> Enter the card code if the trunk member is analog. Enter DRA if the trunk member is digital. A trunk circuit contains a trunk circuit on a trunk card if a switching unit has an analog recorded announcement machine. The trunk card has product engineering code NT2X72AA, AB, or AC, or NT2X88AA on a TM8 trunk module type. Enter AUD for the CARD to support the Audio Server for the CS2000.
MEMINFO		see subfields	<i>Memory information.</i>
MEMINFO for HDWTYPE = DRAM or AUDICHRON			
When HDWTYPE = DRAM or AUDICHRON, MEMINFO has the single subfield TRCKLIST. TRCKLIST itself has subfields as detailed below.			
	TRCKLIST	see subfields	<i>Track list.</i> This field contains subfields TRACK, PMTYPE, TMNO, and TMCKT.

Table ANNMEMS field descriptions (Continued)

Field	Subfield or refinement	Entry	Explanation and action
	TRACK	0 to 31	<p><i>Track number.</i> Enter the track number assigned to the trunk circuit.</p> <p>If the announcement is multilingual, each language must be assigned to a different track (trunk circuit).</p> <p>The sequence list for the tracks in the announcement member trunk list determines the order that the listener hears the tracks. For example, if a member has three tracks in the following sequence 1, 5, and 3, the listener hears track 1 first. The listener hears track 5 next. The listener hears track 3 last.</p> <p>If announcements are bilingual, the track assigned to the priority language is the first track assigned in the member trunk list.</p>
	PMTYPE	ATM, DTM, MTM, MTMA, PTM, RMM, RSM, STM, TAN, TMA, TM2, TM4, TM8, T8A	<p><i>Peripheral module type.</i> Enter the type of peripheral module that has the trunk circuit assigned.</p> <p>If the announcement member is digital, enter maintenance trunk module (MTM) or service trunk module (STM).</p> <p>If the announcement member is analog, enter TM8.</p> <p>If the announcement member connects to an EDRAM (1X80), enter DTM.</p>

Table ANNMEMS field descriptions (Continued)

Field	Subfield or refinement	Entry	Explanation and action
			<p>In the occurrence of Mechanized Calling Card service (MCCS), the announcement channels are not for any specified announcement. In the occurrence of standard recorded announcements, announcement channels are for specified announcements. Instead, MCCS is present as a group in table ANNS. The group includes members in table ANNMEMS. The members associate with a maximum of 29 MTM dedicated channels on a specified digital recorded announcement machine (DRAM). Channel 0 is reserved for diagnostic purposes. Normally, a whole DRAM is dedicated as an MCCS machine. Any of the MCCS announcements can play back through any one channel. This play back can occur because the Traffic Operator Position System (TOPS) must have immediate connection to the MCCS announcements. A caller receives an audible ring from the MCCS announcements while the caller waits to hear an announcement.</p>

Table ANNMEMS field descriptions (Continued)

Field	Subfield or refinement	Entry	Explanation and action										
	TMNO	0 to 2047	<p><i>Trunk module number.</i> Enter the trunk module number assigned to the trunk module that has the trunk circuit assigned.</p> <p>If trunk module type is MTM, the range is 0 to 255.</p> <p>If the trunk type is TM8, STM or DTM, the range is 0 to 2047.</p> <p>If the switching unit has a DRAM, a trunk circuit contains an assignment to a trunk circuit (channel). The circuit can be on the maintenance trunk module (MTM) or on the Service Trunk Module (STM). The DRAM is on the STM. A trunk circuit cannot be assigned to trunk module circuit number 0 (zero) because this circuit is for the DRAM controller.</p>										
	TMCKT	0 to 29	<p><i>Trunk module circuit number.</i> Enter the trunk module circuit number that has the trunk circuit assigned.</p> <p>For MTMs, the DRAM can have configuration to function as an 8, 16, 24 or 30 trunk circuit interface. The configuration depends on the dip switch settings on the controller card. Four dip switches are present on the controller card. The dip switches enable the number of circuits that appear below:</p> <table border="1"> <thead> <tr> <th>Switch setting</th> <th>Trunk circuits enabled</th> </tr> </thead> <tbody> <tr> <td>None</td> <td>1 to 7</td> </tr> <tr> <td>3</td> <td>8 to 15</td> </tr> <tr> <td>2</td> <td>16 to 23</td> </tr> <tr> <td>4</td> <td>24 to 29</td> </tr> </tbody> </table>	Switch setting	Trunk circuits enabled	None	1 to 7	3	8 to 15	2	16 to 23	4	24 to 29
Switch setting	Trunk circuits enabled												
None	1 to 7												
3	8 to 15												
2	16 to 23												
4	24 to 29												

Table ANNMEMS field descriptions (Continued)

Field	Subfield or refinement	Entry	Explanation and action						
			<p><i>Note:</i> Circuits 1 to 7 are permanently enabled. These circuits do not have switch setting.</p> <p>For STMs, dip switches can enable only 15 circuits. The DRAM controller switch setting and associated circuit number assignments for STMs appear below:</p> <table> <tr> <td>Switch setting</td> <td>Trunk circuits enabled</td> </tr> <tr> <td>None</td> <td>1 to 7</td> </tr> <tr> <td>3</td> <td>8 to 15</td> </tr> </table> <p>One trunk circuit is necessary for each announcement track assigned to the announcement member.</p> <p>All trunk circuits assigned to an announcement member must be on the same trunk module.</p> <p>For DTM, use of all channels can occur. Switches that must be set are not present.</p>	Switch setting	Trunk circuits enabled	None	1 to 7	3	8 to 15
Switch setting	Trunk circuits enabled								
None	1 to 7								
3	8 to 15								
			<p>MEMINFO for HDWTYPE = UAS</p> <p>When HDWTYPE = UAS, MEMINFO has subfields PHLSTIDX, PMTYPE, and AUDNO.</p>						
	PHLSTIDX	0 to 255	<p>Phrase list index. Enter the phrase list that corresponds to phrase index in table ANNPHLST.</p> <p>Note: For custom announcement members with hardware type UAS, the PHLSTIDX field is ignored. This field is present for all members datafilled with HDWTYPE UAS, but it is consulted only if the announcement CLLI is datafilled as STND in table ANNS.</p>						

Table ANNMEMS field descriptions (Continued)

Field	Subfield or refinement	Entry	Explanation and action
	PMTYPE	AUD	<i>Peripheral module type.</i> Enter the type of peripheral module that has the trunk circuit assigned. Enter AUD for Audio Server (UAS). Enter the subfield AUDNO.
	AUDNO	0 to 255	<i>Audio number.</i> Enter AUDNO for the PMTYPE of AUD.

Datafill example

For broadcast announcements on a Audio Node, only one member can be datafilled per node. Custom announcements are datafilled to be per-connection but for those on an Audio Node, it is recommended that all the members on the same node be datafilled continuously after one another. This provides the most efficient method of selection for custom announcement members (see example below).

The figure below shows sample datafill for table ANNMEMS. The first two lines are for a broadcast announcement on an Audio Node. Only one member per node allowed.

The second two lines are for a custom announcement on an Audio Node. Members 0 and 1 reside on node 0 and are datafilled consecutively. Member 2 is on node 1 and should be datafilled next if there are to be no more connections to be datafilled on node 0. This is the recommended datafill for most effective selection of a custom announcement member.

The last line is for a DRAM announcement.

MAP display example for table ANNMEMS

ANNMEM	HDWTYPE	CARD	MEMINFO
BLDNANN	0	UAS	AUD 3 AUD 0
BLDNANN	1	UAS	AUD 4 AUD 1
CFRAANN	0	UAS	AUD 0 AUD 0
CFRAANN	1	UAS	AUD 0 AUD 0
CFRAANN	2	UAS	AUD 0 AUD 1
PSPD	1	DRAM	(1 STM 0 5) \$

Supplementary information

Packet announcement members (HDWTYPE = UAS) are not supported for custom announcements of type MDS or TOPSVR. If a UAS member is datafilled for an announcement that is datafilled in table ANNS with ANNTYPE = MDS or TOPSVR, one of the following warning messages is displayed:

- *Packet members are not supported for ANNTYPE MDS*
- *Packet members are not supported for ANNTYPE TOPSVR*

Table history**SN09 (DMS)**

Packet members cannot be datafilled for custom announcements of type TOPSVR or MDS owing to feature A00009013.

SN06 (DMS)

Changes for HDWTYPE = UAS due to feature A19013546:

- phrase list index (PHSLSTIDX) subfield added to MEMINFO fields.
- subfields VCIRCUIT and AUDID removed from MEMINFO field.

SN01

HDWTYPE = UAS introduced.

TL02

Table introduced.

ANNPHLST

ATTENTION

This table applies to new or modified content for SN09 (DMS) that is valid through the current release.

Table name

Announcement Phrase List

Functional description

Table ANNPHLST provides the phrase list for custom or broadcast announcements member in table ANNMEMS. Each ANNPHLST table entry provides the names of the phrases assigned to each track of an announcement member.

As of SN06, this new table takes the place of table DRAMTRK and DRMUSERS.

Use the digital recorded announcement machine (DRAM) recording utility (DRAMREC) to define phrases on DRAM facilities. These phrases are entered in table DRAMPHRS.

For announcements on an Audio Node, define phrases in table ANNAUDID.

Datafill sequence and meaning

Table ANNPHLST must be datafilled after ANNS and ANNMEMS.

For DRAM announcements datafill DRAMPHRS before ANNPHLST.

For announcements defined on an Audio Node datafill ANNAUDID before ANNPHLST.

Table size

Store is dynamically allocated. Minimum number of tuples is zero.

Datavill

The table that follows lists datavill for table ANNPHLST.

Field descriptions

Field	Subfield	Entry	Explanation and action
ANNPHKEY		see subfields	Announcement Phrase Key. This field has subfields CLLI and PHLSTIDX.
	CLLI	alphanumeric	Common Language Location Identifier. Enter an announcement CLLI found in table ANNS.
	PHLSTIDX	0 to 255	<p>Phrase List Index. Enter an index number depending on the type of announcement.</p> <p>For DRAM broadcast type, this number corresponds to a track index from the tracklist of the member tuple in table ANNMEMS.</p> <p>For broadcast announcement members with hardware type of UAS, this corresponds to the phrase list index field in table ANNMEMS.</p> <p>For all custom announcements, this value corresponds to a specific custom announcement index for that particular feature. See section on custom announcements.</p>
PHLIST		alphanumeric	Phrase List. Enter the phrase(s) available in table DRAMPHRS or ANNAUDID depending on whether the announcement is DRAM or UAS respectively. Can hold up to 32 phrases. For custom announcements, use the defined phrase names from the section on custom announcements.

Custom Announcements

The following features use custom announcements:

- Mechanized Calling Card Service (MCCS)
- Automatic Coin Toll Service (ACTS)
- Automatic Calling Card Service (ACCS)
- Call Forwarding Remote Access (CFRA)
- Custom Local Calling Area Signaling Services (CLASS)
- Notification of Time and Charge (NTC)
- Station Programmable PIN (SPP)
- Subscriber Activated Call Blocking (SACB)
- Capability Set 1 Revised (CS-1R) announcements
CS-1R Pre-Paid Services

Mechanized Calling Card Service

MCCS is a TOPS custom announcement type. Although the DMS250 also supports an MCCS application, that application uses standard announcements. This section applies to TOPS MCCS.

MCCS announcements can be provided by DRAMs or by packet-based media servers in a hybrid solution with IP and ENET fabrics. The Media Server 2010 (MS 2010) and the Universal Audio Server (UAS) are examples of media servers.

For DRAMs, MCCS announcements can take the form of prerecorded phrases on two NT1X76CA double density erasable programmable read-only memory (EPROM) cards. Alternatively, an operating company can record its own DRAM announcements for MCCS. Use the DRAMREC CI to define phrases on a DRAM. All MCCS announcements are single-track.

For packetized MCCS announcements, the operating company provides the recordings and provisions them on the media servers using the Announcement Provisioning Server (APS). After that, tables ANNAUDID, CLLI, ANNS, ANNMEMS, and ANNPHLST must also be datafilled in the CM.

MCCS provides no secondary language support in the CM. An operating company can provide bilingual MCCS announcements by recording the announcements in both languages. For DRAMs, since MCCS announcements are single-track, both languages must be recorded on the same track. For packetbased MCCS announcements, a sequence can be created using the APS.

In addition to basic calling card validation, the MCCS custom announcement type can be used for sequence call prompts and for the TOPS Authorization Code and Account Code Billing features.

MCCS pre-defines custom announcement numbers 1 through 9 and 15 through 23. It reserves 10 through 14 for future development. Through datafill in tables EAMCCSAN and/or MCCSNBEC, the operating company can specify that announcement numbers 24 and higher are to be used to brand the initial “thankyou” acknowledgment for correct card entry.

MCCS does not use any variable, or placeholder, phrase names. Nortel suggests, but does not require, that the operating company use phrase names shown in the table for MCCS announcements. The table shows the pre-defined MCCS announcement numbers and suggested content for each. The table shows the announcement numbers in an order that is logical in terms of call flow, rather than listing them in order by announcement number. The table uses the following abbreviations:

- Calling Card Validation (CCV)
- Sequence calling (SEQ)
- Account Billing Code (ACB)
- Authorization Code (AUTH)

Pre-defined MCCS announcements with suggested content

Pre-defined Announcement Number	When this Announcement is used	Suggested Phrase List	Suggested Content
17	Initial prompt for CCV and ACB if originating station treatment (OST) from table MCCSOST is TONE. Also used as the initial and retry prompt for AUTH.	MCCSENG 17	Alert tone (“bong”) for calling card dialing. This is a complex tone consisting of 60 ms DTMF #-tone (941/1477 Hz @ -10 dBm), followed immediately by 940 ms of exponentially decayed dial tone (440/350 Hz with time constant of 200 ms initially at -10 dBm)
18	Initial prompt for CCV and ACB if originating station treatment (OST) from table MCCSOST is TONEANN.	MCCSENG 17	
1	Re-prompt for CCV and ACB when initial prompt was announcement 18 (OST = TONEANN) and timeout occurred.	MCCSENG 1	Please dial your card number or zero for an operator now.
2	Re-prompt for CCV and ACB if caller entered an invalid card number (CCV) or invalid account code (ACB).	MCCSENG 2	Please dial your card number again now. The card number you have dialed is not valid.
19	Re-prompt when timeout occurs after caller has heard announcement 2.	MCCSENG 17	

Pre-defined MCCS announcements with suggested content

Pre-defined Announcement Number	When this Announcement is used	Suggested Phrase List	Suggested Content
3	Re-prompt when timeout occurs after caller has heard announcement 19.	MCCSENG 3	Please dial your card number.
9	Re-prompt when timeout occurs after caller has heard announcement 3.	MCCSENG 9	Please hang up and dial zero plus the number you are calling.
4	Sign-off message for CCV when caller has entered too many invalid card numbers.	MCCSENG 4	Please hang up and dial zero plus the number you are calling. (pause) The card number you have dialed is not valid.
16	Announcement played when card number (CCV) or account code (ACB) has been successfully validated.	MCCSENG 16	Thank you.
The following MCCS announcements are used for sequence calls.			
5	Prompt when # is entered, initiating a sequence call.	MCCSENG 5	You may dial another call now.
23	Re-prompt when timeout occurs after announcement 5.	MCCSENG 5	
20	Sign-off message when timeout occurs after announcement 23.	MCCSENG 9	

Pre-defined MCCS announcements with suggested content

Pre-defined Announcement Number	When this Announcement is used	Suggested Phrase List	Suggested Content
6	Re-prompt when caller enters an incorrect number in response to announcement 5.	MCCSENG 6	Please dial the number you are calling again now. The number you have dialed is not correct.
7	Re-prompt when timeout occurs after announcement 6.	MCCSENG 7	Please dial the number you are calling.
21	Sign-off announcement when timeout occurs after announcement 7.	MCCSENG 9	
8	Sign-off announcement when caller has entered too many incorrect numbers for a sequence call.	MCCSENG 8	Please hang up and dial zero plus the number you are calling. The number you have dialed is not correct.
15	The number dialed is restricted for sequence calling.	MCCSENG 15	Please hang up and dial direct. This number cannot be dialed as a sequence call.
22	Announcement played when caller has entered a correct number for a sequence call.	MCCSENG 16	
<p>Note 1: MCCS announcement numbers 10 through 14 are reserved for future development.</p> <p>Note 2: MCCS announcement numbers higher than 23 may be used to brand the initial thank-you acknowledgment by carrier or NBEC. The datafill for that is in tables EAMCCSAN and MCCSNBEC.</p>			

Note: for some phrases, the table above lists the same phrase name against several different announcement numbers or scenarios. The table shows the suggested content only once for each phrase name. The operating company can provision different phrases for some of the announcements that share the same phrase name in the table above. To do that,

- First record the new announcement on the DRAM(s) or provision it on the media servers.
- Then add datafill to table DRAMPHRS (using the DRAMREC CI) or ANNAUDID (manually) mapping a new phrase name defined by the operating company to the internal ID provisioned on the announcement server.
- Finally, datafill the new phrase in table ANNPHLST against the CLLI used for MCCS and the new MCCS announcement number.

Note: The table also shows a relatively inefficient scheme for using announcement store. It is based on the pre-recorded announcements that Nortel provides for DRAMs. If you do not plan to use these pre-recorded announcements, you may want to break out some of the sub-phrases that appear multiple times into their own phrases. For example, the sub-phrase “Please hang up and dial zero plus” appears in several different phrases. A separate recording could be created for that, and it could be included in the phrase lists for all of the announcements that begin that way.

If packet announcements are used for MCCS, the scheme for phrase names shown in Table 16 can be efficient if the media server is provisioned with audio sequences for the announcements that contain common phrases. The sequence identifier is then the one datafilled in table ANNPHLST.

If both DRAM and packet members are used for MCCS (or for any other custom announcement type), be aware that the two kinds of members share the same tuple in table ANNPHLST.

Automatic Coin Toll Service

ACTS is a TOPS custom announcement type that can be used for coin call automation and also for the TOPS Time and Charges, Non-coin Notification, and TOPS Coin Tone Generation Test features.

ACTS announcements can be provided by DRAMs or by packet-based media servers in a hybrid solution with IP and ENET fabrics. The Media Server 2010 (MS 2010) and the Universal Audio Server (UAS) are examples of media servers.

For DRAMs, ACTS announcements can take the form of prerecorded phrases on circuit pack NT1X76AE. Alternatively, an operating company can record its own DRAM announcements for ACTS. Use the DRAMREC CI to define the phrases on a DRAM. All ACTS announcements are single-track.

For packetized ACTS announcements, the operating company provides the recordings and provisions them on the media servers using the Announcement Provisioning Server (APS). After that, tables ANNAUDID, CLLI, ANNS, ANNMEMS, and ANNPHLST must also be datafilled in the CM.

ACTS provides no secondary language support.

ACTS pre-defines custom announcement numbers 1 through 23. Through datafill in tables SPIDDB, EAACTSAN and/or ACTSNBEC, the operating company can specify that announcement numbers 24 and higher are to be used to customize the initial correct deposit and overdeposit “thank-you” acknowledgments for coin calls by Service Provider ID, interLATA carrier, or Non-Bell Exchange Company.

ACTS defines certain placeholder phrase names that are datafilled in table ANNPHLST but should not be datafilled in either DRAMPHRS or ANNAUDID. The following table shows the ACTS pre-defined placeholder phrase names.

	Meaning
ACTS_VAR_CHARGE	Amount of money due
ACTS_VAR_CREDIT	Amount of credit from overdeposit
ACTS_VAR_PERIOD	Time duration for charges or for notification
ACTS_VAR_COIN	Denomination of coin to be deposited for coin test feature

In addition to the placeholder phrases, Nortel recommends, but does not require, that the operating company use certain other phrase names for ACTS. These are shown in the following tables. Those phrase names are added to table DRAMPHRS (using the DRAMREC

CI) or ANNAUDID (manually, after provisioning the media servers) before they are datafilled in table ANNPHLST.

The following table shows the pre-defined ACTS announcement numbers, the scenario in which each is used, and the suggested phrase list for each. The table shows the announcement numbers in an order that is logical in terms of call flow, rather than listing them in order by announcement number.

Pre-defined ACTS announcements with suggested phrase lists

Pre-defined announcement number	When this announcement is used	Suggested phrase list (PHLIST field of table ANNPHLST)
1	Initial deposit request	(ACTS_VAR_CHARGE) (ACTS_PLEASE) (ACTS_PAUSE) (ACTS_PLS_DEPOSIT) (ACTS_VAR_CHARGE) (ACTS_FOR_FIRST) (ACTS_VAR_PERIOD)
2	Re-prompt on timeout after announcement 1, no coins entered	(ACTS_PLS_DEPOSIT) (ACTS_VAR_CHARGE)
3	Inter-coin prompt - Re-prompt after inter-coin timeout for initial period	(ACTS_PLS_DEPOSIT) (ACTS_VAR_CHARGE) (ACTS_MORE)
4	Acknowledgement of correct deposit for initial period	(ACTS_THANK_YOU)
5	Acknowledgement of an overdeposit for initial period	(ACTS_THANK_HAVE) (ACTS_VAR_CREDIT) (ACTS_CR_OVERTIME)
6	Notification at end of initial period, for post-paid overtime	(ACTS_ALERT) (ACTS_VAR_PERIOD) (ACTS_END_SIGNAL)

Pre-defined ACTS announcements with suggested phrase lists

Pre-defined announcement number	When this announcement is used	Suggested phrase list (PHLIST field of table ANNPHLST)
7	Charge due deposit request, post-pay, with no previous overdeposit	(ACTS_ALERT) (ACTS_VAR_CHARGE) (ACTS_PLEASE) (ACTS_PAUSE) (ACTS_PLS_DEPOSIT) (ACTS_VAR_CHARGE) (ACTS_FOR_PAST) (ACTS_VAR_PERIOD)
14	Re-prompt on timeout after announcement 7	(ACTS_PLS_DEPOSIT) (ACTS_VAR_CHARGE)
8	Charge due deposit request post-pay, with previous overdeposit	(ACTS_ALERT) (ACTS_VAR_CHARGE) (ACTS_PLEASE) (ACTS_PAUSE) (ACTS_YOU_HAVE) (ACTS_VAR_CREDIT) (ACTS_CREDIT) (ACTS_PLS_DEPOSIT) (ACTS_VAR_CHARGE) (ACTS_MORE) (ACTS_FOR_PAST) (ACTS_VAR_PERIOD)
15	Re-prompt on timeout after prompt 8.	(ACTS_PLS_DEPOSIT) (ACTS_VAR_CHARGE)
20	Charge due deposit request pre-pay, with previous overdeposit	(ACTS_ALERT) (ACTS_VAR_CHARGE) (ACTS_PLEASE) (ACTS_PAUSE) (ACTS_PLS_DEPOSIT) (ACTS_VAR_CHARGE) (ACTS_FOR_NEXT) (ACTS_VAR_PERIOD)
22	Re-prompt on timeout after prompt 20.	(ACTS_PLS_DEPOSIT) (ACTS_VAR_CHARGE)

Pre-defined ACTS announcements with suggested phrase lists

Pre-defined announcement number	When this announcement is used	Suggested phrase list (PHLIST field of table ANNPHLST)
21	First overtime charge prompt, pre-pay, with previous overdeposit.	(ACTS_ALERT) (ACTS_VAR_CHARGE) (ACTS_PLEASE) (ACTS_PAUSE) (ACTS_YOU_HAVE) (ACTS_VAR_CREDIT) (ACTS_CREDIT) (ACTS_PLS_DEPOSIT) (ACTS_VAR_CHARGE) (ACTS_MORE) (ACTS_FOR_NEXT) (ACTS_PERIOD)
23	Re-prompt on timeout after prompt 21.	(ACTS_PLS_DEPOSIT) (ACTS_VAR_CHARGE)
16	Overtime inter-coin prompt (pre-pay or post-pay).	(ACTS_PLS_DEPOSIT) (ACTS_VAR_CHARGE) (ACTS_MORE)
17	Acknowledgement of correct deposit for overtime period (pre-pay or post-pay)	(ACTS_THANK_YOU)
18	Acknowledgement of overdeposit for overtime period (pre-pay or post-pay)	(ACTS_THANK_YOU) (ACTS_VAR_CREDIT) (ACTS_CR_OVERTIME)
9	Time and charges quotation.	(ACTS_ALERT) (ACTS_CHARGES_ARE) (ACTS_VAR_CHARGE) (ACTS_PLUS_TAX) (ACTS_VAR_PERIOD)
19	Repeat time and charges quotation (timeout after announcement 9).	(ACTS_ALERT) (ACTS_CHARGES_ARE) (ACTS_VAR_CHARGE) (ACTS_PLUS_TAX) (ACTS_VAR_PERIOD)
10	Non-coin, customer-requested notification of time.	(ACTS_ALERT) (ACTS_VAR_PERIOD) (ACTS_HAS_ENDED)

Pre-defined ACTS announcements with suggested phrase lists

Pre-defined announcement number	When this announcement is used	Suggested phrase list (PHLIST field of table ANNPHLST)
11	Coin test prompt.	(ACTS_PLS_DEPOSIT) (ACTS_1) (ACTS_VAR_COIN)
12	Coin test failure, also coin test cycle done.	(ACTS_PAUSE) (ACTS_ALERT)
13	Coin test success.	(ACTS_THANK_YOU) (ACTS_VAR_COIN) (ACTS_TST_ENDED)

You do not have to use the exact phrase lists that are suggested in the table above, but it is important that placeholder phrases be datafilled only for the announcements for which they make sense and are shown in the table. For example, it would be an error to datafill placeholder phrase ACTS_VAR_CREDIT in announcement 1, the initial deposit request.

One reason you might want to define your own phrase names would be to play a different “thank-you” acknowledgment for announcement 4 than for announcement 17. To provision different announcements:

- First record the new announcement on the DRAM(s) or provision it on the media servers.
- Then add datafill to table DRAMPHRS (using the DRAMREC CI) or ANNAUDID (manually) mapping a new phrase name defined by the operating company to the internal ID provisioned on the announcement server.
- Finally, datafill the new phrase in table ANNPHLST against the CLLI used for ACTS and the ACTS announcement number.

The following table shows the suggested content for the phrase names from the previous table. It does not include the placeholder phrase names, for which variable substitution occurs before the audio

identifiers are determined. It also does not include the pre-defined phrase names that are substituted for placeholder phrases.

Suggested content for ACTS phrases

Phrase name	Suggested phrase content
ACTS_ALERT	Alerting tone, recording as an announcement
ACTS_PLEASE	'please'
ACTS_PAUSE	two second pause
ACTS_PLS_DEPOSIT	'Please deposit'
ACTS_FOR_FIRST	'for the first'
ACTS_MORE	'more'
ACTS_THANK_YOU	'Thank you'
ACTS_THANK_HAVE	'Thank you. You have'
ACTS_CR_OVERTIME	'credit toward overtime'
ACTS_END_SIGNAL	'has ended. Please signal when through'
ACTS_FOR_PAST	'for the past'
ACTS_YOU_HAVE	'You have'
ACTS_CREDIT	'credit'
ACTS_CHARGES _ARE	'The charges are'
ACTS_PLUS_TAX	'plus tax for'
ACTS_HAS_ENDED	'has ended'
ACTS_1	'one'
ACTS_TST_ENDED	'test has ended'

Note: The ACTS phrases shown in the tables are not the complete list of phrases that must be present in table DRAMPHRS or

ANNAUDID to support ACTS. Tables DRAMPHRS (legacy) and ANNAUDID (packet) must also include certain phrases to support variable substitution. Variable substitution is done differently for packet announcements than for DRAM announcements. Section “Automatic Coin Toll Service” in *DMS-100 Family NA100 Translations Guide* lists all the phrases that must be provisioned on DRAMS if legacy announcements are used for ACTS, and these include the ones used for variable substitution. If packet announcements are used, refer to the section that describes ACTS in section *Configuring packet-based TOPS announcements*, that is documented in *DMS NA100 Family MMP Customer Data Schema Reference Manual*.

Automatic Calling Card Service

The DMS-200 switching unit for the ACCS feature in the Canadian market provides the following announcements.

The announcements are in English and French. The operating company can have entries so that DRAM reports the required announcements in one or two languages.

The DMS-200 selects a free DRAM channel. The DMS-200 delivers the correct announcement during an ACCS call.

Announcements 1 to 17 are standard announcements.
Announcements 17 to 25 are customized announcements.

The DRAM PROM memory cards 1X76AH, English, and 1X76BH, French, are in use.

Input for standard announcements appear in the following examples.

Announcement 1

An initial prompt announcement returns to a subscriber with the tone plus prompt announcement treatment.

ACCS announcement 1

Phrase name	Announcement
ACCSENG1	Please enter your calling card number or dial zero to reach an operator. This is a recording.
ACCSFRE1	Veillez entrer votre numéro de Carte d'appel ou faire le zéro pour joindre le téléphoniste. C'était un message enregistré.

Announcement 2

An error announcement returns to a subscriber that enters a rejected calling card number or makes a keying error.

ACCS announcement 2

Phrase name	Announcement
ACCSENG2	The card number received is not valid. Please enter your card number again.
ACCSFRE2	Le numéro de carte d'appel reçu n'est pas valide. Veuillez entrer à nouveau votre numéro de carte.

Announcement 3

A prompt announcement returns after an error occurs and the system gives the prompt tone.

ACCS announcement 3

Phrase name	Announcement
ACCSENG3	Please enter your card number.
ACCSFRE3	Veuillez entrer votre numéro de carte d'appel.

Announcement 4

A termination failure announcement returns when a subscriber reaches the threshold for keying error or rejected calling card number. The customer must hang up and originate the call again.

ACCS announcement 4

Phrase name	Announcement
ACCSENG4	The card number received is not valid. Please hang up, then dial zero and the number you are calling.
ACCSFRE4	Le numéro de Carte d'appel reçu n'est pas valide. Veuillez raccrocher, puis faire le zéro et composer le numéro que vous voulez joindre.

Announcement 5

A prompt announcement returns for a sequence call.

ACCS announcement 5

Phrase name	Announcement
ACCSENG5	You may place another call now.
ACCSFRE5	Vous pouvez maintenant faire un autre appel.

Announcement 6

An error announcement returns after errors occur in the called number for a sequence call.

ACCS announcement 6

Phrase name	Announcement
ACCSENG6	An incorrect number was dialed. Please redial the number you are calling.
ACCSFRE6	Le numéro que vous avez composé est inexact. Veuillez composer à nouveau le numéro que vous voulez joindre.

Announcement 7

A second error announcement returns when the following two conditions occur:

- the system gives an error announcement
- the subscriber does not enter a new called number for a sequence call

ACCS announcement 7

Phrase name	Announcement
ACCSENG7	Please dial the number you are calling.
ACCSFRE7	Veuillez composer le numéro que vous voulez joindre.

Announcement 8

A termination announcement returns when a subscriber reaches the threshold for a wrong called number in a sequence call.

ACCS announcement 8

Phrase name	Announcement
ACCSENG8	An incorrect number was dialed. Please hang up, then dial zero and the number you are calling.
ACCSFRE8	Le numéro que vous avez composé est inexact. Veuillez raccrocher, puis faire le zéro et composer le numéro que vous voulez joindre.

Announcement 9

A termination error announcement returns when the following two conditions occur:

- the system gives a prompt announcement
- the subscriber does not enter a new calling card number

The announcement applies to a called number for a sequence call.

ACCS announcement 9

Phrase name	Announcement
ACCSENG9	Please hang up, then dial zero and the number you are calling.
ACCSFRE9	Veillez raccrocher, puis faire le zéro et composer le numéro que vous voulez joindre.

Announcement 10

This announcement is a reply to an inward, non-TOPS validation. These validations include accepted calling card number, unrestricted

personal identification number (PIN) and known revenue accounting office (RAO).

ACCS announcement 10

Phrase name	Announcement
ACCSENG10	Valid number, unrestricted PIN, R A O: XXX.
ACCSFRE10	Numéro valide, NIP autorisé, B R C: XXX.

Announcement 11

This announcement is a reply to an inward, non-TOPS validation. These validations include accepted calling card number, restricted PIN and known RAO.

ACCS announcement 11

Phrase name	Announcement
ACCSENG11	Valid number, restricted PIN, R A O: XXX.
ACCSFRE11	Numéro valide, NIP non autorisé, B R C: XXX.

Announcement 12

This announcement is a reply to an inward, non-TOPS validation. Validation of the calling card number does not occur because of a database access problem or failure.

ACCS announcement 12

Phrase name	Announcement
ACCSENG12	Valid number, unrestricted PIN, R A O unavailable.
ACCSFRE12	Numéro valide, NIP autorisé, B R C indisponible.

Announcement 13

This announcement is a reply to an inward, non-TOPS validation. The system rejects the calling card number.

ACCS announcement 13

Phrase name	Announcement
ACCSENG13	Invalid number.
ACCSFRE13	Numéro non valide.

Announcement 14

This announcement is a reply to an inward, non-TOPS validation. The system rejects the calling card.

ACCS announcement 14

Phrase name	Announcement
ACCSENG14	Invalid number.
ACCSFRE14	Numéro non valide.

Announcement 15

A termination announcement returns when you cannot access the database because of technical difficulties or outages. The system blocks the call. The subscriber must try the call again.

This announcement is for possible future use only. The system does not block calls because of database problems. The system processes the calls. Validation does not occur.

ACCS announcement 15

Phrase name	Announcement
ACCSENG15	We are sorry, your call did not go through. Please try your call again. This is a recording.
ACCSFRE15	Des difficultés techniques nous empêchent pour l'instant d'acheminer votre appel. Veuillez composer de nouveau. C'était un message enregistré.

Announcement 16

This announcement returns to a subscriber that enters an accepted calling card number or correct called number for a sequence call.

ACCS announcement 16

Phrase name	Announcement
ACCSENG16	Thank you.
ACCSFRE16	Merci.

Announcement (tone) 17

A tone returns to subscriber to indicate that the subscriber can enter the calling card number.

Tones contain 60 ms DTMF # tone, 941/1477 Hz at -10 dbm. A 940 ms of exponentially decayed dial tone follows this tone immediately. The exponentially decayed dial tone is 440/350 Hz with time constant of 200 ms initially at -10 dbm.

Call Forwarding Remote Access

The operating company can have entries so that the DRAM or Audio Node reports the required announcements in one or two languages.

The DRAM PROM memory cards NT1X76AM, English, and NT1X76BM, French, are in use for DRAM announcements. Configure the Audio Node with the following CFRA phrases for IP-based announcements.

The announcements appear in the following table. The first phrase name, with prefix CFRAE, is the English version. The second phrase name, with prefix CFRAF, is the French equivalent. Phrase names LANGUAGE1 and LANGUAGE2 are language delimiters. The phrase names do not have corresponding recorded announcements.

Announcement 1

Please enter the X digit telephone number to forward, followed by your PIN number.

CFRA Announcement 1

Phrase name	Phrase
CFRAEDNPIN1 CFRAFDNPIN1	Please enter
CFRAEDIGITS CFRAFDIGITS	X digit (see Note)
CFRAEDNPIN2 CFRAFDNPIN2	telephone number to forward, followed by your PIN number.

Note: 'X' can be from 1 to 15.

Announcement 2

Please enter a code to activate or deactivate call forwarding.

CFRA Announcement 2

Phrase name	Phrase
CFRAEFAC CFRAFFAC	Please enter a code to activate or deactivate call forwarding.

Announcement 3

Calls to your number will be forwarded to another number. Please enter the number now.

CFRA Announcement 3

Phrase name	Phrase
CFRAEFWDN CFRAFFWDN	Calls to your number will be forwarded to another number. Please enter the number now.

Announcement 4

Calls to your telephone will be forwarded to XXX XXXX. To confirm this, press one; to forward to a different number, press two; to cancel this, please hang up now.

CFRA Announcement 4

Phrase name	Phrase
CFRAEFWD1 CFRAFFWD1	Calls to your telephone will be forwarded to
ENGVARDNF FREVARDNF	XXX XXXX
CFRAEFWD2 CFRAFFWD2	To confirm this, press one; to forward to a different number, press two; to cancel this, please hang up now.

Announcement 5

Your calls cannot be forwarded to XXX XXXX. Please enter another number now.

CFRA Announcement 5

Phrase name	Phrase
CFRAEERR1 CFRAFERR1	Your calls cannot be forwarded to
ENGVARDNF FREVARDNF	XXX XXXX
CFRAEERR2 CFRAFERR2	Please enter another number now.

Announcement 6

Your calls cannot be forwarded to XXX XXXX.

CFRA Announcement 6

Phrase name	Phrase
CFRAEERR1 CFRAFERR1	Your calls cannot be forwarded to
ENGVARDNF FREVARDNF	XXX XXXX

Custom Local Area Signaling Services

These announcements are a requirement for a switching unit with Residential Enhanced Services (RES), CLASS and directory number (DN) attributes software packages.

The operating company can specify that the DRAM or the Audio Node plays the required announcements in one or two languages.

Two announcement examples for the CND feature appear in the following table. The first phrase name is the English version. The second phrase name is the French equivalent.

Please see other NTPs for more information on a particular CLASS feature.

Announcement 1

Information about incoming calls will now be sent to your telephone.

CLASS Announcement 1

Phrase name	Phrase
CNDEINF CNDFINF	Information about incoming calls
CNDEACT CNDFACT	Will now be sent to your telephone.

Announcement 2

Information about incoming calls will no longer be sent to your telephone.

CLASS Announcement 2

Phrase name	Phrase
CNDEINF CNDFINF	Information about incoming calls
CNDEDACT CNDFDACT	Will no longer be sent to your telephone.

Notification of Time and Charge

The NTC feature provides a notification of time and charge announcement. The feature performs this function after answer and release of the call occurs. This call is the call that requests this service. You can enter spoken phrases and silence pauses in table ANNPHLST.

The NTC is available over Integrated Business Network (IBN) integrated services digital network (ISDN) user part (ISUP) trunks to the Japanese domestic market with NCCI Version 1 or 2 protocols.

You can use the NT1X80AA, 4 min. EDRAM, and NT1X80BA, 16 min. EDRAM, cards to store NTC announcements.

The phrases are available to a switch with the NTC feature. The operating company can have entries so that the EDRAM records the required announcements in nine languages.

Phrase names NTCENG and NTCJPN are language delimiters. The phrase names do not have corresponding recorded announcements.

The phrase names and announcement contents for the required and recommended NTC announcement phrases in different languages appear in the following table. These languages include Japanese, English, Mandarin Chinese, Korean, Malay, Portuguese, Spanish, Tagalog and Thai.

Required phrases for Japanese NTC announcements

Phrase name	Announcement
NTCJPN1	zero
NTCJPN2	ichi
NTCJPN3	ni
NTCJPN4	sann
NTCJPN5	yonn
NTCJPN6	yo
NTCJPN7	go
NTCJPN8	roku
NTCJPN9	nana
NTCJPN10	hachi
NTCJPN11	hatt
NTCJPN12	kyuu
NTCJPN13	ku

Required phrases for Japanese NTC announcements

Phrase name	Announcement
NTCJPN14	jyuu
NTCJPN15	jyutt
NTCJPN16	jyuu ichi
NTCJPN17	jyuu ni
NTCJPN18	jyuu san
NTCJPN19	jyuu yonn
NTCJPN20	jyuu yo
NTCJPN21	jyuu go
NTCJPN22	jyuu roku
NTCJPN23	jyuu nana
NTCJPN24	jyuu hachi
NTCJPN25	jyuu kyu
NTCJPN26	jyuu ku
NTCJPN27	ni jyuu
NTCJPN28	san jyuu
NTCJPN29	yon jyuu
NTCJPN30	go jyuu
NTCJPN31	roku jyuu
NTCJPN32	nana jyuu
NTCJPN33	hachi jyuu
NTCJPN34	kyuu jyuu
NTCJPN35	hyaku
NTCJPN36	pyaku

Required phrases for Japanese NTC announcements

Phrase name	Announcement
NTCJPN37	byaku
NTCJPN38	ni hyaku
NTCJPN39	san byaku
NTCJPN40	yon hyaku
NTCJPN41	go hyaku
NTCJPN42	rop pyaku
NTCJPN43	nana hyaku
NTCJPN44	hap pyaku
NTCJPN45	kyuu hyaku
NTCJPN46	senn
NTCJPN47	zenn
NTCJPN48	ni senn
NTCJPN49	sann zenn
NTCJPN50	yon senn
NTCJPN51	go senn
NTCJPN52	roku senn
NTCJPN53	nana senn
NTCJPN54	has senn
NTCJPN55	kyuu senn
NTCJPN56	ichi man
NTCJPN57	ni man
NTCJPN58	sann man
NTCJPN59	yon man

Required phrases for Japanese NTC announcements

Phrase name	Announcement
NTCJPN60	go man
NTCJPN61	roku man
NTCJPN62	nana man
NTCJPN63	hachi man
NTCJPN64	kyuu man
NTCJPN65	man
NTCJPN66	is sen
NTCJPN67	hyaku man
NTCJPN68	byou
NTCJPN69	zero byou
NTCJPN70	ichi byou
NTCJPN71	ni byou
NTCJPN72	sann byou
NTCJPN73	yonn byou
NTCJPN74	go byou
NTCJPN75	roku byou
NTCJPN76	nana byou
NTCJPN77	hachi byou
NTCJPN78	kyuu byou
NTCJPN79	jyuu byou
NTCJPN80	ni jyuu byou
NTCJPN81	san jyuu byou
NTCJPN82	yonn jyuu byou

Required phrases for Japanese NTC announcements

Phrase name	Announcement
NTCJPN83	go jyu byou
NTCJPN84	funn
NTCJPN85	punn
NTCJPN86	zero funn
NTCJPN87	ip punn
NTCJPN88	ni funn
NTCJPN89	sann punn
NTCJPN90	yonn punn
NTCJPN91	go funn
NTCJPN92	rop punn
NTCJPN93	nana funn
NTCJPN94	hap punn
NTCJPN95	kyuu funn
NTCJPN96	jyu punn
NTCJPN97	ni jyu punn
NTCJPN98	san jyu punn
NTCJPN99	yonn jyu punn
NTCJPN100	go jyu punn
NTCJPN101	jikan
NTCJPN102	ichi jikan
NTCJPN103	ni jikan
NTCJPN104	sann jikan
NTCJPN105	yo jikan

Required phrases for Japanese NTC announcements

Phrase name	Announcement
NTCJPN106	go jikan
NTCJPN107	roku jikan
NTCJPN108	nana jikan
NTCJPN109	hachi jikan
NTCJPN110	ku jikan
NTCJPN111	yen
NTCJPN112	ichi yen
NTCJPN113	ni yen
NTCJPN114	sann yen
NTCJPN115	yo yen
NTCJPN116	go yen
NTCJPN117	roku yen
NTCJPN118	nana yen
NTCJPN119	hachi yen
NTCJPN120	kyuu yen
NTCJPN122	de
NTCJPN123	deshita
NTCJPN124	ate

Recommended phrases for Japanese NTC announcements

Phrase name	Announcement
NTCJPN121	Kochirawa idc desu. Tadaimano kokusaidenwano ryokinwa
NTCJPN125	zerozerorokuni goriyou arigatougozaimashita
NTCJPN126	optional

Recommended phrases for Japanese NTC announcements

Phrase name	Announcement
NTCJPN127	optional
NTCJPN128	optional
NTCJPN129	optional
NTCJPN130	optional

Required phrases for English NTC announcements

Phrase name	Announcement
NTCENG3	hours
NTCENG4	hour
NTCENG5	minutes
NTCENG6	minute
NTCENG7	seconds
NTCENG8	second
NTCENG9	long and cost
NTCENG10	yen
NTCENG11	one
NTCENG13	two
NTCENG14	three
NTCENG15	four
NTCENG16	five
NTCENG17	six
NTCENG18	seven
NTCENG19	eight
NTCENG20	nine

Required phrases for English NTC announcements

Phrase name	Announcement
NTCENG21	ten
NTCENG22	eleven
NTCENG23	twelve
NTCENG24	thirteen
NTCENG25	fourteen
NTCENG26	fifteen
NTCENG27	sixteen
NTCENG28	seventeen
NTCENG29	eighteen
NTCENG30	nineteen
NTCENG31	twenty
NTCENG32	thirty
NTCENG33	forty
NTCENG34	fifty
NTCENG35	sixty
NTCENG36	seventy
NTCENG37	eighty
NTCENG38	ninety
NTCENG39	hundred
NTCENG40	thousand
NTCENG41	million
NTCENG43	zero

Required phrases for Mandarin Chinese NTC announcements

Phrase name	Announcement
NTCCHMAN2	xiaoshi
NTCCHMAN3	fen
NTCCHMAN4	miao
NTCCHMAN6	yuan
NTCCHMAN10	yi

Required phrases for Mandarin Chinese NTC announcements

Phrase name	Announcement
NTCCHMAN11	er
NTCCHMAN12	san
NTCCHMAN13	si
NTCCHMAN14	wu
NTCCHMAN15	liu
NTCCHMAN16	qi
NTCCHMAN17	ba
NTCCHMAN18	jiu
NTCCHMAN19	liang
NTCCHMAN20	shi
NTCCHMAN21	shiyi
NTCCHMAN22	she ir
NTCCHMAN23	shisan
NTCCHMAN24	shis
NTCCHMAN25	shisi
NTCCHMAN26	shiwu
NTCCHMAN27	shiliu
NTCCHMAN28	shiqi
NTCCHMAN29	shiba
NTCCHMAN30	shijiu
NTCCHMAN31	bai
NTCCHMAN32	quian
NTCCHMAN33	wan

Required phrases for Mandarin Chinese NTC announcements

Phrase name	Announcement
NTCCHMAN34	er-shi
NTCCHMAN35	san-shi
NTCCHMAN36	si-shi
NTCCHMAN37	wu-shi
NTCCHMAN38	liu-shi
NTCCHMAN39	qi-shi
NTCCHMAN40	ba-shi
NTCCHMAN41	jiu-shi

Recommended phrases for Mandarin Chinese NTC announcements

Phrase name	Announcement
NTCCHMAN1	Zhe Li Shi IDC. Ning Da De Guo Ji Dian Hua Yong La
NTCCHMAN5	Jin E Shi
NTCCHMAN6	yuan
NTCCHMAN7	Chong Fu Yi Bian
NTCCHMAN8	dui fang hao ma shi
NTCCHMAN9	Gan xie nin shi yong IDC guo ji dian hua. Gang cai nin.

Required phrases for Korean NTC announcements

Phrase name	Announcement
NTCKOREAN3	bun
NTCKOREAN4	cho
NTCKOREAN10	pun

Required phrases for Korean NTC announcements

Phrase name	Announcement
NTCKOREAN11	kong
NTCKOREAN12	il
NTCKOREAN13	i
NTCKOREAN14	sam
NTCKOREAN15	sa
NTCKOREAN16	o
NTCKOREAN17	yuk
NTCKOREAN18	ch'il
NTCKOREAN19	p'all
NTCKOREAN20	ku
NTCKOREAN21	yong
NTCKOREAN22	ship
NTCKOREAN23	ship-il
NTCKOREAN24	ship-i
NTCKOREAN25	ship-sam
NTCKOREAN26	ship-sa
NTCKOREAN27	ship-o
NTCKOREAN28	ship-yuk
NTCKOREAN29	ship-ch'il
NTCKOREAN30	ship-p'ai
NTCKOREAN31	ship-ku
NTCKOREAN32	paek
NTCKOREAN33	ch'on

Required phrases for Korean NTC announcements

Phrase name	Announcement
NTCKOREAN34	man
NTCKOREAN35	i-ship
NTCKOREAN36	sam-ship
NTCKOREAN37	sa-ship
NTCKOREAN38	o-ship
NTCKOREAN39	yuk-ship
NTCKOREAN40	ch'il-ship
NTCKOREAN41	p'ai-ship
NTCKOREAN42	ku-ship
NTCKOREAN43	han
NTCKOREAN44	tu
NTCKOREAN45	se
NTCKOREAN46	ne
NTCKOREAN47	tasot
NTCKOREAN48	yosot
NTCKOREAN49	ilgop
NTCKOREAN50	yodoi
NTCKOREAN51	ahop
NTCKOREAN52	yui
NTCKOREAN53	yui-han
NTCKOREAN54	yui-tu
NTCKOREAN55	yui-se
NTCKOREAN56	yui-ne

Required phrases for Korean NTC announcements

Phrase name	Announcement
NTCKOREAN57	yui-tasot
NTCKOREAN58	yui-yosot
NTCKOREAN59	yui-ilgop
NTCKOREAN60	yui-yodoi
NTCKOREAN61	yui-ahop
NTCKOREAN62	sum
NTCKOREAN63	sumui
NTCKOREAN64	sorun
NTCKOREAN65	mapun
NTCKOREAN66	shun
NTCKOREAN67	yesun
NTCKOREAN68	ilpun
NTCKOREAN69	yudun
NTCKOREAN70	apun

Recommended phrases for Korean NTC announcements

Phrase name	Announcement
NTCKOREAN1	YogninunIDC imnida Yoropunkeso iyonhagci keshimun kucche chonanun
NTCKOREAN5	en imnida
NTCKOREAN6	Tashi maisum dourkessumnida
NTCKOREAN7	en imyo
NTCKOREAN8	purkwa tonhwahayossumnida

Recommended phrases for Korean NTC announcements

Phrase name	Announcement
NTCKOREAN9	IDC nui iyonhayo chusyuso dedani kamsahamnida lgosun nogum teipuinida
NTCKOREAN71	to yogumun

Required phrases for Malay NTC announcements

Phrase name	Announcement
NTCMALAY3	jam
NTCMALAY4	minit
NTCMALAY5	saat
NTCMALAY7	yen
NTCMALAY12	Kosong
NTCMALAY13	Satu
NTCMALAY14	Dua
NTCMALAY15	Tiga
NTCMALAY16	Empat
NTCMALAY17	Lima
NTCMALAY18	Enam
NTCMALAY19	Tujuh
NTCMALAY20	Lapan
NTCMALAY21	Sembilan
NTCMALAY22	Sepuluh
NTCMALAY23	Sebalas
NTCMALAY24	DuaBelas
NTCMALAY25	TigaBelas
NTCMALAY26	EmpatBelas

Required phrases for Malay NTC announcements

Phrase name	Announcement
NTCMALAY27	LimaBelas
NTCMALAY28	EnamBelas
NTCMALAY29	TujuhBelas
NTCMALAY30	LapanBelas
NTCMALAY31	SembilanBelas
NTCMALAY32	DuaPuluh
NTCMALAY33	Seratus
NTCMALAY34	Ratus
NTCMALAY35	Seribu
NTCMALAY36	Ribu
NTCMALAY37	Sejuta
NTCMALAY38	TigaPuluh
NTCMALAY39	EmpatPuluh
NTCMALAY40	LimaPuluh
NTCMALAY41	EnamPuluh
NTCMALAY42	TujuhPuluh
NTCMALAY43	LapanPuluh
NTCMALAY44	SembilanPuluh
NTCMALAY45	Jutah

Recommended phrases for Malay NTC announcements

Phrase name	Announcement
NTCMALAY1	Ini ialah IDC Pangilan antarabangsa yang baru saja anda buat,
NTCMALAY2	selama

Recommended phrases for Malay NTC announcements

Phrase name	Announcement
NTCMALAY6	bayarannya ialah
NTCMALAY8	duilangi
NTCMALAY9	panngilan ke
NTCMALAY10	nombor
NTCMALAY11	Terima kasih kerana menggunakan IDC.

Required phrases for Portuguese NTC announcements

Phrase name	Announcement
NTCPORG2	horas
NTCPORG3	minutos
NTCPORG4	e
NTCPORG5	segundos
NTCPORG6	hora
NTCPORG7	minuto
NTCPORG8	segundo
NTCPORG10	iene
NTCPORG11	ienes
NTCPORG15	zero
NTCPORG16	um
NTCPORG17	dois
NTCPORG18	tres
NTCPORG19	quatro
NTCPORG20	cinco
NTCPORG21	seis

Required phrases for Portuguese NTC announcements

Phrase name	Announcement
NTCPORTG22	sete
NTCPORTG23	oto
NTCPORTG24	nove
NTCPORTG25	des
NTCPORTG26	onze
NTCPORTG27	doze
NTCPORTG28	treze
NTCPORTG29	quatorze
NTCPORTG30	quinze
NTCPORTG31	dessesseis
NTCPORTG32	dessessete
NTCPORTG33	dezoto
NTCPORTG34	deznove
NTCPORTG35	vinte
NTCPORTG36	vinte e
NTCPORTG37	trinta
NTCPORTG38	trinta e
NTCPORTG39	quarenta
NTCPORTG40	quarenta e
NTCPORTG41	cinquenta
NTCPORTG42	cinquenta e
NTCPORTG43	sessenta
NTCPORTG44	sessenta e

Required phrases for Portuguese NTC announcements

Phrase name	Announcement
NTCPORTG45	setenta
NTCPORTG46	setenta e
NTCPORTG47	otenta
NTCPORTG48	otenta e
NTCPORTG49	noventa
NTCPORTG50	noventa e
NTCPORTG51	cem
NTCPORTG52	cemto
NTCPORTG53	cemto e
NTCPORTG54	duzentos
NTCPORTG55	duzentos e
NTCPORTG56	trezentos
NTCPORTG57	trezentos e
NTCPORTG58	quatrocentos
NTCPORTG59	quatrocentos e
NTCPORTG60	quinhentos
NTCPORTG61	quinhentos e
NTCPORTG62	seiscentos
NTCPORTG63	seiscentos e
NTCPORTG64	setecentos
NTCPORTG65	setecentos e
NTCPORTG66	otocentos
NTCPORTG67	otoscentos e

Required phrases for Portuguese NTC announcements

Phrase name	Announcement
NTCPORTG68	novecentos
NTCPORTG69	novecentos e
NTCPORTG70	mil
NTCPORTG71	mil e
NTCPORTG72	mihao de
NTCPORTG73	mihao e
NTCPORTG74	mihao
NTCPORTG75	mihoes de
NTCPORTG76	mihoes e
NTCPORTG77	mihoes
NTCPORTG78	de
NTCPORTG79	uma
NTCPORTG80	duas
NTCPORTG81	duzentas

Recommended phrases for Portuguese NTC announcements

Phrase name	Announcement
NTCPORTG1	Aqui e a IDC. A chamada internacional qua acaba de ser feat tave a duracao de
NTCPORTG9	a custou
NTCPORTG12	Repatimos
NTCPORTG13	a camada toi para.
NTCPORTG14	Agradecemos por utilizar a IDC.

Required phrases for Spanish NTC announcements

Phrase name	Announcement
NTCSPAIN2	horas
NTCSPAIN3	minutos
NTCSPAIN4	segundos
NTCSPAIN5	hora
NTCSPAIN6	minuto
NTCSPAIN7	segundo
NTCSPAIN9	yenes
NTCSPAIN10	yen
NTCSPAIN15	cero
NTCSPAIN16	uno
NTCSPAIN17	dos
NTCSPAIN18	tres
NTCSPAIN19	cuatro
NTCSPAIN20	cinco
NTCSPAIN21	seis
NTCSPAIN22	siete
NTCSPAIN23	ocho
NTCSPAIN24	nueve
NTCSPAIN25	un
NTCSPAIN26	diez
NTCSPAIN27	once
NTCSPAIN28	doce
NTCSPAIN29	trece

Required phrases for Spanish NTC announcements

Phrase name	Announcement
NTCSPAIN30	catorce
NTCSPAIN31	quince
NTCSPAIN32	dieciseis
NTCSPAIN33	diecisiete
NTCSPAIN34	dieciocho
NTCSPAIN35	diecinueve
NTCSPAIN36	viente
NTCSPAIN37	vientun
NTCSPAIN38	trienta
NTCSPAIN39	y
NTCSPAIN40	trienta y
NTCSPAIN41	cuarenta
NTCSPAIN42	cuarenta y
NTCSPAIN43	cinquenta
NTCSPAIN44	cinquenta y
NTCSPAIN45	sesenta
NTCSPAIN46	sesenta y
NTCSPAIN47	setenta
NTCSPAIN48	setenta y
NTCSPAIN49	ochenta
NTCSPAIN50	ochenta y
NTCSPAIN51	noventa
NTCSPAIN52	noventa y

Required phrases for Spanish NTC announcements

Phrase name	Announcement
NTCSPAIN53	cien
NTCSPAIN54	ciento
NTCSPAIN55	doscientos
NTCSPAIN56	trescientos
NTCSPAIN57	cuatrocientos
NTCSPAIN58	quinientos
NTCSPAIN59	seiscientos
NTCSPAIN60	setecientos
NTCSPAIN61	ochocientos
NTCSPAIN62	novecientos
NTCSPAIN63	mil
NTCSPAIN64	million de
NTCSPAIN65	vientidos
NTCSPAIN66	vientitres
NTCSPAIN67	vienticuatro
NTCSPAIN68	vienticinco
NTCSPAIN69	vientiseis
NTCSPAIN70	vientisiete
NTCSPAIN71	vientiocho
NTCSPAIN72	vientinueve
NTCSPAIN73	million
NTCSPAIN74	milliones de
NTCSPAIN75	milliones

Required phrases for Spanish NTC announcements

Phrase name	Announcement
NTCSPAIN76	una
NTCSPAIN77	vientiuna

Recommended phrases for Spanish NTC announcements

Phrase name	Announcement
NTCSPAIN1	Habia IDC. La tamada internacional que acaba de realizar duro
NTCSPAIN8	de duracion
NTCSPAIN11	Repetimos
NTCSPAIN12	y ei importe es de
NTCSPAIN13	al numero.
NTCSPAIN14	Gracias por usar IDC. Esta Es una grabacion.

Required phrases for Tagalog NTC announcements

Phrase name	Announcement
NTCTGALO2	oras
NTCTGALO3	minuto
NTCTGALO4	segundo
NTCTGALO6	yen
NTCTGALO13	sero
NTCTGALO14	one
NTCTGALO15	two
NTCTGALO16	three
NTCTGALO17	four
NTCTGALO18	five

Required phrases for Tagalog NTC announcements

Phrase name	Announcement
NTCTGALO19	six
NTCTGALO20	seven
NTCTGALO21	eight
NTCTGALO22	nine
NTCTGALO23	isang
NTCTGALO24	dalawang
NTCTGALO25	tatlong
NTCTGALO26	apatna
NTCTGALO27	limang
NTCTGALO28	animna
NTCTGALO29	pitong
NTCTGALO30	walong
NTCTGALO31	slyamna
NTCTGALO32	sampung
NTCTGALO33	labing-isang
NTCTGALO34	labin-dalawang
NTCTGALO35	labin-tatlong
NTCTGALO36	labing-apatna
NTCTGALO37	labin-limang
NTCTGALO38	labing-animna
NTCTGALO39	labim-pitong
NTCTGALO40	labing-walong
NTCTGALO41	labin-siyamna

Required phrases for Tagalog NTC announcements

Phrase name	Announcement
NTCTGALO42	dalawampung
NTCTGALO43	dalawampu't
NTCTGALO44	tatlumpung
NTCTGALO45	tatlumpu't
NTCTGALO46	apatnapung
NTCTGALO47	apatnapu't
NTCTGALO48	limampung
NTCTGALO49	limampu't
NTCTGALO50	animnapung
NTCTGALO51	animnapu't
NTCTGALO52	pitumpung
NTCTGALO53	pitumpu't
NTCTGALO54	walumpung
NTCTGALO55	walumpu't
NTCTGALO56	siyamnapung
NTCTGALO57	siyamnapu't
NTCTGALO58	daang
NTCTGALO59	daa't
NTCTGALO60	raang
NTCTGALO61	raa't
NTCTGALO62	libong
NTCTGALO63	libo't

Required phrases for Tagalog NTC announcements

Phrase name	Announcement
NTCTGALO64	milyong
NTCTGALO65	milyon at

Recommended phrases for Tagalog NTC announcements

Phrase name	Announcement
NTCTGALO1	Ito pong IDC. Ang inyong international call kanina ay
NTCTGALO6	at umobot ng
NTCTGALO7	Uullin ko po
NTCTGALO8	ang inyo pong tawag
NTCTGALO9	sa
NTCTGALO10	numerong
NTCTGALO11	Maraming saiamat po sa inyong paggamit ng IDC
NTCTGALO12	Ito po ay recording

Required phrases for Thai NTC announcements

Phrase name	Announcement
NTCTHAI2	chuamong
NTCTHAI3	naathii
NTCTHAI4	winaathii
NTCTHAI6	yen
NTCTHAI12	Soon
NTCTHAI13	Nurung
NTCTHAI14	Too
NTCTHAI15	Saam

Required phrases for Thai NTC announcements

Phrase name	Announcement
NTCTHAI16	Sii
NTCTHAI17	Haa
NTCTHAI18	Hok
NTCTHAI19	Jed
NTCTHAI20	Paad
NTCTHAI21	Gao
NTCTHAI22	Song
NTCTHAI23	Sip
NTCTHAI24	SipEd
NTCTHAI25	SipSong
NTCTHAI26	SipSaam
NTCTHAI27	SipSii
NTCTHAI28	SipHaa
NTCTHAI29	SipHok
NTCTHAI30	SipJed
NTCTHAI31	SipPaad
NTCTHAI32	SipGao
NTCTHAI33	YiiSip
NTCTHAI34	Ed
NTCTHAI35	Rooi
NTCTHAI36	Phan
NTCTHAI37	Murn
NTCTHAI38	Saan

Required phrases for Thai NTC announcements

Phrase name	Announcement
NTCTHAI39	Laan
NTCTHAI40	SaamSip
NTCTHAI41	SiiSip
NTCTHAI42	HaaSip
NTCTHAI43	HokSip
NTCTHAI44	JedSip
NTCTHAI45	PaadSip
NTCTHAI46	GaoSip

Recommended phrases for Thai NTC announcements

Phrase name	Announcement
NTCTHAI1	Thii nii IDC than dai chai boorikan thoorasap rawaang prathet pen weelaa
NTCTHAI5	pen ngen
NTCTHAI7	Yam than daai chai boorikan thoorasap rawaang prathet
NTCTHAI8	pai yang
NTCTHAI9	maalieek thoorasap
NTCTHAI10	pen weelaa
NTCTHAI11	khoo khoobphrakhun thii chai boorikan khoong IDC le niikhuu tapebanthuksiang

Silence phrases for NTC

Phrase name	Time duration
NTCSLNC250MS	250 ms

Silence phrases for NTC

Phrase name	Time duration
NTCSLNC500MS	500 ms
NTCSLNC1SEC	1 s

The NTCSLNC500MS is the only compound phrase. A phrase assignment is not a requirement.

Station Programmable PIN (SPP)

This feature allows subscribers to change the PIN from the telephone through a feature access code. The SPP assignment can occur for each customer group. Possible SPP announcements that the operating company can custom record, appear in the following examples. Northern Telecom (Nortel) recommends announcement 1 for phrase SPPANNC1. Refer to section 7 of the *DRAM and EDRAM Guide* for additional information about how to create customized recordings on a DRAM. Configure the Audio Node with the following SPP phrases for IP-based announcements.

The phrase names and announcements for this feature appear in the following table.

SPP announcements

Phrase name	Phrase
SPPANNC1	Please enter the feature access code for the PIN you wish to change.
SPPANNC2	Please enter your PIN number.
SPPANNC3	Please enter a NEW PIN number.
SPPANNC4	Please re-enter the NEW PIN number.
SPPANNC5	The NEW PIN number has been updated.
SPPANNC6	You have entered an incorrect PIN number.
SPPANNC7	You have exceeded the number of retries. Please hang up and try again.

SPP announcements

Phrase name	Phrase
SPPANNC8	Call Forwarding Remote Access
CFRAFRST	Access to this feature is prohibited until you change your PIN number. The PIN number change must be made from your own phone.

Subscriber Activated Call Blocking (SACB)

This feature allows a subscriber to control originations from the line of the subscriber. To control originations, the subscribers can identify Call Classes that restrict completion to specified dialed numbers. Enter Call Classes in Table SACB. Specify the Call Classes to restrict when you add the SACB option to the line of a subscriber during a SERVORD session.

Use an access code to activate and deactivate the SACB option. To override active SACB blocking, provide a PIN in response to the SACB blocking announcement.

Examples of possible SACB announcements, that the operating company can custom record, appear in the following table. Refer to section 7 of the *DRAM and EDRAM Guide* for additional information about how to create customized recordings on a DRAM. Configure the Audio Node with the following SACB phrases for IP-based announcements.

The phrase names and recommended announcements for this feature appear in the following table.

SACB announcements

Phrase name	Phrase
SACBANNC1	Please enter your PIN number.
SACBANNC2	The subscriber call blocking feature is activated. To override this restriction, please enter your PIN number.
SACBANNC3	The subscriber call blocking feature has been activated.
SACBANNC4	The subscriber call blocking feature has been deactivated.

SACB announcements

Phrase name	Phrase
SACBANNC5	You have entered an incorrect PIN number.
SACBANNC6	Please re-enter your PIN number.
SACBANNC7	You have exceeded the number of retries. Please hang up and try again.
SPPANNC9	Subscriber Activated Call Blocking

CS-1R announcements

The Capability Set 1 Revised (CS-1R) announcements are Intelligent Network (IN) custom announcements. Table ANNPHLST defines the phrases that are part of CS-1R announcements. Each CS-1R announcement can contain fixed phrases, or fixed and variable phrases.

Fixed phrases

Fixed phrases are prerecorded announcement phrases. Refer to *Digital Recorded Announcement Machine DRAM and EDRAM Guide* for information on prerecorded announcements.

Variable phrases

Variable phrase identifiers announce variable digits and variable integers in English or Mandarin. The following variable phrase identifiers are place containers in CS-1R announcements:

- ENGLISHVARDIG
- ENGLISHVARINT
- MANDARINVARDIG
- MANDARINVARINT

The service control point (SCP) supplies digits or integer data. This data maps to the phrase identifiers. Each announcement in table ANNPHLST can contain zero to five variable phrases.

These digits or integer data map to one of these phrase identifiers. Each announcement in table ANNPHLST can contain a maximum of five variable phrases. Each variable digit, ENGLISHVARDIG or MANDARINVARDIG, supports a maximum of 32 digits. Each integer digit, ENGLISHVARINT or MANDARINVARINT, supports an integer value of zero to 2 147 483 647.

The DRAMREC utility fills variable digit phrases with a group of variable phrases during call processing. The DRAMREC uses the digits the SCP supplies as input. The DRAMREC provides a list of phrases as output. Refer to *Digital Recorded Announcement Machine DRAM and EDRAM Guide* for information of DRAMREC.

Mandarin phrases that require to be pre-recorded to support variable announcements

Phrase name	Announcement
LANG_CAN	Play the variable announcement in Cantonese
IN_ZERO_CHNMAN	Mandarin '0'
IN_ONE_CHNMAN	Mandarin '1'
IN_TWO_CHNMAN	Mandarin '2'
IN_THREE_CHNMAN	Mandarin '3'
IN_FOUR_CHNMAN	Mandarin '4'
IN_FIVE_CHNMAN	Mandarin '5'
IN_SIX_CHNMAN	Mandarin '6'
IN_SEVEN_CHNMAN	Mandarin '7'
IN_EIGHT_CHNMAN	Mandarin '8'
IN_NINE_CHNMAN	Mandarin '9'
IN_SHI_CHNMAN	Mandarin '10'
IN_BAI_CHNMAN	Mandarin 'bai (hundred)
IN_QIAN_CHNMAN	Mandarin 'qian' (thousand)
IN_WAN_CHNMAN	Mandarin 'wan' (ten thousand)

Mandarin phrases that require to be pre-recorded to support variable announcements

Phrase name	Announcement
IN_YUAN_CHNMA N	Mandarin 'yuan' (RMB unit)
IN_JIAO_CHNMAN	Mandarin 'jiao' (RMB subunits)
IN_FEN_CHNMAN	Mandarin 'fen' (RMB subunits)
IN_NIAN_CHNMAN	Mandarin 'nian' (year)
IN_YUE_CHNMAN	Mandarin 'yue' (month)
IN_RI_CHNMAN	Mandarin 'ri' (day)
IN_HOUR_CHNMA N	Mandarin 'shi' (hour)
IN_MINUTE_CHNM AN	Mandarin 'fen' (minute)
IN_SECOND_CHN MAN	Mandarin 'miao' (second)

Cantonese phrases that require to be pre-recorded to support variable announcements

Phrase name	Announcement
IN_ZERO_CHNCA N	Cantonese '0'
IN_ONE_CHNCAN	Cantonese '1'
IN_TWO_CHNCAN	Cantonese '2'
IN_THREE_CHNC AN	Cantonese '3'
IN_FOUR_CHNCA N	Cantonese '4'
IN_FIVE_CHNCAN	Cantonese '5'
IN_SIX_CHNCAN	Cantonese '6'

Cantonese phrases that require to be pre-recorded to support variable announcements

Phrase name	Announcement
IN_SEVEN_CHNCAN	Cantonese '7'
IN_EIGHT_CHNCAN	Cantonese '8'
IN_NINE_CHNCAN	Cantonese '9'
IN_SHI_CHNCAN	Cantonese '10'
IN_BAI_CHNCAN	Cantonese 'bai (hundred)
IN_QIAN_CHNCAN	Cantonese 'qian' (thousand)
IN_WAN_CHNCAN	Cantonese 'wan' (ten thousand)
IN_YUAN_CHNCAN	Cantonese 'yuan' (RMB unit)
IN_JIAO_CHNCAN	Cantonese 'jiao' (RMB subunits)
IN_FEN_CHNCAN	Cantonese 'fen' (RMB subunits)
IN_NIAN_CHNCAN	Cantonese 'nian' (year)
IN_YUE_CHNCAN	Cantonese 'yue' (month)
IN_RI_CHNCAN	Cantonese 'ri' (day)
IN_HOUR_CHNCAN	Cantonese 'shi' (hour)
IN_MINUTE_CHNCAN	Cantonese 'fen' (minute)
IN_SECOND_CHNCAN	Cantonese 'miao' (second)

INDIGIT Phrases

Before GL04, INDIGIT phrases were in use. These phrases must now change to common phrases. The common phrases appear in the following table.

Change INDIGIT Phrases to Common Phrases

Change from	Change to	
<i>INDIGIT Phrase</i>	<i>ENGLISH Phrases</i>	<i>MANDARIN Phrases</i>
INDIGIT	ENGLISHVARDIG	MANDARINVARDIG
INDIG0	CMNENG	CMNMDN
INDIG1	CMNENG	CMNMDN
INDIG2	CMNENG	CMNMDN
INDIG3	CMNENG	CMNMDN
INDIG4	CMNENG	CMNMDN
INDIG5	CMNENG	CMNMDN
INDIG6	CMNENG	CMNMDN
INDIG7	CMNENG	CMNMDN
INDIG8	CMNENG	CMNMDN
INDIG9	CMNENG	CMNMDN

Provisioning requirements

Table ANNS defines the characteristics of each CS-1R announcement. The ANTYPE field in table ANNS must be IN for the CS-1R announcement software to function. The CS-1R announcements are visible if CS-1R software is active in the load.

Separate DRAMs are a requirement if more than one language is in use to record variable announcements. Refer to *Digital Recorded Announcement Machine DRAM and EDRAM Guide* for additional information.

The system must record the following announcement phrase identifiers.

Required phrases for English CS-1R announcements

Phrase name	Announcement
CMNENG0	zero
CMNENG1	one
CMNENG2	two
CMNENG3	three
CMNENG4	four
CMNENG5	five
CMNENG6	six
CMNENG7	seven
CMNENG8	eight
CMNENG9	nine
CMNENG10	ten
CMNENG11	eleven
CMNENG12	twelve
CMNENG13	thirteen
CMNENG14	fourteen
CMNENG15	fifteen
CMNENG16	sixteen
CMNENG17	seventeen
CMNENG18	eighteen
CMNENG19	nineteen
CMNENG20	twenty
CMNENG21	thirty

Required phrases for English CS-1R announcements

Phrase name	Announcement
CMNENG22	forty
CMNENG23	fifty
CMNENG24	sixty
CMNENG25	seventy
CMNENG26	eighty
CMNENG27	ninety
CMNENG28	hundred
CMNENG29	thousand
CMNENG30	million
CMNENG31	billion

Recommended phrases for Mandarin CS-1R announcements

Phrase name	Announcement
CMNMDN0	ling
CMNMDN1	yi
CMNMDN2	er
CMNMDN3	san
CMNMDN4	si
CMNMDN5	wu
CMNMDN6	liu
CMNMDN7	qi
CMNMDN8	ba
CMNMDN9	jiu
CMNMDN10	shi

Recommended phrases for Mandarin CS-1R announcements

Phrase name	Announcement
CMNMDN11	shiyi
CMNMDN12	shi'er
CMNMDN13	shisan
CMNMDN14	shishi
CMNMDN15	shiwu
CMNMDN16	shiliu
CMNMDN17	shiqi
CMNMDN18	shiba
CMNMDN19	shijiu
CMNMDN20	er-shi
CMNMDN21	san-shi
CMNMDN22	si-shi
CMNMDN23	wu-shi
CMNMDN24	liu-shi
CMNMDN25	qi-shi
CMNMDN26	ba-shi
CMNMDN27	jiu-shi
CMNMDN28	bai
CMNMDN29	quain
CMNMDN30	wan
CMNMDN31	yi
CMNMDN32	liang

CS-1R Pre-Paid Services (introduction)

This feature is currently restricted to Succession networks, which use the CS2K platform and the Universal Audio Server (UAS) peripheral.

An Intelligent Network Application Part (INAP) operation may include numerical data to be formatted into an announcement on the receiving switch. This feature provides a means for INAP to play a variable announcement of service charge, in specified language(s) and currency, on a per-service basis.

Refer to the end of the ANNPHLST table description for a detailed discussion of this feature.

Datavill examples

The figure that follows shows basic sample datavill for table ANNPHLST with phrases for both broadcast (BLDNANN) and custom (CFRAANN) type.

MAP display example for table ANNPHLST

```
ANNPHKEY PHSLIST
-----
BLDNANN 3 (BLDNPHR1) $
BLDNANN 4 (BLDNPHR2) $
CFRAANN 1 (LANGUAGE1) (CFRAEDNPIN1) (CFRAEDIGITS) (CFRAEDNPIN2) $
CFRAANN 2 (LANGUAGE1) (CFRAEFAC) $
BOTTOM
```

An example of the standard announcements for MCCS appears in the following figure. The MCCSTOPS18 to 23 are available in switching units with the TOPS alternate announcement software package.

An example of the standard announcements for ACTS appears in the following figure. The ACTSTOPS14 to 19 are available in switching units with the TOPS alternate announcement software package.

An example of the standard bilingual announcements for ACCS appears in the following figure. The English version of the announcements appears first.

An example of customized bilingual announcements for ACCS appears in the following figure. The French version of the announcements appears first.

An example of customized bilingual announcements for the CFRA feature appears in the following figure. The English version of the announcements appears first.

```
ANNPHKEY  
  
PHSLIST  
  
-----  
  
CFRAANN 1  
  LANGUAGE1 CFRAEDNPIN1 CFRAEDIGITS CFRAEDNPIN2 LANGUAGE2  
CFRAFDNPIN1 CFRAFDIGITS CFRAFDNPIN2 $  
CFRAANN 2  
  LANGUAGE1 CFRAEFAC LANGUAGE2 CFRAFFAC $  
CFRAANN 3  
  LANGUAGE1 CFRAEFWDN LANGUAGE2 CFRAFFWDN $  
CFRAANN 4  
  LANGUAGE1 CFRAEFDW1 ENGVARDNF CFRAEFDW2 LANGUAGE2 CFRAFFDW1  
FREVARDNF CFRAFFWD2 $  
CFRAANN 5  
  LANGUAGE1 CFRAEERR1 ENGVARDNF CFRAEERR2 LANGUAGE2 CRRAFERR1  
FREVARDNF CFRAFERR2 $  
CFRAANN 6  
  LANGUAGE1 CFRAEERR1 ENGVARDNF LANGUAGE2 CFRAFERR1 FREVARDNF $
```

An example of customized bilingual announcements for the CLASS feature appears in the following figure. The English version of the announcements appears first.

An example of CS-1R announcements appears in the following figure.

ANNPKKEY	PHSLIST
CS1ANN 1 (ENGLISHVARDIG) \$	
CS1ANN 2 (PHRASE1) (MANDARINVARINT) \$	
CS1ANN 3 (ENGLISHVARDIG) (ENGLISHVARINT) \$	
CS1ANN 4 (CMNMDN7) (MANDARINVARDIG) (PHRASE2) \$	
CS1ANN 5 (PHRASE3) (MANDARINVARDIG) (PHRASE2) (MANDARINVARDIG) (CMNMDN3) \$	

CS-1R Pre-Paid Services

This feature is currently restricted to Succession networks, which use the CS2K platform and the Universal Audio Server (UAS) peripheral.

An Intelligent Network Application Part (INAP) operation may include numerical data to be formatted into an announcement on the receiving switch. This feature provides a means for INAP to play a variable announcement of service charge, in specified language(s) and currency, on a per-service basis.

Functionality and datafill: languages

This feature changes the way in which language is specified for Intelligent Network (IN) variable announcements. The feature introduces ISO 639-2 codes as language discriminators, and also introduces INAP support for Chinese, Japanese, German, Turkish and Italian languages.

In MMP, there is a separate IN variable component for each supported language. For example, the variable ENG_IN_VAR specifies an announcement in English. The mapping to a specific announcement is achieved through datafill in table AINANNS.

The new functionality separates the language specification from the declaration of the IN variable. Thus 'ENG_IN_VAR', for example, is replaced by the language discriminator 'ENG' and the INAP variable part placeholder 'IN_VAR'.

Datafill example

Typical datafill in tables AINANNS and ANNPHLST for an announcement in English is shown below.

```
TABLE AINANNS
7005 IN_VAR_ANNC 5
TABLE ANNPHLST
IN_VAR_ANNC 5 (ENG) (IN_VAR)$
```

Supported UAS languages

The table below identifies the languages and the corresponding ISO 639-2 language code that the UAS can support.

The 'INAP Support - CS2K' column indicates whether the language is supported for INAP variable announcements in the SN05 release. Languages that are not currently supported can be datafilled, but will have no effect.

For reference the 'INAP Support - MMP' column identifies whether the language is available on the MMP platform (through the use of the original 'ENG_IN_VAR' style datafill).

Supported UAS ISO 639-2 Announcement Languages

Language	ISO 639-2 Terminology Code	Implemented in UAS Rel. #	INAP Support	
			MMP	CS2K
Czech	CES	UAS 06	No	No
German	DEU	UAS 03	No	Yes
Greek	ELL	UAS 06	No	No
English	ENG	UAS 2.1	Yes	Yes
French	FRA	UAS 03	Yes	Yes
Hebrew	HEB	UAS 06	No	No

Supported UAS ISO 639-2 Announcement Languages

Language	ISO 639-2 Terminology Code	Implemented in UAS Rel. #	INAP Support	
			MMP	CS2K
Italian	ITA	UAS 03	No	Yes
Japanese	JPN	UAS 05	No	Yes
Korean	KOR	UAS 05	No	No
Malay	MAY	UAS 05	No	No
Netherlands Dutch	NLD	UAS 03	No	No
Portuguese	POR	UAS 04	Yes	Yes
Spanish	SPA	UAS 2.1	Yes	Yes
Tagalog	TGL	UAS 05	No	No
Thai	THA	UAS 05	No	No
Turkish	TUR	UAS 06	No	Yes
Vietnamese	VIE	UAS 06	No	No
Chinese	ZHO	UAS 05	No	Yes

Functionality and datafill: currencies

This feature introduces ISO 4217 currency identifiers to table ANNPHLST. Currencies are datafilled as a three letter ASCII identifier. For example, the ISO 4217 identifier for GB Pounds is 'GBP'.

The identifier specifies the currency to be used for all subsequent variable phrase(s), until either the end of the announcement, or until another currency identifier is specified.

Datafill example: single-language, single-currency announcement

Typical datafill in tables AINANNS and ANNPHLST for an announcement in English, and a currency of GB Pounds, is shown below. The announcement resulting from this datafill is "Twelve pounds and fifty pence".

Datafill example: two-language, two-currency announcement

Typical datafill in tables AINANNS and ANNPHLST is shown below for:

- an announcement in English, with currency GB Pounds, followed by
- the equivalent announcement in French, with currency Euros

The combined announcement resulting from this datafill is “Twelve pounds and fifty pence, vingt euros et cinquante quatre cents”.

```
TABLE AINANNS
```

```
7007 IN_VAR_ANNC 7
```

```
TABLE ANNPHLST
```

```
IN_VAR_ANNC 6 (ENG) (GBP) (IN_VAR) (FRE) (EUR) (IN_VAR)$
```

Supported currency codes

The table below lists the ISO 4217 currency codes that are added to ANNPHLST to support the feature.

Supported Currency Codes

Country	Currency	ISO Code
Austria	Schilling	ATS
Australia	Australian Dollar	AUD
Brazil	Brazilian Real	BRL
Chile	Chilean Peso	CLP
China	Yuan Renminbi	CNY
Germany	Deutsche Mark	DEM

Supported Currency Codes

Country	Currency	ISO Code
Spain	Spanish Peseta	ESP
European Monetary Union	EU Euro	EUR
France	French Franc	FRF
United Kingdom	UK Sterling	GBP
Guyana	Guyana Dollar	GYD
Hong Kong	Hong Kong Dollar	HKD
Haiti	Haitian Gourde	HTG
Hungary	Hungarian Forint	HUF
Ireland	Irish Pound	IEP
Japan	Japanese Yen	JPY
Morocco	Moroccan Dirham	MAD
Mexico	Mexican Peso	MXN
Mexico MTX	Mexican Peso	MXN
Peru	Nuevo Sol	PEN
Poland	Polish Zloty	PLN
CIS	Russian Ruble	RUR
Turkey	Turkish Lira	TRL
North America	US Dollar	USD
Caribbean Exp. Proj.	East Caribbean Dollar	XCD

Additional information

Information on how to assign the SIT in table ANNPHLST with commands SITLOAD and ASSIGN appears in this section. The information is for switches with PROM and RAM cards.

Machine detectable encodings (SIT)

The system treats calls that route to an announcement as completed calls. The system provides voice responses for these calls are provided as a result of analysis of machine detectable encodings by call disposition equipment. A machine detectable encoding provides a

quicker call disposition if the encoding is at the beginning of each recorded announcement. These machine detectable encodings are special information tones (SIT). The maximum number of SITs is 32. Each SIT has three different frequencies and durations. The SIT indicate that a machine-generated announcement follows.

This feature is optional.

SITs in PROM or RAM speech cards

A DRAM can store SITs in PROM or RAM speech cards.

The PROM speech cards can store all data for SITS.

Some switches can only use RAM speech cards. These switches do not require standard Bell Canada format announcements of PROM cards. The SIT data can be stored in central control (CC) data store. The data can be downloaded to the RAM speech cards when a switch equipped only with RAM cards goes in service. The additional download is a requirement if RAM cards memory is lost. The download time is approximately 3 min.

The CC instructs the DRAM to play the SIT and the announcement for a call that terminates on an announcement.

The DRAMREC commands ASSIGN and RECORD supply the CC with information on each announcement phrase in the DRAM. The ASSIGN command provides information to the CC on phrases the PROM cards store. The RECORD command has parameters that provide information on phrases to record on RAM cards. These commands do not identify the phrases with specified SITs.

The SITs can download from data store to RAM cards. This download can only occur in switches that do not have PROM cards.

Each RAM card contains a 128-kbyte block that includes four kilobytes of menu and SIT data. The 124 kilobytes that remain store speech data. The download requires two RAM cards for the SIT tones. The menu data that relates to the SITs can be split. One half of the SITS is in one RAM card. The other half of the SITS is in another RAM card. The SIT data is compressed to save recording space. The same SIT data must be stored in both cards. If only one RAM card stores the SIT data, store for 8 s of speech tones on that card are removed to accommodate all the SIT phrase identifiers.

Module DRAMSIT downloads SIT data from the CC store to the RAM speech store of the DRAM. The command interpreter (CI) command SITLOAD initiates the download of SITs. The SIT tone data is a data

string in the CC data store. This data is downloaded on the first two available RAM cards in table DRAMS. The first 16 SITs are on the first RAM card. The next 16 SITs are on the second RAM card.

When the download completes, a message that indicates the completed download appears to the user.

Use the ASSIGN command to assign phrases to PROM cards. Use the ASSIGN command to assign SIT phrase identifiers to PROM and RAM cards.

The DRAM announcement phrases in each track of a multitrack announcement are the same length. The duration of a SIT is 1 s. The SIT is only on the primary language track. The secondary language track is 1 s shorter than the primary language track. The two tracks next to each other go out of synchronization because of this difference. To overcome this problem, a 1 s SILENCE phrase is assigned on a PROM card or a RAM card. The phrase plays at the beginning of each of the tracks that are next to each other.

SITLOAD command

The SITLOAD command downloads SIT data from data store to the first two RAM cards. In the example below, the SITs are loaded to DRAM number 0.

```
>SITLOAD 0
```

If you enter a PROM card in table DRAMS, do not use command SITLOAD. The PROM cards store SITs. Use only the ASSIGN command to notify the system that with regard to SITs in switches with PROM cards.

Before you use the SITLOAD command, make sure that a minimum of two RAM cards are in the maintenance trunk module (MTM) shelf. The MTM shelf relates to the DRAM used. Make sure that the required datafill for these RAM cards is in table DRAMS.

The phrase names that relate to each SIT require assignment when the SITLOAD command activates.

ASSIGN command

If the ASSIGN command is in use to assign SIT phrases and the SILENCE phrase, the following rules apply.

Switching units with PROM cards

To assign a SIT phrase name in a switching unit with PROM cards, use the command

```
>ASSIGN <dram_ no> <SIT phrase name> <length> <block>
<phrase _no>
```

In the following example, assign the SILENCE phrase

- for 1 s
- to DRAM number 0, entered in table DRAMS
- to the block number assigned to the first PROM card, entered in table DRAMS

```
>ASSIGN 0 SILENCE 1 1 0
```

Assign each separate SIT phrase. The phrase numbers, the SIT parts, and the SIT phrase names appear in the following table. The SIT phrase assignments are limited to the first PROM card only.

An example of an assignment of separate SIT phrases appears in the following table.

Example assigning individual SIT phrases

Phrase number	SIT components	SIT phrase names
8	ISISIS	SIT1
9	ISISIL	SIT2
10	ILISIS	SIT3
11	IShLIL	SIT4
12	IShSIS	SIT5
13	IShSIL	SIT6
14	IShLIS	SIT7
15	IShLIL	SIT8
16	ILISIS	SIT9
Note: I = low frequency, h = high frequency, S = short duration, L = long duration		

Example assigning individual SIT phrases

Phrase number	SIT components	SIT phrase names
17	ILISIL	SIT10
18	ILILIS	SIT11
19	ILhLIL	SIT12
20	ILhSIS	SIT13
21	ILhSIL	SIT14
22	ILhLIS	SIT15
23	ILhLIL	SIT16
24	hShSIS	SIT17
25	hShSIL	SIT18
26	hShLIS	SIT19
27	hShLIL	SIT20
28	hShSIS	SIT21
29	hShSIL	SIT22
30	hShLIS	SIT23
31	hShLIS	SIT24
32	hLISIS	SIT25
33	hLISIL	SIT26
34	hLILIS	SIT27
35	hLILIL	SIT28
36	hLhSIS	SIT29
37	hLhSIL	SIT30

Note: I = low frequency, h = high frequency, S = short duration, L = long duration

Example assigning individual SIT phrases

Phrase number	SIT components	SIT phrase names
38	hLhLIS	SIT31
39	hLhLIL	SIT32
Note: I = low frequency, h = high frequency, S = short duration, L = long duration		

The firmware can give the SIT phrase a phrase number of 8. The software can give the SIT phrase the phrase name SIT1. The preceding table indicates that these actions can occur to a SIT phrase with the following components:

- first component tone of low (l) frequency, short duration (S)
- second component tone of low (l) frequency, short duration (S)
- third component tone of low (l) frequency, short duration (S)

When you assign all SIT phrases, the datafill in table ANNPHLST changes to include the SIT and the SILENCE tones.

See the above example for SIT and SILENCE phrase assignment.

Switching units with RAM cards

Enter data in a minimum of two RAM cards and no PROM cards in table DRAMS. The SITLOAD command must be a success. Assign the SILENCE phrase to the first RAM card. Assign the first 16 SIT phrases to the first RAM card. Assign the last 16 SIT phrases to the second RAM card. The ASSIGN command has the same format as the format that appears for the PROM card in this document.

An example of how to assign SIT phrases to RAM cards appears in the following figure.

Example of datafill for table DRAMS

DRAMCARD	TMTYPE	TMNO	TMCKT	CARDCODE	CARDINFO
0 0	MTM	3 0	1X75AA		
				CTLR	DRAM0
0 1	MTM	3 2	1X75AA		
				RAM3	
0 2	MTM	3 4	1X75AA		
				RAM4	

In the figure above, the command SITLOAD loads the data for the first 16 SIT phrases into RAM card 1, block number 3. The command SITLOAD loads the second set of 16 SIT phrases in RAM card 2, block number 4.

The first phrase in the first set 16 SIT is assigned as follows:

```
>ASSIGN 0 SIT1 1 3 48
```

The first phrase from the second set of 16 SIT is assigned as follows:

```
>ASSIGN 0 SIT17 1 4 48
```

The SILENCE phrase is assigned only one time as follows:

```
>ASSIGN 0 SILENCE 1 3 0
```

When you assign all SIT phrases, enter data in these phrases in table ANNPHLST. The SIT phrases includes the SILENCE phrase.

See the "Datafill example" section for an example of datafill in table ANNPHLST.

An example of phrase numbers assigned on the first RAM card appears in the following table.

Phrase numbers on first RAM card

Phrase number	SIT components	SIT phrase names
48	ISIS	SIT1
49	ISISIL	SIT2
50	ISILIS	SIT3
51	ISILIL	SIT4
52	IShSIS	SIT5
53	IShSIL	SIT6
54	IShLIS	SIT7
55	hLILIS	SIT8
56	ILISIS	SIT9
57	ILISIL	SIT10
58	ILILIS	SIT11
59	ILILIL	SIT12
60	ILhSIS	SIT13
61	ILISIL	SIT14
62	ILhLIS	SIT15
63	ILhLIL	SIT16

Note: I = low frequency, h = high frequency, seconds = short duration, L = long duration

An example of phrase numbers assigned on the second RAM card appears in the following table.

Phrase numbers on second RAM card

Phrase number	SIT components	SIT phrase names
48	hSISIS	SIT17
49	hSISIL	SIT18
50	hSILIS	SIT19
51	hSILIL	SIT20
52	hShSIS	SIT21
53	hShSIS	SIT22
54	hShSIS	SIT23
55	hShLIL	SIT24
56	hLISIS	SIT25
57	hLISIL	SIT26
58	hLILIS	SIT27
59	hLILIL	SIT28
60	hLhSIS	SIT29
61	hLhSIL	SIT30
62	hLhLIS	SIT31
63	hLhLIS	SIT32

Note: I = low frequency, h = high frequency, S = short duration, L = long duration

Announcements

In table ANNPHLST, the SIT that comes before each standard announcements follows the guidelines that appear in the following

table. The operating company decides which SIT phrases come before the customized recorded announcements.

Standard announcements

SIT	Category	Announcements
SIT2	Customer irregularity	Automatic Intercept System (AIS), blank directory number Integrated Business Network (IBN) numbers, change and non-working stations Access code not dialed Access code dialed in error
SIT8	Equipment irregularity	Reorder
SIT2 6	Vacant code	Vacant code Unauthorized centralized automatic message accounting (CAMA)
SIT3 2	Trunk blockage	No circuit emergency

The SIT phrase names that correspond to the standard Bell Canada announcements appear in the following table.

Standard Bell Canada announcements

SIT	Category	Announcements
SIT2	BLKDN	Blank directory number
	PSPD	Permanent signal/partial dial
	NOD1	Do not dial prefix 1
	D1ER	Prefix digit 1 not dialed
	ROH	Receiver off-hook
SIT26	VCA	Vacant code
SIT32	NCA	No circuit

Table history

SN09 (DMS)

The explanations and example datafill for custom announcement types MCCS and ACTS were updated in SN09 for feature A00009013, to correct errors and to document that these applications can use either DRAM or packet announcement resources. Also, the description of AOSSVR was deleted.

The information about custom announcement type AOSSVR was removed in SN09 by feature A00009013. This application was specific to TOPS MP positions, which are no longer supported.

SN06 (DMS) and ISN06 (TDM)

Table introduced by feature A19013546. The introduction of table ANNPHLST makes tables DRMUSERS and DRAMTRK obsolete. These tables can still be accessed, but no data can be entered into them.

Mandarin and Cantonese phrases that require to be pre-recorded added by feature 89008388.

ANNS

Table name

Announcement Table

Functional description

This table contains data for each analog and digital announcement that is assigned in the switching unit.

For all line connections to announcements, the central control (CC) instructs the connecting peripheral modules (PM) to use a 0-dB (zero) pad level on the line card gain setting. This is a default value and cannot be administered. A 0-dB pad level is the nil pad group (NPDGP). For further information, refer to table PADATA.

Datafill sequence and implications

The following tables must be datafilled before table ANNS:

- CLLI
- DRAMS

The following tables must be datafilled after table ANNS:

- ANNMEMS
- ANNPHLST

Before a Subscriber Activated Call Blocking (SACB) announcement can be entered in table ANNS, an announcement CLLI must first be entered in table CLLI. An entry for SACB announcements can then be entered in table ANNS. Once value SACB is entered in table ANNS, the data for each announcement member must be entered in table ANNMEMS, and the phrases recorded on the DRAM cards must be entered in table DRMUSERS.

DMS-100 SSP standard announcements are datafilled in table ANNS and are mapped to the system announcement ID in table AINANS. DMS-100SSP customized announcements are datafilled in tables ANNS and DRMUSERS and are mapped to the system announcement ID in table AINANS.

Table size

0 to 256 tuples

Memory for table ANNS is allocated dynamically.

Note: The size of table ANNS increases if tables CUSTANN and NSCANNS and if XN26AA or X983AB are present in the office. With these

ANNS (continued)

tables, the size of table ANNS increases to 2047 tuples. This increase is needed to support a larger number of customer groups (300 to 500).

Datafill

The following table lists datafill for table ANNS.

Field descriptions

Field	Subfield or refinement	Entry	Explanation and action
CLLI		alphanumeric (1 to 16 characters)	<p><i>Announcement CLLI keys</i> Enter the code that represents the announcement in table CLLI.</p> <p>If the Attendant Busy feature is present in the switching unit, the suggested common language location identifier (CLLI) for Attendant Busy is ATTBUSY.</p> <p>If the Music On Hold feature is present in the switch, the suggested CLLI for the Music On Hold announcement is MUSIC.</p> <p>Each loudspeaker location must have its own Announcement CLLI associated with it.</p> <p>Enter fixed CLLI TOPSACTS if field ANTYPE is set to ACTS for automatic coin toll service. Office parameter TOPS_ACTS must be set to Y (yes) in table OFCENG.</p>
ANNARCH		LOCAL, NETWK, ALL	<p><i>Announcement architecture</i> Enter the announcement architecture as follows:</p> <p>LOCAL - announcement resides on each individual gateway.</p> <p>NETWK - announcement resides on a networked announcement resource</p> <p>ALL - Announcement resides on both individual gateways and a networked announcement resource.</p>

ANNS (continued)**Field descriptions**

Field	Subfield or refinement	Entry	Explanation and action
TRAFSNO		0 to127	<p data-bbox="813 464 1130 491"><i>Traffic separation numbers</i></p> <p data-bbox="813 495 1398 653">If the switch has feature package X085AA (Traffic Separation Peg Count), enter the Traffic Separation number, 1 to 127, that is assigned to the announcement. If the traffic separation is not required, enter 0 (zero).</p> <p data-bbox="813 667 1398 793">For switches with package X085AA, the range of values for the traffic separation number depends on office parameter TFAN_OUT_MAX_NUMBER in table OFCENG.</p> <p data-bbox="813 808 1398 905">For switching units without package X085AA, the range of values for the traffic separation numbers is 0 to 15.</p> <p data-bbox="813 919 1398 982">Reserve the traffic separation numbers 1 to 9 for generic traffic separation numbers.</p> <p data-bbox="813 997 1398 1031">Refer to table TFANINT for more information.</p>

ANNS (continued)

Field descriptions

Field	Subfield or refinement	Entry	Explanation and action
CYTIME		1 to 18 or 0	<p><i>Cycle times</i> Enter the time, in seconds, for one announcement cycle on one channel (see the second, third, and fourth tables in this document). An entry outside this range is invalid and will cause the recorded announcement to be cut-off, at which point the line will be placed in a SYSBSY state.</p> <p>Note 1: If the announcement cycle is longer than 18 seconds, field CYTIME can be changed to 0 (zero). This allows flexible announcement timing, which does not have a maximum limit for announcement length. The length of the announcement is always matched without datafill change.</p> <p>Note 2: If your office is equipped with a Cook or equivalent announcement machine and table AUDIO is datafilled as ANNS, 0 is datafilled in field CYTIME.</p> <p>Note 3: The cycle time for an Audichron is 0 (zero) due to the variable length announcement feature on Audichron. By setting the value of this field to 0 (zero), the length of the announcement is always matched.</p> <p>Note 4: For announcements with ANNARCH set to LOCAL, the CYTIME field is not functionally applicable; that is to say that it does not dictate the cycle time for the corresponding announcement on the local gateway. It is therefore intended to be used for informational purposes only.</p>

ANNS (continued)**Field descriptions**

Field	Subfield or refinement	Entry	Explanation and action
MAXCYC		1 to 255	<p><i>Maximum cycles</i> Enter the maximum number of times the complete announcement is heard before the call is advanced to the next route in the route list. An entry outside of this range is invalid.</p> <p>This field must be set to 1 for multilingual NTC service. For multilingual NTC service, since one tuple represents one language and one announcement cycle contains several languages, each tuple in table DRMUSERS is used only once before advancing to the next tuple (language) in the same cycle. Thus, the number of announcement cycles datafilled in table ANNS must be one to ensure that languages are repeated in the proper sequence.</p> <p>This field should be set to "1" for ADS announcements. Refer to the Audiogram Delivery Services-Offer of Service Prompt functionality (ENSV0013) in this document.</p>
DATA		see subfields	<p><i>Announcement group data</i> This field contains subfields ANNTYP, GAP, MAXCONN and ANNID.</p>

ANNS (continued)

Field descriptions

Field	Subfield or refinement	Entry	Explanation and action
	ANNTYP	<p>ACTS, AIN, AIS, AOSSVR, CFPA, CFRA, CLASS, CNAL, CNALT, CNAT, CSMI, DMCT, ECWTPA, IN, MCCS, MDS, NFRA, NTC, RCTL, SACB, SLEENG,</p> <p>SLEFRE, SPP, STND, TOPSVR or VPSA (DMS-250 only)</p>	<p><i>Announcement type</i> This field is only prompted for when field ANNARCH is set to ALL or NETWK.</p> <p>Enter the announcement type as follows:</p> <ul style="list-style-type: none"> • ACTS to specify Automatic Coin Toll Service • AIN to specify a given DMS user interface for each customer group • AIS to specify Automatic Intercept System announcement if the switch has the AIS feature • AOSSVR to specify AOSS Voice Response • CFPA to specify Call Forwarding Programming announcement • CFRA to specify Call Forwarding Remote Access announcement • CLASS to specify Custom Local Area Signaling Services announcement • CNAL to specify Calling Number Announcement playback to a line • CNAT to specify Calling Number Announcement playback over a trunk to a loudspeaker • CSMI to specify Call Screening, Monitoring, and Intercept • DMCT to specify Denied Malicious Call Termination

ANNS (continued)**Field descriptions**

Field	Subfield or refinement	Entry	Explanation and action
			<ul style="list-style-type: none"> • ECWTPA to specify Enhanced Call Waiting Programming announcements • IN to specify an Intelligent Network (IN) Capability Set 1 Revised (CS-1R) custom announcement. • MCCS to specify Mechanized Calling Card Announcement • MDS to specify Audiogram Delivery Services (ADS) announcements. Refer to the Audiogram Delivery Services-offer of Service Prompt functionality (ENSV0013) in this document. • NFRA to specify Network facility Remote Access • NTC to specify Notification of Time and Charge announcement • RCTL to specify Subscriber Programmable Ringing for CFDVT (SPRING) • SLEENG to specify Screening List Editing English • SLEFRE to specify Screening List Editing French • SPP to specify Station Programmable PIN (Personal Identification Number) • STND to specify Standard Announcement • SACB to specify Subscriber Activated Call Blocking • TOPSVR to specify TOPS Voice Response <p>Office parameter TOPS_ACTS must be set to Y in table OFCENG</p> <ul style="list-style-type: none"> • VPSA to indicate Variable Phrase Standard Announcement (VPSA) phrases such as DNAENG (dialed number digits), CHAENG (charged number digits), CGAENG (calling number digits) or CNAENG (called number digits). For DMS-250 only.

ANNS (continued)**Field descriptions**

Field	Subfield or refinement	Entry	Explanation and action
	GAP	Y, N	<i>GAP</i> Enter the value Y to generate a gap between the tracks of a multi-track announcements. Enter N to have no gap between the track of a multi-track announcements. The system produces the GAP prompt only for selected announcement types.
	MAXCONN	1 to 255	<i>Maximum connections</i> This field is only prompted for when field ANNARCH is set to ALL or NETWK. Enter the maximum number of simultaneous connections that are permitted on the announcement. An entry outside this range is invalid. If ANNTYPE is equal to VPSA or CNAT, a value of 255 must be entered. For XA-Core, Nortel Networks recommends 255 be entered.
	ANNID	1 to 10 Character String, valid chars are {A..Z, 0..9, _}	<i>Announcement identifier</i> This field is only prompted for when field ANNARCH is set to ALL or LOCAL. Enter the H.248 announcement ID communicated from the DMS-MSC/Server to the MGW.

The following table shows the times for one cycle of prerecorded announcement. Use this table to datafill field CYTIME.

If special information tone (SIT) or silence is the first phrase for the announcement in the DRAMTRK table, add 1 s to the values shown.

ANNS (continued)

The time shown has been rounded off to the next second. The value in brackets is the actual value.

One-cycle prerecorded announcement time

Announcement	Time (in seconds)
No circuit (NCA)	10 (9.248)
Sender overload (SOA)	10 (9.248)
Reorder (ROA)	9 (8.96)
Vacant code (VCA)	12 (12.032)
Unauthorized code (UCA)	12 (12.032)
Receiver off-hook (ROH)	13 (12.544)
Vacant disconnect	7 (6.208)
Misdirected centralized	11 (10.592)
Automatic message accounting (AMA) toll access code not dialed	10 (10.016)

The following table shows cycle times for digits.

One-cycle digit time

Digit	Duration
0	1 (.608)
1	1 (.512)
2	1 (.544)
3	1 (.544)
4	1 (.640)
5	1 (.768)
6	1 (.640)
7	1 (.672)
8	1 (.544)
9	1 (.672)

ANNS (continued)

The following table shows cycle times for special symbols.

One-cycle special symbol time

Special symbol	Duration
Silence	1 (1.024)
Test tone	1 (.160)
Prompt	1 (.992)

Datafill example

The following examples show sample datafill for table ANNS.

ANNS (continued)**MAP display example for table ANNS**

CLLI	ANNARCH	TRAFSNO	CYTIME	MAXCYC	DATA
CNALINE	NETWK	0	1	4	CNAL Y 1
PSPD	NETWK	26	2	10	STND Y 30
TDND	NETWK	25	2	10	STND Y 30
CKTBSY	NETWK	25	2	10	STND Y 30
MLA	NETWK	25	2	10	STND Y 30
MCA	NETWK	25	2	10	STND Y 30
OHQANNC	NETWK	25	2	10	STND Y 30
VDN	NETWK	25	2	10	STND Y 30
VCA	NETWK	25	2	10	STND Y 30
EA4	NETWK	25	2	10	STND Y 30
EA3	NETWK	25	2	10	STND Y 30
WND	NETWK	0	2	15	STND Y 90
VACT	NETWK	0	2	15	STND Y 90
BLDN	NETWK	0	2	15	STND Y 90
CLASSANN	NETWK	30	0	1	CLASS 1
TDND	NETWK	25	2	0	CFRA 0
ARCONF	NETWK	0	2	16	STND Y 90
ACBBUSY	NETWK	0	2	16	STND Y 90
ARBUSY	NETWK	0	2	16	STND Y 90
ACBSTD	NETWK	0	2	16	STND Y 90
ARSTD	NETWK	0	2	16	STND Y 90
ACBLTD	NETWK	0	2	16	STND Y 90
ARLTD	NETWK	0	2	16	STND Y 90
ACBDEACT	NETWK	0	2	16	STND Y 90
ARDEACT	NETWK	0	2	16	STND Y 90
ARDN	NETWK	0	2	16	STND Y 90
ARPRIV	NETWK	0	2	16	STND Y 90
ACBCONF	NETWK	0	2	16	STND Y 90
CONF COT	NETWK	0	2	16	STND Y 90
FAILCOT	NETWK	0	2	16	STND Y 90
PRMT1COT	NETWK	0	2	16	STND Y 90
PRMTNCOT	NETWK	0	2	16	STND Y 90
SLEENG1	NETWK	25	1	0	SLEENG 1
SLEENG2	NETWK	25	1	0	SLEENG 1
ADBFANN	NETWK	30	3	0	STND Y 30
PVNCOLA	NETWK	0	2	4	STND Y 1
PVNCOLB	NETWK	0	2	3	STND Y 1
PVNCOLC	NETWK	0	2	9	STND Y 1
PVNCOLD	NETWK	0	2	2	STND Y 1

ANNS (continued)**MAP display example for table ANNS**

CLLI	ANNARCH	TRAFSNO	CYTIME	MAXCYC	DATA
ALL_RANN	ALL	0	7	1	STND Y 255 ALLID
NETWK_RANN	NETWK	0	7	1	STND Y 255
LOCAL_RANN	LOCAL	0	7	1	LOCALID

Table history**ISN07 (DMS)****Q00876144**

Added ANNARCH and ANNID fields that were previously not added under GSM activity A89009169 for SN06. These fields accommodate GSM MGW announcements, where the announcements reside and are provided by the individual MGW's themselves.

NA017

DMS-100 SSP standard and customized announcements are datafilled in table ANNS as a result of feature 59037140.

MMP13

Added ANNTYPE Variable Phrase Standard Announcement (VPSA) for DMS-250 only. Changed MAXCONN entry to 255 for ANNTYPE = VPSA or CNAT for XA-Core.

NA010

Feature AJ5131 adds subfield GAP to selected announcement types in field ANTYPE. This supports gapping of multi-track announcements.

APC010

Added announcement types CFPA, ECWTPA, and RCTL for the Enhanced Call Waiting feature.

GL03

Added announcement type IN to field ANTYPE for an Intelligent Network (IN) Capability Set 1 Revised (CS-1R) custom announcement.

APC06

Added information associated with multilingual NTC service.

NA005

Added announcement type RCTL to field ANTYPE for the SPRING feature.

ANNS (continued)

Changed entry for field CYTIME for flexible announcement time.

Feature AN1542 in the functionality Audiogram Delivery Services-Offer of Service Prompt functionality (ENSV0013) introduces the ANTYPE “MDS” for ADS announcements and specific datafill requirements for the MAXCYC field.

Added announcement type CSMI to field ANNTYPE for Call Screening, Monitoring and Intercept.

APC04

Value NTC was added to field ANTYPE.

BCS36

A clarification of line connections to announcements was added. Value DMCT was added to field ANTYPE.

APCDINV

Table name

Application Processor Card Inventory Table

Functional description

Table APCDINV contains the descriptions of the following:

- the resource processor (RP) cards
- the cards of the application processors (APs)
- all cards that a file processor (FP) contains except the cards that mass storage devices contain
- the power converters on the AP/FP shelf

Related table APINV contains the configuration data the RP MAP facility and the Integrated Node Maintenance (INM) software requires. The tuples you enter in table APINV causes the system to add default tuples to table APCDINV. The tuples you add in table APINV for an AP causes the system to add the following tuples to table APCDINV:

- One tuple for each of the two slots that contain power converters.
- One tuple for each of two specified slots. These two slots contain a central processing unit (CPU) card in the front and a reset terminal interface (RTIF) paddleboard in the back.
- One tuple for each of two specified slots. These slots contain a port card in the front and a port card in the back.
- One tuple for each of the two slots that contain the required memory cards
- One tuple for each of the two slots that contain bus terminators

When you add a new AP tuple to table APINV, the system automatically adds ten tuples in total to table APCDINV. When you delete the main tuple for the AP from table APINV, the system deletes all tuples for an AP.

The tuples you enter in table APINV for an FP causes the system to add the following tuples to table APCDINV:

- One tuple for each of the two slots that contain power converters.
- One tuple for each of two specified slots. These slots contain a CPU card in the front and an RTIF paddleboard in the back.
- One tuple for each of the two slots. These two slots contain a port card in the front and a port card in the back.
- One tuple for each of the two slots that contain the required memory cards.

APCDINV (continued)

- One tuple for each of the two slots that contain bus terminators.
- One tuple for each of two specified slots. These slots contain a dual-access buffer memory card in the front. These slots contain a small computer interface (SCSI) paddleboard in the back.

When you add a new FP tuple to table APINV, the system automatically adds 12 tuples in total to table APCDINV. When you delete the main tuple for the FP from table APIN, the system deletes all tuples for an FP.

Datafill sequence and meaning

Enter data in the following tables before you enter data in table APCDINV:

- MSCDINV
- PMLOADS
- APINV

Table size

Memory for table APCDINV has a dynamic definition. The maximum size of table APCDINV is 2800 tuples. The number of nodes in table APINV determines the required data store. This condition occurs because the system automatically adds most of the data in table APCDINV. The system adds the data when you enter data in table APINV. Each AP requires 250 words of data store. Each FP requires 250 words of data store with an additional 150 words. The additional 150 words are for the addition of cards not on the same shelf or quadrant as the FP is.

Datafill

The data entries for table APCDINV appear in the following table.

Field descriptions (Sheet 1 of 3)

Field	Subfield or refinement	Entry	Explanation and action
SMNTYPE		AP or FP	<i>Sync-matched node type.</i> Enter AP to indicate an application processor. Enter FP to indicate a file processor. This key is the first of a four-part key.
SMNNO		0 to 99	<i>Sync-matched node instance number.</i> Enter the instance number of the resource processor. This key is the second of a four-part key.

APCDINV (continued)

Field descriptions (Sheet 2 of 3)

Field	Subfield or refinement	Entry	Explanation and action
SHELF		0 to 3	<i>Shelf number.</i> Enter the shelf number that contains the RP. The shelves begin with the number zero (0) at the bottom and are numbered from bottom to top. This key is the third of a four-part key.
SLOT		1 to 38	<i>System slot.</i> Enter the Northern Telecom (Nortel) slot number. This key is the fourth of a four-part key.
FRONTCRD		CPU MEMORY PORT POWER or NIL	<i>Front card element class.</i> Enter the element group of the card in the front side of the card slot.
FRONTPEC		NTDX15AA, NT9X13LA, NT9X14DA, NT9X14DB, NT9X86AA, NT9X87AA, NT9X91AA or NIL	<p><i>Front card product engineering code.</i> Enter the product engineering code (PEC) for the card entered in field FRONTCRD.</p> <p>If the entry in field FRONTCRD is CPU, enter NT9X13LA.</p> <p>If the entry in field FRONTCRD is MEMORY, enter NT9X14DA, NT9X14DB or NT9X87AA.</p> <p>If the entry in field FRONTCRD is PORT, enter NT9X86AA.</p> <p>If the entry in field FRONTCRD is POWER, enter NT9X91AA or NTDX15AA. Any entry that is not NT9X91AA or NTDX15AA is not correct.</p> <p>If the entry in field FRONTCRD is NIL, enter NIL. The card slot is empty or has a filler card.</p>

APCDINV (end)**Field descriptions (Sheet 3 of 3)**

Field	Subfield or refinement	Entry	Explanation and action
BACKCRD		BEXT, PORT, TERM, TIF or NIL	<i>Back card element class.</i> If the entry in field FRONTPEC is NIL, enter this refinement. Enter the element group of the card that is on the back side of the card slot.
BACKPEC		NT9X21AB, NT9X26AA, NT9X26AB, NT9X26CA, NT9X62AA, NT9X88AA, NT9X89AA or NIL	<i>Back card PEC.</i> If the entry in field FRONTPEC is NIL, enter data in this subfield. If the entry in subfield BACKCRD is BEXT, enter NT9X89AA. If the entry in subfield BACKCRD is PORT, enter NT9X62AA or NT9X88AA. If the entry in subfield BACKCRD is TERM, enter NT9X21AB. If the entry in subfield BACKCRD is TIF, enter NT9X26AA, NT9X26AB or NT9X26CA. If the entry in subfield BACKCRD is NIL, enter NIL. The card slot is empty or has a filler card.

Datafill example

Sample datafill for table APCDINV appears in the following example.

MAP example for table APCDINV

SMNTYPE	SMNNO	SHELF	SLOT	FRONTCRD	FRONTPEC
BACKCRD		BACKPEC			
AP	0	1	13	CPU	NT9X13LA
TIF	NT9X26CA				

Table history
BCS33

Table APCDINV was introduced in BCS33.

APINV

Table name

Application Processor Inventory Table

Functional description

Table APINV contains information about file processors (FPs) and application processors (APs) on a DMS SuperNode switch. Table APINV contains the following:

- the type and instance of a processor
- the location of the processor
- the link and software configuration data. The resource processor (RP) MAP facility and the Integrated Node Maintenance (INM) software require this data.

The standard table editor provides user interface to access the data in table APINV.

The other tables do not transmit data to table APINV. Tables APCDINV, FPDIPINV, FPDEVINV and PMLOADS are related to table APINV.

Datfill sequence and meaning

Enter data in the following tables before you enter data in table APINV:

- MSCDINV
- PMLOADS
- APINV

The entry in field LOADNAME of table APINV must match the entry in field LOADNAME of table PMLOADS.

Table size

Memory for table APINV has a dynamic definition. The maximum size of table APINV is 200 tuples. The number of nodes in table APINV determines the data store required. This condition occurs because the system automatically adds most data in table APCDINV. The system adds the data when you enter data in table APINV. Each AP requires 250 words of data store. Each FP requires 250 words of data store and an additional 150 words. The additional 150 words are for the addition of cards not on the same shelf or quadrant as the FP.

APINV (continued)**Datafill**

Datafill for table APINV appear in the following table.

Field descriptions (Sheet 1 of 2)

Field	Subfield or refinement	Entry	Explanation and action
SMNTYPE		AP or FP	<i>Sync-matched node type.</i> Enter AP to indicate an application processor. Enter FP to indicate a file processor. This key is the first of a two-part key.
SMNNO		0 to 99	<i>Sync-matched node instance number.</i> Enter the instance number of the resource processor (RP). This key is the second of a two-part key.
FUNCTION		alphanumeric (vector of a maximum of 12 characters)	<i>Sync-matched node function.</i> Enter a string of characters to identify the function of the RP at the standard table editor level on the MAP display.
LOADNAME		alphanumeric (vector of a maximum of 8 characters)	<i>Default loadfile name.</i> Enter the name of the file that system-initiated reload recovery operations loaded into the RP. This name is the default loadfile name when a technician issues the LOADPDM command. The technician issues the command at the PM level of a MAP terminal. This file must be in table PMLOADS. This file must be on a permanent device and not a tape device.
SELFLOAD		Y or N	<i>Self-loading capability.</i> Enter Y to indicate the RP has self-loading ability when the system initiates a system recovery action. The RP has this ability when operating company personnel issue the LOADPDM command at the PM level of the MAP terminal.
FLOOR		0 to 99	<i>Floor position.</i> Enter the floor number of the cabinet that contains the RP.
ROW		A to Z or AA to ZZ (except I, O, II and OO)	<i>Row position.</i> Enter the row position of the cabinet that contains the RP.
FRAME		0 to 99	<i>Frame position.</i> Enter the frame position in the RP row.

APINV (continued)

Field descriptions (Sheet 2 of 2)

Field	Subfield or refinement	Entry	Explanation and action
SHELF		0 to 3	<i>Shelf number.</i> Enter the shelf number that contains the RP. Shelves are numbered from bottom to top. The numbers begin at 0.
SHELFPEC		NT9X81AA	<i>Shelf product engineering code.</i> Enter the product engineering code (PEC) of the shelf that contains the RP.
QUADRANT		0 to 3	<i>Quadrant range.</i> Enter the quadrant range of the RP. An RP can be in quadrant ranges 0 to 1 or 2 to 3. Enter 0 or 1 for the first quadrant range. Enter 2 or 3 for the second quadrant range.
LINKRATE		R128 or R256	<i>Link rate.</i> Enter the bandwidth on the fiber that connects the RP to the DMS-bus. The bandwidth is the number of channels.
LINKS		see subfields	<i>SMN port configuration.</i> This field is a vector that contains one or more entries of subfields TCARDNO, TLINKNO, DNODENO, DCARDNO and DLINKNO. Each subfield describes the location of one link on the node. Each subfield also describes the place that the link connects to the DMS-bus. Terminate the vector with a \$.
	TCARDNO	1 to 38	<i>Terminating card number.</i> Enter the card number of the terminating link on the node.
	TLINKNO	0 to 1	<i>Terminating link number.</i> Enter the link number of the terminating link on the node, with regard to the card on which the link terminates. The card is an entry in subfield TCARDNO.
	DNODENO	0 to 1	<i>DMS-bus node number.</i> Enter the DMS message switch (MS) node number to which the link connects.
	DCARDNO	1 to 26	<i>DMS-bus card number.</i> Enter the card number of the destination link on the MS.
	DLINKNO	0 to 7	<i>DMS-bus link number.</i> Enter the link number of the destination link on the card.

Datafill example

Sample datafill for table APINV appears in the following example.

MAP example for table APINV

SMNTYPE	SMNNO	FUNCTION	LOADNAME	SELFLOAD	FLOOR
ROW	FRAME	SHELF			
SHELFPEC	QUADRANT	LINKRATE			
	LINKS				
<hr/>					
AP	0	LTS	LTS28IS	N	3
R	7	1			
NT9X81AA	0	R256			
(12 0 0 15 0)	(15 0 1 15 0)	(12 1 1 16 0)	(15 1 0 16 0)		
\$					

Table history**BCS36**

The range of values for field LINKRATE is now correct. Values R64 and DS512 are deleted in BCS36.

BCS33

Table APINV was introduced in BCS33.

AREACODE

Table name

Service Switching Point Area Code Table

Functional description

Table AREACODE is used to store area codes in the service area of a service switching point (SSP).

The area codes listed are the area codes of subscriber lines serviced by the SSP. These subscriber lines include lines on other SSPs when the subscriber accesses the virtual private network (VPN) through the serving SSP.

Datafill sequence and implications

There is no requirement to datafill other tables prior to table AREACODE.

Table size

0 to 32 767 tuples

Datafill

The following table lists datafill for table AREACODE.

Field descriptions

Field	Subfield or refinement	Entry	Explanation and action
AREACODE		numeric (1 to 18 digits)	<i>Area code</i> Enter the area code number.
LENGTH		1 to 18	<i>Area code digit length</i> Enter the number of digits used in field AREACODE for the area code number entered. Note: 0 (zero) is not a valid entry for this field.

Datafill example

The following example shows sample datafill for table AREACODE.

AREACODE (end)

MAP display example for table AREACODE

AREACODE	LENGTH
519	3
967967	6
1239996668881212	16

ARUIBMRT

Table name

Audio Response Unit IBM Route

Functional description

Table ARUIBMRT is used to convert a destination identification (ID) supplied by the Directory Assistance System (DAS) vendor to an office route of the external audio response unit (ARU). Table ARUIBMRT is indexed by the destination ID that is sent by the DAS in an immediate transfer, transfer, or referral message. The table represents a group of announcements based on the language identified by the destination ID. The office route obtained from table ARUIBMRT serves as an index into table OFRT.

Table ARUIBMRT is part of feature AF1266 (IBM DA Protocol and Simulator) that is used in conjunction with the TOPSMPVR FOLDBACK features to provide for Traffic Operator Position System (TOPS) to service DA and intercept (INT) call types while utilizing an Integrated Business Network (IBM)-DAS vendor.

In addition to table ARUIBMRT, feature AF1266 uses table OPRCMPLX. Tables SERVICES, TOPSPOS, OPRDAT, and MPCFASTA are also impacted as a result of allowing intercept service to be datafilled.

Datafill sequence and implications

Table OFRT must be datafilled before table ARUIBMRT.

Table size

0 to 15 tuples

ARUIBMRT (end)**Datafill**

The following table lists datafill for table ARUIBMRT.

Field descriptions

Field	Subfield or refinement	Entry	Explanation and action
DESTID		1 to 15	Destination identification. Enter the destination identification (ID). This represents a group of audio response units (ARU) that is chosen by the Directory Assistance System (DAS). Parallel datafill is needed in the DAS to properly match ARU destinations between the DAS and the DMS.
OFRTIDX		0 to 1023	Office route index. Enter the route index mapped against the destination ID. This route index is the index into table OFRT that contains a route list.

Datafill example

The following example shows sample datafill for table ARUIBMRT.

MAP display example for table ARUIBMRT

DESTID	OFRTIDX
1	200
2	201

Table history**BCS36**

Table OFRT was added to the datafill sequence.

ARUMEMBR

Table name

Audio Response Unit Member Table

Functional description

Table ARUMEMBR is used to associate a Traffic Operator Position System audio response unit (TOPSARU) trunk member with a Directory Assistance System (DAS) trunk identification (ID). This trunk ID is used by the DAS to determine which circuit has been seized by the DMS.

For related information, refer to table ARURTE.

Datafill sequence and implications

The following tables must be datafilled before table ARUMEMBR.

- TRKGRP
- TRKMEM

Table size

0 to 32 000 tuples

Data store is allocated dynamically. Sufficient data store is allocated for all common language location identifier (CLLI) members as prescribed in table CLLI (one word for each member). If there is datafill in table ARUMEMBR for a CLLI and the CLLI size is changed in table CLLI, then all members for the CLLI in table ARUMEMBR must be deleted and added again so the correct amount of data store can be allocated. The equation for doing this is: $48 + n$ (where n is the total number of members in each CLLI group).

Datafill

The following table lists datafill for table ARUMEMBR.

Field descriptions (Sheet 1 of 2)

Field	Subfield or refinement	Entry	Explanation and action
ARUMEM		see subfields	Audio response unit member. This field consists of subfields CLLI and MEM.
	CLLI	alphanumeric (1 to 16 characters)	Common language location identifier. Enter the code assigned to the trunk group member in table CLLI. From 1 to 101 trunk groups can be assigned.

ARUMEMBR (continued)**Field descriptions (Sheet 2 of 2)**

Field	Subfield or refinement	Entry	Explanation and action
	MEM	numeric (0 to 9999)	Member name. Enter the identification number of the member.
DASTRKID		numeric (0 to 9999)	Directory Assistance System trunk identification digit. Enter the number that the Directory Assistance System (DAS) uses to identify this trunk group member.

Datafill example

The following example shows sample datafill for table ARUMEMBR.

MAP display example for table ARUMEMBR

ARUMEM	DASTRKID
DAARU1 0	30
DAARU1 1	100
DAARU1 2	101
DAARU1 2	102
DAARU2 0	103

Supplementary information

This section provides additional information related to table ARUMEMBR

Limitations

In table TRKSGRP, a TOPSARU trunk must have a direction of outgoing and the outpulsing type must be NP (no pulse). If an attempt is made to enter data other than this, then one of the following error messages is produced:

SUBGROUP AND GROUP DIRECTIONS DO NOT MATCH

or

TOPSARU TRUNKS MUST BE NO PULSE

There is a relationship between tables TRKGRP and ARUMEMBR. Members cannot be datafilled in table ARUMEMBR without being datafilled in table

ARUMEMBR (continued)

TRKGRP first. If an attempt is made to datafill table ARUMEMBR first, the following error message is produced:

```
NOT A VALID CLLI
```

Conversely, a group cannot be removed from table TRKGRP without all its members being deleted from table ARUMEMBR first. If an attempt is made to delete a group with members remaining in table ARUMEMBR, the following error message is produced:

```
MEMBERS EXIST IN ARUMEMBR
```

There is a relationship between tables TRKMEM and ARUMEMBR. Members cannot be datafilled in table ARUMEMBR without being datafilled in table TRKMEM first. If an attempt is made to datafill table ARUMEMBR first, the following error message is produced:

```
NOT A VALID TOPSARU MEMBER
```

Changes are not allowed in table TRKGRP if there is data in table ARUMEMBR for that CLLI. If an attempt is made to change the data in table TRKGRP, the following error message is produced:

```
DELETE MEMBERS OF THIS GROUP FROM ARUMEMBR FIRST
```

Table ARUMEMBR can hold up to 16 different CLLIs. If an attempt is made to add more than 16 different CLLIs, the following error message is produced:

```
MAX NUMBER OF GROUPS IN TABLE EXCEEDED
```

Also in table ARUMEMBR, CLLIs other than TOPSARU CLLIs are not allowed to be entered. If a CLLI other than a TOPSARU CLLI is attempted, the following error message is produced:

```
CLLI MUST BE A TOPSARU TRUNK
```

Another limitation of table ARUMEMBR is the DASTRKID. The same DASTRKID cannot be datafilled against two different CLLI members. If an attempt is made to datafill the DASTRKID twice, the following error message is produced:

```
DASTRKID IS ALREADY DATAFILLED
```

Trunk members datafilled in table TRKMEM cannot be deleted from table TRKMEM if they remain datafilled in table ARUMEMBR. If an attempt is

ARUMEMBR (end)

made to delete a such trunk member from table TRKMEM, the following error message is produced:

```
DELETE TRUNK MEMBER FROM TABLE ARUMEMBR BEFORE DELETING FROM  
TABLE TRKMEM
```

If all the members are deleted from a CLLI group in table ARUMEMBR, the following warning is produced:

```
WARNING: DELETION OF THE LAST MEMBER IN A CLLI GROUP COULD  
EFFECT TOPS DA EXTERNAL ARU'S
```

However, the deletion is not blocked.

Member numbers are datafilled according to the same rules as in table TRKMEM.

Table history

TOPS03

Added number of trunk groups that can be assigned in field CLLI per AN0880 in DA Automation I/F, OSDA0006.

ARURTE

Table name

Audio Response Unit Route Table

Overview

This section introduces three new tables that provide for the seizure of circuits and the routing of announcements by the DMS and Directory Assistance System (DAS).

The following tables are used:

- Table ARURTE is indexed by a pool identification (ID) that is sent from the DAS in an audio response unit (ARU) request message. It represents a pool of announcement-specific ARUs. The data associated with the pool ID is an index into table OFRT. This index points to a route list.
- Table ARUMEMBR is used to associate a TOPSARU trunk member with a DAS trunk ID. This trunk ID is used to tell the DAS which circuit has been seized by the DMS.
- Table XANNINFO is based upon an announcement number. After an announcement over an external ARU has ended, the system checks the table to see if the call can be connected or reconnected to an operator.

Functional description

Table ARURTE is created to associate a pool ID with a route list. The route list is obtained through table OFRT. Table ARURTE is indexed by pool ID and contains an index into table OFRT. This allows flexibility in assigning the ARU (internal, external) because the common language location identifier (CLLI) representing the external ARU or the CLLI representing the internal ARU can be datafilled into the route list.

Datafill sequence and implications

Table OFRT must be datafilled before table ARURTE.

Table size

0 to 16 tuples

Table ARURTE is a static table and requires 16 words of data store for each tuple.

ARURTE (end)

Datafill

The following table lists datafill for table ARURTE.

Field descriptions

Field	Subfield or refinement	Entry	Explanation and action
POOLID		0 to 100	Pool identification digit. Enter a group of audio response units (ARU) that are chosen by the Directory Assistance System (DAS).
OFRTIDX		0 to 1023	Office route table index. Enter the index into table OFRT. This value is used to datafill a route list.

Datafill example

The following example shows sample datafill for table ARURTE.

MAP display example for table ARURTE

```
POOLID OFRTIDX
-----
0      207
```

Table history

TOPS03

The range of field POOLID is increased to 0-100 per feature AN0880 in DA Automation I/F, OSDA0006.

ASCS

Table name

Alarm Sending and Checking Table

Functional description

Table ASCS is used in local or combined local and toll switching units that are required to convey alarm indications to a remote point whenever the switching unit is unattended.

Alarm sending to a remote point over a trunk can be enabled or canceled by the momentary operation of the non-locking alarm transfer switch at the alarm control and display panel.

When alarm sending is enabled, any alarm in the switching unit results in a trunk seizure. Upon answer, a tone is sent over the trunk to inform the operator of the alarm. The tone continues to be sent until either the alarm condition clears, the alarm checking directory number (DN) is dialed, or the trunk times out. In the latter case, the sending function is repeated after a specified period of time if the alarm condition is not corrected. In situations where all trunks are busy, the alarm call is queued and served when an idle trunk becomes available.

When the alarm-checking DN is dialed, the tone assigned to the highest class of alarm with an alarm condition is sent to the originating operator who dialed the alarm-checking DN.

The following office parameters are associated with the Alarm Sending and Checking feature. See table OFCVAR for information about these office parameters:

- ASCS_DISABLE_LEVEL
- ASCS_MONITOR_DELAY
- ASCS_NOALARM_THRESHOLD
- ASCS_NOSEND_THRESHOLD
- ASCS_ROUTE_INDEX
- ASCS_TRUNK_TIMEOUT

The pseudo fixed common language locator identifier (CLLI) code ASCS is also associated with the Alarm Sending and Checking feature. See table CLLI for information about the CLLI code ASCS.

ASCS (continued)**Datafill sequence and implications**

There is no requirement to datafill other tables prior to table ASCS.

Table size

0 to 6 tuples

Datafill

The following table lists datafill for table ASCS.

Field descriptions

Field	Subfield or refinement	Entry	Explanation and action
ALARM		CR, FP, MJ, MN, NA, or SD	<p><i>Alarm</i></p> <p>Enter the alarm type for which a tone must be sent to the operator when the alarm condition occurs. Valid entries are described below:</p> <ul style="list-style-type: none"> • CR (critical alarm) • FP (fuse or power alarm) • MJ (major alarm) • MN (minor alarm) • NA (no alarm) • SD (send alarm)
TONE		see subfield	<p><i>Tone</i></p> <p>This field consists of subfield CLLI.</p>
	CLLI	alphanumeric (1 to 16 characters)	<p><i>Common language location identifier</i></p> <p>Enter the common language location identifier (CLLI) of the tone assigned to the alarm. The CLLI of the tone must exist as an entry in table TONES.</p> <p>If the entry in field ALARM is SD, this entry indicates which tone to use for the alarm sending class that remotely signals an alarm.</p> <p>If the entry in field ALARM is other than SD, this entry indicates which tone to use in checking calls to indicate the level of alarm.</p>

ASCS (end)

Datavill example

The following example shows sample datavill for table ASCS.

MAP display example for table ASCS

ALARM	TONE
NA	*OFLO
MN	*TST1
MJ	*TST2
FP	TSECDT
CR	*TST3
SD	*FRA0

ASRTABLE

Table name

Automatic Set Relocation Table

Functional description

Table ASRTABLE contains old and temporary line equipment numbers (LEN), personal identification codes, and primary directory numbers (PDN) of sets in transit.

This table is internally datafilled when feature Automatic Set Relocation (ASR) is implemented. Read-only data is provided in case of problems during an ASR.

Datafill sequence and implications

Table LNINV must be datafilled before table ASRTABLE.

Table size

0 to 160 tuples

Datafill

The following table lists datafill for table ASRTABLE.

Field descriptions (Sheet 1 of 3)

Field	Subfield or refinement	Entry	Explanation and action
KEY		numeric (0 to 1022)	<i>Key</i> Enter the key for this table.
ID		numeric (6 digits)	<i>Personal identification code</i> Enter the personal identification code.
PDN		numeric (7 digits)	<i>Primary directory number</i> Enter the primary directory number (PDN).

ASRTABLE (continued)

Field descriptions (Sheet 2 of 3)

Field	Subfield or refinement	Entry	Explanation and action
OLDLEN		see subfields	<p><i>Old line equipment number</i> Enter the line equipment number (LEN) of the set being relocated.</p> <p>This field defines the physical location of the equipment that is connected to a specific telephone line.</p> <p>Because field LEN is common to more than 60 tables, it is documented in a single section to avoid unnecessary duplication. Refer to section "Common entry field LEN" for a complete description of field LEN and associated subfields.</p> <p>Field LEN consists of subfields SITE, FRAME, UNIT, DRAWER or LSG, SHELF, SLOT, and CIRCUIT.</p>
TEMPLN		see subfields	<p><i>Temporary line equipment number</i> Enter the temporary LEN of the set being relocated.</p> <p>This field defines the physical location of the equipment that is connected to a specific telephone line.</p> <p>Because field LEN is common to more than 60 tables, it is documented in a single section to avoid unnecessary duplication. Refer to section "Common entry field LEN" for a complete description of field LEN and associated subfields.</p> <p>Field LEN consists of subfields SITE, FRAME, UNIT, DRAWER or LSG, SHELF, SLOT, and CIRCUIT.</p>
MATE		see subfields	<p><i>Mate</i> This field consists of subfields MATEBOOL and MATETEMP.</p>

ASRTABLE (continued)

Field descriptions (Sheet 3 of 3)

Field	Subfield or refinement	Entry	Explanation and action
	MATEBOOL	Y or N	<i>Matebool</i> Enter Y (yes) if a MATE is used, and datafill refinement MATETEMP. Otherwise, enter N (no).
	MATETEMP	see subfields	<i>Mate temporary line equipment number</i> Enter the mate temporary LEN of the set being relocated. This field defines the physical location of the equipment that is connected to a specific telephone line. Because field LEN is common to more than 60 tables, it is documented in a single section to avoid unnecessary duplication. Refer to section "Common entry field LEN" for a complete description of field LEN and associated subfields. Field LEN consists of subfields SITE, FRAME, UNIT, DRAWER or LSG, SHELF, SLOT, and CIRCUIT.

Datafill example

The following example shows sample datafill for table ASRTABLE.

In the example, ID 123456, having a PDN of 7225000 and an existing LEN of 00 0 01 01 is being assigned a temporary LEN of 00 2 10 10, MATE is not assigned.

MAP display example for table ASRTABLE

KEY	ID	PDN	OLDLEN	TEMPLN	MATE
101	123456	7225000	HOST 00 0 01 01	HOST 00 2 10 10	N

ASRTABLE (end)

Table history

BCS36

The LEN datafill information was corrected.

ASSVFEAT**Table name**

Assisted Service Features Table

Functional description

This table manages read and write access to DMS features on a per-feature basis by an intelligent peripheral (IP) module over the network facility access (NFA) X.25 data links. The table also manages what data is sent over the NFA X.25 data link to the IP as part of the call context message.

Datafill sequence and implications

There is no requirement to datafill other tables prior to table ASSVFEAT.

Table size

The maximum size is 1024 entries.

Datafill

The following table lists datafill for table ASSVFEAT.

Field descriptions for table ASSVFEAT (Sheet 1 of 2)

Field	Subfield or refinement	Entry	Explanation and action
ASSVKEY		alphanumeric	<i>Assisted Service key</i> Enter a valid line option (for example, 3WC or CFW).
CONTEXT		Y or N	<i>Context</i> Enter Y (yes) if the feature information will be sent on call context.

ASSVFEAT (end)

Field descriptions for table ASSVFEAT (Sheet 2 of 2)

Field	Subfield or refinement	Entry	Explanation and action
QUERY		Y or N	<i>Query</i> Enter Y (yes) if the IP will be able to query the feature.
PROGRAM		Y or N	Program. Enter Y (yes) if the IP will be able to program the line option. Currently only the following CFW line options are programmable by the IP: <ul style="list-style-type: none"> • For RES lines: CFBL, CFDA, CFW, and SCF • For IBN lines: CBE, CBI, CBU, CDE, CDI, CDU, CFB, CFD, CFF, CFI, and CFU

Datafill example

The following example shows sample datafill for table ASSVFEAT.

MAP display example for table ASSVFEAT

ASSVKEY	CONTEXT	QUERY	PROGRAM
CFW	Y	Y	Y
3WC	Y	Y	N
CFDA	Y	Y	Y
MWT	Y	Y	N
SCF	N	Y	Y

Table history

NA004

IBN line considerations added to field PROGRAM.

NA002

Table ASSVFEAT was created.

ASSVLINK

Table name

Assisted Service Link Table

Functional description

This table associates network facility access (NFA) trunk members with multiprotocol controller (MPC) application names. These groupings allow NFA call traffic to be segregated across different sets of MPC X.25 links. NFA trunk members are datafilled in tables CLLI, TRKGRP, TRKSGRP, and TRKMEM. In table ASSVLINK, each NFA trunk member can be associated with an MPCLSET link set. The logical links datafilled in the MPCLSET table are used for messages corresponding to calls sent over the NFA trunk members datafilled in this table.

Datafill sequence and implications

The following tables must be datafilled before table ASSVLINK:

- MPCFASTA
- MPCLSET
- CLLI
- TRKGRP
- TRKSGRP
- TRKMEM

Table size

This table is stored in segmented store and is dynamically allocated depending on the number of MPCLSET entries and the number of NFA TRKMEM entries. The maximum number of entries is 10000.

ASSVLINK (continued)**Datafill**

The following table lists datafill for table ASSVLINK.

Field descriptions for table ASSVLINK

Field	Subfield or refinement	Entry	Explanation and action
ASSVLINK		see subfields	<i>Assisted Service link</i> This field names the NFA trunk member with which to associate a link set defined in table MPCLSET. It consists of subfields CLLI and MEMNAME.
	CLLI	alphanumeric (1 to 16 characters)	<i>Common Language location identifier</i> Enter the NFA trunk name datafilled in tables CLLI, TRKGRP, TRKSGRP, and TRKMEM.
	MEMNAME	numeric (0 to 9999)	<i>Member name</i> Enter the trunk member number datafilled in table TRKMEM.
MPCAPPLN		ASSVDAT1 ASSVDAT2 ASSVDAT3 ASSVDAT4 ASSVDAT5 ASSVDAT6	<i>MPC application</i> Enter the name of the application in table MPCLSET that contains the MLC assignment for the trunk member. Note: If Assisted Service X.25 Data Link Interface (AN0831) is deployed in a 100/TOPS Combo software load, only ASSVDAT1 and ASSVDAT2 applications are available.
MPCSET		(0 to 15)	<i>MPC set index</i> Enter the index of the application in table MPCLSET that contains the MLC assignment for the trunk member.

Datafill example

The following example shows sample datafill for table ASSVLINK.

MAP display example for table ASSVLINK

CLLI	EXTRKNM	LSETIDX
NFACLLI	0	ASSVDAT1 0
NFACLL1	1	ASSVDAT1 0
NFACLLI	3	ASSVDAT1 0
NFACLLI2	0	ASSVDAT1 0
NFACLL13	1	ASSVDAT1 1

Table history**NA002**

Table ASSVLINK was created.

ATMEQ

Table name

Automatic Transmission Measuring Equipment Q Table

Functional description

Table ATMEQ lists three frequencies: base (804 Hz, 1004 Hz or 1020 Hz), 404 Hz, and 2804 Hz. Table ATMEQ lists two Q limits: low Q values for negative deviation and high Q values for positive deviation. The Q values for noise are in table ATMEQ.

Compare the measurement of the loss at the base frequency (804 Hz or 1004 Hz) with the expected measured loss (EML). If the deviation from the EML is negative, use the two values in field QBASEL. These values are low Q values. If the deviation is positive, the two values in field QBASEH are used. These values are high Q values.

The deviation from the EML has the following indications for field QBASEL:

- the trunk can remain in service and requires maintenance if the following deviation is present. The deviation must be greater or equal to the value in subfield Q1 and less than the value in subfield Q2. Subfield Q1 is the maintenance level and subfield Q2 is the service level.
- if the deviation is greater or equal to the value in subfield Q2, remove the trunk from service for maintenance.

The deviation from the EML contains the following indications for field QBASEH:

- the trunk can remain in service and requires maintenance if the following deviation is present. The deviation must be greater or equal to the value in subfield Q1 and less than the value in subfield Q2.
- if the deviation is greater or equal to the value in subfield Q2, remove the trunk from service for maintenance.

Compare the measurement of the loss at 404 Hz or 2804 Hz with the measured loss at the base frequency. Compare the difference between the loss at the base frequency and the loss at 404 Hz or 2804 Hz. If the difference is negative, perform the following procedure. Use the two values in either field Q400L or field Q2800L (low Q values). Use the two values in either field Q400H or field Q2800H (high Q values) if the difference is positive.

ATMEQ (continued)

The difference has the following indications for field Q400L or field Q2800L:

- the trunk can remain in service and requires maintenance if the following difference is present. The difference must be greater or equal to the value in subfield Q1 and less than the value in subfield Q2.
- if the difference is greater or equal to the value in subfield Q2, remove the trunk from service for maintenance.

The difference has the following indications for field Q400H or field Q2800H:

- the trunk can remain in service and requires maintenance if the following difference is present. The difference is greater or equal to the value in subfield Q1 and less than the value in subfield Q2.
- if the difference is greater or equal to the value in subfield Q2, remove the trunk from service for maintenance.

The values in field QNOISE, and the two subfields, Q1 and Q2, have negative values. Check if the measured noise value (disregarding sign) is greater than the value in subfield Q2. If the value is less than or equal to the value in subfield Q1, the trunk can be left in service. The trunk requires maintenance. Check if the measured noise value (disregarding sign) is less than or equal to the value in subfield Q2. If the value is less than or equal to subfield Q2, remove the trunk from service for maintenance.

Note: When the values in subfields Q1 and Q2 of field QNOISE are negative, less noise occurs because of the larger value. For example, a value of 60 means -60 dB and a value of 50 means -50 dB. The noise level of -50 dB is greater than a noise level of -60 dB.

Datafill sequence and meaning

You do not have to enter data in other tables before you enter data in table ATMEQ.

Table size

32 tuples

ATMEQ (continued)**Datafill**

Datafill for table ATMEQ appears in the following table.

Field descriptions (Sheet 1 of 5)

Field	Subfield or refinement	Entry	Explanation and action
QINDEX		0 to 31	<i>Q index.</i> Enter the index in table ATMEQ. The index is in table D3MAINTD.
QBASEL		see subfields	<i>Low value Q for base frequency ATME2 level measurement.</i> This field contains subfields Q1 and Q2.
	Q1	00 to 99	<i>Maintenance level.</i> If the measured value is less than the level in this subfield, the circuit meets the maintenance requirement. If the measured value is greater or equal to this value but is less than the value in subfield Q2, perform the following. Mark the circuit as defective (fails Q1 limits). Note: Entries are in steps of 0.1 dB (entry 69 = 6.9 dB).
	Q2	00 to 99	<i>Service level.</i> If the measured value is greater or equal to the level in this subfield indicates, perform the following. Mark the circuit as defective and not operational (fails Q2 limit). Remove the circuit from service. Note: Entries are in steps of 0.1 dB (entry 69 = 6.9 dB). The Q2 level is always greater or equal to the Q1 level.
QBASEH		see subfields	<i>High value Q for base frequency ATME2 level measurement.</i> This field contains subfields Q1 and Q2.

ATMEQ (continued)

Field descriptions (Sheet 2 of 5)

Field	Subfield or refinement	Entry	Explanation and action
Q400L	Q1	00 to 99	<p><i>Maintenance level.</i> If the measured value is less than the level that this subfield indicates, the circuit meets the maintenance requirement. If the measured value is greater or equal to this value and is less than the value in subfield Q2, perform the following. Mark the circuit as defective (fails Q1 limits).</p> <p>Note: Entries are in steps of 0.1 dB (entry 69 = 6.9 dB).</p>
	Q2	00 to 99	<p><i>Service level.</i> If the measured value is greater or equal to the level indicated in this subfield, perform the following. Mark the circuit as defective and not operational (fails Q2 limit). Remove the circuit from service.</p> <p>Note: Entries are in steps of 0.1 dB (entry 69 = 6.9 dB). The Q2 level is always greater or equal to the Q1 level.</p>
	see subfields		<p><i>Low value Q for 400-Hz ATME2 level measurement.</i> This field contains subfields Q1 and Q2.</p>
	Q1	00 to 99	<p><i>Maintenance level.</i> If the measured value is less than the level in this subfield, the circuit meets the maintenance requirement. If the measured value is greater or equal to this value but is less than the value in subfield Q2, perform the following. Mark the circuit defective (fails Q1 limits).</p> <p>Note: Entries are in steps of 0.1 dB (entry 69 = 6.9 dB).</p>

ATMEQ (continued)

Field descriptions (Sheet 3 of 5)

Field	Subfield or refinement	Entry	Explanation and action
Q400H	Q2	00 to 99	<p><i>Service level.</i> If the measured value is greater or equal to the level indicated in this subfield, mark the circuit as defective and not operational (fails Q2 limit). Remove the circuit from service.</p> <p>Note: Entries are in steps of 0.1 dB (entry 69 = 6.9 dB). The Q2 level is always greater or equal to the Q1 level.</p>
		see subfields	<p><i>High value Q for 400-Hz ATME2 level measurement.</i> This field contains subfields Q1 and Q2.</p>
	Q1	00 to 99	<p><i>Maintenance level.</i> If the measured value is less than the level indicated in this subfield, the circuit meets the maintenance requirement. If the measured value is greater or equal to this value and is less than the value in subfield Q2, perform the following. Mark the circuit as defective (fails Q1 limits).</p> <p>Note: Entries are in steps of 0.1 dB (entry 69 = 6.9 dB).</p>
Q2800L	Q2	00 to 99	<p><i>Service level.</i> If the measured value is greater than or equal to the level indicated in this subfield, perform the following. Mark the circuit as defective and is not operational (fails Q2 limit). Remove the circuit from service.</p> <p>Note: Entries are in steps of 0.1 dB (entry 69 = 6.9 dB). The Q2 level is always greater or equal to the Q1 level.</p>
		see subfields	<p><i>Low value Q for 2800-Hz ATME2 level measurement.</i> This field contains subfields Q1 and Q2.</p>

ATMEQ (continued)

Field descriptions (Sheet 4 of 5)

Field	Subfield or refinement	Entry	Explanation and action
Q2800H	Q1	00 to 99	<p><i>Maintenance level.</i> If the measured value is less than the level indicated in this subfield, the circuit meets the maintenance requirement. If the measured value is greater or equal to this value and is less than the value in subfield Q2, perform the following. Mark the circuit as defective (fails Q1 limits).</p> <p>Note: Entries are in steps of 0.1 dB (entry 69 = 6.9 dB).</p>
	Q2	00 to 99	<p><i>Service level.</i> If the measured value is greater or equal to the level indicated in this subfield, mark the circuit as defective and not operational (fails Q2 limit). Remove the circuit from service.</p> <p>Note: Entries are in steps of 0.1 dB (entry 69 = 6.9 dB). The Q2 level is always greater or equal to the Q1 level.</p>
		see subfields	<p><i>High value Q for 2800-Hz ATME2 level measurement.</i> This field contains subfields Q1 and Q2.</p>
	Q1	00 to 99	<p><i>Maintenance level.</i> If the measured value is less than the level indicated in this subfield, the circuit meets the maintenance requirement. If the measured value is greater or equal to this value but is less than the value in subfield Q2, perform the following. Mark the circuit as defective (fails Q1 limits).</p> <p>Note: Entries are in steps of 0.1 dB (entry 69 = 6.9 dB).</p>

ATMEQ (continued)

Field descriptions (Sheet 5 of 5)

Field	Subfield or refinement	Entry	Explanation and action
QNOISE	Q2	00 to 99	<p><i>Service level.</i> If the measured value is greater or equal to the level indicated in this subfield, perform the following. Mark the circuit as defective and not operational (fails Q2 limit). Remove the circuit from service.</p> <p>Note: Entries are in steps of 0.1 dB (entry 69 = 6.9 dB). The Q2 level is always greater or equal to the Q1 level.</p>
		see subfields	<p><i>Q for noise ATME2 power measurement.</i> This field contains subfields Q1 and Q2.</p>
	Q1	00 to 99	<p><i>Maintenance level.</i> If the measured value is greater than this value, the circuit requires maintenance but is functional. If the measured value is less or equal to this value but is greater than the value in subfield Q2, perform the following. Mark the circuit as defective (fails Q1 limits).</p> <p>Note: Entries are in steps of -1 dBm0p (entry 69 = -69 dBm0p) (decibel output power [1 mW reference]).</p>
	Q2	00 to 99	<p><i>Service level.</i> If the measured value is less or equal to this level, mark the circuit as defective and not operational (fails Q2 limit). Remove the circuit from service.</p> <p>Note: Entries are in steps of -1 dBm0p (entry 69 = -69 dBm0p). The Q2 level is always less or equal to the Q1 level.</p>

Datafill example

Sample datafill for table ATMEQ appears in the following example.

This example specifies the following conditions:

- the QINDEX is 1
- trunks measured at the base frequency with a negative deviation from EML of 1.5 dB require maintenance

ATMEQ (end)

- remove trunks from service for maintenance that measure at the base frequency with a negative deviation from EML of 3.5 dB
- trunks measured at the base frequency with a positive deviation from EML of 1.0 dB require maintenance
- remove trunks from service for maintenance that measure at the base frequency with a positive deviation from EML of 3.0 dB
- trunks measured at 404 Hz or 2804 Hz with a negative deviation from the loss measured at the base frequency of 1.5 dB require maintenance
- remove trunks from service for maintenance that measure at 404 Hz or 2804 Hz with a negative deviation from the loss measured at the base frequency of 3.5 dB
- trunks measured at 404 Hz or 2804 Hz with a positive deviation from the loss measured at the base frequency of 1.2 dB require maintenance.
- remove trunks from service for maintenance that measure at 404 Hz or 2804 Hz with a positive deviation from the loss measured at the base frequency of 3.2 dB.
- the maintenance power level for noise is -50 dBm0p
- the service power level for noise is -30 dBm0p

MAP example for table ATMEQ

QINDEX	QBASEL	QBASEH	Q400L	Q400H	Q2800L	Q2800H	QNOISE
1	15 35	10 30	15 35	12 32	15 35	12 32	50 30

ATMFWDA

Table name

ATM framework states data

Functional description

This table stores the ATM framework states of each SPM or MG 4000 peripheral.

This table is created mainly for ONP. During dump and restore, the restore side will use this table to configure the ATM FRAMEWORK STATES from other side on Core. The size of the table is the maximum SPM number in system.

Datafill sequence and meaning

The table is automatically initialized during IPL. All the data in the table will be unchanged during RELOAD/COLD/WARM restarts. Datafill is controlled exclusively by the module SPMTRKUT at running time. Changes are made only when the module SPMTRKUT receives notification of changes from local and CCMT.

Table size

Table ATMFWDA can support up to 86 tuples

Datafill

The following table lists datafill for table ATMFWDA.

Field descriptions

Field	Subfield	Entry	Explanation and action
NODEINX		0 to 85	Key field. Enter the SPM number.
LOATMST		0 to 5	Local ATM framework state.
VCCINSV		0 or 1	Store Core site VSS status.
CAPABLE		0 to 2	ATM trunking capability status
REGISTD		0 or 1	Registration status

Datafill example

The following figure shows sample datafill for table ATMFWDA.

-4 New or changed data schema tables

MAP display example for table ATMFWDA

NODEINX	LOATMST	VCCINSV	CAPABLE	REGISTD
1	5	1	0	1

Table History

This table was introduced in CSP14.

ATPIES

Table name

ISUP Access Transport Parameter Information Element Table

Functional description

Table ATPIES allows the operating company to choose the information elements (IE) to include in the ISDN user part (ISUP) access transport parameter (ATP).

The operating company can include all, some, or none of the ATPs, based on the datafill in table ATPIES.

Datafill sequence and implications

There is no requirement to datafill other tables prior to table ATPIES.

Table size

0 to 16 tuples

Memory is statically allocated for 16 tuples. The number of tuples in table ATPIES does not affect data store usage.

ATPIES (continued)**Datafill**

The following table lists datafill for table ATPIES.

Field descriptions

Field	Subfield or refinement	Entry	Explanation and action
ATPIEKEY		0 to 15	<p><i>Access transport parameter information element key</i> Enter the ATPIES index key.</p> <p>This numeric index is used in field ATPIDX of table TRKSGRP to determine the list of information elements (IE) to include in the access transport parameter (ATP) if an ISDN user part (ISUP) connection is made on a trunk.</p>
IEINCL		ALL, CDSA, CGSA, HLC, LLC, PI, or \$	<p><i>Information elements included</i> Enter the information elements included in the ATP for calls on ISUP trunks.</p> <p>Enter ALL if all information elements are included.</p> <p>Enter CDSA if the called party subaddress IE is included.</p> <p>Enter CGSA if the calling party subaddress IE is included.</p> <p>Enter HLC if the high-layer compatibility IE is included.</p> <p>Enter PI if the progress indicator IE is included. A PI is never included in an ATP of a generated ISUP message, but a PI can be included in an ATP of a received ISUP message.</p> <p>Enter \$ if no information elements are included or to indicate the end of the tuple.</p>

Datafill example

The following example shows sample datafill for table ATPIES.

ATPIES (end)

MAP display example for table ATPIES

ATPIEKEY	IEINCL
0	(PI) \$
1	(CDSA) (CGSA) (LLC) (HLC) \$
3	\$

Table history

BCS34

Table ATPIES was introduced.

ATQMSMD**Table name**

Charge Calculator Attribute Queue Management System Discount and Surcharge Modification Table

Functional description

Table ATQMSMD permits surcharges on a per QMS service basis. This table defines percent and fixed amount surcharges or discounts on the same call based on the incoming schedule and QMS service. And, this table allows a maximum surcharge of 1000% and a maximum discount of 100% to be datafilled.

Datafill sequence and implications

Tables SCHNAME and TQMSSERV must be datafilled before table ATQMSMD.

Table size

The table size is based on the maximum number of tuples in tables SCHNAME (64) and TQMSSERV (63). Therefore, there are $64 \times 63 = 4032$ tuples in table ATQMSMD.

Activation

Table TOPSPARM parameter NUMBERING_PLAN must be set to OPEN_NUMBERING and field SRVBILL in table TQMSSERV must be set to SURCHARGE.

Datafill

The following table lists datafill for table ATQMSMD.

Datafilling table ATQMSMD (Sheet 1 of 2)

Field	Subfield or refinement	Entry	Explanation and action
INDEX		see subfields	Index. This field consists of subfields SCHNAME and SVCLIST.
	SCHNAME	SCHNAME from table SCHNAME	Schedule name. Key into table. Value must be defined in table SCHNAME, field SCHNAME.
	SVCLIST	QMSSERV from table TQMSSERV	Service list . Key into table. Value must be defined in table TQMSSERV, field QMSSERV.

ATQMSMD (end)**Datafilling table ATQMSMD (Sheet 2 of 2)**

Field	Subfield or refinement	Entry	Explanation and action
SENSEPER		SUR or DISC	Sense percent. Values are for percent surcharge (SUR) and percent discount (DISC). Default is SUR.
PERCENT		0-1000	Percent. Range is 0-1000 when field SENSEPER=SUR, or 0-100 when SENSEPER=DISC. Default is 0.
SENSEFIX		SUR or DISC	Sense fixed. Values are for a fixed surcharge amount (SUR) and a fixed discount amount (DISC). Default is SUR.
FIXED		0-32767	Fixed amount. Range is valid when field SENSEFIX is SUR or DISC. Default is 0.

Datafill example

The following example shows sample datafill for table ATQMSMD.

MAP display example for table ATQMSMD

	INDEX	SENSEPER	PERCENT	SENSEFIX	FIXED
SCHCLG0NAT	4	SUR	0	DISC	20
SCHCLG0LOC	3	SUR	400	SUR	0

Table history**TOPS03**

Table introduced by feature AN1085 in GOS Enhancements, GOS00001.

ATRIMOD

Table name

ITOPS Rating Charge Calculator Attribute Discount and Surcharge Table

Functional description

International Traffic Operator Position System (ITOPS) table ATRIMOD defines the discount or surcharge to be applied to the charges based on the incoming schedule and the call characteristics (call origination type and call attribute set) of a call.

Table ATRIMOD is used when

- field ATTRIB in table CHGHEAD = Y for the incoming schedule name and ratestep
- a match for the call characteristics is found in table ATTRIB where field INDEX then points to field ATTRIB in tables CHGATRIB and ATRIMOD

The system then calculates the call-characteristics-dependent charges using table CHGATRIB (superseding default charges defined in table CHGHEAD) and applies the discount or surcharge using table ATRIMOD.

When call-characteristics-dependent charge and discount or surcharge rates apply, the system calculates the charges using tables ATTRIB, CHGATRIB, and ATRIMOD, superseding default charge rates of table CHGHEAD, and then proceeds to calculate the date- and time-dependent discount or surcharge starting with table TIMEZONE.

ITOPS rating system tables

The ITOPS rating system tables contain the operating company dependent data required to automatically calculate, on a real-time basis, the rate step and charges for certain ITOPS calls. The list of the ITOPS rating system tables follows:

- ATRIMOD
- ATTRIB
- CHGATRIB
- CHGHEAD
- CLGSSET
- HOLIDAY
- HOLITRMT
- MODMAP

ATRIMOD (continued)

- MODSET
- RATEMOD
- RNDING
- RSNAT
- RSAFOR
- RSLOC
- SCHNAME
- SCHEDEF
- SSETNAME
- TAXFIX
- TAXMAPS
- TAXRATE
- TIMEZONE

Types of calls using the ITOPS rating system

The automatic message accounting (AMA) system records all chargeable or billable toll calls originating from coin and noncoin (including hotel) stations. The AMA tape records are used in the operating company by accounting programs to bill the subscribers at a later date.

All such calls, however, are not necessarily rated by the ITOPS rating system. Only coin-paid calls and calls requiring a quotation to the subscriber are rated by the ITOPS rating system.

ITOPS rating system tables

The ITOPS rating system tables are organized, as shown in figure “ITOPS rating system flowchart” of the ITOPS rating system flowchart, into two table types

- ITOPS rating rate step calculator tables
- ITOPS rating charge calculator tables

ITOPS rating rate step calculator tables

The ITOPS rating rate step calculator tables, listed as items “ATRIMOD” and “:TIMEZONE”, are used to automatically determine

- the schedule set name (SSETNAME),
- the schedule name (SCHNAME), and
- the rate step

ATRIMOD (continued)

These characteristics are determined from the calling number and the called number validated and identified by digit translation tables to be national local, national toll, or foreign toll.

The SSETNAME, SCHNAME, and rate step are used to index various ITOPS rating charge calculator tables as described later.

SSETNAME

A schedule set name (SSETNAME) must first be entered in table SSETNAME, which is a list of all schedule set names, before it can be used in any other table.

A SSETNAME is associated in table CLGSET with one or more calling numbers or ranges of calling numbers. Table CLGSET thus maps a calling area to a SSETNAME.

The SSETNAME is used as an index into tables RSLOC, RSNAT, RSFOR, TAXMAPS, TAX, and RNDING as described later.

SCHNAME and rate step

A schedule name (SCHNAME) must first be entered in table SCHNAME, which is a list of all schedule names, before it can be used in any other table.

A SCHNAME is associated in table SCHEDEF with

- a rate step or a range of rate steps
- one of the three termination types: local, national, or foreign

Table SCHEDEF defines combinations of schedule names and rate step ranges for use on local, national, and foreign calls. Before a schedule name and rate step combination may be datafilled in tables RSLOC (local rating), RSNAT (national rating), or RSFOR (foreign rating), it must be known and associated in table SCHEDEF with a termination type of LOCAL, NATIONAL, or FOREIGN, respectively.

Table RSLOC is accessed when the translation of dialed digits identifies a national local call. Table RSLOC is indexed by the SSETNAME associated with the calling number. Table RSLOC defines the SCHNAME and rate step (LOCAL in table SCHEDEF) to be used when rating national local calls for each SSETNAME.

Table RSNAT is accessed when the translation of dialed digits identifies a national toll call. Table RSNAT is indexed by the SSETNAME associated with the calling number, and the leading digits of the called number. Table RSNAT defines the SCHNAME and rate step (NATIONAL in table SCHEDEF) to be

ATRIMOD (continued)

used when rating national toll calls for each combination of SSETNAME and called number digits.

Table RSFOR is accessed when the translation of dialed digits identifies a foreign toll call. Table RSFOR is indexed by the SSETNAME associated with the calling number and the leading digits of the called number. Table RSFOR defines the SCHNAME and rate step (FOREIGN in table SCHEDEF) to be used when rating foreign toll calls for each combination of SSETNAME and called number digits.

The SCHNAME and rate step together are used as an index into table CHGATRIB and the SCHNAME is used as an index into tables ATRIMOD, HOLITRMT, MODMAP, and RATEMOD as described later.

ITOPS rating charge calculator tables

The ITOPS rating charge calculator tables, as shown in figure “ITOPS rating system flowchart” of the ITOPS rating system flowchart, are used to automatically calculate the charges as follows:

- charges are based either on the default charges or the charges on call characteristics, including discounts or surcharges
- the discounts or surcharges are based on the originator's time, day of week, date, applicable taxes, and rounding

Charges are determined from the following call attributes:

- SSETNAME
- SCHNAME
- rate step
- the originator's time, day, and date when the call is started and terminated

Default charges

Table CHGHEAD lists the default charges as shown in figure “ITOPS rating system flowchart: Determination of default charge rates” of the ITOPS rating system flowchart. Default charges may be superseded by charges determined by the call characteristics as described later.

Default charges consist of

- the class charge, which is added to the base cost of the call (combined initial and subsequent charges)

Note: Normally, on an operator handled call, the initial period rate contains a charge to compensate for operator assistance. The class

ATRIMOD (continued)

charge is then 0 (zero). However, when initial period discounting is enabled (table RATEMOD, field MODINP = Y) and operator assistance is not to be discounted, then the operator assistance portion is defined as a class charge.

- initial period charges
- subsequent period charges

Call-characteristics-dependent charges

Default charges may be superseded by the charges specified in table CHGATTRIB, based on specific combinations of call characteristics defined in table ATTRIB.

Figure “ITOPS rating system flowchart: Determination of call-characteristic-dependent charge and discount or surcharge rates“ of the rating system flowchart shows how call-characteristic-dependent charge rates are obtained from table CHGATTRIB via table ATTRIB while figure “ITOPS rating system flowchart: Time-, day-, and date-dependent calculation of discounts and surcharges“ shows how call-characteristic-dependent charges are calculated.

Time-, day-, and date-dependent discount or surcharge

After charge calculations, there may be a time-, day-, and date-dependent discount or surcharge specified in the appropriate entries in table RATEMOD. The appropriate entries in table RATEMOD are determined from the calling number, the SCHNAME, and the system time, day, and date from tables TIMEZONE, HOLIDAY, HOLITRMT, MODMAP, and MODSET, as shown in figures “ITOPS rating system flowchart: Determination of originator’s date, time and day“ and figure “ITOPS rating system flowchart: Determination of discount or surcharge rates based on originator’s date, time, and day“ of the ITOPS rating system flowchart. Figure “ITOPS rating system flowchart: Time-, day-, and date-dependent calculation of discounts and surcharges“ shows how these discounts or surcharges are calculated.

Call-characteristics-dependent discount or surcharge

Following discount or surcharge calculations based on time, day, and date, there may be a call characteristics dependent discount or surcharge specified in table ATRIMOD, based on specific combinations of call characteristics defined in table ATTRIB. Figure “ITOPS rating system flowchart: Determination of call-attribute-dependent charge and discount or surcharge rates“ of the rating system flowchart shows how these discount or surcharges are obtained from table ATRIMOD, by way of tables ATTRIB and CHGATTRIB, and figure “ITOPS rating system flowchart: Call attribute

ATRIMOD (continued)

dependent calculation of discount and surcharge“shows how the call-characteristics-dependent discount or surcharge is calculated.

Taxes and rounding

Tax and rounding calculations use values from various table fields as detailed below and illustrated in the rating system flowchart figure “ITOPS rating system flowchart: Calculation of taxes and rounding for coin lines“ for calls originated by a coin station and figure “ITOPS rating system flowchart: Calculation of taxes and rounding for noncoin lines“ for calls originated by a noncoin station.

The table fields used for tax and rounding calculations are derived as follows:

Applicable taxes

As shown in figure “ITOPS rating system flowchart: Determination of tax and rounding fields“ of the rating system flowchart, table TAXMAPS is indexed by SSETNAME and SCHNAME. Table TAXMAPS defines which taxes apply for each specified combination of SSETNAME and SCHNAME. Up to three separate taxes may be called for or not (for example federal, state, and local) by setting each of the fields TAX1, TAX2, and TAX3 to Y (yes) or N (no).

Tax rates and compounding

As shown in figure “ITOPS rating system flowchart: Determination of tax and rounding fields“ of the rating system flowchart table TAX is indexed by SSETNAME. Table TAX defines each of the three tax rates (fields RATE1, RATE2, and RATE3), and whether the second and third tax should be compounded (fields COMP2 and COMP3).

When COMP2 = Y,

$$\begin{aligned} \mathbf{tax2_amount} \\ &= (\text{pre_tax_amount} + \text{tax1_amount}) \times \text{RATE2} \end{aligned}$$

otherwise, when COMP2 = N,

$$\begin{aligned} \mathbf{tax2_amount} \\ &= \text{pre_tax_amount} \times \text{RATE2} \end{aligned}$$

Similarly, when COMP3 = Y,

$$\begin{aligned} \mathbf{tax3_amount} \\ &= (\text{pre_tax_amount} + \text{tax1_amount} + \text{tax2_amount}) \times \text{RATE2} \end{aligned}$$

otherwise, when COMP3 = N,

$$\begin{aligned} \mathbf{tax3_amount} \\ &= \text{pre_tax_amount} \times \text{RATE3} \end{aligned}$$

ATRIMOD (continued)

Rounding

As shown in figure “ITOPS rating system flowchart: Determination of tax and rounding fields“ of the rating system flowchart, table RNDING is indexed by SSETNAME. Table RNDING allows the specification of rounding at various stages of tax calculation as detailed in the description of table RNDING and shown in figures “ITOPS rating system flowchart: Calculation of taxes and rounding for coin lines“ and figure “ITOPS rating system flowchart: Calculation of taxes and rounding for noncoin lines” of the rating system flowchart.

ATRIMOD (continued)

ITOPS rating system flowchart

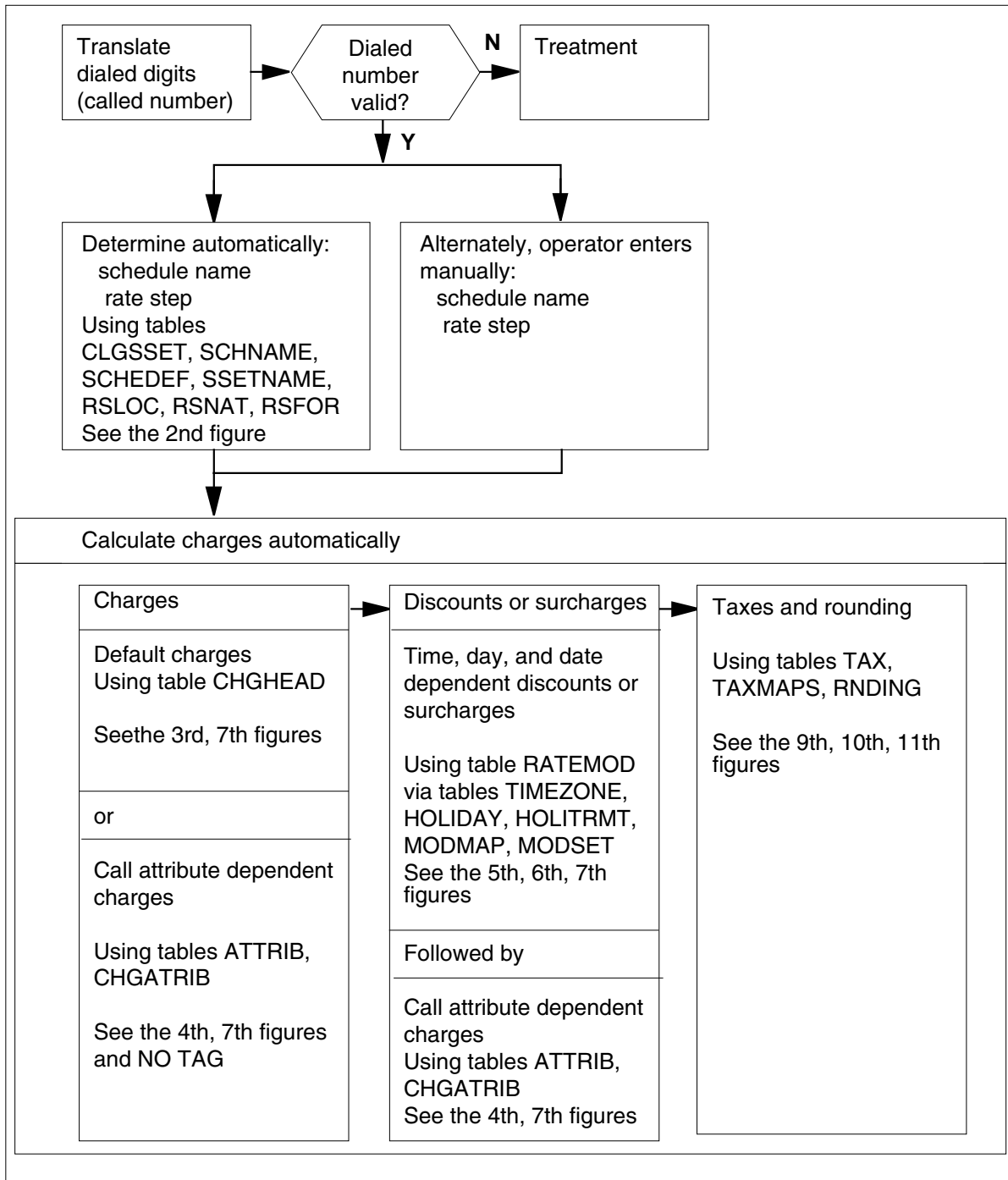

ATRIMOD (continued)

ITOPS rating system flowchart : Automatic determination of the schedule name and rate step

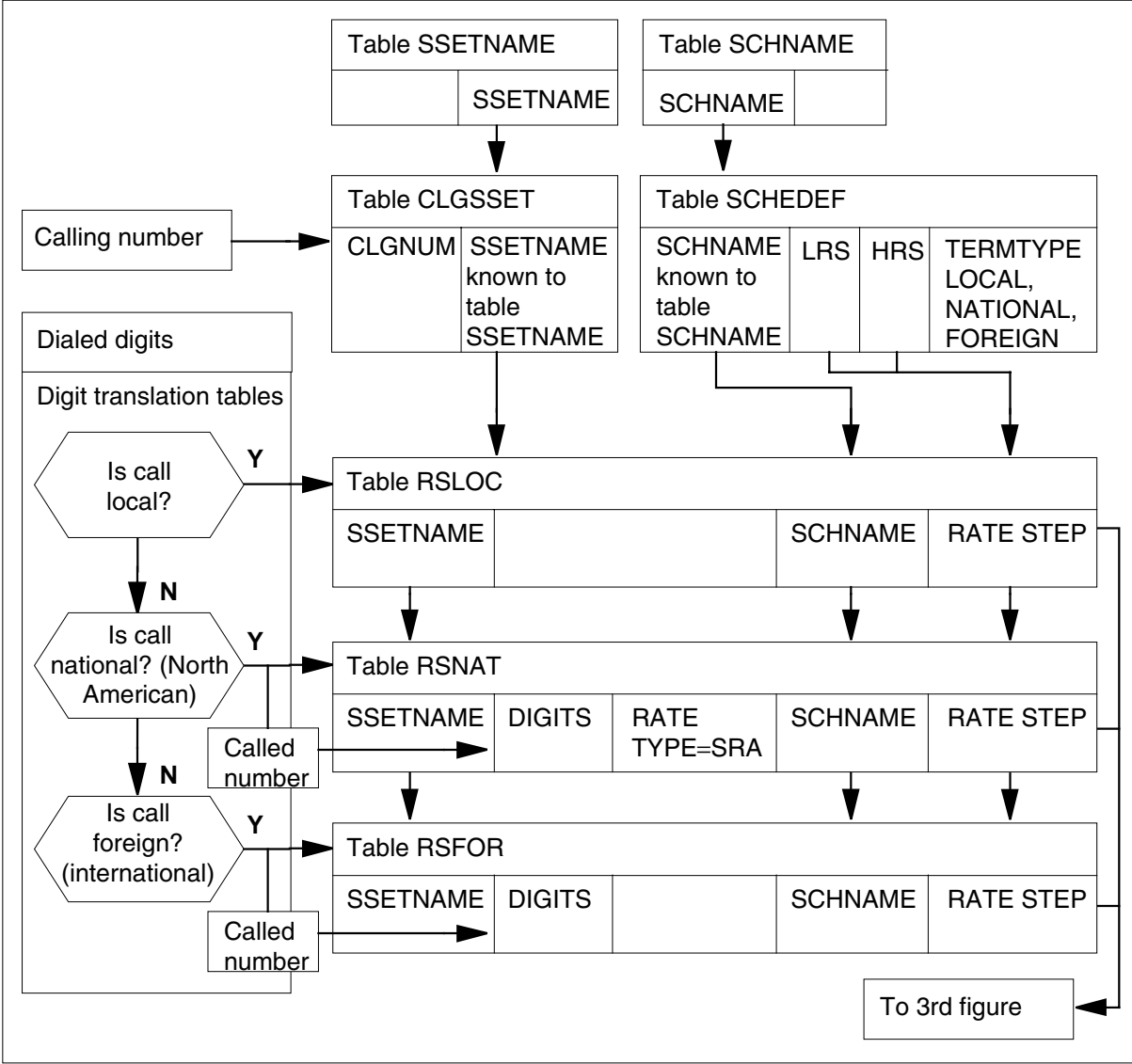

ATRIMOD (continued)

ITOPS rating system flowchart : Determination of default charge rates

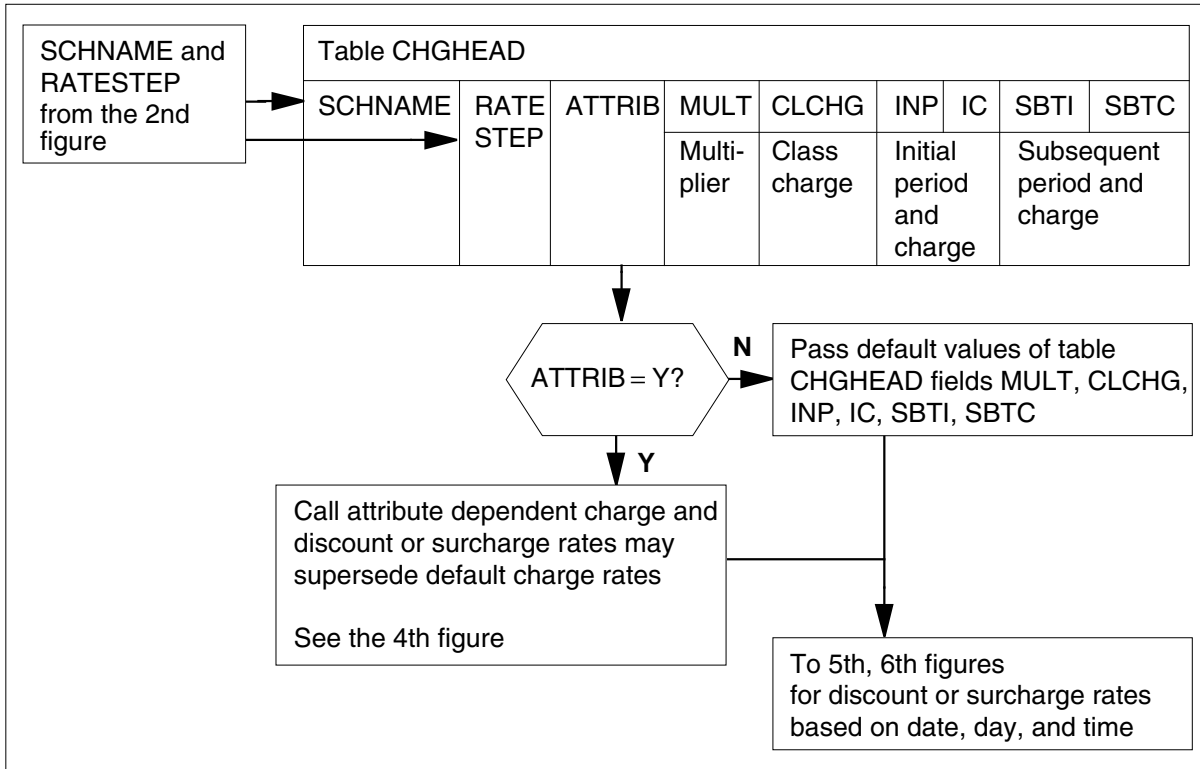

ATRIMOD (continued)

ITOPS rating system flowchart : Determination of call-attribute-dependent charge and discount or surcharge rates

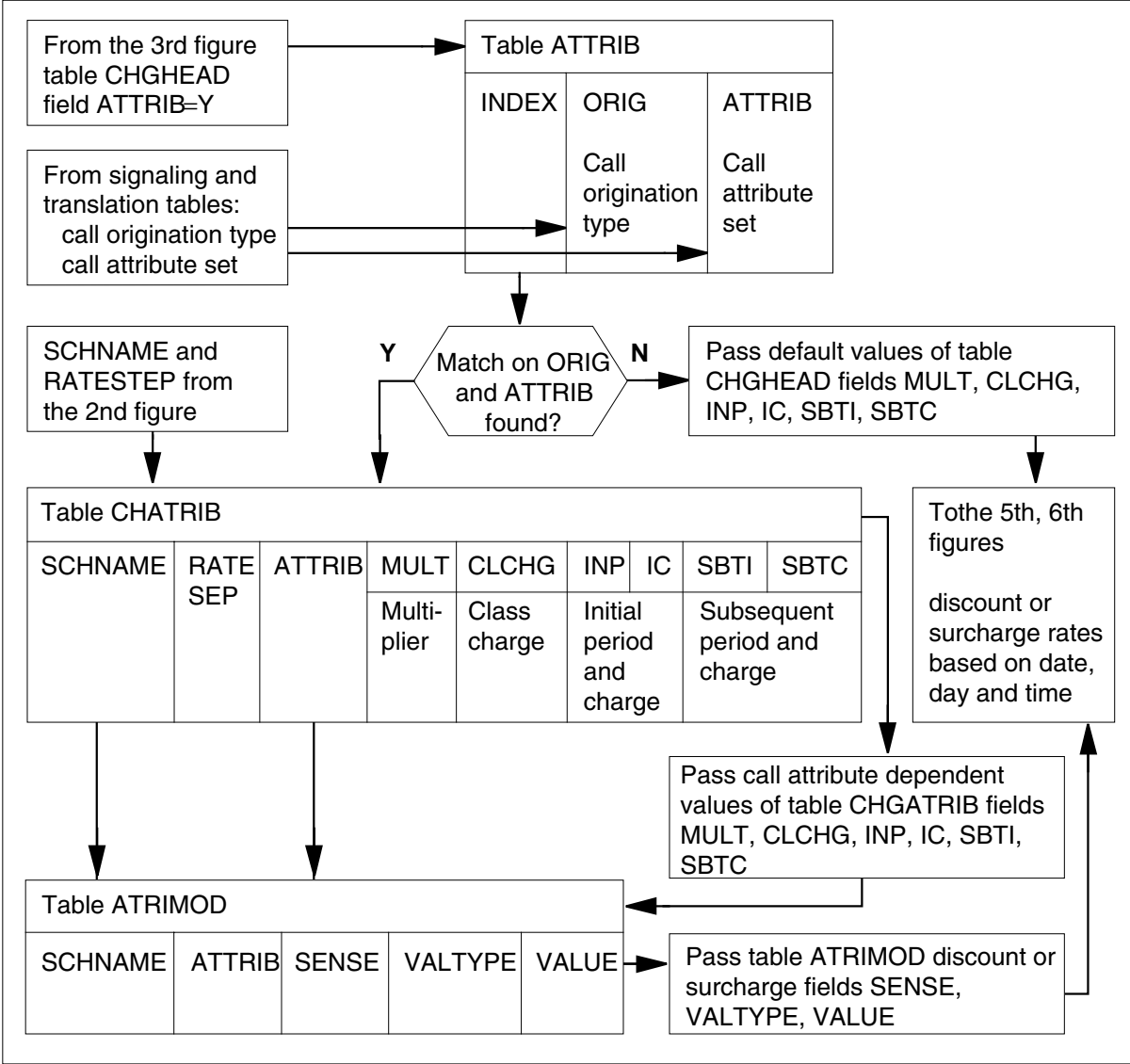

ATRIMOD (continued)

ITOPS rating system flowchart : Determination of originator's date, time, and day

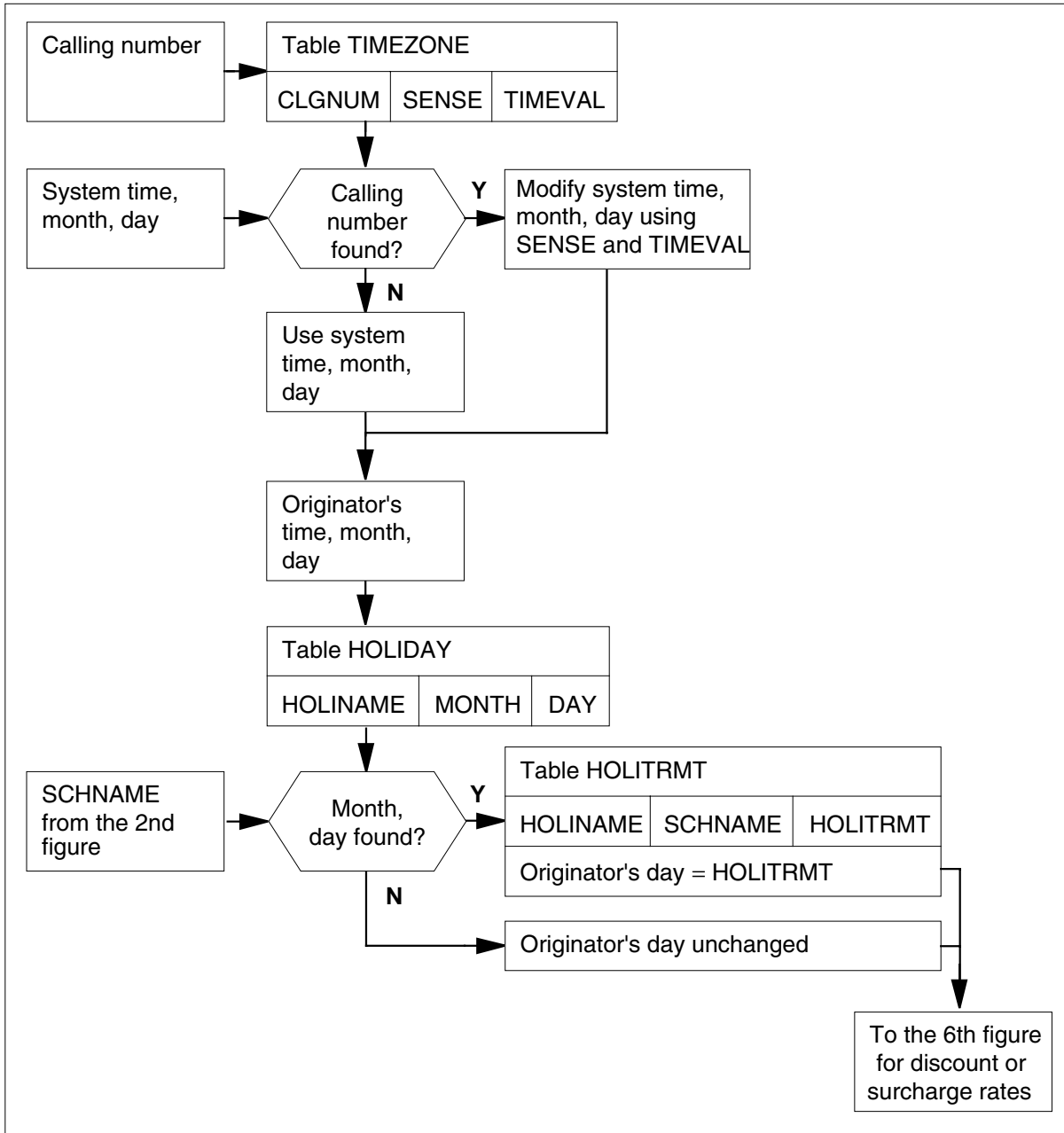

ATRIMOD (continued)

ITOPS rating system flowchart : Determination of discount or surcharge rates based on originator's date, time, and day

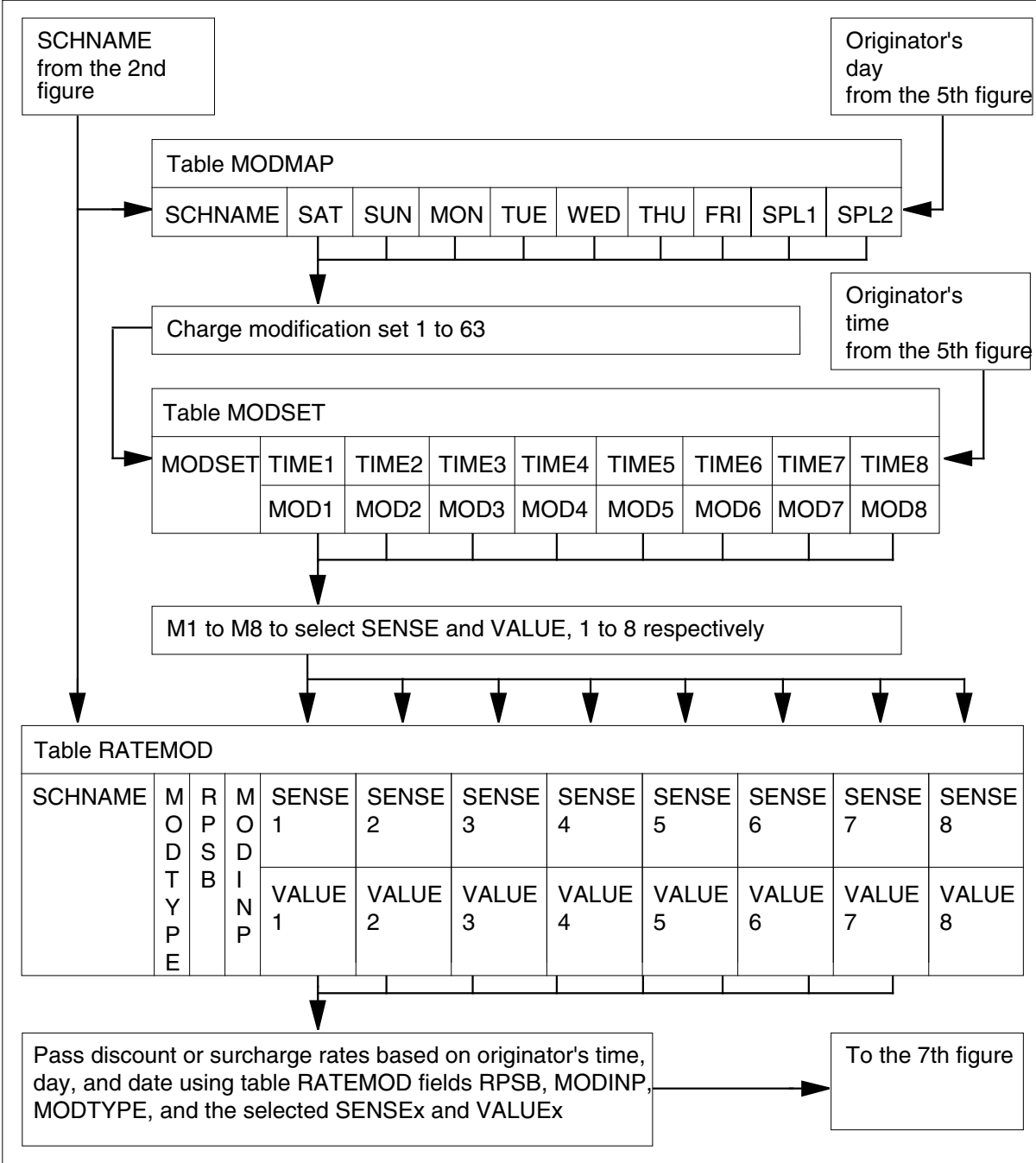

ATRIMOD (continued)

ITOPS rating system flowchart : Time-, day-, and date-dependent calculation of discounts and surcharges

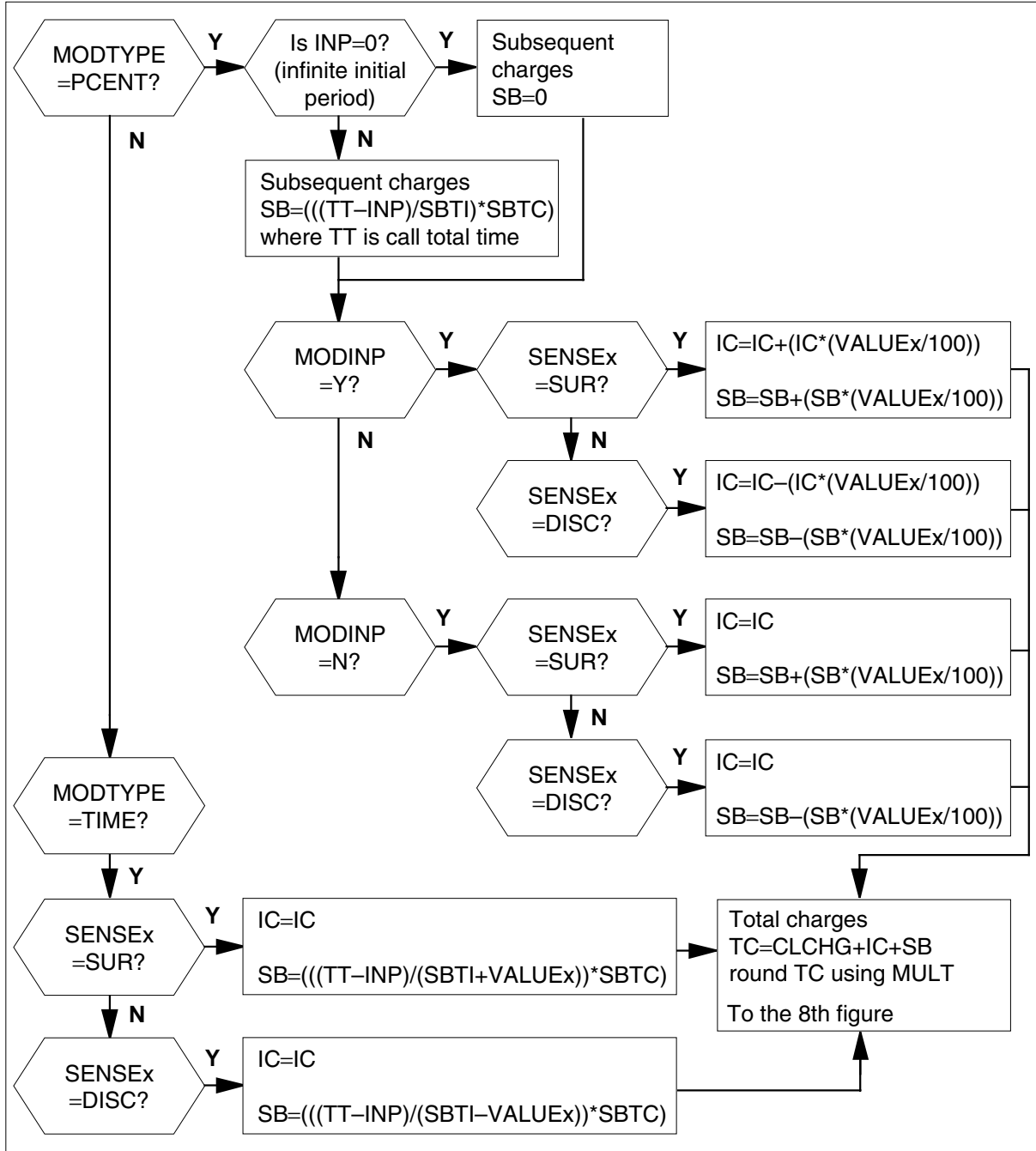

ATRIMOD (continued)

ITOPS rating system flowchart : Call attribute dependent calculation of discount and surcharge

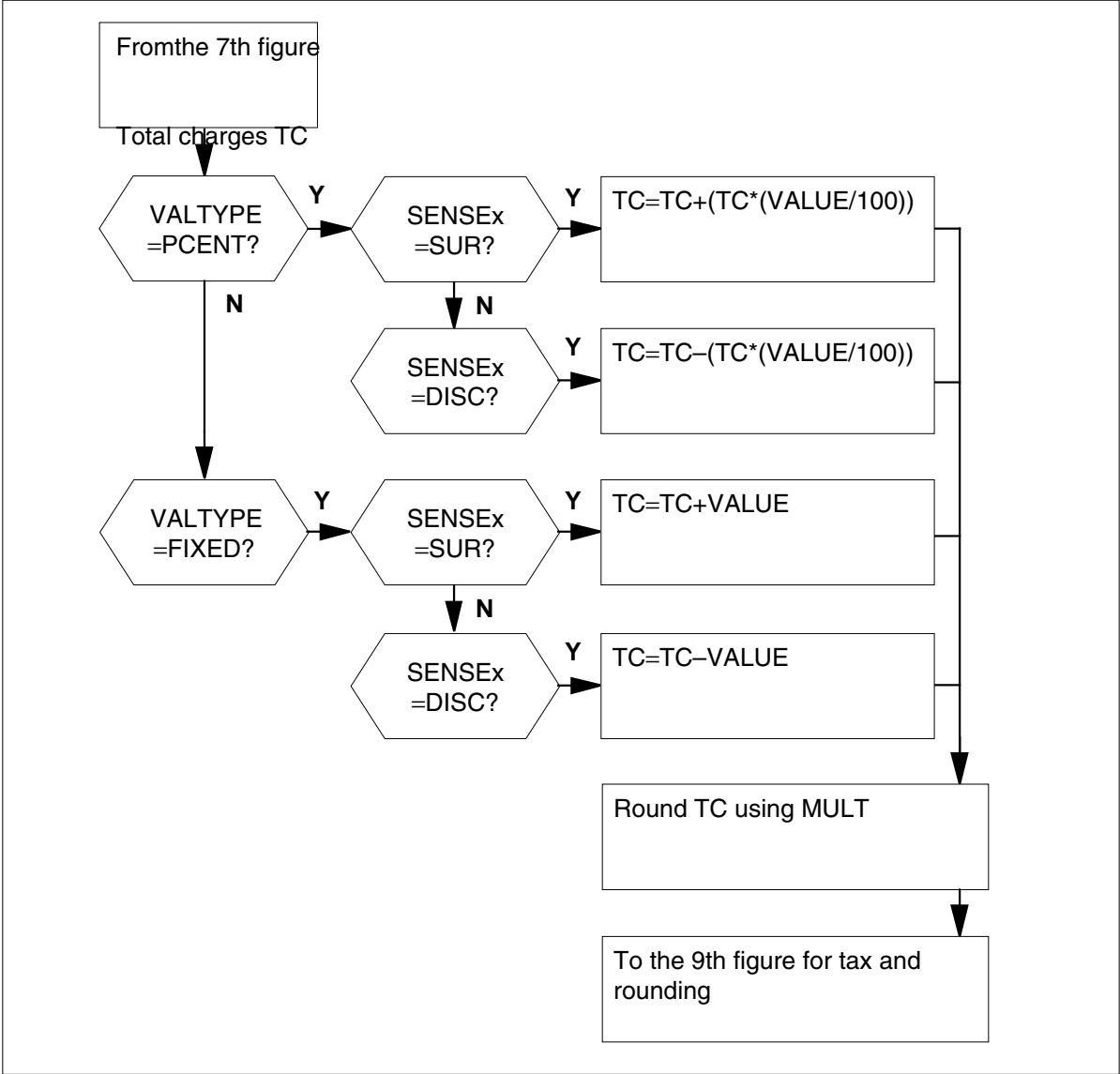

ATRIMOD (continued)

ITOPS rating system flowchart : Determination of tax and rounding fields

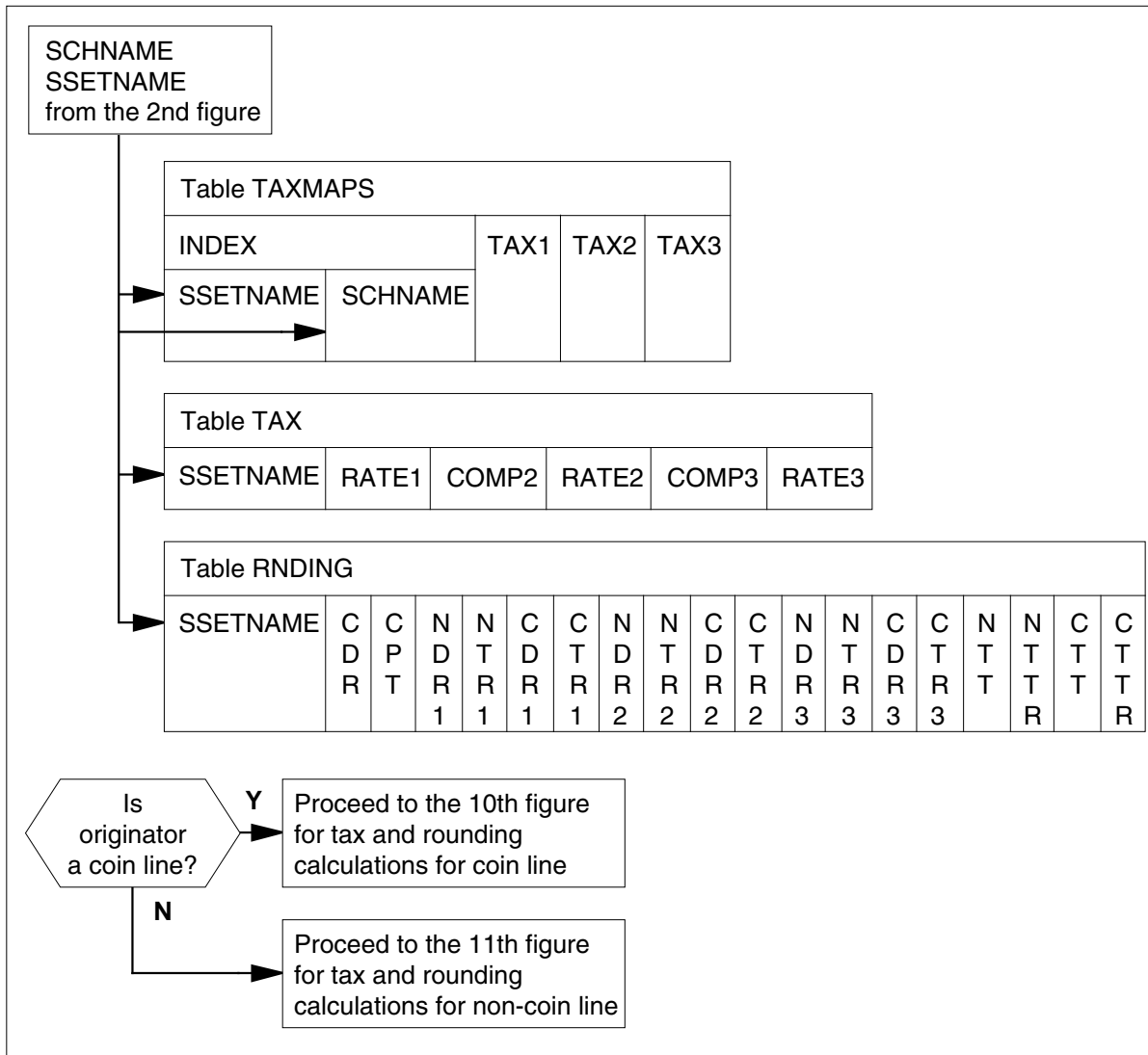

ATrimOD (continued)

ITOPS rating system flowchart : Calculation of taxes and rounding for coin lines

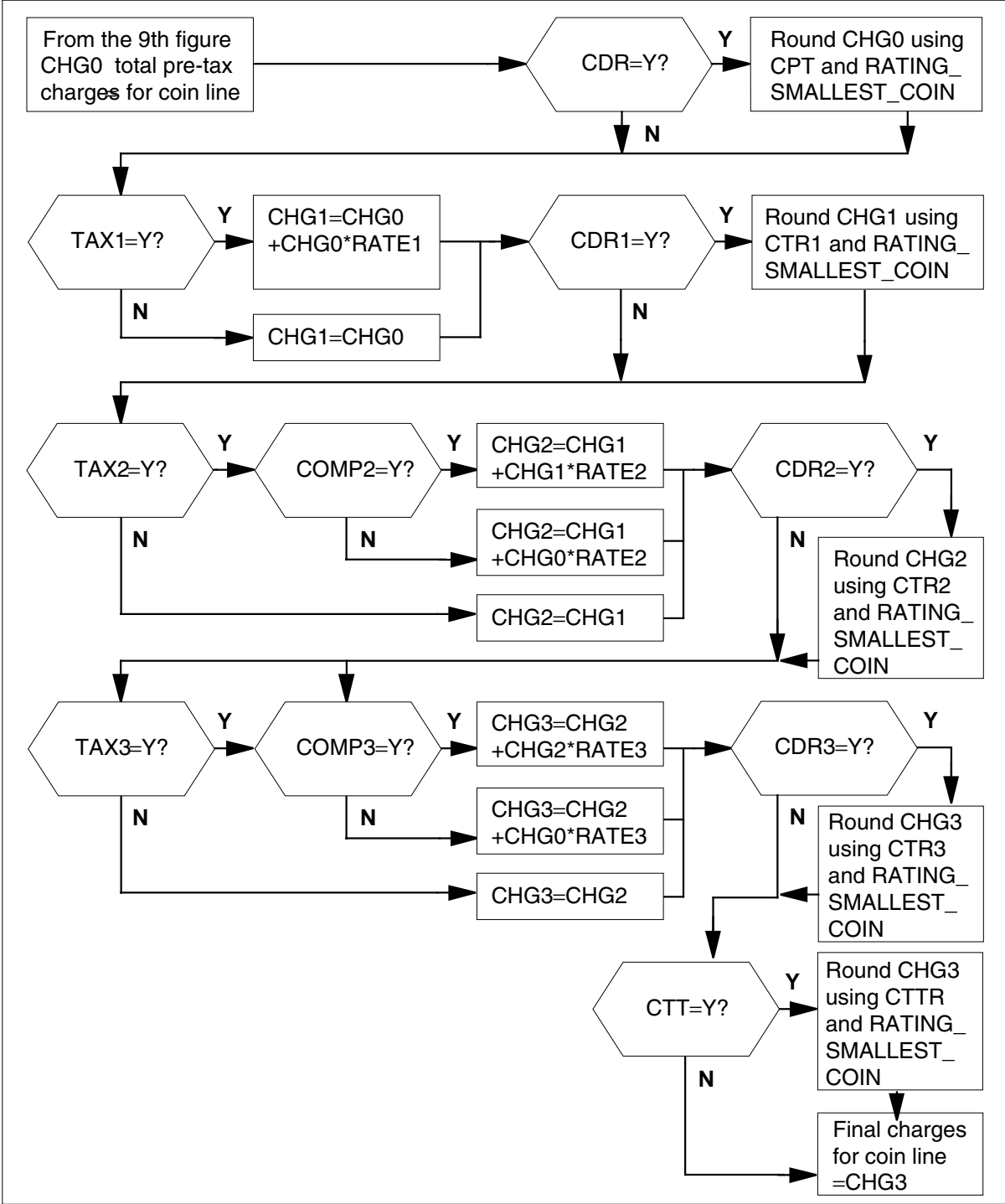

ATRIMOD (continued)

ITOPS rating system flowchart : Calculation of taxes and rounding for noncoin lines

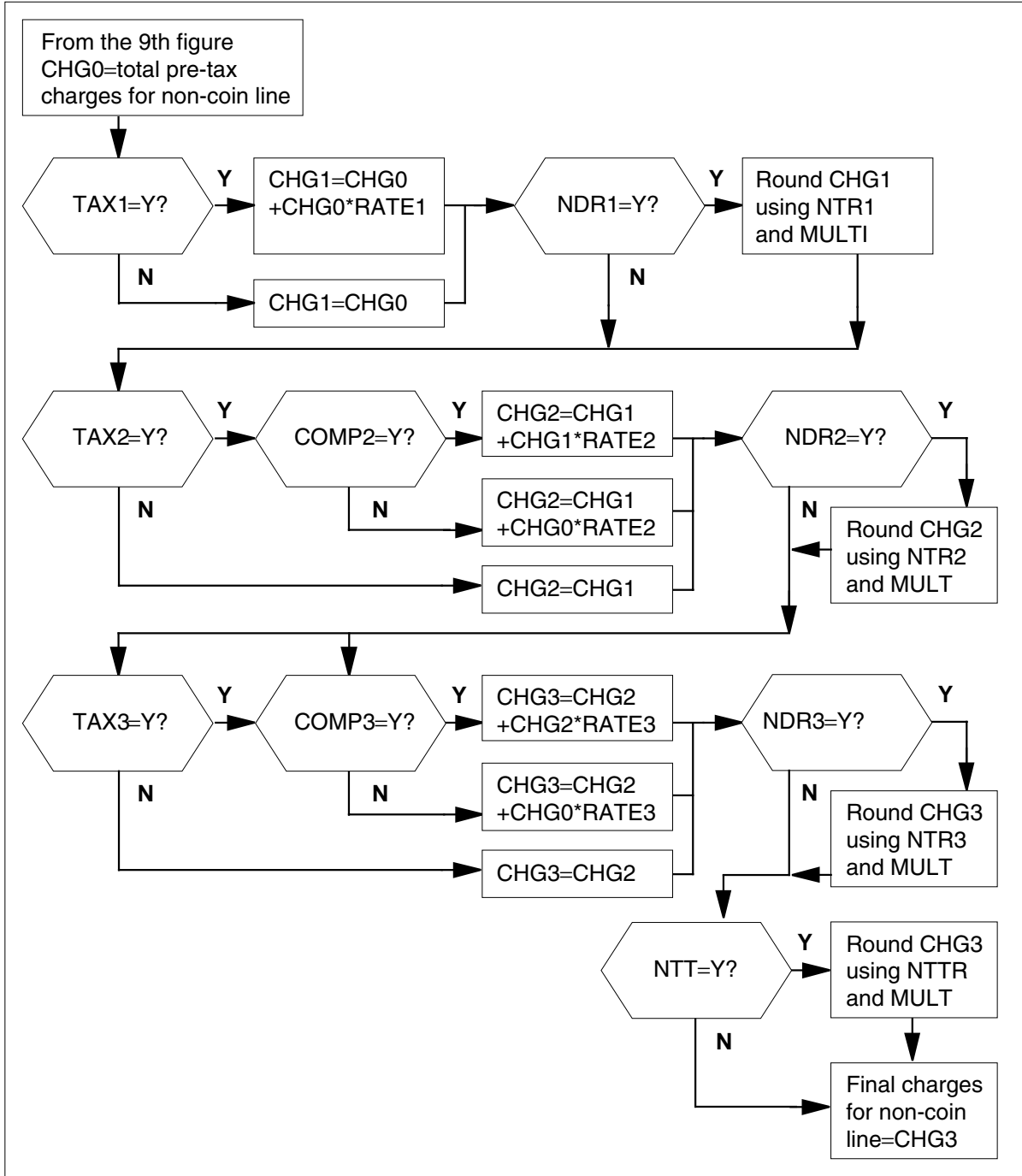

Datafill sequence and implications

Table ATTRIB must be datafilled before table ATRIMOD.

ATRIMOD (continued)**Table size**

0 to 128 tuples

Activation

Table TOPSPARM parameter NUMBERING_PLAN must be set to OPEN_NUMBERING.

Datafill

The following table lists datafill for table ATRIMOD.

Field descriptions

Field	Subfield or refinement	Entry	Explanation and action
INDEX		see subfields	Key into table ATRIMOD. The key into table ATRIMOD consists of subfields SCHNAME and ATTRIB.
	SCHNAME	alphanumeric (string of 1 to 16 characters)	Schedule name. Enter the name of the schedule that is listed in table SCHNAME.
	ATTRIB	1 to 255	Attribute number. Enter the attribute number. During automatic charge calculations the attribute number used to index into this table is found in field INDEX of table ATTRIB from the tuple found to match the call characteristics (origination type and attribute set).
SENSEPER		SUR or DISC	Sense percent. Values are for percent surcharge (SUR) and percent discount (DISC). Default is SUR.
PERCENT		0-1000	Percent. Range is 0-1000 when field SENSEPER=SUR, or 0-100 when SENSEPER=DISC. Default is 0.
SENSEFIX		SUR or DISC	Sense fixed. Values are for a fixed surcharge amount (SUR) and a fixed discount amount (DISC). Default is SUR.
FIXED		0-32767	Fixed amount. Range is valid when field SENSEFIX is SUR or DISC. Default is 0.

ATRIMOD (end)

Datafill example

The following example shows sample datafill for table ATRIMOD.

MAP display example for table ATRIMOD

SCHNAME	ATTRIB	SENSEPER	PERCENT	SENSEFIX	FIXED
SCHCLGONAT	4	SUR	50	DISC	10
SCHCLGoloc	3	SUR	400	SUR	10

Table history

TOPS03

Fields SENSE, VALTYP, and VALUE are changed to fields SENSEPER, PERCENT, SENSEFIX, and FIXED per feature AN1085 in GOS Enhancements, GOS00001.

BCS36

VALUE options changed to reflect new subfields

ATTCONS

Table name

Attendant Console Table

Functional description

Table ATTCONS is required for a switching unit that is equipped with the Integrated Business Network (IBN) feature and if one or more of the customer groups are equipped with attendant consoles.

A maximum of 255 attendant consoles are permitted by the switching unit data structures.

The 255 attendant consoles can serve one very large customer group or one or more can be assigned for each customer group.

The attendant console has a line module interface using three tip and ring pairs onto three standard line cards, one for voice, one for transmitting keyboard information from the attendant console to the switch, and one for attendant console to receive information from the switch. The line cards can be located at a host or a remote switching unit.

It is recommended that the three line cards assigned to an attendant console be assigned to the same line drawer on the same line module.

Datafill sequence and implications

The following tables must be datafilled before table ATTCONS:

- IBNLINES
- WCKCODES
- OFCOPT
- FNMAP
- NCOS
- ODCENG
- SUBGRP
- ACLANG
- TRIGGRP

The following office parameters have direct interaction with table ATTCONS:

- NO_OF_SMDR_REC_UNITS in table OFCENG
- SMDR_OFFICE in table OFCOPT

ATTCONS (continued)

- USINGSITE in table OFCOPT
- UNIQUE_BY_SITE_NUMBERING in table OFCENG

Table size

0 to 256 tuples

It is recommended that the value of parameter MAXNUCS in table OFCENG be increased by the number of attendant consoles X 3.

Memory is automatically allocated for the maximum number of attendant consoles, 255.

Datafill

The following table lists datafill for table ATTCONS.

Field descriptions (Sheet 1 of 4)

Field	Subfield or refinement	Entry	Explanation and action
CONSOLE		alphanumeric (1 to 16 characters)	<i>Console</i> Enter the common language location identifier (CLLI) assigned to the console.
CUSTNAME		alphanumeric (1 to 16 characters)	<i>Customer group name</i> Enter the name of the customer group that is assigned in both table CUSTCONS and in table CUSTHEAD with field CONSOLES set to Y.
SUBGRP		0 to 7	<i>Subgroup</i> Enter the number of the attendant subgroup to which the console is assigned.
NCOS		0 to 511	<i>Network class of service</i> Enter the network class of service (NCOS) number assigned to the attendant console.
CDR		Y or N	<i>Call detail record</i> Enter Y (yes) if all calls originating from the attendant console are recorded in the station message detail recording (SMDR) format. Otherwise, enter N (no).

ATTCONS (continued)

Field descriptions (Sheet 2 of 4)

Field	Subfield or refinement	Entry	Explanation and action
CARDCODE		4X08AA 4X08ABor4X 08BA	<i>Card code</i> Enter the product engineering code (PEC) of the card that identifies the type of hardware contained in the console. 4X08AA is for receiving data at 300 baud, 4X08AB is for receiving data at 1200 baud, and 4X08BA is for receiving data at 300 baud using A-law pulse code modulation (PCM) format.
INLEN		see subfields	<i>Incoming to switch line card</i> This field defines the physical location of the equipment that is connected to a specific telephone line. Because field LEN is common to more than 60 tables, it is documented in a single section to avoid unnecessary duplication. Refer to section "Common entry field LEN" for a complete description of field LEN and associated subfields. Field LEN consists of subfields SITE, FRAME, UNIT, DRAWER or LSG, SHELF, SLOT, and CIRCUIT.
OUTLEN		numeric	<i>Outgoing from switch line card</i> Enter the line equipment number (LEN) of the line card to which signal line from switch to console is assigned. This field consists of subfields: SITE, FRAME, UNIT, DRAWER OR LSG SHELF, SLOT, and CIRCUIT. See the appropriate subfield name described for INLEN.
TALKLEN		numeric	<i>Talking circuit line card</i> Enter the line equipment number (LEN) of the line card to which talking line from console is assigned. This field consists of subfields SITE, FRAME, UNIT, DRAWER OR LSG and CIRCUIT. See the appropriate subfield name described for INLEN.

ATTCONS (continued)

Field descriptions (Sheet 3 of 4)

Field	Subfield or refinement	Entry	Explanation and action
INSV		Y or N	<p><i>In service</i></p> <p>Enter Y (yes) for consoles that are brought into service over cold SWACTs or restarts. This allows the user to specify which consoles are brought into service even if the console was offline initially.</p> <p>Enter N (no) for consoles that are not brought into service over cold switch of activity (SWACT) or restarts.</p> <p>During a NORESTARTSWACT or MTCSWACT, existing calls to an Attendant Console will be dropped. All consoles with INSV set to Y in table ATTCONS will be returned to service (RTS) after the NORESTARTSWACT or MTCSWACT. The console will be in night service after the RTS.</p>
OPTION		AIN BUZZ LANG SUP VPNACID or blank	<p><i>Console options</i></p> <p>This field consists of a list of options and in some cases an additional field to further refine the option.</p> <p>Enter AIN to allow an AIN group (AINGRP) name to be datafilled for the attendant console. The only AIN service supported for attendant consoles is SCP based VPN. It is not necessary to datafill VPNACID if AIN is datafilled.</p>

ATTCONS (continued)

Field descriptions (Sheet 4 of 4)

Field	Subfield or refinement	Entry	Explanation and action
OPTION (continued)			<p>Enter BUZZ followed a blank space, followed by one of the following refinements:</p> <ul style="list-style-type: none"> • SHORT (sends a short buzz message to the console) • TONE (sends no buzz message to the console but sends an alert tone to the headset) • BOTH (sends a buzz message to the console and an alert tone to the headset) • LONG (sends repeated timed buzz messages to the console but no alert tone to the headset) <p>Note: If BUZZ is not entered, the default is SHORT, but this does not show as an option in the table.</p> <p>Enter LANG to define the default display language of the console followed by a blank space, followed by any one of the languages defined in table ACLANG. If the default language is English, this option need not be specified.</p> <p>Note: The entry following the option must be separated from the option by at least one blank space.</p> <p>Enter SUP to suppress SMDR records for FLASH and FLASHOVERRIDE precedence type calls in an IBN environment.</p>
OPTION (continued)			<p>Enter VPNACID to allow a unique attendant console identifier (ACID) to be datafilled. If VPNACID is datafilled, the AIN option must also be datafilled.</p> <p>If no options are assigned to the console, leave the field blank.</p>

ATTCONS (continued)**OPTION = AIN**

If the value of field OPTION is AIN, datafill refinement AINGRP.

Field descriptions for conditional datafill

Field	Subfield or refinement	Entry	Explanation and action
	AINGRP	alphanumeric (1 to 16 characters)	<i>AIN Goup</i> Enter the AIN group name. The AINGRP name must already exist in table TRIGGRP before it can be datafilled in table ATTCONS.

OPTION = VPNACID

If the value of field OPTION is VPNACID, datafill refinement ACID.

Field descriptions for conditional datafill

Field	Subfield or refinement	Entry	Explanation and action
	ACID	0 to 255	<i>ACID</i> Enter the unique attendant console identifier.

Datafill example

The following example shows sample datafill for table ATTCONS.:

The example consists of

- one attendant console with a CLLI code of ATTGOCA, which belongs to a customer group with a CUSTNAME of COMKODAK
- the attendant console is assigned to subgroup zero
- the attendant console is assigned NCOS number 5
- a record of all calls originating from the attendant console in the SMDR format is required
- the console has a card code of 4X08AA
- the three line cards for the attendant console are located on line module frame number 2, bay 0, and line drawer 4 at the host switching unit
- the console is brought into service over cold SWACTs or restarts
- the alerting signal to the console is a short buzz
- the default language of the console is French

ATTCONS (continued)**MAP display example for table ATTCONS**

CONSOLE	CUSTNAME	NCOS	CDR	CARDCODE
INSV	SUBGRP	OUTLEN		TALKLEN
INLEN				OPTIONS
ATTGOCA				
	COMKODAK			
	0	5	Y	4X08AA
HOST 02 0 04 02	HOST 02 0 04 03		HOST 02 0 04 04	
Y				
		(BUZZ SHORT)	(LANG FRENCH)	\$

Table history**AP03**

Added refinement AINGRP for option AIN and refinement ACID for option VPNACID. Removed options VPNBGID, VPNSITE, and refinements BGID and SITE.

BCS36

Added options AIN, VPNACID, VPNBGID, and VPNSITE.

BCS35

Added error message about attendant console.

Supplementary information

This section provides information on datafilling table ATTCONS for specific applications, and product descriptive information related to table ATTCONS.

Line assignments

For line assignments of the attendant console line cards, see table IBNLINES.

The user can have a number of locations within a city all served by the same switching unit. The user can centralize attendant service on a full- or part-time basis for these locations. To permit centralization of attendants on a part time basis only, each of the attendant consoles are assigned to subgroups.

If a user requires centralized operation on a full-time basis, all attendant consoles for the customer group must belong to subgroup 0.

ATTCONS (continued)

The switching unit data structure supports a maximum of eight subgroups for each customer group.

The attendant console subgroup data is assigned in table SUBGRP.

Feature keys

Each console is equipped with 42 assignable feature keys and associated lamps.

To conserve the 42 keys and lamps on the attendant console, the operating company may use the additional wild card (WC) key to invoke special features not directly available on the console through a feature key. Any of the features defined in table FNMAP, excluding incoming call identification codes (ICIs) can be assigned to the wild card key. The assignment of features to the wild card key are defined in table WCKCODES.

Only the first two feature keys are dedicated in function to night service and console test respectively. The remaining 42 feature keys and associated lamps can be assigned to any feature that the switching unit logic supports.

If the customer group has more than one attendant console, the feature keys on each console can be assigned flexibly.

The attendant console feature keys and associated lamps are assigned in table FNMAP.

The key lamp display (KLD) is a non-optional extension of the attendant console and field KLD in table ATTCONS is deleted.

The console is set up to receive data at 300 or 1200 baud, depending on the type of card. Cardcode 4X08AA receives data at 300 baud, cardcode 4X08AB receives data at 1200 baud, and cardcode 4X08BA receives data at 300 baud using A-law PCM format.

The user can specify which consoles to bring into service over a cold switch of activity (SWACT) or restart.

Network class of service

The network class of service (NCOS) number and the customer group NAME are indexes into table NCOS.

The network class of service (NCOS) number defines the NCOS name, line screening codes, and NCOS options applicable to the console.

ATTCONS (continued)

Station message detail recording

Only calls originating from the attendant console can be recorded in the station message detail recording (SMDR) format in a switching unit that has the option SMDR_OFFICE set to Y (yes) in table OFCOPT.

If option SMDR_OFFICE is set to Y, it affects the value of office parameter NO_OF_SMDR_REC_UNITS in table OFCENG.

Options

Field OPTIONS consists of a list of options (features) accessible to the attendant console. These options are described below.

AIN

Option AIN allows an AIN group name to be entered. Since the only AIN service supported for attendant consoles is SCP based VPN, the VPN options must be datafilled if the AIN option is datafilled.

BUZZ

Option BUZZ allows from one to four alerting tones for the console.

To change the console buzz mode by table control, the console must be force-released prior to the change in table ATTCONS. The console is then returned to service and the new value takes effect. This new value takes effect on a cold or a reload restart.

If the attendant controls the mode of console buzzing, the BUZZ feature must be assigned to one of the 42 keys on the console or to the wild card key.

LANG

Option LANG changes the default display language of a console to a language other than English. After option LANG, a language name, defined in table ACLANG, must be entered to define the default language of the console.

If a console defaults to English messages, this option need not be specified. The attendant can still change the operating language of the console if a feature key or wildcard code is assigned to the feature.

If a console is not provided with a feature or wildcard code, the operating language can be changed only by changing the default language in table ATTCONS. This requires removing the console from service, changing the LANG option, and then returning the console to service. Deleting the language option changes the default language back to English.

ATTCONS (end)

SUP

Option SUP allows for SMDR records to be suppressed for FLASH and FLASH OVERRIDED precedence type calls in an IBN environment. All SMDR records are suppressed for both originators and terminators.

VPN options

The VPN options indicate if an attendant console is part of a VPN. The AIN option must be datafilled in conjunction with the VPN options. The options VPNACID, VPNBGID, and VPNSITE must be datafilled as a group, and are referred to collectively as VPN options. The unique attendant console identifier is supplied with the VPNACID option. The VPN business group is supplied with the VPNBGID option. The VPN site identifier is supplied with the VPNSITE option.

Warning message

If the user adds or deletes a remote fiber terminal (RFT) tuple in table ATTCONS, and the attendant console static data has not been sent to the subscriber carrier module (SMA), the following warning message is displayed at the MAP:

```
ATTENDANT CONSOLE DATA HAS NOT BEEN UPDATED IN THE PERIPHERAL
```

This can happen if the EOC is down or if the line provisioning data has not been completed by the RFT. There is no corrective action that the user can take. The static data mismatch is cleared by an audit.

ATTOPTNS

Table name

Automatic Trunk Test Sequence Option Table

Functional description

Table ATTOPTNS contains automatic trunk test control data that does not correspond to specific trunk groups.

All automatic trunk tests are classified into one of following test classes:

- ATME No. 2 (ATME or ATME1 - used by DMS-300 gateway switching units)
- manual (MAN, MAN1, MAN2, MAN3, or MAN4 - entered from automatic trunk test level of MAP)
- nonstandard (NSTD)
- periodic (PERD or PERD1)
- quarterly (QUAR)
- semi-yearly (SYR)

All tests from the automatic trunk test group schedule table (ATTSCHEDED) use table ATTOPTNS.

Table ATTOPTNS lists the following data for each of the test classes:

- the type of logging exercised for the following transmission type tests: MXAM, MXAN, MXRM, MXRN, MXWM, MXWN, N100, S100, S104, TART, TA01, TA02, TA03, TA04, TA05, TA07, TA08, TA09, TA10, TA11, TA14, TA15, TA16, TA17, TA18, TA20, TA21, TA22, TA23, TA24, TB08, TB18, TERL, TLPA, TLPB, TL0N, TL0S, TL05, TL6N, TL6S, TL65, TSBT, T100, T102, T104, T105, T165, T5AS, T5AT, T5BS, T5LB, T5LH, T50L, T56N
- the type of logging exercised for the following operational type tests: DIAG, TA06, TA07, TA08, TA09, TA10, TA11, TA12, TA13, TA14, TA15, TA16, TA17, TA18, TA19, TA20, TA21, TA22, TA23, TA24, TA25, TE_M, TNSS, TR2L, TR2S, TSBS, TSYN, TS05, TS65, T103, T5SB
- the maintenance and immediate action loss limits in 0.1-dB increments (0 to 9.9 dB) for different frequencies

Note: The standard values for maintenance and immediate action loss limits are 1.7 dB and 3.7 dB, respectively.

ATTOPTNS (continued)

- the minimum amount of time in minutes (0 to 7) to wait for busy trunks to become available for test
- a set of failures for which a retest is made if the type of test is ATME No. 2
- whether a trunk that has failed a test is to be retested
- whether an attempt is to be made to remove trunks from service if they fail a test

Note: Trunks removed from service are set to a manual busy state

- the maximum percentage of a trunk group that can be removed from service for automatic trunk test purposes (that is, 25% or 50%)

For the ATME tests that fall into both operational and transmission classes, a log is generated if either of the criteria is satisfied.

Note: For ATME tests (TA01-TA25), tables D3MAINTD and ATMEQ specify the maintenance and immediate action limits used for loss measurements, but table ATTOPTNS must be datafilled with default values to satisfy table control. The entry in field NMLTA is not used for ATME, but must be datafilled to satisfy table control.

Datafill sequence and implications

There is no requirement to datafill other tables prior to table ATTOPTNS.

Table size

0 to 12 tuples

ATTOPTNS (continued)**Datafill**

The following table lists datafill for table ATTOPTNS.

Field descriptions (Sheet 1 of 4)

Field	Subfield or refinement	Entry	Explanation and action
TSTCLASS		ATMEATME1 MANMAN1M AN2MAN3MA N4NSTDPER DPERD1QUA RSYR	<p>Test class name</p> <p>Enter one of the following test class names:</p> <ul style="list-style-type: none"> • ATME, ATME1 (ATME No. 2) • MAN, MAN1, MAN2, MAN3, MAN4 (manual) • NSTD (nonstandard) • PERD, PERD1 (periodic) • QUAR (quarterly) • SYR (semi-yearly)
TRNSMOUT		ALLTRALLTR FLQ1TQ2T	<p>Transmission outputs</p> <p>Enter the type of logging that is required for transmission tests:</p> <ul style="list-style-type: none"> • ALLTR (log all trunks, including passes and those that exceed the maintenance or immediate action noise limits) • ALLTRFL (log only transmission failures) • Q1T (log only trunks that exceed the maintenance or immediate action noise limits) • Q2T (log only the trunks that exceed the immediate action noise limits)
OPEROUT		ALLOP FAILOP	<p>Operational outputs</p> <p>Enter the type of logging required for operational tests:</p> <ul style="list-style-type: none"> • ALLOP (log all trunks, including passes) • FAILOP (log only the trunks that fail operational tests)
Q1LIMIT		numeric(0 to 99)	<p><i>Transmission maintenance test limit</i></p> <p>Enter the transmission maintenance test limit in 0.1-dB increments (0 to 9.9 dB).</p> <p>The standard value is 1.7 dB.</p>

ATTOPTNS (continued)

Field descriptions (Sheet 2 of 4)

Field	Subfield or refinement	Entry	Explanation and action
Q2LIMIT		numeric(0 to 99)	<i>Transmission immediate action test limit</i> Enter the transmission immediate action test limit in 0.1-dB increments (0 to 9.9 dB). The standard value is 3.7 dB.
Q1L404		numeric(0 to 99)	<i>Transmission maintenance test limit</i> Enter the transmission maintenance test limit in 0.1-dB increments (0 to 9.9 dB) for loss measurements at -16 dB and 404 Hz.
Q2L404		numeric(0 to 99)	<i>Transmission immediate action test limit</i> Enter the transmission immediate action test limit in 0.1-dB increments (0 to 9.9 dB) for loss measurements at -16 dB and 404 Hz.
Q1L1004		numeric(0 to 99)	<i>Transmission maintenance test limit</i> Enter the transmission maintenance test limit in 0.1-dB increments (0 to 9.9 dB) for loss measurements at -16 dB and 1004 Hz.
Q2L1004		numeric(0 to 99)	<i>Transmission immediate action test limit</i> Enter the transmission immediate action test limit in 0.1-dB increments (0 to 9.9 dB) for loss measurements at -16 dB and 1004 Hz.
Q1L2804		numeric(0 to 99)	<i>Transmission maintenance test limit</i> Enter the transmission maintenance test limit in 0.1-dB increments (0 to 9.9 dB) for loss measurements at -16 dB and 2804 Hz.
Q2L2804		numeric(0 to 99)	<i>Transmission immediate action test limit</i> Enter the transmission maintenance test limit in 0.1-dB increments (0 to 9.9 dB) for loss measurements at -16 dB and 2804 Hz.
NMLTA		numeric(0 to 99)	<i>Noise maintenance and immediate action limit correction</i> Enter the value for the noise maintenance and immediate action limits in 1-dBrn increments (0 to 99 dBrn) for noise with tone measurement (C-notched filter).

ATTOPTNS (continued)

Field descriptions (Sheet 3 of 4)

Field	Subfield or refinement	Entry	Explanation and action
WAITTIME		numeric(0 to 7)	<i>Wait time</i> Enter the length of time (in minutes) to wait for busy trunks to become available for testing when testing is suspended because no trunks are available.
RETSTSET		ALL, BSY_FE, BSY_FLAS-SH _FAIL, BSY_NE, INST_INTER, MEAS_Q-1_F AIL, MEAS_Q-2_F AIL, MISC_FAIL,N ONE, SIG_FAIL, or TSTPASS	<i>Retest set</i> If the test class name is ATME and the entry in field RETEST is Y (yes), the retest is only done if the reason for failure is found in this set. Otherwise, the retest is not done. Enter one or more reasons for failure. Each reason for failure must be separated from the other by a blank column. If the set is continued on the next record, enter + preceded by a blank column and enter the next member of the set on the next record. If the set of reasons is complete, enter \$ preceded by a blank column to indicate the end of the set. Enter ALL, not followed by \$, if there is no restriction on the reasons for failure. If the test class name is not ATME, enter ALL to satisfy table control.

ATTOPTNS (continued)

Field descriptions (Sheet 4 of 4)

Field	Subfield or refinement	Entry	Explanation and action
RETSTSET (continued)			<p>The reason for failures are as follows:</p> <ul style="list-style-type: none"> • SIG_FAIL (signaling failure) • BSY_FLASH_FAIL (busy flash test failure) • MEAS_Q1_FAIL (transmission exceeded Q1) • MEAS_Q2_FAIL (transmission exceeded Q2) • BSY_NE (near end busy) • BSY_FE (far end busy) • INST_INTER (interim instability) • MISC_FAIL (miscellaneous failures) • TSTPASS (causes ATT to perform a retest after a pass) • NONE (invalid entry)
RETEST		Y or N	<p><i>Retest on failure</i> If a circuit is retested on a test failure, enter Y. Otherwise enter N (no).</p>
REMOVE		Y or N	<p><i>Remove from service</i> If a circuit is removed from service on a test failure, enter Y. Otherwise enter N.</p>
RMV25PC		Y or N	<p><i>Remove from service check</i> If the maximum percentage of trunks that can be removed from service is 50%, enter N. If the maximum percentage of trunks that can be removed from service is 25%, enter Y.</p>
MQIDX		numeric (0 to 9)	<p><i>Maintenance Q index</i> Enter the index into table MQLIMITS where the BERTL Q limits are stored.</p>

Datafill example

A sample of example datafill for table ATTOPTNS on a local/toll switch is shown below.

ATTOPTNS (continued)

This example is datafilled in accordance with the following requirements.

- a periodic sequence that logs all transmission tests that exceed maintenance limits and that fail operational tests
- a transmission maintenance test limit of 1.7 dB and immediate action test limit of 3.7 dB
- a wait time of 1 min for busy trunks
- trunks are retested and removed from service on test failures, regardless of the type of failure
- the maximum percentage of trunks that can be removed from service is 50%

MAP display example for table ATTOPTNS

TSTCLASS	TRNSMOUT	OPEROUT	Q1LIMIT	Q2LIMIT	Q1L404
Q2L404	Q1L1004	Q2L1004			
Q1L2804	Q2L2804	NMLTA	WAITTIME	RETSTSET	RETEST
REMOVE	RMV25PC	MQIDX			
PERD	Q1T	FAILOP			
17	37	17	37	37	17
37	17	37	17	1	ALL
Y	Y	N	0		

A sample of example datafill for table ATTOPTNS on a gateway switch is shown below.

This example is datafilled in accordance with the following requirements.

- an ATME No. 2 sequence that logs all transmission tests that exceed maintenance limits and that fail operational tests
- the transmission maintenance test limits and immediate action test limits are default datafilled with a value of 0 (zero) since the actual values are present in table ATMEQ
- a wait time of 1 min for busy trunks
- trunks are retested and removed from service on test failures regardless of the type of failure
- the maximum percentage of trunks that can be removed from service is 50%

ATTRIB

Table name

ITOPS Rating Charge Calculator Attribute

Functional description

Table ATTRIB maps an attribute number to a unique combination of

- call origination types:
 - OA (Operator assisted)
 - OH (Operator handled)
 - DD (Direct dialed)
 - INTERCEPT
 - INWARD
 - BOOK
 - SPECIAL
 - DATABASE
 - OPER
- a set of 0 or more of the following attributes:
 - COIN (Coin paid)
 - HOTEL (Hotel paid)
 - TAC (Time and charges)
 - DB (Database call)
 - APS (Attendant pay station)
 - PER (Person to person)
 - COL (Bill to called party [collect])
 - PCB (Bill as person call back)
 - CC (Calling card)
 - BILL3RD (Bill to third)
 - NM (No call charge modification)
 - M1 to M8 (Call charge modification set 1 to 8)

Table ATTRIB is used when table CHGHEAD field ATTRIB = Y, for the incoming schedule name and ratestep, indicating that the default charge rates in table CHGHEAD may be superseded for calls having specified characteristics.

ATTRIB (continued)

When a match for the call characteristics is not found in table ATTRIB, the default charge rates of table CHGHEAD apply.

When there is a match for the call characteristics in table ATTRIB, the entry found in field INDEX of table ATTRIB is then used to index tables CHGATRIB and ATRIMOD, which define call-characteristic-dependent charge and discount or surcharge rates.

When call-characteristic-dependent charge and discount or surcharge rates apply, the system calculates the charges using tables ATTRIB, CHGATRIB and ATRIMOD, superseding default charge rates of table CHGHEAD, and then proceeds to calculate the date- and time-dependent discount or surcharge, starting with table TIMEZONE.

Datafill sequence and implications

There is no requirement to datafill other tables prior to table ATTRIB.

The following tables must be datafilled after table ATTRIB:

- ATRIMOD
- ATRIMODI
- CHGATRIB
- CHGATRIBI

Table size

0 to 128 tuples

ATTRIB (continued)

Datafill

The following table lists datafill for table ATTRIB.

Field descriptions (Sheet 1 of 2)

Field	Subfield or refinement	Entry	Explanation and action
INDEX		0 to 255	Attribute number. Enter the attribute number.

ATTRIB (continued)

Field descriptions (Sheet 2 of 2)

Field	Subfield or refinement	Entry	Explanation and action
ORIG		BOOK, DA, DD, ESTIMATE, INTERCEPT, INWARD, OA, OH, OPER, SPECIAL, or UNSPECIFIED	Call origination type. Enter the call origination type.
ATTRIB		APS, BILL3RD, CC, COIN, COL, DB, HOTEL, M1, M2, M3, M4, M5, M6, M7, M8, NM, PER, PCB, TAC	<p>Call attribute set. Leave blank or enter one or more call attributes separated by at least one blank.</p> <p>Current attributes are as follows:</p> <ul style="list-style-type: none"> • COIN (Coin paid) • HOTEL (Hotel paid) • TAC (Time and charges) • DB (Database call) • APS (Attendant pay station) • PER (Person to person) • COL (Bill to called party [collect]) • PCB (Bill as person call back) • CC (Calling card) • BILL3RD (Bill to third of 13) • NM (No call charge modification of 13) • M1 (Call charge modification set #1) • M2 (Call charge modification set #2) • M3 (Call charge modification set #3) • M4 (Call charge modification set #4) • M5 (Call charge modification set #5) • M6 (Call charge modification set #6) • M7 (Call charge modification set #7) • M8 (Call charge modification set #8)

Datafill example

The following example shows sample datafill for table ATTRIB.

MAP display example for table ATTRIB

INDEX	ORIG	ATTRIB
1	OA	DB CC
2	OH	COIN
3	INWARD	
4	OA	
5	OA	DB M1 M8

ATTSCHEDED

Table name

Automatic Trunk Test Group Schedule Table

Functional description

Table ATTSCHEDED lists the following data for each outgoing or two way trunk group that requires automatic trunk testing:

- the common language location identifier (CLLI) of the trunk group for which testing is required
- the name of the required test
- whether testing is required for the specified trunk group
- the frequency and time at which testing is to take place
- the maximum test duration time
- the length of time for the far end to drop in a test line
- the automatic trunk test sequence

Automatic trunk tests that are supported by table ATTSCHEDED are listed in table Automatic trunk tests.

Automatic trunk tests (Sheet 1 of 5)

Test	Applicability	Test description
DIAG	operational	diagnostic circuit check
MXAM	transmission	audio loop test for far-to-near and near-to-far noise measurements: loop loss measurements are performed using a 0-dB 1004-Hz tone, noise measurements are made with a C-message filter
MXAN	transmission	wire loop test for far-to-near and near-to-far noise measurements: loop loss measurements are performed using a -16-dB 1004-Hz tone, noise measurements are made with a C-notch filter

ATTSCHEID (continued)**Automatic trunk tests (Sheet 2 of 5)**

Test	Applicability	Test description
MXRM	transmission	Radio frequency (RF) loop test for far-to-near and near-to-far loss and noise measurements: loss measurements are performed using a 0-dB 1004-Hz tone, noise measurements are made with a C-message filter
MXRN	transmission	RF loop test for far-to-near and near-to-far loss and noise measurements: loss measurements are performed using a -16-dB 1004-Hz tone, noise measurements are made with a C-notch filter
MXWM	transmission	wire loop test for far-to-near and near-to-far loss and noise measurements: loss measurements are performed using a 0-dB 1004-Hz tone, noise measurements are made with a C-message filter
MXWN	transmission	wire loop test for far-to-near and near-to-far loss and noise measurements: loss measurements are performed using a -16-dB 1004-Hz tone, noise measurements are made with a C-notch filter
N100	transmission	balance and milliwatt test: far-to-near loss and noise measurement
S100	transmission	balance line test: far-to-near noise measurement
TART	transmission	loss and noise measurement for Turkish trunks (not designed for use with North American trunks)
TA01	transmission	DMS-300 Gateway automatic transmission and signaling tests.
TB08	transmission	bit error rate line test at a speed of 56 kbit/s

ATTSCHEDED (continued)**Automatic trunk tests (Sheet 3 of 5)**

Test	Applicability	Test description
TB18	transmission	bit error rate line test at a speed of 64 kbit/s (this speed is only used on trunk facilities that are capable of transmitting at this speed - for example, Common Channel Signaling 7 (CCS7) trunks.
TE_M	operational	test of E and M signaling leads between trunk equipment and a signaling unit: the M lead transmits ground or battery conditions, while the E lead receives open or ground signals
TERL	transmission	105 originating line test: measurement of echo return loss
TLPA	transmission	loop-around test: measurement of loss in both directions
TL0N	transmission	105 originating test line: noise measurement and loss measurement at 0 dB and 1004 Hz.
TL0S	transmission	105 originating test line: loss measurement with self-check at 1004 Hz and 0 dB
TL01	transmission	digital loop-around test for CCITT CCS7 ISDN user part (ISUP) trunks on DMS-300 gateway switching units: used for accessing the digital loop-around test line at the far end switching unit for loss and noise measurements in both directions
TL05	transmission	105 originating test line: loss measurement at 1004 Hz and 0 dB
TL6N	transmission	105 originating test line: loss measurement at 404 Hz, 1004 Hz, and 2804 Hz at -16 dB and noise measurement with tone

ATTSCHEID (continued)**Automatic trunk tests (Sheet 4 of 5)**

Test	Applicability	Test description
TL6S	transmission	105 originating test line: loss measurement with self-check at 404 Hz, 1004 Hz, and 2804 Hz at -16 dB
TL65	transmission	105 originating test line: loss measurement at 404 Hz, 1004 Hz, and 2804 Hz at -16 dB
TNSS	operational	non-synchronous test
TR2L	operational	repeat two (long delay) test
TR2S	operational	repeat two (short delay) test
TSBS	operational	105 originating test line: loss self check at -16 dB and frequencies of 404 Hz, 1004 Hz, and 2804 Hz, noise self check (C-notch filter), and return loss self check
TSBT	transmission	105 originating test line: return loss measurement
TSYN	operational	synchronous test
TS05	operational	105 originating test line: far-end loss self check and far-end noise self check
TS65	operational	105 originating test line: far-end loss self check at -16 dB and frequencies of 404 Hz, 1004 Hz, and 2804 Hz, and noise self check (C-notch filter)
T100	transmission	combined S100 and N100 tests
T102	transmission	milliwatt test: far-to-near loss measurement
T103	operational	non-synchronous test
T104	transmission	104 test line: loss measurements in both directions, far-to-near noise measurement and near-to-far noise check

ATTSCHEDED (continued)**Automatic trunk tests (Sheet 5 of 5)**

Test	Applicability	Test description
T165	transmission	105 originating test line: loss measurement at 404 Hz, 1004 Hz, and 2804 Hz at -16 dB with self check and noise measurement with tone (C-notch) and self check
T4AS	transmission	105 originating test line: loss measurement and self check at 0 dB and 1004 Hz, noise measurement and self check (C-message filter), and return loss measurement and self check
T4AT	transmission	105 originating test line: loss measurement at 0 dB and 1004 Hz, noise measurement (C-message filter), and return loss measurement
T5BS	transmission	105 originating test line: return loss measurement and self check
T5LB	transmission	105 originating test line: loss measurement at -16 dB and 404 Hz, 1004 Hz, and 2804 Hz with return loss measurement
T5LH	transmission	105 originating test line: singing return loss (high and low) measurement
T5SB	operational	105 originating test line: return loss self check
T50L	transmission	105 originating test line: loss measurement at 0 dB and 1004 Hz with return loss measurement
T56N	transmission	105 originating test line: loss measurement at -16 dB and 404 Hz, 1004 Hz, and 2804 Hz, noise measurement with C-notch filter, and return loss measurement

ATTSCHEDED (continued)

Tests that are not applicable to automatic trunk testing are listed in table Tests are not applicable to automatic trunk tests.

Tests that are not applicable to automatic trunk tests

Test	Applicability	Test description
S104	transmission	104 test line: loss measurement in both directions
TCLC	operational	short circuit test line (manual test only)
TCON	operational	CCIS continuity test
TCOT	operational	CCIS No. 6 continuity test
TLPB	transmission	looparound (manual test only)
TOPC	operational	open circuit test line (manual test only)
TS31	not defined	reserved for future use
T106	not defined	reserved for future use
T107	not defined	reserved for future use
T108	operational	echo suppression test (manual test only)
T109	not defined	reserved for future use

ATT BERT test incompatibility with LCM, LGC REX test

Do not schedule the ATT BERT test (datafilled in table ATTSCHEDED) to be run simultaneously with the LCM and LGC REX tests (datafilled in table REXSCHEDED). Simultaneous scheduling of LCM and LGC REX tests with the ATT BERT test causes the trunks being tested to become inoperable and the ATT BERT test will fail. The log ATT122 is generated when these tests are scheduled simultaneously.

ATT test incompatibility with NT5X30, NT2X90, and NT2X72 circuit packs

The Meridian SL-100 cabinetized system does not support ATT tests on HSET trunks (NT5X30), MONTALK trunks (NT2X90), and 4-wire E&M trunk interfaces (NT2X72) located in maintenance trunk modules (MTM). To test NT5X30, NT2X90, and NT2X72 circuit packs residing in MTMs, manually initiate the tests from the trunk test position (TTP).

Datafill sequence and implications

Table CLLI must be datafilled before table ATTSCHEDED.

ATTSCHEDED (continued)**Table size**

Memory is automatically allocated for 8191 tuples.

Datafill

The following table lists datafill for table ATTSCHEDED.

Field descriptions (Sheet 1 of 2)

Field	Subfield or refinement	Entry	Explanation and action
ATTKEY		see subfields	Automatic trunk test key. This field consists of subfields CLLI and TESTNAME.
	CLLI	alphanumeric (1 to 16 characters)	Common language location identifier. Enter the code of the outgoing or two-way trunk group requiring a test. Any fixed common language location identifier (CLLI) code (defined in table CLLI) must be entered in this field exactly as entered in table CLLI. For example, three-port conference circuits must be entered as CF3P. Up to 8191 distinct CLLIs are allowed.
	TESTNAME	alphanumeric (1 to 4 characters)	Test name. Enter the name of the type of test that is to be performed on the outgoing or two-way trunk group specified in subfield CLLI.
ABORTGRP		Y or N	Abort group. Enter Y (yes) if testing of trunk group is not required. Otherwise, enter N (no).
TSTSCHED		see subfield	Automatic trunk test schedule (frequency). This field consists of subfield ATTINTVL.
	ATTINTVL	DLY, DYOM, EDY, EVM, EWK, HRY, IQT, MTH, ODM, ODY, OWK, QTR, SAN, or WKY	Automatic trunk test interval. Enter the time of the automatic trunk test interval. Enter DLY (daily), EDY (even days only), or ODY (odd days only) and datafill refinements HOUR and MIN in section ATTINTVL = DLY, EDY, or ODY. Enter DYOM (day of month) and datafill refinements DAYOFM, HOUR, and MIN in section ATTIINTVL = DYOM..

ATTSCHE (continued)**Field descriptions (Sheet 2 of 2)**

Field	Subfield or refinement	Entry	Explanation and action
	ATTINTVL (continued)		<p>Enter EVM (even month), ODM (odd month), or MTH (monthly) and datafill refinements WOM, DOFWK, HOUR, and MIN in section ATTINTVL = EVM, ODM, or MTH. An even month denotes February, April, June, August, October, and December. An odd month denotes January, March, May, July, September, and November.</p> <p>Enter EWK (even weeks), OWK (odd weeks), or WKY (weekly) and datafill refinement DAYOFWK, HOUR, and MIN in section ATTINTVL = EWK, OWK, WKY.</p> <p>Enter HRY (hourly) and datafill refinement MIN in section ATTINTVL = HRV..</p> <p>Enter IQT (international quarter) and datafill refinements MOFQTR, WOM, DOFWK, HOUR, and MIN in section ATTINTVL = IQT..</p> <p>Enter QTR (quarterly) and datafill refinements MOFQTR, DAYOFM, HOUR, and MIN in section ATTINTVL = QTR..</p> <p>Enter SAN (semiannual) and datafill refinements MOFSY, WOM, DOFWK, HOUR, and MIN in section ATTINTVL = SAN.</p>

ATTSCHEDED (continued)**ATTINTVL = DLY, EDY, or ODY**

If the entry in field ATTINTVL is DLY, EDY, or ODY, datafill refinements HOUR and MIN as described below.

Field descriptions for conditional datafill

Field	Subfield or refinement	Entry	Explanation and action
	HOUR	numeric (0 to 23)	Hour. Enter the hour during the day of the week, that the test must commence.
	MIN	numeric (0 to 59)	Minute. Enter the minute of the hour, on the day of the week, that the test must commence. If the entry in field ATTINTVL is HRY, there is a tolerance of ± 10 min. For example, a datafill of HRY 30 can run at any time between 20 and 40 min past the hour.

ATTINTVL = DYOM

If the entry in field ATTINTVL is DYOM, datafill refinements DAYOFM, HOUR, and MIN as described below.

Field descriptions for conditional datafill

Field	Subfield or refinement	Entry	Explanation and action
	DAYOFM	numeric (1 to 31)	Day of month. Enter the day of the month when the test must be performed.
	HOUR	numeric (0 to 23)	Hour. Enter the hour during the day of the week, that the test must commence.
	MIN	numeric (0 to 59)	Minute. Enter the minute of the hour, on the day of the week, that the test must commence. If the entry in field ATTINTVL is HRY, there is a tolerance of ± 10 min. For example, a datafill of HRY 30 can run at any time between 20 and 40 min past the hour.

ATTSCHE (continued)**ATTINTVL = EVM, ODM, or MTH**

If the entry in field ATTINTVL is EVM, ODM, or MTH, datafill refinements WOM, DOFWK, HOUR, and MIN as described below.

Field descriptions for conditional datafill

Field	Subfield or refinement	Entry	Explanation and action
	WOM	numeric (1 to 5)	Week of month. Enter the week of the month on which the test must be performed. Week 1 is the first whole week of a month beginning with a Monday. Week 4 or 5 can include days belonging to the following month.
	DOFWK	numeric (0 to 6)	Day of week. Enter the day during the week on which the test must be performed: 0 (Monday), 1 (Tuesday), 2 (Wednesday), 3 (Thursday), 4 (Friday), 5 (Saturday), or 6 (Sunday).
	HOUR	numeric (0 to 23)	Hour. Enter the hour during the day of the week, that the test must commence.
	MIN	numeric (0 to 59)	Minute. Enter the minute of the hour, on the day of the week, that the test must commence. If the entry in field ATTINTVL is HRY, there is a tolerance of ± 10 min. For example, a datafill of HRY 30 can run at any time between 20 and 40 min past the hour.

ATTSCHEDED (continued)**ATTINTVL = EWK, OWK, or WKY**

If the entry in field ATTINTVL is EWK, OWK, or WKY, datafill refinements DAYOFWK, HOUR, and MIN as described below.

Field descriptions for conditional datafill

Field	Subfield or refinement	Entry	Explanation and action
	DAYOFWK	numeric (0 to 6)	Day of week. Enter the day during the week on which the test must be performed: 0 (Monday), 1 (Tuesday), 2 (Wednesday), 3 (Thursday), 4 (Friday), 5 (Saturday), or 6 (Sunday).
	HOUR	numeric (0 to 23)	Hour. Enter the hour during the day of the week, that the test must commence.
	MIN	numeric (0 to 59)	Minute. Enter the minute of the hour, on the day of the week, that the test must commence. If the entry in field ATTINTVL is HRY, there is a tolerance of ± 10 min. For example, a datafill of HRY 30 can run at any time between 20 and 40 min past the hour.

ATTINTVL = HRY

If the entry in field ATTINTVL is HRY, datafill refinement MIN as described below.

Field descriptions for conditional datafill

Field	Subfield or refinement	Entry	Explanation and action
	MIN	numeric (0 to 59)	Minute. Enter the minute of the hour, on the day of the week, that the test must commence. If the entry in field ATTINTVL is HRY, there is a tolerance of ± 10 min. For example, a datafill of HRY 30 can run at any time between 20 and 40 min past the hour.

ATTSCHEd (continued)**ATTINTVL = IQT**

If the entry in field ATTINTVL is IQT, datafill refinements MOFQTR, WOM, DOFWK, HOUR, and MIN as described below.

Field descriptions for conditional datafill

Field	Subfield or refinement	Entry	Explanation and action
	MOFQTR	numeric (0 to 2)	Month of quarter. Enter the month of the quarter during which the test must be performed.
	WOM	numeric (1 to 5)	Week of month. Enter the week of the month on which the test must be performed. Week 1 is the first whole week of a month beginning with a Monday. Week 4 or 5 can include days belonging to the following month.
	DOFWK	numeric (0 to 6)	Day of week. Enter the day during the week on which the test must be performed: 0 (Monday), 1 (Tuesday), 2 (Wednesday), 3 (Thursday), 4 (Friday), 5 (Saturday), or 6 (Sunday).
	HOUR	numeric (0 to 23)	Hour. Enter the hour during the day of the week, that the test must commence.
	MIN	numeric (0 to 59)	Minute. Enter the minute of the hour, on the day of the week, that the test must commence. If the entry in field ATTINTVL is HRY, there is a tolerance of ± 10 min. For example, a datafill of HRY 30 can run at any time between 20 and 40 min past the hour.

ATTSCHEDED (continued)**ATTINTVL = QTR**

If the entry in field ATTINTVL is QTR, datafill refinements MOFQTR, DAYOFM, HOUR, and MIN as described below.

Field descriptions for conditional datafill

Field	Subfield or refinement	Entry	Explanation and action
	MOFQTR	numeric (0 to 2)	Month of quarter. Enter the month of the quarter during which the test must be performed.
	DAYOFM	numeric (1 to 31)	Day of month. Enter the day of the month (1 to 31) when the test must be performed.
	HOUR	numeric (0 to 23)	Hour. Enter the hour during the day of the week, that the test must commence.
	MIN	numeric (0 to 59)	Minute. Enter the minute of the hour, on the day of the week, that the test must commence. If the entry in field ATTINTVL is HRY, there is a tolerance of ± 10 min. For example, a datafill of HRY 30 can run at any time between 20 and 40 min past the hour.

ATTINTVL = SAN

If the entry in field ATTINTVL is SAN, datafill refinements MOFSY, WOM, DOFWK, HOUR, and MIN as described below.

Field descriptions for conditional datafill (Sheet 1 of 2)

Field	Subfield or refinement	Entry	Explanation and action
	MOFSY	numeric (1 to 6)	Month of semiyear. Enter the month of the semiyear on which the test must be performed.
	WOM	numeric (1 to 5)	Week of month. Enter the week of the month on which the test must be performed. Week 1 is the first whole week of a month beginning with a Monday. Week 4 or 5 can include days belonging to the following month.

ATTSCHE (continued)**Field descriptions for conditional datafill (Sheet 2 of 2)**

Field	Subfield or refinement	Entry	Explanation and action
	DOFWK	numeric (0 to 6)	Day of week. Enter the day during the week on which the test must be performed: 0 (Monday), 1 (Tuesday), 2 (Wednesday), 3 (Thursday), 4 (Friday), 5 (Saturday), or 6 (Sunday).
	HOUR	numeric (0 to 23)	Hour. Enter the hour during the day of the week, that the test must commence.
	MIN	numeric (0 to 59)	Minute. Enter the minute of the hour, on the day of the week, that the test must commence. If the entry in field ATTINTVL is HRY, there is a tolerance of ± 10 min. For example, a datafill of HRY 30 can run at any time between 20 and 40 min past the hour.

ATTINTVL = all entries

For all entries in field ATTINTVL, datafill fields MAXTEST, TESTDLY, and TSTSEQ.

Field descriptions for conditional datafill (Sheet 1 of 2)

Field	Subfield or refinement	Entry	Explanation and action
MAXTEST		numeric (0 to 999)	Maximum test time. Enter the maximum consecutive number of ten-minute intervals that each trunk's test is to run. An entry of 0 (zero) means no limit.

ATTSCHEDED (continued)

Field descriptions for conditional datafill (Sheet 2 of 2)

Field	Subfield or refinement	Entry	Explanation and action
TESTDLY		EXLONGDLY, MEDDLY, L, or S	<p>Automatic trunk test delay. Enter the duration (number of seconds) of the delay allowed before the remote end drops during a trunk test.</p> <ul style="list-style-type: none"> • S = (short delay), 1 s • MEDDLY = (medium delay), 6 s • L = (long delay), 9 s • EXLONGDLY = (extra-long delay), 15 s
TSTSEQ		ATME ATME1 MAN MAN1 MAN2 MAN3 MAN4 NSTD QUAR PERDPERD1 or SYR	<p>Automatic trunk test sequence. Indicates the general frequency of the ATTs to be run. This field is equivalent to the TSTCLASS field in Table ATTOPNS and links Table ATTSCHEDED with Table ATTOPNS. (The test class name is the index into table ATTOPTNS which contains the automatic trunk test control data that does not pertain to specific trunk groups.)</p> <p>Enter an automatic trunk test name:</p> <ul style="list-style-type: none"> • ATMC, ATME1 = automatic test measuring equipment • MAN, MAN1, MAN2, MAN3, MAN4 = manual • NSTD = non-standard • QUAR = quarterly • PERD, PERD1 = periodic • SYR = semi-yearly

Datafill example

Two examples of datafill for table ATTSCHEDED are shown below.

The first example is for a local or local/toll switching unit and consists of the following tests:

- An inactive milliwatt transmission test schedule for a trunk group with a CLLI of OTWAON232370. The test is scheduled to perform on a specific day of the month, and to commence at 2:01 a.m. on the first day of the month. The maximum length of time for the test is 30 min. A short delay,

ATTSCHEDED (continued)

1 s, is allowed for the far end to drop. The test sequence, in table ATTOPTNS, pointed to is PERD.

- An active diagnostic operational test for a trunk group with a CLLI of OTWAON1002T1. The test is scheduled weekly and is to be performed at 1:01 a.m. on the second day of every week. The maximum length of time for the test is 20 min. A long delay, 9 s, is allowed for the far end to drop. The test sequence, in table ATTOPTNS, pointed to is PERD.

MAP display example for table ATTSCHEDED

ATTKEY	ABORTGRP	TSTSCHEDED	MAXTEST	TESTDLY	TSTSEQ
OTWAON232370	T102	N	DYOM 1 2 1 3	S	PERD
OTWAON1002T1	T104	Y	WKY 1 1 1 2	L	PERD

The second example is for a gateway switching unit and consists of the following tests:

- A TA21 type test is scheduled for a trunk group with a CLLI of SYD04. The test is scheduled quarterly on the fourth day of the second month of each quarter at 2:01 a.m. for a maximum of 20 min. A short delay, 1 s, is allowed for the far end to drop. The test sequence, in table ATTOPTNS, pointed to is ATME.
- A TA02 type test is scheduled for a trunk group with a CLLI of ANK01. The test is scheduled for each week on a Monday at 3:00 a.m. for a maximum length of 10 min. A short delay, 1 s, is allowed for the far end to drop. The test sequence, in table ATTOPTNS, pointed to is ATME.

MAP display example for table ATTSCHEDED

ATTKEY	ABORTGRP	TSTSCHEDED	MAXTEST	TESTDLY	TSTSEQ
SYD01 TA21	Y	QTR 2 4 2 1	2	S	ATME
ANK01 TA02	Y	WKY 0 3 0	1	S	ATME

ATTSCHEDED (end)

Table history

NA007

Added information on ATT test incompatibility with NT5X30, NT2X90, and NT2X72 circuit packs.

NA007

Added information on ATT BERT test schedule incompatibility with the LCM and LGC REX test.

NA007

Expanded explanations for fields MAXTEST, TESTDLY, and TSTSEQ.

BCS36

Added limitation explanation to field MIN if field ATTINTVL is set to HRY.

DMS-100 Family

North American DMS-100

Customer Data Schema Reference Manual

Volume 1 of 12

Data Schema AABSFLT-ATTSCHE

Product Documentation - Dept. 3423

Nortel Networks

P.O. Box 13010

RTP, NC 27709-3010

Telephone: 1-877-662-5669

Electronic mail: cits@nortelnetworks.com

Copyright © 1996-2001 Nortel Networks,

All Rights Reserved

NORTEL NETWORKS CONFIDENTIAL: The information contained in this document is the property of Northern Telecom. Except as specifically authorized in writing by Northern Telecom, the holder of this document shall keep the information contained herein confidential and shall protect same in whole or in part from disclosure and dissemination to third parties and use same for evaluation, operation, and maintenance purposes only.

Information is subject to change without notice. Nortel Networks reserves the right to make changes in design or components as progress in engineering and manufacturing may warrant.

Changes or modification to the DMS-100 without the express consent of Nortel Networks may void its warranty and void the user's authority to operate the equipment.

Nortel Networks, the Nortel Networks logo, the Globemark, How the World Shares Ideas, Unified Networks, DMS, DMS-100, Helmsman, MAP, Meridian, Nortel, Northern Telecom, NT, Supernode, and TOPS are trademarks of Nortel Networks.

Publication number: 297-8021-351

Product release: LET0015 and up

Document release: Standard 05.02

Date: May 2001

Printed in the United States of America

