

# Critical Release Notice

**Publication number: 297-8021-351**  
**Publication release: Standard 12.02**

## **Attention!**

\*\*\*\*\*

The North America DMS-100 Data Schema Reference Manual, 297-8021-351, will continue to be updated and provided in the North America - DMS NTP collection.

\*\*\*\*\*

The content of this customer NTP supports the SN09 (DMS) software release.

Bookmarks used in this NTP highlight the changes between the NA015 baseline and the SN08 (DMS) release. The bookmarks provided are color-coded to identify release-specific content changes. NTP volumes that do not contain bookmarks indicate that the NA015 baseline remains unchanged and is valid through the SN08 (DMS) release.

## **Bookmark Color Legend**

**Black:** Applies to content for the NA015 baseline that is valid through the current release.

**Red:** Applies to new or modified content for NA017 that is valid through the current release.

**Blue:** Applies to new or modified content for NA018 (SN05 DMS) that is valid through the current release.

**Green:** Applies to new or modified content for SN06 (DMS) that is valid through the current release.

**Purple :** Applies to new or modified content for SN07 (DMS) that is valid through the current release.

**Pink:** Applies to new or modified content for the SN08 (DMS) that is valid through the current release.

**Orange:** Applies to new or modified content for SN09 (DMS) that is valid through the current release.

## **Attention!**

*Adobe® Acrobat® Reader™ 5.0 or higher is required to view bookmarks in color.*

# Publication History

*Note: Refer to the NA015 baseline document for Publication History prior to the NA017 software release.*

## January 2006

Standard NTP release 12.02 for the SN09 (DMS) software release.

### Volume 1

Modified data schema – AMAOPTS (A00009252)

### Volume 4

Modified data schema – ESAPXLA (Q01228425-01)

### Volume 6

Modified data schema – IPNETWRK (Q01215905 and Q01227402)

### Volume 7

Modified data schema – LNSMTCE (Q00959081)

### Volume 9

New data schema – PATHSET (modified by Q01077097)

New data schema – SBSRMINV (Q01063949)

### Volume10

New data schema – SERVIRINV (Q01063949)

### Volume12

Deleted the term TBD, which occurred in two places in this volume.

## September 2005

Preliminary NTP release 12.01 for the SN09 (DMS) software release.

### Volume 1

Modified data schema – AMAOPTS (A00009252, A00009508); ANNMEMS, ANNPHLST (A00009013)

### Volume 8

Modified data schema – OAFUNDEF (A00009012)

### Volume 9

Modified data schema – SCAICOMS (A00009078)

**Volume 11**

Modified data schema – TOPSFTR (A00009012)

**Volume 12**

Modified data schema – TRKSGRP type ISDN (Q01112597)

Modified data schema – XPMIPMAP (A00009011)

**August 2005**

Standard NTP release 11.03 for the SN08 (DMS) software release.

**Volume 5**

Modified data schema – IBNFEAT feature SimRing

**Volume 6**

Modified data schema – KSETFEAT feature SimRing

**Volume 7**

Modified data schema – LTCINV

**Volume 11**

New data schema – TOPSMCDB

Modified data schema – TOPSTOPT

**June 2005**

Standard NTP release 11.02 for the SN08 (DMS) software release.

The following Data Schema content is updated for the SN08 (DMS) release. Content provided in this NTP is not superseded by content provided in the replacement NTP as indicated for the Preliminary release.

**Volume 3**

New data schema – CUSTSTN option CNDBO

**Volume 4**

Modified data schema – EADAS

**Volume 6**

New data schema – KSETINV

New data schema – LCMINV

**Volume 8**

New data schema – NSCDEFS

New data schema – NSCPMAP

## March 2005

Preliminary NTP release 11.01 for the SN08 (DMS) software release.

The following updated Data Schema content is provided in the Carrier VoIP Operational Configuration: Data Schema Reference NTP, NN10324-509. The content provided in NTP 297-8021-351 is superseded by the content provided in NTP NN10324-509.

ACDMISPL  
CGBLDADD  
CGBLDDGL  
CGBLDDIG  
CGBLDNI  
CGBLDPI  
CGPNBLDR  
CUSTSTN\_OPTION\_DBO  
EDAS  
IBNLINES  
ISERVOPT  
KSETINV  
TLDSIAMA\_OPTS  
TRKSGRP\_TYPE\_C7UP

The following new Data Schema content is provided in the Carrier VoIP Operational Configuration: Data Schema Reference NTP, NN10324-509. This content will not be provided in NTP 297-8021-351.

CGBLDSIN  
LOGTHROT  
NTPOLL

## October 2005

Standard release 10.04 for software release SN07 (DMS). Updates made in the North American Data Schema Reference Manual are shown below

### Volume 2

Table BEARNETS description added for CR Q01083765.

### Volume 3

Table DESDATA description added for CR Q01083765.

### Volume 4

Table DPTRKMEM was created as part of activity A59015739 in an earlier release. Documentation updated for CR Q01083781.

### **Volume 5**

Table IHEADRR description added for CR Q01083765.

### **Volume 8**

Table NET2NET description added for CR Q01083765

Table NETBRDGE description added for CR Q01083765

Table NETPATH description added for CR Q01083765

### **Volume 9**

Table PCEMENTT was created as part of activity A00007196 in an earlier release.  
Documentation updated for CR Q01077110.

Table PCEMFEID was created as part of activity A00007196 in an earlier release.  
Documentation updated for CR Q01077137.

Table PRSUDATA description added for CR Q01083765.

Table PVDNCHAN description modified for CR Q00806759/Q01207784

### **Volume 10**

Table SELDEFS and table SETDEFS descriptions added for CR Q01083765.

## **December 2004**

Standard release 10.03 for software release SN07 (DMS). Updates made in the North America Data Schema Reference Manual are shown below

### **Volume 9**

Table PECINV amended for CR Q00900178

Standard release 10.02 for software release SN07 (DMS). Updates made in the North America Data Schema Reference Manual are shown below

### **Volume 1**

AINPRESC (new), ACDENLOG, ACDGRP, ACDLOGIN, ANNS

### **Volume 2**

No changes

### **Volume 3**

CMIPADDR, CUSTSTN option AINDENY

### **Volume 4**

No changes

### **Volume 5**

IBNFEAT feature ACD, IBNFEAT feature SUPR

**Volume 6**

IPAPPL (new), KSETFEAT feature SUPR, KSETFEAT feature IPCLIENT, KSETLINE feature ACD

**Volume 7**

No changes

**Volume 8**

MULTITM (new), OAFUNDEF, OANODINV

**Volume 9**

PADDDATA, QMSMIS

**Volume 10**

No changes

**Volume 11**

TOPSFTR, TOPTDROP, TRIGINFO, TRIGITM, TRKAIN

**Volume 12**

No changes

**September 2004**

Preliminary release 10.01 for software release SN07 (DMS). Updates made in the North America Data Schema Reference Manual are shown below

**Volume 1**

ACDENLOG, ACDGRP, ACDLOGIN

**Volume 2**

AUTHCDE

**Volume 3**

CUSTN, CUSTN option VOWDN (new)

**Volume 4**

DIRPOOL2 (new), DIRPPool, DNROUTE, DNROUTE feature VOWDN (new)

**Volume 5**

IBNFEAT feature ECM, IBNXLA

**Volume 6**

ISUPTRK, KSETFEAT feature ECM

**Volume 7**

LIUINV, LTCINV, MNHSCARR, MSCIDMAP (new), MSCINMAP (new)

**Volume 8**

MUMRTAB

**Volume 9**

RESFEAT

**Volume 10**

TDBDAOPT, TMTMAP

**Volume 11**

TOLLTRKS, TOPSFTR, TOPSPARM, TOPSTLDN

**Volume 12**

TRKOPTS, VOWINV (new), XLABILL (new), XLACCLASS (new)

**March 2004**

Standard release 09.03 for software release SN06 (DMS). Updates made in the North America Data Schema Reference Manual are shown below.

**Volume 1**

DCA references changed / made obsolete

**Volume 2**

CARRMTC, C7UPTMR

**Volume 3**

DCA references changed / made obsolete

**Volume 4**

DNROUTE, DNROUTE feature DISA

**Volume 5-6**

No changes

**Volume 7**

LNPOPTS, LTDATA

**Volume 8**

OPTOPT

**Volume 9**

PADDATA, RDTINV

**Volume 10**

SUSHELF, SYNCLK, DCA references changed / made obsolete

**Volume 11-12**

No changes

**September 2003**

Standard release 09.02 for software release SN06 (DMS). Updates made in the North America Data Schema Reference Manual are shown below.

**Volume 1**

No changes

**Volume 2**

BCCODES

**Volume 3**

CSEDPMAP

**Volume 4**

DSLIMIT, FNPACONT.RTEREF

**Volume 5**

HNPACONT.RTEREF, IBNFEAT feature MWT, IBNLINES option MDN, IBNLINES option STN, IBNRTE selector CND, IBNRTE selector NOT, IBNXLA, IBNXLA selector FTR type LSPKP

**Volume 6**

ISDNPARM, ISERVOPT, KSETLINE

**Volume 7**

LENLINES, LTCINV, MNMGPIP

**Volume 8**

OFRT selector CND, OFRT selector NOT

**Volume 9**

No changes

**Volume 10**

STDPRTCT.STDPRT selector E911

**Volume 11**

TODHEAD, TONES, TRKGRP E911, TRKGRP type IT



## **Volume 12**

TRKOPTS, VFGDATA, VIRGRPS

### **June 2003**

Preliminary release 09.01 for software release SN06 (DMS). Updates made in the North America Data Schema Reference Manual are shown below.

## **Volume 1**

ACRTE, ALMSC, ALMSCGRP, ALMSD, ALDSDGRP, ANNAUDID (new), ANNMEMS, ANNPHLST (new)

## **Volume 2**

No changes

## **Volume 3**

CSEDPMAP (new), CUSTN option CFIND, DEFDATA

## **Volume 4**

FNPACONT

## **Volume 5**

HNPACONT, IBNFEAT feature CFIND, IBNLINES, IBNRTE selector CND, IBNRTE selector NOT

## **Volume 6**

ISERVOPT, KSETLINE

## **Volume 7**

LRGPINV (new), LTDATA, MNCKTPAK, MNIPPARM (new), MNNODE

## **Volume 8**

OFRT selector CND, OFRT selector NOT

## **Volume 9**

PADDDATA, REXSCHED

## **Volume 10**

SERVSINV, SPMECAN, SPMLDVAL (new), STDPRTCT.STDPRT selector E911

## **Volume 11**

TODHEAD, TONES, TRKGRP E911, TRKGRP type IT

## **Volume 12**

TRKMEM, TRKOPTS, TRKSGRP, VFGDATA, VIRTGRPS

**This page is intentionally blank.**

297-8021-351

DMS-100 Family

## **North American DMS-100**

Customer Data Schema Reference Manual Volume 2 of 12

Data Schema AUDALARM-CCVPARMS

LET0015 and up Standard 05.02 May 2001

---



---

DMS-100 Family

## **North American DMS-100**

Customer Data Schema Reference Manual Volume 2 of 12

Data Schema AUDALARM-CCVPARMS

---

Publication number: 297-8021-351

Product release: LET0015 and up

Document release: Standard 05.02

Date: May 2001

---

Copyright © 1996-2001 Nortel Networks,  
All Rights Reserved

Printed in the United States of America

**NORTEL NETWORKS CONFIDENTIAL:** The information contained herein is the property of Nortel Networks and is strictly confidential. Except as expressly authorized in writing by Nortel Networks, the holder shall keep all information contained herein confidential, shall disclose the information only to its employees with a need to know, and shall protect the information, in whole or in part, from disclosure and dissemination to third parties with the same degree of care it uses to protect its own confidential information, but with no less than reasonable care. Except as expressly authorized in writing by Nortel Networks, the holder is granted no rights to use the information contained herein.

Information is subject to change without notice. Nortel Networks reserves the right to make changes in design or components as progress in engineering and manufacturing may warrant. Changes or modification to the DMS-100 without the express consent of Nortel Networks may void its warranty and void the user's authority to operate the equipment.

Nortel Networks, the Nortel Networks logo, the Globemark, How the World Shares Ideas, Unified Networks, DMS, DMS-100, Helmsman, MAP, Meridian, Nortel, Northern Telecom, NT, SuperNode, and TOPS are trademarks of Nortel Networks.

---



---

# Contents

---

## Customer Data Schema Reference Manual Volume 2 of 12 Data Schema AUDALARM-CCVPARMS

### NTP Summary Contents vii

---

<b>1</b>	<b>Data schema tables</b>	<b>1-1</b>
	AUDALARM 1-2	
	AUDIO 1-4	
	AUDPRGM 1-13	
	AUTHCDE 1-15	
	AUTHGRP 1-23	
	AUTHPART 1-28	
	AUTHSGRP 1-33	
	AUTOEXEC 1-36	
	AUTOHIB 1-39	
	AUTOTAB 1-41	
	BAGNAME 1-45	
	BANASYM 1-47	
	BANDSETS 1-49	
	BCCODES 1-51	
	BCCOMPAT 1-65	
	BCDEF 1-71	
	BCLIDGRP 1-82	
	BCLIDLNK 1-86	
	BELLCAT 1-89	
	BGDATA 1-97	
	BGLOCN 1-104	
	BILLCODE 1-107	
	BITGPER 1-110	
	BLDDATA 1-113	
	BLMTHRSH 1-116	
	BNMCUST 1-120	
	BNSAGRMT 1-122	
	BNSINFO 1-124	
	BNSPARMS 1-127	
	BRANDANN 1-132	
	BRANDOPT 1-137	
	C6LAYER 1-144	

C6LKSET	1-146
C6TRKMEM	1-149
C7AFTPC	1-151
C7ALIAS	1-156
C7ALWDPC	1-165
C7ALWGTT	1-172
C7ALWOPC	1-177
C7ALWSIO	1-186
C7BLKDPC	1-196
C7BLKOPC	1-207
C7BLKSIO	1-218
C7CDPA	1-225
C7CGPA	1-232
C7CNGSTN	1-242
C7DCIS6	1-253
C7DPCTAB	1-259
C7DSTFLD	1-262
C7GATEPC	1-270
C7GATERS	1-272
C7GTINT	1-274
C7GTNAT	1-293
C7GTT	1-298
C7GTTDF	1-311
C7GTTYPE	1-324
C7GTWLKS	1-332
C7ICCVCD	1-348
C7ICCVCG	1-350
C7ISL	1-353
C7LINK	1-354
C7LKPARAM	1-371
C7LKSET	1-376
C7LOCSSN	1-397
C7NETSSN	1-404
C7NETWRK	1-414
C7OPCTAB	1-434
C7PECRCD	1-437
C7PECRCG	1-439
C7ROUTER	1-441
C7RPLSSN	1-445
C7RSSCRN	1-452
C7RTESET	1-456
C7TIMER	1-474
C7TRKMEM	1-522
C7UPTMR	1-526
C7UPTMR signaling protocol AISUP	1-532
C7UPTMR signaling protocol ATUP	1-564
C7UPTMR signaling protocol BTUP	1-587
C7UPTMR signaling protocol CCITT250	1-606
C7UPTMR signaling protocol IBNISUP	1-635
C7UPTMR signaling protocol JPNISUP	1-654
C7UPTMR signaling protocol MBTUP	1-667



---

C7UPTMR signaling protocol NCCI	1-686
C7UPTMR signaling protocol Q764	1-704
C7UPTMR signaling protocol Q767	1-724
C7UPTMR signaling protocol TUP_BLUE	1-755
C7UPTMR signaling protocol TUPPLUS	1-779
CALLCHR	1-802
CAMACSW	1-804
CAMACSWs	1-807
CAPS	1-809
CARDBRND	1-811
CARRMTC	1-813
CARRTRF	1-872
CATCLASS	1-874
CATCODES	1-878
CCANFMT	1-881
CCC	1-884
CCCSOPTS	1-888
CCDGTAN	1-892
CCIN	1-895
CCLIST	1-897
CCNAMES	1-899
CCS7PPLN	1-902
CCSALARM	1-904
CCSDOC	1-912
CCTR	1-914
CCTRNSL	1-918
CCVAGRMT	1-927
CCVINFO	1-929
CCVPARMS	1-932



---

# NTP Summary Contents

---

**Customer Data Schema Reference Manual Volume 1 of 12**

Data Schema AABSFILT-ATTSCHEd

**Customer Data Schema Reference Manual Volume 2 of 12**

Data Schema AUDALARM-CCVPARMS

**Customer Data Schema Reference Manual Volume 3 of 12**

Data Schema CDACCESS-DFINV

**Customer Data Schema Reference Manual Volume 4 of 12**

Data Schema DGCODE-FTRGMEMS

**Customer Data Schema Reference Manual Volume 5 of 12**

Data Schema FTRGOPTS-INWTMAP

**Customer Data Schema Reference Manual Volume 6 of 12**

Data Schema IOC-LENFEAT feature WML

**Customer Data Schema Reference Manual Volume 7 of 12**

Data Schema LENLINES-MSRTAB

**Customer Data Schema Reference Manual Volume 8 of 12**

Data Schema MTAHORIZ-OPTOPT

**Customer Data Schema Reference Manual Volume 9 of 12**

Data Schema OQCQPROF-SCALLTAB

**Customer Data Schema Reference Manual Volume 10 of 12**

Data Schema SCCPTMR-TMZONE

**Customer Data Schema Reference Manual Volume 11 of 11**

Data Schema TODHEAD-TRKGRP type NU

**Customer Data Schema Reference Manual Volume 12 of 12**

Data Schema TRKGRP type OC-ZONEORDR

---

# 1 Data schema tables

---

The following pages contain the data schema tables.

## AUDALARM

---

### Table name

Audible Alarm Table

### Functional description

This table specifies the alarm level for log reports from the security subsystem. You cannot view and manipulate these reports. You can specify alarm levels for these reports in the following two methods:

- Through the use of table CMDS, you can specify if a report and alarm generates for each command.
- Through the use of table AUDALARM, you can specify an alarm level for logging each report.

Log devices do not print secret alarms. When a secret report causes an alarm, the alarm system generates a non-secret log. This non-secret log only records that an alarmed secret report is logged.

You cannot add or delete tuples from this table with the LOGUTIL facility at the MAP terminal. The LOG system adds tuples automatically at restart time. Each log report has the alarm level set to NA (no alarm) by default. The only correct user operation for this table is to change the alarm level of a report. Changes to the alarm level occur immediately. Restart is not required.

### Datafill sequence and meaning

You do not need to enter data in other tables before you enter data in table AUDALARM.

### Table size

One tuple is in this table for every secret log in the system.

64 tuples

**AUDALARM** (end)**Datafill**

Datafill for table AUDALARM appears in the following table.

**Field descriptions**

Field	Subfield or refinement	Entry	Explanation and action
LOGREP		alphanumeric (a maximum of 16 characters)	<i>Log report.</i> Enter a logname and report number, in the form of logname\$reportnumber, for example, SECU\$101. Only lognames and report numbers of secret logs are keys to this table.
ALARM		CR, MN, MJ, or NA	<i>Alarm level.</i> Enter the level of the alarm that the subsystem raises when a report is logged. The levels are, CR (critical alarm), MN (minor alarm), MJ (major alarm), or NA (no alarm). The entry in this field can only be changed. You cannot add or delete tuples.  The default entry for this field is NA.  <b>Note:</b> Changes to the alarm level take effect immediately. Restart is not required.

**Datafill example**

The system automatically inserts tuples in this table for each log report. The alarm level entries for these tuples are always set to the default value NA. The entries required to change the alarm level for log reports appear in the following table. These entries change log report SECU\$109 to major, and the alarm level for log report SECU\$111 to minor.

**MAP example for table AUDALARM**

LOGREP	ALARM
SECU\$109	MJ
SECU\$111	MN

## AUDIO

---

### Table name

Audio Interlude Table

### Functional description

Table AUDIO defines the audio interlude broadcasts. These broadcasts are for specified features for the Integrated Business Network (IBN). These broadcasts can include any of the following broadcast elements:

- announcement
- music
- silence
- ringing

Each tuple in the table specifies the audio broadcast issued for an audio group and feature name. The common language location identifier (CLLI) names of the announcement and music trunks appear in table AUDIO. The CLLI names must appear in tables ANN and ANNMEMS also.

Feature AD1128 is Second and Third Delay Announcement. This feature helps to provide a second and third announcement for calls that wait to be answered. With this feature, six different broadcast selections, connection selections, are available.

You can enter six connection selections in the route list. You can enter a total of two delay intervals. These intervals must occur between announcement routes. Subsequent announcements are permitted. You can enter a maximum of six subsequent announcements if delay intervals are not inserted.

The system allows a new route selection, ringing, during the delay time between announcements and the final route selection. If you specify ringing, the system prompts the delay time between announcements. This delay time is the delay threshold. A similar delay threshold field is also added to the music and silence route selectors. If the delay threshold is at 0 (zero), the treatment continues until the line is answered or abandoned. You cannot follow a selection of ringing, silence, or music by another selection of ringing, silence, or music.

Announcement cycles can repeat through the use of option REPEAT. Option repeat is only correct as the final selection. If you use option repeat, specify the route selection that needs to repeat. Only routes 2, 3, and 4 are correct.

Music, silence, or ringing can follow the final announcement. If the final selection is not music, silence, ringing, or repeat, silence is the default. If you



---

**AUDIO** (continued)

---

enter music, silence, or ringing as the final selection, the delay time must be 0 (zero). When you enter music, silence, or ringing with a delay time of 0, you cannot enter any more selections.

You cannot enter delay intervals for attendant consoles. Ringing and repeat options are not allowed. Music and silence are allowed as final choices only.

Announcements in audio interlude always start from the beginning of a cycle. This action applies to calls that arrive over a trunk or line. Some features have a known duration for ringback tone before the features switch to announcement. In these occurrences, the system adds the allowed time the announcement recording uses to reach the beginning of the cycle to the predetermined ringback time. This time is the total time available for ringing before switching. For example, consider the condition where a caller must hear audible ringing for 10 s, an announcement and music. The announcement cycle is 6 s long. If, after 10 s of ringing, the announcement is in mid-cycle, an additional 3 s of ringing is available. After the additional 3 s of ringing, the system switches to the beginning of the announcement.

To prevent cross talk, SILENCE tone must be assigned after the announcement or music CLLI.

Table AUDIO can specify the following features:

- Attendant Camp-on (CAMPON).  
For calls the attendant extends to a busy station, this feature defines the broadcast specified before the busy station became idle. The Attendant Camp-on (ACO) feature in table CUSTCONS enables or disables the broadcast.
- Attendant Hold with Audio (ACHOLD).  
This feature defines the broadcast specified to calls that the attendant put on hold. The attendant presses the HOLD key or another loop key. The Attendant Hold with Audio (ACHOLD) feature in table CUSTCONS enables or disables the broadcast.
- Attendant Queue (ATTQ).  
This feature defines the broadcast specified to calls that waits in the attendant queue. The Music On Hold (MHOLD) feature in table CUSTHEAD enables or disables the broadcast.
- Automatic Call Distribution Queue (ACDQ).  
This feature defines the broadcast specified to calls waiting in the queue for each Automatic Call Distribution (ACD) group. The ACD feature in table ACDGRP enables or disables the broadcast.

## AUDIO (continued)

---

If an audio group associated with an ACD public safety answering point (PSAP) group changes, a check runs. This check runs to verify that the AUDIO group does not specify MUSIC as an entry in field CHOICE. This check is done only if the optional E911 ACD software is present. The entry MUSIC is not allowed in an AUDIO group that associates with an ACD PSAP group.

The following warning message appears if an attempt is made to add MUSIC to an ACDQ tuple. The following warning message appears if the associated ACD group has option ACDPSAP entered in table ACDGRP:

```
THE ACD PSAP REFERENCES THE SPECIFIED AUDIO GROUP IN  
TABLE ACDGRP.  MUSIC IS NOT ALLOWED AS AN AUDIO CHOICE.
```

- **Call Hold (CHD).**

This feature defines the broadcast specified to calls put on hold by IBN stations. This feature flashes the hook switch and dials the call-hold access code entered in table IBNXLA for 500/2500 sets to activate the Call Hold. The Call Hold with Music (CHD) feature in table CUSTSTN enables or disables the broadcast.
- **Call Park (CPARK).**

This feature defines the broadcast specified to calls 500/2500 sets and business sets park. This feature flashes the hook switch and dials the call-park access code for 500/2500 sets to activate Call Park. Another method to activate Call Park is to press the key assigned to the Call Park feature for business sets. The Call Park (CPK) feature in table CUSTHEAD enables or disables the broadcast.
- **Call Waiting Originating (CWO).**

For stations with Call Waiting Originating assigned in table IBNLINES, this feature defines the broadcast specified before a busy line becomes idle. The Call Waiting Originating (CWO) feature in table CUSTSTN enables or disables the broadcast.
- **Dial Call Waiting (CWD).**

This feature defines the broadcast specified to stations with Dial Call Waiting (CWD) that waits for a busy line to become idle. The Dial Call Waiting (CWD) feature in table CUSTSTN enables or disables the broadcast.
- **Key Set Music On Hold (KSMOH).**

This feature defines a music broadcast for calls put on hold. Feature KSMOH in table CUSTSTN enables or disables the broadcast. Enter feature KSMOH in table IVDINV for integrated voice and data (IVD) telephones. Enter feature KSMOH in table KSETINV for business sets.

**AUDIO** (continued)

Table AUDIO supports entry KSMOH in field FTRINDEX for ISDN keysets.

- Meridian Business Set Camp-on (MBSCAMP).

This feature allows feature MBSCAMPO in table CUSTSTN to provide music, announcement, ringing, or silence. These options are for calls to Meridian Business Sets (MBS) that are camped-on. Enter feature MBSCAMP in tables CUSTSTN, KSETFEAT, KSETLINE, LCCOPT, OPTOPT, and REASONS.

- Multiple Position Hunt with Queue (MPHQ).

This feature distributes calls evenly across multiple non-data link attendant consoles. The system presents calls to the consoles in the order that the calls arrive at the DMS-100 Family switch. The DMS-100 switch enqueues calls that the system cannot present to any console. The This feature places these calls in a queue until a console is available to serve that call.

- Permanent Hold (PHOLD).

This feature defines the broadcast specified to calls that IBN stations put on permanent hold. This feature flashes the hook switch and dials the permanent-hold access code in table IBNXLA to activate Permanent Hold. The Permanent Hold (PHOLD) feature in table CUSTSTN enables or disables the broadcast. Feature Permanent Hold is not available to business set stations.

- Single Line Queue (SLQQ).

This feature defines the broadcast specified to calls that wait to be served in the SLQ queue. This feature allows SLQ lines to select an announcement type.

- Uniform Call Distribution Queue (UCDQ).

This feature defines the broadcast specified to calls that wait to be served in the UCD queue. This condition occurs if the predicted delay exceeds the customer preset threshold. The Audio feature in table UCDGRP enables or disables the broadcast.

### **Datafill sequence and meaning**

You must enter data in the following tables before you enter data in table AUDIO:

- CLLI
- ANNS
- ANNMEMS

## AUDIO (continued)

---

### Table size

0 to 511 tuples

Table size is a string range. The number of entries in field GROUP determines the table size. You can enter a maximum of 512 audio group names (field GROUP).

### Datafill

Datafill for table AUDIO appears in the following table.

#### Field descriptions (Sheet 1 of 3)

Field	Subfield	Entry	Explanation and action
AUDIOKEY		see subfields	<i>Audio key.</i> This field contains subfields GROUP and FTRINDEX.
	GROUP	AUDIO1to AUDIO512	<i>Group.</i> Enter the audio group name required.

**AUDIO** (continued)**Field descriptions (Sheet 2 of 3)**

Field	Subfield	Entry	Explanation and action
	FTRINDEX	ACDQ, ACHOLD, ATTQ, CAMPON, CHD, CPARK, CWD, CWO, KSMOH, MBSCAMP, MPHQ, PHOLD, SLQQ, or UCDQ	<p><i>Feature index.</i> Enter a maximum of six features that require a broadcast. See the Functional description section for a description of each feature. If less than six features are required, end the list with a \$.</p> <p>Enter KSMOH for ISDN keysets.</p> <p>The valid feature entries are as follows:</p> <ul style="list-style-type: none"> <li>• ACDQ (Automatic Call Distribution Queue)</li> <li>• ACHOLD (Attendant Hold with Audio)</li> <li>• ATTQ (Attendant Queue)</li> <li>• CAMPON (Attendant Camp-on)</li> <li>• CHD (Call Hold)</li> <li>• CPARK (Call Park)</li> <li>• CWD (Dial Call Waiting)</li> <li>• CWO (Call Waiting Originating)</li> <li>• KSMOH (Key Set Music On Hold - also used by ETSI Call Hold (HOLD))</li> <li>• MBSCAMP (Meridian Business Set Camp-on)</li> <li>• MPHQ (Multiple Position Hunt with Queue)</li> <li>• PHOLD (Permanent Hold)</li> <li>• SLQQ (Single Line Queue)</li> <li>• UCDQ (Uniform Call Distribution Queue)</li> </ul>

**AUDIO** (continued)

**Field descriptions (Sheet 3 of 3)**

Field	Subfield	Entry	Explanation and action
ROUTES		see subfield	Routes. This field consists of up to 6 occurrences of subfield CHOICE and refinements.
	CHOICE	ANN, MUSIC, SILENCE, RINGING, or REPEAT	<p><i>Audio choice.</i> Enter ANN for announcement and datafill refinements AR, CYCLE and ANNCLLI in the next section on this page..</p> <p>Enter MUSIC for continuous music and datafill refinements MUSICLLI and TIME on the next page.</p> <p>Enter REPEAT to repeat a sequence and datafill refinement ROUTE on the next page.</p> <p>Enter RINGING for ringing and datafill refinement TIME on the next page.</p> <p>Enter SILENCE for absence of announcement or music and datafill refinement TIME on the next page.</p>

**CHOICE = ANN**

If the entry in subfield CHOICE is ANN, enter refinements AR, CYCLES, and ANNCLLI as refinements appear below.

**Field descriptions for conditional datafill**

Field	Subfield	Entry	Explanation and action
	AR	Y or N	<i>Audible ringing.</i> Enter Y if audible ringing is required before the announcement reaches the beginning of its cycle. If you require silence, enter N.
	CYCLES	1 to 30	<i>Announcement cycles.</i> Enter the number of announcement cycles required.
	ANNCLLI	alphanumeric (1 to 16 characters)	<i>Announcement common language location identifier.</i> Enter the CLLI of the announcement trunk, that must appear in tables ANN and ANNMEMS.

**AUDIO** (continued)**CHOICE = MUSIC**

If the entry in subfield CHOICE is MUSIC, enter refinements MUSICLLI and TIME as these refinements appear in the following table.

**Field descriptions for conditional datafill**

Field	Subfield	Entry	Explanation and action
	MUSICLLI	alphanumeric (1 to 16 characters)	<i>Music common language location identifier.</i> Enter the CLLI of the audio trunk, that must appear in table ANN and ANNMEMS.
	TIME	0 to 1800	<i>Time.</i> Enter the delay threshold time, in seconds. An entry of 0 (zero) provides continuous music and is correct as the last entry only.

**CHOICE = REPEAT**

If the entry in subfield CHOICE is REPEAT, enter refinement ROUTE as this refinement appears in the following table.

**Field descriptions for conditional datafill**

Field	Subfield	Entry	Explanation and action
	ROUTE	2 to 4	<i>Route.</i> Enter the route number where the repeat sequence begins.

**CHOICE = RINGING or SILENCE**

If the entry in subfield CHOICE is RINGING or SILENCE, enter refinement TIME as this refinement appears in the following table.

**Field descriptions for conditional datafill**

Field	Subfield	Entry	Explanation and action
	TIME	0 to 1800	<i>Time.</i> Enter the delay threshold time, in seconds. If the entry in subfield CHOICE is RINGING, enter 0 to provide continued ringing. This entry is correct as a final entry only. If the entry in subfield CHOICE is SILENCE, an entry of 0 provides continued silence and is correct as a final entry only.

**Datafill example**

Sample datafill for table AUDIO appears in the following example.

**AUDIO** (end)

This example contains broadcasts defined for audio group AUDIO1 as follows:

- Announcement, ringing, and silence are applied for the Attendant Queue feature (ATTQ).
- Announcement, second announcement, music, and silence are applied for Uniform Call Distribution Queue (UCDQ).

Broadcasts that are defined for audio group AUDIO2 are Announcement, ringing, music, and silence applied for feature Call Hold (CHD).

**MAP example for table AUDIO**

AUDIOKEY		ROUTES	
AUDIO1	ATTQ	(ANN Y 1 ANN1)	(SILENCE 0) \$
AUDIO1	UCDQ	(ANN N 1 ANN1) (ANN N 1 ANN2)	(MUSIC MUSIC1 6) (SILENCE 0) \$
AUDIO2	CHD	(ANN Y 1 ANN2)	(MUSIC MUSIC1 12) (SILENCE 0) \$
AUDIO1	SLQQ		(SILENCE 0) \$

**Table history**

**EUR006**

This release adds the following items to table AUDIO:

- a reference that the ETSI Call Hold feature re-uses FTRINDEX KSMOH in EUR006
- a field description for field ROUTES

**CSP02**

Added feature SLQ to the list of features in the FTRINDEX subfield, the feature descriptions, and the MAP example in CSP02.



---

**AUDPRGM**

---

**Table name**

Automatic Dial Key Program Table

**Functional description**

Table AUDPRGM is used by an operating company to define the digits datafilled on an automatic dial (AUD) key. The key to this table is a Meridian Digital Centrex (MDC) customer group name and a character string that determines what digits are translated when the AUD key is pressed.

A total of 16 feature names are allowed in table AUDPRGM. These names must be used for all customer groups, however the digits associated with the feature name can be different for each customer group.

Tuples must not be deleted from table AUDPRGM while there are Meridian business sets (MBS) with AUD keys referencing the deleted tuple.

**Datafill sequence and implications**

Table CUSTENG must be datafilled before table AUDPRGM.

**Table size**

0 to 32 767 tuples

**Datafill**

The following table lists datafill for table AUDPRGM.

**Field descriptions (Sheet 1 of 2)**

Field	Subfield or refinement	Entry	Explanation and action
AUDKEY		see subfields	<i>Automatic dial key</i> This field is the key to the table. This field consists of subfields CUSTGRP and FEATNAME.
	CUSTGRP	alphanumeric (1 to 16 characters)	<i>Customer group name</i> Enter a Meridian Digital Centrex (MDC) customer group name previously datafilled in table CUSTENG.

**AUDPRGM (end)**

**Field descriptions (Sheet 2 of 2)**

Field	Subfield or refinement	Entry	Explanation and action
AUDDIGS	FEATNAME	alphanumeric (1 to 16 characters)	<i>Feature name</i> Enter a feature or service name. A maximum of 16 feature names can be defined at any one time.
		vector of upto 30 digits, *, and #	<i>Automatic dial key digits</i> This field contains the digits that are programmed on an automatic dial (AUD) key in the customer group for the feature. Up to 30 digits are allowed.  The asterisk (*) character is allowed as the first character entered in this field, if field FEATNAME does not contain the entry STD. * is represented by the alphabetic character b in the DMS-100 switch.  The # sign is represented by the alphabetic character c.

**Datafill example**

The following example shows sample datafill for table AUDPRGM.

**MAP display example for table AUDPRGM**

	AUDKEY	AUDDIGS
POTSDATA	E911	B69

**Table history**  
**NA004**

Field AUDDIGS has been increased form 24 digits to 30 digits.

---

**AUTHCDE**

---

**Table name**

Authorization Code Table

**Functional description**

Table AUTHCDE defines the authorization codes used by various network services. This table supports Integrated Business Network (IBN) and call forwarding remote access (CFRA). Authorization codes can also be assigned to customer groups.

For IBN services, entries in this table define the authorization code and (if active) the network class of service, account option, and security digits.

If the authorization or account code last (ACR) option is datafilled in field OPTION in table CUSTHEAD and in field NCOSOPTN in table NCOS, the authorization code entered in field NCOS in table AUTHCDE cannot be used to retranslate dialed digits. Call routing is determined prior to the entry of the authorization code and calls follow that selected route if the authorization code is valid. Changing the authorization code has the sole effect of applying the code restriction level datafilled in field CRL in table NCOS to the call.

Authorization codes are not unique to a customer group. For example, customer group BNR can have the same authorization code length and numbers as customer group NTI.

For CFRA services, entries in this table define the authorization code, serving numbering plan area (SNPA), and directory number (DN) assigned to the CFRA station. CFRA-related entries cannot be datafilled or changed using table control. Entries can only be added or changed by the service order system (SERVORD) or by datafilling tables IBNFEAT or KSETFEAT.

For related information, refer to table AUTHPART.

**Datafill sequence and implications**

The following tables must be datafilled before table AUTHCDE:

- AUTHPART
- HNPACONT
- NCOS
- PSCNUM

## AUTHCDE (continued)

---

### Table size

A maximum of 1023 unique national number group plus (NNGP) values can be assigned to any IBN format authorization code in any partition. There is no limit on the number of authorization codes that can use a single unique NNGP value.

Memory is dynamically allocated for each entry in table AUTHCDE.

An authorization code with options assigned requires 22 bytes of storage.

A partition that contains authorization codes with options, requires data store memory according to the following equation:

$$\text{data store bytes} = \{ (\text{SW} \cdot 22) + (\text{SSAC} \cdot 22) \}$$

where

**SW**

is the number of field AUTHTYPE with entry SW

**SSAC**

is the number of field AUTHTYPE with entry SSAC

In addition

- the number of partitions containing options cannot exceed 32
- the number of SW, ASR, or SUPAC authorization codes cannot exceed 520 200 for each partition
- the number of SSAC authorization codes cannot exceed 65 025 for each partition

The amount of data store required to store each unique NNGP is 21 bits. The smallest block of NNGPs that can be allocated at once is 256 unique NNGPs.

Thus, the minimum amount of store is

$(21 \text{ bits} \times 256 \text{ unique entries}) = 672 \text{ bytes} + 8 \text{ bytes for indexing} = 680 \text{ bytes.}$

The maximum amount of store is

$(21 \text{ bits} \times 1024 \text{ unique entries}) = 2688 \text{ bytes} + 8 \text{ bytes for indexing} = 2696 \text{ bytes.}$

**AUTHCDE** (continued)**Datafill**

The following table lists datafill for table AUTHCDE.

**Field descriptions**

<b>Field</b>	<b>Subfield or refinement</b>	<b>Entry</b>	<b>Explanation and action</b>
AUTHPART		alphanumeric (1 to 16 characters)	<p><i>Partition name</i> This is the first part of the key to this table and must exist in table AUTHPART, field PARTNM.</p> <p>If field FORMAT is set to EXEMPT or IBN, enter the partition name assigned to the customer group.</p> <p>If field FORMAT is set to CFRA, this field is automatically datafilled.</p>
AUTHCODE		0 to 9(2 to 12 digits)	<p><i>Authorization code</i> This is the second part of the key to this table and must contain the same number of digits as defined in table AUTHPART, field LENGTH.</p> <p>If field FORMAT is set to EXEMPT or IBN, enter the authorization code for the customer group.</p> <p>If field FORMAT is set to CFRA, this field is automatically datafilled.</p>

**AUTHCDE** (continued)

**Field descriptions**

Field	Subfield or refinement	Entry	Explanation and action
INFO		see subfield	<i>Information</i> This field consists of subfield FORMAT and its refinements.
FORMAT		CFRA, EXEMPT, or IBN	<i>Format</i> Enter CFRA (call forwarding remote access) to assign the authorization code to the CFRA feature. This field and refinements SNPA and LCLDN are automatically datafilled.  Enter EXEMPT to assign the authorization code to the customer group (not usable) and datafill refinement DDMM.  Enter IBN to assign the authorization code to the customer group (usable) and datafill refinements NCOS, ACCT, SECDIGS, AUTHTYPE, and OPTIONS.  Refinements for the formats are shown on the following pages in alphabetical order by format.

**FORMAT = CFRA**

If the entry in subfield FORMAT is CFRA, refinements SNPA and LCLDN are automatically datafilled as described below.

**Field descriptions for conditional datafill**

Field	Subfield or refinement	Entry	Explanation and action
SNPA		0 to 9 (3 digits)	<i>Serving numbering plan area</i> The serving numbering plan area (SNPA) of the directory number (DN) assigned in field LCLDN is automatically datafilled.
LCLDN		0 to 9 (7 digits)	<i>Directory number</i> The DN of the CFRA station is automatically datafilled.

**AUTHCDE** (continued)**FORMAT = EXEMPT**

If the entry in subfield FORMAT is EXEMPT, datafill refinement DDMM as described below.

**Field descriptions for conditional datafill**

Field	Subfield or refinement	Entry	Explanation and action
DDMM		0 to 9 (4 digits)	<i>Day and month</i> Enter the date (day and month) the authorization code becomes exempt. For example, enter 0106 for June 1st.

**FORMAT = IBN**

If the entry in subfield FORMAT is IBN, datafill refinements NCOS, ACCT, SECDIGS, AUTHTYPE, and OPTIONS as described below.

**Field descriptions for conditional datafill**

Field	Subfield or refinement	Entry	Explanation and action
NCOS		0 to 251	<i>Network class of service</i> Enter the network class of service associated with the authorization code as previously datafilled in table NCOS.
ACCT		Y or N	<i>Account option</i> Enter Y (yes), to indicate that an account code is required. Otherwise, enter N (no).
SECDIGS		0 to 9 (1 to 4 digits) or \$	<i>Security code digits</i> If a nil security code is required, enter \$. If a security code is required, enter a security code.
AUTHTYPE		ASR SSAC SUPAC SW VOW	<i>Authorization code type</i> Enter one of the following authorization code types: <ul style="list-style-type: none"> <li>• ASR (automatic set relocation)</li> <li>• SSAC (station specific)</li> <li>• SUPAC (super)</li> <li>• SW (system wide)</li> <li>• VOW (virtual office worker)</li> </ul>

**AUTHCODE** (continued)**Field descriptions for conditional datafill**

<b>Field</b>	<b>Subfield or refinement</b>	<b>Entry</b>	<b>Explanation and action</b>
OPTIONS		see subfield	<i>Options</i> This field consists of subfield OPTION.
	OPTION	CUSTGRP HOTLINE NNGP PIN PSC or TONEBURST	<i>Option</i> Enter up to eight options and refinements. If less than eight options are required, end the list with a \$ (dollar sign). Separate each option and its refinement with a single space. Datafill as many tuples as required to complete the list of options and refinements. If the option is not provided, no input for that option is required.  Enter CUSTGRP for customer group and datafill refinement CUSTGRP.  Enter HOTLINE for hotline and datafill refinement HOTLN_NUM.  Enter NNGP for national number group plus and datafill refinement NNGP_DIGITS.  Enter PIN for personal identification number and datafill refinement PINSTATS.  Enter PSC for private speed call and datafill refinement PSC_IDX.  Enter TONEBURST to specify that tone burst on answer is required. Tone burst on answer is provided on calls to indicate to the subscriber that the call has been answered and that authcode digits can be entered.
	CUSTGRP	alphanumeric (1 to 16 characters)	<i>Customer group</i> If the entry in subfield OPTION is CUSTGRP, datafill this refinement. Enter the customer group name as previously datafilled in table CUSTGRP.
	HOTLN_NUM	0 to 9 (1 to 10 digits)	<i>Hotline number</i> If the entry in subfield OPTION is HOTLINE, datafill this refinement. Enter the hotline number associated with this AUTHCODE.



**AUTHCODE** (continued)**Field descriptions for conditional datafill**

<b>Field</b>	<b>Subfield or refinement</b>	<b>Entry</b>	<b>Explanation and action</b>
	NNGP_DIGITS	00000 to 99999	<i>National number group plus digits</i> If the entry in subfield OPTION is NNGP, datafill this refinement. Enter the NNGP number. This number is compared with the digits received in a BTUP initial address message. The validation of the datafilled digits with the received digits determines if the call is allowed to proceed.
	PINSTATS	OPTBYREG or REQUIRED	<i>Personal identification number status</i> Enter the type of status given to the authcode.  If an authcode is always required, enter REQUIRED and datafill refinement PINSEL.  If an authcode is required based on the region code, enter OPTBYREG and datafill refinements REGNCODE and PINSEL.
	REGNCODE	0 to 2047	<i>Region code</i> If the entry in refinement PINSTATS is OPTBYREG, enter the region code.
	PINSEL	SINGLE or MULTIPLE	<i>Personal identification number selector</i> Enter SINGLE if only one PIN is associated with this AUTHCODE and datafill refinement PINDIGS. Enter MULTIPLE if more than one PIN is associated with this AUTHCODE and datafill refinement PININDEX.
	PINDIGS	0000 to 9999	<i>Personal identification number digits</i> If the entry in refinement PINSEL is SINGLE, enter the PIN digits.

**AUTHCDE** (end)

**Field descriptions for conditional datafill**

Field	Subfield or refinement	Entry	Explanation and action
	PININDEX	0 to 8191	<i>Personal identification number index</i> If the entry in refinement PINSEL is MULTIPLE, enter the PIN index number. Each index can be associated with 100 PINs or 1000 PINs, depending on the index value.
	PSC_IDX	0 to 4999	<i>Private speed call index</i> If the entry in subfield OPTION is PSC, enter the same index number as datafilled in field PSC_IDX in table PSCNUM. This number associates an AUTHCODE with a private speed call list.

**Datafill example**

The following example shows sample datafill for table AUTHCDE.

**MAP display example for table AUTHCDE**

AUTHPART	AUTHCODE	INFO
BNR	12345678	IBN 34 Y 555 SSAC (PIN REQUIRED SINGLE 63) (PSC 4) \$

**Table history**

**SN07 (DMS)**

Added option VOW (virtual office work) as AUTHTYPE in FORMAT = IBN for feature A00002011.

**EUR004**

Revised table size information.

**UK002**

Option TONEBURST was added.

**BCS35**

Option NNGP and refinements were added.

**AUTHGRP****Table name**

Authorization Code Group Table

**Functional description**

Table AUTHGRP allows a group of directory numbers to be given authorization code screening service. A tuple in this table represents a directory number group. Each tuple contains an indication (Y or N) of whether validation of the authorization codes is to occur and the size of the authorization codes (in digits) for the group. If validation is to occur, the tuple further provides a list of code ranges which are valid for the group.

A default tuple, key 0, is provided and cannot be altered or deleted. This is a nil tuple, and references to it from table DNSCRN indicate that the directory number is not eligible for authorization code screening service.

**Datafill sequence and implications**

Table AUTHGRP. must be datafilled before its index can be used in table DNSCRN.

There is no requirement to datafill other tables prior to table AUTHGRP..

**Table size**

1 to 32767 tuples

Store is dynamically allocated and deallocated as needed.

**Datafill**

The following table lists datafill for table AUTHGRP.

**Field descriptions (Sheet 1 of 3)**

Field	Subfield or refinement	Entry	Explanation and action
AUTHKEY		see subfield IDX	Authorization key. This field is the key into the table and consists of subfield IDX. This key field is indexed from field AUTHGRP in table DNSCRN when field ATTROPTS = TOPSDB.
	IDX	0 to 32766	Index into this table.
AUTHVALA		see subfield VALIDATE	Authorization validation area. This field consists of subfield VALIDATE.

**AUTHGRP** (continued)**Field descriptions (Sheet 2 of 3)**

<b>Field</b>	<b>Subfield or refinement</b>	<b>Entry</b>	<b>Explanation and action</b>
	VALIDATE	Y or N	Validate. Indicate whether authorization codes for this directory number group are to be validated against a list of code ranges in subfield AUTH_CODES that follows. If validation is required, enter Y and datafill refinements CODESIZE and AUTH_CODES. Otherwise, if no validation is required, enter N and no further datafill is required.
	CODESIZE	2 to 8	Code size. If VALIDATE = Y, datafill this field. Enter the number of digits for the authorization codes (given in following subfield AUTH_CODES) for this group.
	AUTHFORM	see subfield FORMAT	Authorization format. This field consists of subfield FORMAT.
	FORMAT	RANGE or DISTINCT	<p>Format. This field indicates where the authorization codes are datafilled:</p> <ul style="list-style-type: none"> <li>• RANGE - Codes are datafilled as ranges in field AUTH_CODE of this table (AUTHGRP).</li> <li>• DISTINCT - Codes are datafilled as non-consecutive unique values in table AUTHSGRP.</li> </ul> <p>If FORMAT = RANGE, datafill subfield AUTH_CODES. If FORMAT = DISTINCT, no further datafill is required.</p>

**AUTHGRP** (continued)**Field descriptions (Sheet 3 of 3)**

Field	Subfield or refinement	Entry	Explanation and action
	AUTH_CODES	see subfields MIN and MAX.	<p>Authorization codes. This subfield is only populated if VALIDATE = Y. Enter up to 10 pairs of MIN and MAX values of authorization code ranges for validation.</p> <p>MIN and MAX range from 0 to `n' 9's where `n' is the value of the CODESIZE field. For example, if CODESIZE = 5, then MIN and MAX may be any value between 0 and 99,999. Values entered with less than `n' digits are considered to have prefixed `0's. For example, if `n' is 5 and "478" is entered, the value is considered to be "00478". The MAX value of a pair must be equal to or greater than the MIN value.</p> <p>Pairs should not overlap another code pair and should progress from lower values to higher values. Overlapping pairs are allowed, but not advised.</p>
	MIN	0 to `n' 9s (where `n' = CODESIZE)	Minimum. Enter the authorization code range minimum value. See comments under subfield AUTH_CODES.
	MAX	0 to `n' 9s (where `n' = CODESIZE)	Maximum. Enter the authorization code range maximum value. See comments under subfield AUTH_CODES.

**Datafill example**

The following example shows sample datafill for table AUTHGRP.

**MAP display example for table AUTHGRP**

```

AUTHKEY AUTHVALA
-----
0          N
14         Y  4  RANGE  (400 799) (2200 2299) (6000 6521)$
22         Y  3  DISTINCT
27         Y  3  RANGE  (100 200) (300 400) (500 500) (600 601)$
32         Y  2  DISTINCT
33         Y  8  DISTINCT

```

## AUTHGRP (continued)

In tuple 14 above, codes in the range (400 799) are considered to be (0400 0799).

Tuple 0 shown above is a default entry and cannot be altered or deleted. This is a nil tuple, and references to it from table DNSCRN indicate that the directory number is not eligible for authorization code screening service.

### Error messages

The following error messages apply to table AUTHGRP.

#### Error messages for table AUTHGRP (Sheet 1 of 2)

Error message	Explanation and action
Tuple 14 is referenced by table DNSCRN.	Table AUTHGRP must be datafilled before its index can be used in table DNSCRN. If a tuple in AUTHGRP is referenced in DNSCRN and a delete operation is attempted in AUTHGRP, an error message is displayed and the operation is denied.
TUPLE 0 CANNOT BE DELETED OR CHANGED	An attempt is made to delete or change the default tuple for table AUTHGRP.
IF VALIDATE IS Y YOU MUST ENTER AUTH CODES	Field VALIDATE is set to Y but invalid ranges are entered for field AUTH_CODES. Change VALIDATE from Y to N and enter valid ranges for AUTH_CODES.
AUTHORIZATION CODE SIZE MUST BE 2, 3, OR 4.	An invalid value is entered for field CODESIZE. The valid range is 2-4.
WARNING! DUPLICATE TUPLE. THIS DATA IS PRESENT IN TUPLE n	The data entered is duplicated in another tuple.  If a tuple is associated with tuples in table AUTHSGRP or a tuple in table DNSCRN, a delete operation is not allowed on the tuple in AUTHGRP. The operation is denied and an error message is displayed. All of the associated tuples in AUTHSGRP and DNSCRN must be deleted before this operation is permitted.

**AUTHGRP** (end)**Error messages for table AUTHGRP (Sheet 2 of 2)**

Error message	Explanation and action
	<p>If a change operation is attempted on the FORMAT field from DISTINCT to RANGE, all of the associated tuples in table AUTHSGRP must be deleted before the change is permitted.</p> <p>If a change operation is attempted on the FORMAT field from RANGE to DISTINCT, a warning message is displayed indicating that all of the authcode range information will be lost once the change is completed.</p> <p>If a change operation is attempted on the CODESIZE field in which the tuple is associated with tuple(s) in table AUTHSGRP, the operation is denied if the new CODESIZE is less than the existing CODESIZE.</p> <p>If a change operation is attempted on the VALIDATE field in which there are associated tuples datafilled in table AUTHSGRP, the operation is denied.</p>

**Table history****NA006**

Fields AUTHVALA and CODESIZE are changed, and field FORMAT is added by feature AF6340 in functionality TOPS Authorization code Billing, ABS00013.

**NA005**

Table introduced by functionality TOPS Authorization Code Billing, ABS00013.

## AUTHPART

---

### Table name

Authorization Partition Table

### Functional description

Authorization code tables are provided in switching units with feature package NTX103AA (IBN - SMDR Enhanced).

Authorization codes are sets of digits dialed by a user to

- identify an authorized user of the network and exclude unauthorized users
- assign a network class of service (NCOS) designation to a customer rather than to a station or incoming trunk group.

An NCOS is assigned to each authorization code. The NCOS specifies the code restriction level (CRL), line screening code (LSC), and so on, that is applicable to any number the authorization code user subsequently dials.

If a valid authorization code is dialed, the attributes of the authorization code (not the attributes associated with the line or incoming trunk group) prevail for the call. See table NCOS for further information.

Authorization codes are recorded in a Station Message Detail Recording (SMDR) record for billing purposes, analysis, and so on.

Authorization codes can be from 2 to 14 digits in length and consist of two parts:

- A fixed length authorization code for each customer group. The code can be from two to ten digits in length.
- A security code. This is optional for each authorization code. The code can be from zero to four digits in length.

If security digits are used, they are always entered after the authorization code. Security digits are transparent to the user and serve to make authorization codes more secure by varying the total authorization code digit length for a customer group.

Specifying the authorization code type, in field AUTHTYPE, prevents users from randomly accessing authorization codes and abusing calling privileges. Users are able to access privileges provided by an authorization code only after the switch software verifies the authorization code against the particular station the code originated from.



---

**AUTHPART** (continued)

---

The three types of authorization codes are:

- Station-specific authorization codes (SSAC)
  - SSACs are valid only if accessed from the station to which they are assigned.
- Super authorization code (SUPAC)
  - SUPACs provide the capability for accessing privileges provided by an authorization code from any station. For example, a student requesting access from any station, and agreeing to pay the monthly account, even if unfamiliar numbers appear on the station used.
- System-wide authorization codes (SWAC)
  - SWACs are necessary for users (for example, maintenance personnel or campus contractors) that, due to the nature of their jobs, need to access long distance services from stations in public areas. SWACs can be accessed from all stations not assigned SSAC.

If the account code is required, the DMS prompts the user for an account code based on the following information:

- the attributes of the authorization code
- the combined attributes of the authorization code and the called number (translation result)

If a customer group requires an authorization code, it can be a combined authorization and account code. In this case, the code applies to the entire customer group. A combined authorization and account field must be datafilled at the customer group level if this option is required.

For combined authorization and account codes, the following rules apply:

- The authorization code, including security digits, must precede the account code; for example, authorization code + security code + account code
- DMS-100 does not prompt separately for the account code.
- DMS-100 validates the authorization code portion. The account code is checked only for the correct number of digits.
- The maximum number of digits is 14.

If an attendant is required to validate authorization codes, a feature key and lamp must be assigned to a validation key on each console used for validation purposes. See table ATTCONS for further details.

## **AUTHPART** (continued)

---

If an attendant is to input an authorization code when extending a call, a separate feature key and lamp must be assigned to this function on the console.

To conserve keys on the console, both of the above options can be invoked through a wild card key. If the wild card key is used, a two-digit code must be assigned to each of these options.

Table AUTHPART defines the partition in the authorization code database that authorization codes are stored for a customer group or a Call Forwarding-Remote Access (CFRA) line feature.

The authorization code is fixed in length on a customer group basis.

There can only be one entry for the CFRA partition.

Tables AUTHPART and AUTHCDE are interrelated tables supporting the partitioned authorization code database. A customer that has a partition to store authorization codes with properties (length, format, and maximum size) must first define these properties in table AUTHPART. Once a partition is created, the authorization codes and attributes can be added to table AUTHCDE. Removing a partition in table AUTHPART requires all authorization codes within that partition to be removed from table AUTHCDE.

Once an entry is made in table AUTHCDE, table SSAC must also be datafilled.

To provide the authorization code option to a customer group, the customer group entry in table CUSTGRP must be datafilled to include the authorization code option.

### **Datafill sequence and implications**

The following tables must be datafilled before table AUTHPART:

- AUTHCDE
- CUSTHEAD
- DATAOWNER

### **Table size**

0 to 256 tuples

Memory is dynamically allocated for table AUTHPART.

**AUTHPART** (continued)**Datafill**

The following table lists datafill for table AUTHPART.

**Field descriptions**

Field	Subfield or refinement	Entry	Explanation and action
PARTNM		alphanumeric (1 to 16 characters)	<i>Partition name</i> Enter the partition name for the customer group or for the CFRA lines. This is the key of table AUTHPART.
FORMAT		CFRAEXEMP Tor IBN	<i>Format</i> Enter CFRA if the authorization code is assigned for the CFRA feature and is usable. Enter EXEMPT if ACs are not used. Enter IBN if the authorization code is assigned to the customer group and is usable.
LENGTH		2 to 10	<i>Length of authorization code</i> Enter the number of digits in each authorization code in the partition.
MAXSIZE		0 to 1000000	<i>Maximum size</i> Enter the maximum allowable number of authorization codes that can be accommodated in the partition.  <b>Note:</b> The maximum number of authorization codes that can be entered depends on the number of digits entered in field LENGTH. For example, if the entry in field length is 3, the maximum number of codes is 999  Entries outside the entry range are invalid.

**Datafill example**

The following example shows sample datafill for table AUTHPART.

In the example, three customer groups (BNR, NTI, CFRAPART, and HURLEYS) exist.

For customer group BNR, the number of digits in the authorization code is 8 and the total number of authorization codes that can be accommodated in the partition is 100.

---

## AUTHPART (end)

---

For customer group NTI, the number of digits in the authorization code is 8 and the total number of authorization codes that can be accommodated in the partition is 200.

For customer group HURLEYS, the number of digits in the authorization code is 5 and the total number of authorization codes that can be accommodated in the partition is 50.

The partition name for CFRA lines is CFRAPART. The total number of of authorization codes that can be accommodated in the partition is 100 and the number of digits in the personal identification number (PIN) is 4.

### MAP display example for table AUTHPART

PARTNM	FORMAT	LENGTH	MAXSIZE
BNR	IBN	8	100
NTI	IBN	8	200
HURLEYS	IBN	5	50
CFRAPART	CFRA	4	100

### Table history BCS36

Upgrade table to meet BCS35 writing standards

---

**AUTHSGRP**

---

**Table name**

Authorization Codes Group Table

**Functional description**

This table contains the distinct authorization codes associated with a DN group when the FORMAT field in table AUTHGRP is datafilled with the `DISTINCT' option. In table AUTHSGRP, field AUTHINFO is a multi-part key which contains the AUTHIDX field and the AUTHCODE field. Each tuple is a distinct authorization code associated with a DN group. The AUTHIDX field associates the authorization code with a DN group. The distinct authorization code is specified in the AUTHCODE field and is of the length specified in the CODESIZE field in table AUTHGRP. The AUTHSGRP table can only contain tuples for the DN group specified as `DISTINCT' in table AUTHGRP.

**Datafill sequence and implications**

Table AUTHGRP must be datafilled before table AUTHSGRP.

**Table size**

0 to 2,097,024 tuples

**Datafill**

The following table lists datafill for table AUTHSGRP.

**Field descriptions (Sheet 1 of 2)**

Field	Subfield or refinement	Entry	Explanation and action
AUTHINFO		see subfields	Authorization information. This is the key into the table and consists of subfields AUTHIDX and AUTHCODE. This table is only used when table AUTHGRP field FORMAT = DISTINCT.

## AUTHGRP (continued)

### Field descriptions (Sheet 2 of 2)

Field	Subfield or refinement	Entry	Explanation and action
	AUTHIDX	0 to 32766	Authorization index. This field associates a distinct authorization code with a DN group. This field directly maps to the IDX field in table AUTHGRP.
	AUTHCODE	digits (number of digits is in field CODESIZE of table AUTHGRP)	Authorization code. This field contains the distinct authorization code associated with a DN group. The CODESIZE field in table AUTHGRP specifies the number of digits in this AUTHCODE field. If the number of digits in this field is less than the specified length in field CODESIZE, this AUTHCODE entry is prefixed internally with zeros.

### Datafill example

The following example shows sample datafill for table AUTHGRP.

### MAP display example for table AUTHGRP

```

AUTHINFO
-----
22  111
22  345
22  783
32  1
32  45
33  345912
33  23910384
33  49013895
33  90382819
    
```

**AUTHSGRP** (end)**Error messages**

The following error messages apply to table AUTHSGRP.

**Error messages for table AUTHSGRP**

Error message	Explanation and action
	<p>If an add operation is attempted on table AUTHSGRP without an associated DN group in table AUTHGRP or if the associated DN group is datafilled in table AUTHGRP with field FORMAT = RANGE to indicate ranges of authorization codes, the operation is denied and this error message is displayed.</p> <p>If a delete operation is being performed on the last authorization code for a DN group and an associated tuple in DNSCRN still exists, a warning message is displayed. The operation is allowed; however, the subscriber will be routed to REORDER treatment after entering an authorization code because there are no datafilled authorization codes to validate against.</p>

**Table history****NA006**

This table was created by feature AF6340 in functionality TOPS Authorization code Billing, ABS00013.

**Supplementary information**

None

---

## AUTOEXEC

---

### Table name

Automatic File-execution Table

### Functional description

The autoexec user function uses table AUTOEXEC as a look-up table. This condition accesses the autologon time and the file name for the automatic run of Support Operating System (SOS) executable files (exec). Table AUTOEXEC automatically transfers the SOS exec and the schedule information to a new BCS load during one-night process (ONP) upgrade.

### Datafill sequence and meaning

You do not need to enter data in other tables before you enter data in table AUTOEXEC.

### Table size

1 tuple

### Datafill

The following table contains datafill for table AUTOEXEC.

#### Field descriptions (Sheet 1 of 2)

Field	Subfield or refinement	Entry	Explanation and action
AEKEY		AUTOEXEC	<i>AUTOEXEC key.</i> This field is the key to table AUTOEXEC. You can only enter one tuple.  Enter AUTOEXEC.  The default value is AUTOEXEC.
TIME		see subfields	<i>Start time.</i> This field specifies the time when the autoexec function is logged on and the contents of the SOS exec specified in field EXEC are executed.  This field contains subfields HOUR and MINUTE.
	HOUR	0 to 23	<i>Hour.</i> Enter the starting hour for the system to begin the autoexec function.  The default value is 3.



**AUTOEXEC** (continued)

## Field descriptions (Sheet 2 of 2)

Field	Subfield or refinement	Entry	Explanation and action
DURATION	MINUTE	0 to 59	<p><i>Minute.</i> Enter the starting minute of the starting hour for the system to begin the autoexec function.</p> <p>The default value is 30.</p>
		1 to 240	<p><i>Duration.</i> Enter the duration in 5 min increases that the autoexec function can log on and execute a file before being forced out.</p> <p>The default value is 55.</p> <p><b>Note:</b> The field can be set in increases of 1 min. The system reads this entry to the nearest 5 min. For example, the system reads an entry of 7 as 5 min.</p>
USER		alphanumeric (1 to 16 characters)	<p><i>User.</i> Enter the user identification (userID) of the user that schedules the autoexec function. This action makes sure that the autoexec function always uses the userIDs command class, language, and stack. This function uses these commands when the function executes the exec.</p> <p><b>Note:</b> If the user cannot be determined during dump and restore, or the userID is not correct, the default value becomes ADMIN.</p>
EXEC		alphanumeric (1 to 16 characters)	<p><i>Executable file name.</i> Enter the name of the file in the system file device (SFDEV) that contains the SOS execs that the autoexec function runs.</p> <p>The default value is Undefined_File.</p> <p><b>Note:</b> This file must be in the SFDEV. To avoid problems with other functions, the name chosen for the file must provide a key to the purpose. The name chosen must provide the name of the person to contact regarding the file.</p>

**Datafill example**

Sample datafill for table AUTOEXEC appears in the following example.

## AUTOEXEC (end)

---

### MAP example for table AUTOEXEC

AEKEY	TIME	DURATION	USER	EXEC
AUTOEXEC	3	30	55	None Undefined_File

### Table history

#### BCS35

Table AUTOEXEC was introduced in BCS35.

#### BCS36

Added note to field DURATION in BCS36.

### Additional information

This section provides information on dump and restore precautions when you enter data in table AUTOEXEC. This table contains cautions for the SOS execs for table AUTOEXEC.

#### Dump and restore

If the file is in the system file device (SFDEV), the SOS exec copies during ONP. If the file does not exist or the file does not copy, warning messages are output and the ONP continues.

*Note:* The SOS exec must be left in the SFDEV following the ONP to enable the autoexec function.

#### SOS execs

The SOS execs cannot be scheduled in a method that degrades the primary functions of the switch. The operating company must make sure that the autoexec function does not perform an SOS exec. This SOS exec must not conflict with DMS routines in the areas of real-time operation, call processing, or internal maintenance processes. The operating company must verify the completion of the autolog activity. The autoexec function provides a method to schedule the run of SOS execs. The autoexec function does not make sure that every autologon request is successful. The autoexec function does not make sure that the SOS exec runs correctly.

---

**AUTOHIB**

---

**Table name**

Autopatcher Uninhibited Log Reports Table

**Functional description**

Table AUTOHIB represents the log reports that Autopatcher does not inhibit.

**Datafill sequence and meaning**

You do not need to enter data in other tables before you enter data in table AUTOHIB.

**Table size**

Memory for this table is allocated dynamically.

**Datafill**

Datafill for table AUTOHIB appears in the following table.

**Field descriptions**

Field	Subfield or refinement	Entry	Explanation and action
LOGNAME		alphanumeric (a maximum of 8 characters)	<i>Log group name.</i> Enter the log group name, for example PCH or EXT, and so on.
LOGNUM		-1 to 999	<i>Log number.</i> Enter the log number that associates with the log group. Value -1 specifies every log in a specified log group.  The default value for this field is 0 (zero).

**Datafill example**

Sample datafill for table AUTOHIB appears in the following example.

## **AUTOHIB** (end)

---

### **MAP example for table AUTOHIB**

LOGNAME	LOGNUM
MM	100
MM	101
CM	103
CM	111
AUDT	101
AUDT	102

### **Table history** **BCS36**

Table AUTOHIB was introduced in BCS36.

---

**AUTOTAB**

---

**Table name**

Automated Table Audit Table

**Functional description**

Table AUTOTAB stores the scheduling information for the automated table audit (tabaudit). Each tuple contains a time frame in which the automated tabaudit verifies specified DMS table data integrity.

Enter data in table AUTOTAB through the command interpreter (CI) command TABAUDIT, subcommand TIMEFRAME, at the AUTOTABAUDIT (AUTO) level of the switch.

See table DART for additional information.

**Datafill sequence and meaning**

You must enter data in table DART before you enter data in table AUTOTAB.

**Table size**

8 tuples

You cannot increase or decrease the size of table AUTOTAB.

**Datafill**

Datafill for table AUTOTAB appears in the following table.

**Field descriptions (Sheet 1 of 3)**

Field	Subfield or refinement	Entry	Explanation and action
SCHEDULE		see subfield	<i>Schedule</i> . This field is the key to the table and contains subfield AUTO_TABAUDIT_KEY.
	AUTO_TAB - AUDIT_KEY	0 to 7	<i>Automated table audit key</i> . This field is the key to the table. Enter the number of the schedule.
TIMEFRAME		see subfield	<i>TimeFrame</i> . This field contains subfield OPTIONS.

**AUTOTAB** (continued)

## Field descriptions (Sheet 2 of 3)

Field	Subfield or refinement	Entry	Explanation and action
	OPTIONS	SINGLE	<p><i>Single.</i> This entry allows users to select a single start time, start date, stop time, and stop date for automated TABAUDIT processing activities.</p> <p>The SINGLE entry has the following values: INITTIME, INITDATE, STOPTIME and STOPDATE</p>
		DAILY	<p><i>Daily.</i> This entry allows users to select a daily start time and stop time for automated TABAUDIT processing activities.</p> <p>The DAILY entry has the following values: INITTIME and STOPTIME</p>
		WEEKLY	<p><i>Weekly.</i> This entry allows users to select a weekly start time, start day, stop time, and stop day for automated TABAUDIT processing activities.</p> <p>The WEEKLY entry has the following values: INITTIME, INITDAY, STOPTIME, and STOPDAY</p>
		MONTHLY	<p><i>Monthly.</i> This entry allows users to select the start time, start date, stop time, and stop date for automated TABAUDIT processing activities.</p> <p>The MONTHLY entry has the following values: INITTIME, INITDATE, STOPTIME, and STOPDATE</p>
	INITDATE	10 alphanumeric characters	<p><i>Initiate date.</i> Enter the date when the automated table audit (TABAUDIT) begins to verify selected tables in the format YYYY:MM:DD. For example, 1993:11:22.</p>
	INITTIME	5 alphanumeric characters	<p><i>Initiate time.</i> Enter the time on the initial date (INITDATE) that automated TABAUDIT begins to verify selected tables in the format HH:MM. For example, 21:00.</p>

**AUTOTAB** (continued)

## Field descriptions (Sheet 3 of 3)

Field	Subfield or refinement	Entry	Explanation and action
	INITDAY	SUN, MON, TUE, WED, THU, FRI, or SAT	<i>Initiate day.</i> Enter the day that automated TABAUDIT begins to verify selected tables with one of the above entries. For example, FRI.
	STOPDATE	10 alphanumeric characters	<i>Stop date.</i> Enter the date that the automated TABAUDIT stops the verification selected tables in the format YYYY:MM:DD. For example, 1993:11:22.
	STOPTIME	5 alphanumeric characters	<i>Stop time.</i> Enter the time on the initial date (INITDATE) that automated TABAUDIT stops the verification selected tables in the format HH:MM, for example, 21:36.
	STOPDAY	SUN, MON, TUE, WED, THU, FRI, or SAT	<i>Stop day.</i> Enter the day that the automated TABAUDIT stops the verification selected tables with one of the entries. For example, FRI.

**Datafill example**

Sample datafill for table AUTOTAB appears in the following example.

**MAP example for table AUTOTAB**

SCHEDULE		TIMEFRAME			
0	SINGLE	18:00	1996:07:30	19:00	1996:07:30
1	DAILY	19:30	20:30		
2	WEEKLY	21:30	WED	01:30	THU
3	MONTHLY	16:00	30	17:00	31

**Table history**  
**BASE08**

Field TIMEFRAME was added to the table. Subfield OPTIONS was added to the table. Entries SINGLE, DAILY, WEEKLY, and MONTHLY were added

## **AUTOTAB** (end)

---

to the OPTIONS subfield. Entries INITDATE, INITTIME, INITDAY, STOPDATE, STOPTIME, and STOPDAY were added. A new MAP display was added. These entries were added in BASE08.

### **BCS36**

Table AUTOTAB was introduced in BCS36.

### **Additional information**

This section provides information on dump and restore procedures for table AUTOTAB.

#### **Dump and restore**

Normal dump and restore procedures apply.



---

**BAGNAME**

---

**Table name**

Billing Agreement Group Name

**Functional description**

Table BAGNAME defines billing agreement group names. These groups provide a way to arrange SPIDs and, or CICs that have the same billing agreements. The billing agreement group names are used as part of the index into the agreement tables, BNSAGRMT and CCVAGRMT.

**Datafill sequence and meaning**

Enter datafill into table BAGNAME before the following table

- BNSAGRMT
- CCVAGRMT
- SPIDDB
- TOPEACAR
- TOPSPARM

**Table size**

0 to 2048 tuples.

**Datafill**

The table that follows lists datafill for table BAGNAME.

**Field descriptions**

Field	Subfield	Entry	Explanation and action
BAGNAME	N/A	A billing agreement group name of up to 16 characters	Billing agreement group name. This field defines a billing agreement group name associated with the originating party. For an LEC call, this group name is associated with an SPID in table SPIDDB. For a carrier call, this group name is associated with a CIC in table TOPEACAR. This group name is used as part of the index into the agreement tables, CCVAGRMT and BNSAGRMT.

**Datafill example**

The figure that follows shows sample datafill for table BAGNAME.

## **BAGNAME** (end)

---

### **MAP example for table BAGNAME**

BAGNAME

-----  
OPRCVGRP

OPRBNSGRP

LECCVGRP

LECBNSGRP

### **Table history**

#### **TOPS13**

Table created by feature 59011929 in functionality Screening for Billing Agreement, UNBN0007.

### **Additional information**

None.

**BANASYM****Table name**

Ban Numbers from Asymmetric Switching Table

**Functional description**

Table BANASYM allows operating company personnel to datafill specified numbers exempt from asymmetrical switching. An example of an exemption is a call not expected to return an answer signal.

Interrupt the speech path to prevent false use of a connection through electrical suppression of the answer signal at the terminating telephone set. Interrupt the speech path between the time that the address digits were sent and an answer signal was received. If you interrupt the speech path in the forward direction, any call progress or comfort tones are audible to the originating subscriber. Two-way communication is not possible before answer. This type of one-way switching is asymmetric. Switching with two-way transmission is symmetric.

**Datafill sequence and meaning**

You do not need to enter data in other tables before you enter data in table BANASYM.

**Table size**

0 to an unlimited number of tuples

**Datafill**

Datafill for table BANASYM appears in the following table.

**Field descriptions**

Field	Subfield or refinement	Entry	Explanation and action
DNIDX		numeric (a maximum of 18 digits)	<i>Digitator table key.</i> Enter the country code and national number. Perform standard symmetric switching on a call if you enter the directory number in this table. If you enter STD (standard) or any other entry in table TRKGRP does not affect this condition.

**Datafill example**

An example of datafill for table BANASYM appears in the following table.

**BANASYM** (end)

---

**MAP example for table BANASYM**

DNIDX
180023895426159612

---

**BANDSETS**

---

**Table name**

Band Sets Table

**Functional description**

Table BANDSETS groups bands together to form allowable calling areas. The tuples in this table are assigned to a symbolic key rather than serving numbering plan area (SNPA) codes. A bandset can then be assigned to an enhanced wide area telephone service (WATS) line to define its allowable calling area using a particular carrier.

Table WATSBAND allows the definition of calling zones (or bands) as they pertain to NPA codes within certain geographical areas.

Table BANDSETS combines bands into groups which are assigned to customer defined symbolic keys. The symbolic keys can then be assigned to WATS access lines much like a line attribute index. The BANDSETS key defines what set of bands a given line can potentially dial.

**Datafill sequence and implications**

There is no requirement to datafill other tables prior to table BANDSETS.

**Table size**

0 to 1024 tuples

**Datafill**

The following table lists datafill for table BANDSETS.

**Field descriptions**

Field	Subfield or refinement	Entry	Explanation and action
BANDSET		1 to 8 characters	<i>Bandset</i> Enter the unique key which defines the allowable calling area.
BANDS		numeric sets of up to 127 bands with values 0 to 126	<i>Bands</i> Enter the set of bands that are grouped together as a vector. This vector determines the WATS calling area assigned to the key.

**Datafill example**

The following example shows sample datafill for table BANDSETS.

**BANDSETS** (end)

---

The example table provides the capability to group bands into a defined calling area.

In the first tuple INTRASTA consists of bands 0, 8, and 9.

In the second tuple INTERSTA consists of bands 1, 2, 3, 4, 5, and 6.

**MAP display example for table BANDSETS**

BANDSET	BANDS
INTRASTA	( 0) ( 8) ( 9)\$
INTERSTA	( 1) ( 2) ( 3) ( 4) ( 5) ( 6)\$

---

**BCCODES**

---

**Table name**

Bellcore Codes Table

**Functional description**

Table BCCODE is used in Bellcore switching offices for automatic message accounting (AMA). Capability is provided to generate AMA records solely because of studies.

Refer to the following NTPs for a description of the various types of studies supported by the DMS switch:

- *Bellcore Format Automated Message Accounting (AMA) Maintenance Guide*
- *Translations Guide*
- *Advanced Maintenance Guide*

A network completion study is the office-wide recording of all calls of a specified call code. This recording includes answered and unanswered calls for the call code being studied. Table BCCODES determines which Bellcore call codes are recorded for the network completion study.

The tuples in table BCCODES are keyed by the call type. Call codes are associated with call types by placing the call code (for example, 006) into the appropriate call type required (for example, TOLL).

In addition, the corresponding tuples for HIGHREV, UNANS\_LOCAL, UNANS\_TOLL, or UNANS\_TOPS must be set to ON in table AMAOPTS. The corresponding tuple for AIN in table BCCODES, tuple UNANS\_AIN, in table AMAOPTS must be set to ON.

**ATTENTION**

Calls to Tops Service Functions, such as calls to Directory Assistance and Intercept operator positions, are ALWAYS considered UNANSWERED calls. Deleting the call codes for these functions from BCCODES causes call records for these functions NOT to be written.

**Note:** All equal access (EA) calls, answered and unanswered, generate AMA records. In addition, if the EA calls have line usage studies applied, the study indicator of the record generated reflects the type of study assigned to the line.

## **BCCODES** (continued)

---

The recording of Bellcore AMA records is as follows:

- The call code of the AMA record is determined by the attributes of the originating and terminating agent.
- In table AMAOPTS, when option HIGHREV is set to ON, the following conditions apply:
  - All billing is suppressed and only the answered calls associated with the call codes found against call type HIGHREV in table BCCODES are recorded.
  - If the call code is not found against call type HIGHREV in table BCCODES the call record is not written.
  - If the call is unanswered and option HIGHREV in table AMAOPTS is set to ON, no records are generated. Unanswered calls are only recorded when the HIGHREV option is set to OFF in table AMAOPTS.
- In table AMAOPTS, when option HIGHREV is set to OFF and the call is not answered, options UNANS\_LOCAL, UNANS\_TOLL, and UNANS\_TOPS in table AMAOPTS determine whether the non-EA call record is written. These conditions are explained as follows:
  - If option UNANS\_LOCAL is set to ON and the call code is found against call type LOCAL in table BCCODES, the unanswered call record is written. The study indicator field of the record reflects 'Network Completion Study'.  
If the call code is not found against call type LOCAL in table BCCODES, the unanswered call record is not written.
  - If option UNANS\_TOLL is set to ON in table AMAOPTS and the call code is found against call type TOLL in table BCCODES, the unanswered call record is written. The study indicator field of the record reflects 'Network Completion Study'.  
If the call code is not found against call type TOLL in table BCCODES, the unanswered call record is not written.
  - If option UNANS\_TOPS is set to ON and the call code is found against call type TOPS in table BCCODES, the call record is written. The study indicator field of the record reflects 'Network Completion Study'.



---

**BCCODES** (continued)

---

**ATTENTION**

Calls to Tops Service Functions, such as calls to Directory Assistance and Intercept operator positions, are **ALWAYS** considered UNANSWERED calls. Deleting the call codes for these functions from BCCODES causes call records for these functions **NOT** to be written.

If the call code is not found against call type TOPS in table BCCODES, the unanswered call record is not written.

- If options UNANS\_LOCAL, UNANS\_TOLL, and UNANS\_TOPS are all set to ON in table AMAOPTS, and the call code is found against either call type LOCAL, TOLL, or TOPS in table BCCODES, the unanswered call record is written. The study indicator field of the record reflects 'Network Completion Study'.
- If options UNANS\_LOCAL, UNANS\_TOLL, and UNANS\_TOPS are all set to OFF, unanswered call records are not written.

The number of call type codes that can be datafilled in the CODES field is increased from 32 to 46.

**Note:** All EA calls, answered and unanswered, generate AMA records. If the requirements for the network completion study are also met, then the study indicator of the call record reflects this.

**Datafill sequence and implications**

There is no requirement to datafill other tables prior to table BCCODES.

Initially table BCCODES is empty. After initial installation, deleting call types from the table is disallowed. The call codes associated with each call type can be changed as required.

**Table size**

0 to 5 tuples

**BCCODES** (continued)**Datafill**

The following table lists datafill for table BCCODES.

**Field descriptions (Sheet 1 of 10)**

Field	Subfield or refinement	Entry	Explanation and action								
CALLTYPE		AIN HIGHREV LOCAL TOLL or TOPS	Bellcore call type. Enter one of the following Bellcore call types: AIN (advanced intelligent network), HIGHREV (high revenue), LOCAL (local), TOLL (toll), or TOPS (Traffic Operator Position System).								
CODES		numeric (up to 46 call codes)	Bellcore call codes. Enter any combination of the following call codes. The call codes must be separated from each other by a blank space. If the entry in field CALLTYPE is AIN, the default is 047. Enter \$ to indicate the end of the vector.								
			<table border="1"> <thead> <tr> <th>Call code</th> <th>Explanation</th> </tr> </thead> <tbody> <tr> <td>001</td> <td>detailed message rate, timed, message billing index (MBI)</td> </tr> <tr> <td>002</td> <td>message rate, timed, MBI</td> </tr> <tr> <td>003</td> <td>detailed message rate, untimed, MBI</td> </tr> </tbody> </table>	Call code	Explanation	001	detailed message rate, timed, message billing index (MBI)	002	message rate, timed, MBI	003	detailed message rate, untimed, MBI
Call code	Explanation										
001	detailed message rate, timed, message billing index (MBI)										
002	message rate, timed, MBI										
003	detailed message rate, untimed, MBI										
<b>Note:</b> Only call codes 110 and 119 are supported for GSF031 equal access.											

**BCCODES** (continued)**Field descriptions (Sheet 2 of 10)**

<b>Field</b>	<b>Subfield or refinement</b>	<b>Entry</b>	<b>Explanation and action</b>
		004	message rate, untimed, with MBI
		005	detailed message rate, timed, no MBI
		006	station paid
		007	wide area telephone service (WATS) (station paid billing)
		008	inward WATS (INWATS), terminating entry
		009	directory assistance (411)
		010	Station paid, operator handled
		011	foreign exchange (FX), automatic flexible routing
		014	station collect
<b>Note:</b> Only call codes 110 and 119 are supported for GSF031 equal access.			

**BCCODES** (continued)**Field descriptions (Sheet 3 of 10)**

<b>Field</b>	<b>Subfield or refinement</b>	<b>Entry</b>	<b>Explanation and action</b>
		015	station special calling
		016	person paid
		017	person collect
		018	person special calling
		019	automatic collect
		021	common control switching arrangement (CCSA) sampling
		022	station special called
		023	person special called
		024	direct distance dialing (DDD), operator assisted
		026	conference trunk usage
		027	call back, person paid
<b>Note:</b> Only call codes 110 and 119 are supported for GSF031 equal access.			

**BCCODES** (continued)**Field descriptions (Sheet 4 of 10)**

<b>Field</b>	<b>Subfield or refinement</b>	<b>Entry</b>	<b>Explanation and action</b>
		028	call back, person special calling
		031	call forwarding activation
		032	tandem tie trunk
		033	directory assistance (555)
		034	signaling irregularities
		035	non-revenue
		036	subscriber line usage system (SLUS), terminating entry
		037	SLUS, overflow counts
		041	local coin
		042	time change
		043	verify, paid
		044	emergency interrupt, paid
<b>Note:</b> Only call codes 110 and 119 are supported for GSF031 equal access.			

**BCCODES** (continued)**Field descriptions (Sheet 5 of 10)**

<b>Field</b>	<b>Subfield or refinement</b>	<b>Entry</b>	<b>Explanation and action</b>
		048	usage sensitive feature call
		054	verify, special calling
		055	emergency interrupt, special calling
		057	verify, non-revenue
		058	emergency interrupt, non-revenue
		064	CMC, type 2A (originating)
		065	CMC, type 1 or 2B (terminating)
		066	CMC, type 2A (terminating)
		067	flat rate
		068	WATS (billing number)
		071	INWATS overflow count
		072	DATAPATH
<b>Note:</b> Only call codes 110 and 119 are supported for GSF031 equal access.			

**BCCODES** (continued)**Field descriptions (Sheet 6 of 10)**

<b>Field</b>	<b>Subfield or refinement</b>	<b>Entry</b>	<b>Explanation and action</b>
		074	free call
		085	electronic tandem switched call
		088	non-director y-assistance (555)
		090	sensor tracer
		092	sensor/RAO (revenue accounting office) tracer
		107	credit adjustment record
		108	carrier or operator company inward service record
		110	inter-LATA (local access and transport area) station paid
		111	inter-LATA WATS, detail
<b>Note:</b> Only call codes 110 and 119 are supported for GSF031 equal access.			

**BCCODES** (continued)**Field descriptions (Sheet 7 of 10)**

<b>Field</b>	<b>Subfield or refinement</b>	<b>Entry</b>	<b>Explanation and action</b>
		114	inter-LATA WATS, billing number
		117	inter-LATA DATAPATH
		119	terminator access record
		120	originating exchange overflow counts
		121	DATAPATH terminating record
		131	feature group A (FGA) originating
		132	FGA terminating
		134	feature group B (FGB) originating
		135	FGB terminating
		141	IC/INC number services calls
<b>Note:</b> Only call codes 110 and 119 are supported for GSF031 equal access.			



**BCCODES** (continued)

## Field descriptions (Sheet 8 of 10)

Field	Subfield or refinement	Entry	Explanation and action
		142	operating company number services calls
		189	originating call provided with credit recording service
		190	originating call provided with carrier identification processing but no service processing
		191	terminating call provided with carrier identification processing but no service processing
		192	originating call provided with call completion service
		193	terminating call provided with call completion service
<b>Note:</b> Only call codes 110 and 119 are supported for GSF031 equal access.			

**BCCODES** (continued)**Field descriptions (Sheet 9 of 10)**

<b>Field</b>	<b>Subfield or refinement</b>	<b>Entry</b>	<b>Explanation and action</b>
			194 originating call provided with a listing services service
			195 terminating call provided with a listing services service
			196 originating call provided with a general assistance service
			197 terminating call provided with a general assistance service
			198 originating call provided with a busy line verification service
			199 terminating call provided with a busy line verification service
<b>Note:</b> Only call codes 110 and 119 are supported for GSF031 equal access.			

**BCCODES** (continued)**Field descriptions (Sheet 10 of 10)**

Field	Subfield or refinement	Entry	Explanation and action
		250	carrier or customer inward service record
		251	inter-LATA 0+, 0- call transfer
		550	automatic meter reading call
		800-805	operating company use
<b>Note:</b> Only call codes 110 and 119 are supported for GSF031 equal access.			

**Datafill example**

The following example shows sample datafill for table BCCODES.

The example consists of the following settings:

- for key LOCAL, the call codes are 006, 036, 067, 074.
- for key TOLL, the call codes are 110, 134, 135.
- for key HIGHREV, the call codes are 006, 068, and 008.
- for key TOPS, the call codes are 010, 014, 108, 250, and 251.

Each option is summarized in the example below as follows:

- Option HIGHREV in table AMAOPTS is set to ON. The call is answered. If the call code is 006, 068, or 008, the call record is written. If the call code is 036, the call record is not written. Only call codes against key HIGHREV are written. All other records are suppressed.
- Option UNANS\_LOCAL in table AMAOPTS is set to ON. Options HIGHREV, UNANS\_TOLL, and UNANS\_TOPS are set to OFF. The call is unanswered. If the call code is 006, the unanswered call record is written. If the call code is 010, the unanswered call record is not written.

**BCCODES** (end)

- Option UNANS\_TOLL in table AMAOPTS is set to ON. Options HIGHREV, UNANS\_LOCAL, and UNANS\_TOPS are set to OFF. The call is unanswered. If the call code is 110, the unanswered call record is written. If the call code is 006, the unanswered call record is not written.
- Option UNANS\_TOPS in table AMAOPTS is set to ON. Options HIGHREV, UNANS\_LOCAL, and UNANS\_TOLL are set to OFF. The call is unanswered. If the call code is 010, the unanswered call record is written. If the call code is 006, the unanswered call record is not written.

**MAP display example for table BCCODES**

CALLTYPE	CODES				
LOCAL	(006)	(036)	(067)	(074)	\$
TOLL		(110)	(134)	(135)	\$
HIGHREV		(006)	(068)	(008)	\$
TOPS	(010)	(014)	(108)	(250)	(251)\$

**Table history****SN06 (DMS)**

Updated for SN06 (DMS) Standard release. Added attention boxes addressing unanswered calls. CRQ00654781.

**GSF031**

Added text stating that only call codes 110 and 119 are supported for GSF equal access.

**NA004**

Call code 048 and its associated explanation was added to field CODES.

**NA002**

Call code 550 and its associated explanation was added to field CODES.

**BCS36**

Value AIN was added to field CALLTYPE.

---

**BCCOMPAT**

---

**Table name**

Bearer Capability Compatibility Table

**Functional description**

Table BCCOMPAT defines the bearer capability (BC) pairs that are compatible. For example, a terminal with a 300-baud modem BC can communicate with a terminal with a 300- to 1200-baud modem BC.

Default BCs are not always compatible. If you set the bearer capability call screening scope to Integrated Business Network (IBN), special consideration is made for the data unit BC.

Data units can terminate on any station. You cannot remove this capability if modems are used on voice lines. Two selections are available:

- Non-ISDN terminals can have associated synonym directory numbers (DN). This condition is not recommended if ISDN terminals and data units use synonym numbers. This condition impacts the dial plan. In an environment that uses a large number of synonym DNs, the users must know a larger set of numbers to access different services.
- The best selection is to manipulate the BC compatibilities so that none of the current capabilities of data units are lost. Make the data unit BC compatible with the other BCs the data unit can communicate with. This procedure assists users to call data units and data units to call users.

See table BCDEF for additional information and a list of the default BCs.

**Datafill sequence and meaning**

You must enter data in table BCDEF before you enter data in table BCCOMPAT.

Table BCDEF defines all BCs used in table BCCOMPAT.

Office parameter DEFAULT\_BEARER\_CAPABILITY in table OFCENG controls the BC default for the office. The two options are SPEECH and 3\_1KHZ. See table OFCENG for more information on this parameter.

**Table size**

2 to 63 tuples

**BCCOMPAT** (continued)

A maximum of 3906 ( $63 \times 63 - 63$ ) BC pairs are defined. View table BCCOMPAT as a  $63 \times 63$  matrix of Booleans defining the compatible BC pairs as appears in table Table , "Table matrix for BC pairs" on page -66.

**Table matrix for BC pairs**

		TERMBC									
CALLBC	1	2	..	17	..	..	26	..	63		
1	Y	N	N	N	N	N	N	N	N	N	N
2	N	Y	N	N	N	N	N	N	N	N	N
:	N	N	Y	N	N	N	N	N	N	N	N
17	N	N	N	Y	N	N	1	N	N	N	N
20	N	N	N	3	Y	N	N	N	N	N	N
:	N	N	N	N	N	Y	N	N	N	N	N
26	N	N	N	2	N	N	Y	N	N	N	N
:	N	N	N	N	N	N	N	Y	N	N	N
63	N	N	N	N	N	N	N	N	N	N	Y
<p><b>Note:</b> TERMBC = terminating bearer capability name            CALLBC = incoming call bearer capability name            Y = BCs are compatible and cannot be changed            N = BCs are not compatible and can be datafilled            1 = CALLBC 17 and TERMBC 26            2 = CALLBC 26 and TERMBC 17            3 = CALLBC 20 and TERMBC 17</p>											

**Note:** BCs are always compatible with other BCs.

Terminals with identical BCs can communicate with each other. Table BCCOMPAT does not display tuples that contain identical BCs. Set the diagonal for the table to Y (yes) at initial program load (IPL) time. The user cannot modify the setting.

Reserve the value 0 (zero) for the NIL\_BC BC. Value 0 is not used in table BCCOMPAT.

**BCCOMPAT** (continued)**Datafill**

The datafill for table BCCOMPAT appears in the following table.

**Field descriptions (Sheet 1 of 3)**

Field	Subfield or refinement	Entry	Explanation and action
KEY		see subfields	<i>Key.</i> This field contains subfields CALLBC and TERMBC. Separate the two subfields with a space.
	CALLBC	3_1KHZ 7_1KHZ 56KDATA 64KDATA 64KX25 64_RATE_ AD_DATA DATAUNIT SPEECH VOICE_ DATA	<p><i>Incoming call bearer capability name.</i> Enter the BC name (BCNAME) of the incoming call. Enter the BCNAME data in table BCDEF. The BCNAME specifies a user-defined name that describes the BC and can describe the low layer capability.</p> <p>Enter 3_1KHZ for the default BC for calls originated from trunks other than primary rate access (PRA), ISDN user part (ISUP), intermachine trunk (IMT), and dedicated access line (DAL). Use this BC primarily for the transport of speech and voiceband data.</p> <p>Enter 7_1HKZ for voice band high quality audio and voice band data. Use this BC for high quality audio applications like music. You can use this BC for voiceband data.</p> <p>Enter 56KDATA for the basic 56-kbit/s data adapted for 64-kbit/s data. This BC is the North American typical data rate. This BC uses only 7 bits of data sampled at 8000 times per second for the 56-kbit/s rate. The eighth bit of every octet is 1. This condition occurs so that an all 0 (zero) octet does not occur and cause the problems that can occur with 64KDATA.</p>

**BCCOMPAT** (continued)

## Field descriptions (Sheet 2 of 3)

Field	Subfield or refinement	Entry	Explanation and action
	CALLBC (continued)		<p>Enter 64KDATA for ISDN circuit switched packet data calls. This BC is 64 kbit/s of clear channel data. This BC uses all of the 64 kbit bandwidth for data. The 16 following 0s (zero) can occur. Most operating companies in North America use 56 kbit/s data transport because of the problems that can occur with North American repeaters. This action occurs if 16 following 0s (zeros) are received. Use techniques like B8ZS on the data to alleviate the problem.</p> <p>Enter 64KX25 for packet data calls in the X.25 packet network. The encoded data is according to X.25 protocol.</p> <p>Enter 64_RATE_AD_DATA if the data stream contains less than 64 kbit/s and the stream is bit-stuffed to a 64 kbit data rate. Use this BC for applications where the data rate is less than 64 kbit/s (2400, 4800, 9600, 16 000, 19 600, 32 000, 48 000). Use this BC when the remaining bandwidth on the channel is stuffed according to the correct CCITT protocols regarding rate adaption.</p> <p>Enter DATAUNIT for the normal 56KDATA adapted for 64KDATA on primarily non-ISDN data units. This BC is equivalent to the 56KDATA BC.</p>



**BCCOMPAT** (continued)

## Field descriptions (Sheet 3 of 3)

Field	Subfield or refinement	Entry	Explanation and action
	CALLBC (continued)		<p>Enter SPEECH for the default BC for calls that originate from 500/2500 sets and electronic business sets (Northern Telecom multikey business set). Enter SPEECH for the default BC for calls that originate from attendant consoles (Northern Telecom Integrated Business Network (IBN) attendant console). This BC is also assigned to calls over trunks. This BC is for the transport of speech. Use this BC to transport voiceband data, if voice compression techniques are not used on the data.</p> <p>Enter VOICE_DATA for backward compatibility with the DMS-250 feature AD0499 (DAL &amp; IMT Switched 56 KB Data &amp; Multiple PINs per Auth CP). This BC is available in feature packages NTX222AB (DMS-250 Call Processing Type II) and NTX222BA (DMS-250 Call Processing (Type II)). Use this BC on the DMS-250 switch only.</p>
	TERMBC	3_1KHZ 7_1KHZ 56KDATA 64KDATA 64KX25 64_RATE_ AD_DATA DATAUNIT SPEECH VOICE_ DATA	<p><i>Terminating bearer capability name.</i> Enter the BCNAME of the terminator. See field CALLBC for the definition of each BC.</p>

**Datafill example**

Sample datafill for table BCCOMPAT appears in the following example.

The entry of the following two tuples occurs by default during the loadbuild process.

## **BCCOMPAT** (end)

---

### **MAP example for table BCCOMPAT**

KEY	
SPEECH	3_1KHZ
3_1KHZ	SPEECH

### **Table history**

#### **BCS36**

Verified correct BCs in fields CALLBC and TERMBC in BCS36.

---

**BCDEF**

---

**Table name**

Bearer Capability Definition Table

**Functional description**

Table BCDEF defines the required bearer capabilities (BC). The BCDEF can define a maximum of 59 BCs. The system enters ten default BCs when you enter data in the switch. See the table “Default bearer capabilities” in the Additional information for the default BCs.

Most ISDN calls use a small number of BCs.

**Datafill sequence and meaning**

You must enter data in table DTUPRO before you enter data in table BCDEF.

Office parameter DEFAULT\_BEARER\_CAPABILITY in table OFCENG controls the BC default for the office. The default can be SPEECH or 3\_1KHZ. See table OFCENG for additional information on this parameter.

**Table size**

0 to 64 tuples

The table is a fixed size.

**BCDEF** (continued)**Datafill**

Datafill for table BCDEF appears in the following table.

**Field descriptions (Sheet 1 of 5)**

Field	Subfield or refinement	Entry	Description
KEY		see subfield	<i>Key.</i> This field contains subfield BCNAME.
	BCNAME	3_1KHZ 7_1KHZ 56KDATA 64KDATA 64KX25 64_RATE_ AD_DATA DATAUNIT NILBC SPEECH VOICE_ DATA	<i>Bearer capability name.</i> This subfield is the key to the table. This subfield specifies a name you define that describes the bearer capability (BC) and can describe the low layer capability.  Enter 3_1KHZ for the default BC for calls that originate from trunks other than primary rate access (PRA) and ISDN user part (ISUP). Enter 3_1KHZ for the default BC for calls that originate from trunks other than intermachine trunk (IMT) and dedicated access line (DAL). Use this BC to transport of speech and voiceband data.

**BCDEF** (continued)

**Field descriptions (Sheet 2 of 5)**

<b>Field</b>	<b>Subfield or refinement</b>	<b>Entry</b>	<b>Description</b>
			<p>Enter 7_1HKZ for voice band high quality audio and voice band data. Use this BC for high quality audio applications like music. You can use this BC for voiceband data.</p> <p>Enter 56KDATA for the basic 56-kbit/s data adapted for 64 kbit/s data. This data rate is the normal North American data rate. This BC uses 7 bits of data sampled at 8000 times for each second for the 56 kbit/s rate. The eighth bit of every octet is 1. This condition makes sure that an all 0 (zero) octet does not occur. An all 0 (zero) octet can and cause problems with 64KDATA.</p> <p>Enter 64KDATA for ISDN circuit switched packet data calls. This BC is 64 kbit/s of clear channel data. This BC uses the 64 kbit bandwidth for data. The number of consecutive 0s (zero) can be 16. Most operating companies in North America use 56 kbit/s data transport. This condition occurs because of the problems that can occur with North American repeaters if the system receives 16 consecutive 0s (zeroes). Use techniques like B8ZS on the data to make sure the problem is not present.</p>

**BCDEF** (continued)**Field descriptions (Sheet 3 of 5)**

Field	Subfield or refinement	Entry	Description
	BCNAME (continued)		<p>Enter 64KX25 for packet data calls in the X.25 packet network. The system follows the X.25 protocol to encode data.</p> <p>Enter 64_RATE_AD_DATA if the data stream contains less than 64 kbit/s and the stream is bit-stuffed to a 64 kbit/s data rate. Use this BC for applications where the following conditions apply:</p> <ul style="list-style-type: none"> <li>• data rate is less than 64 kbit/s (2400, 4800, 9600, 16 000, 19 600, 32 000, 48 000)</li> <li>• the bandwidth that remains on the channel is stuffed according to the correct CCITT protocols for rate-adaption.</li> </ul> <p>Enter DATAUNIT for the basic 56KDATA adapted for 64KDATA on primarily non-ISDN data units. This BC is equivalent to the 56KDATA BC.</p> <p>Enter NILBC if bearer capability is not required for the call, for example, plain ordinary telephone service (POTS) calls.</p> <p>Enter SPEECH for the default BC for calls that originate from 500/2500 sets, electronic business sets or attendant consoles. Electronic business sets can be a Northern Telecom multikey business set. The attendant consoles can be a Northern Telecom Integrated Business Network [IBN] attendant console. This BC is assigned to calls over trunks. Use this BC for the transport of speech. Use this BC to transport voiceband data, if voice compression techniques do not occur on the data.</p>

**BCDEF** (continued)

## Field descriptions (Sheet 4 of 5)

Field	Subfield or refinement	Entry	Description
BCDATA	BCNAME (continued)		Enter VOICE_DATA for backward compatibility with the DMS-250 feature AD0499 (DAL & IMT Switched 56 KB Data & Multiple PINs per Auth CP). The feature is available in feature packages NTX222AB [DMS-250 Call Processing Type II] and NTX222BA (DMS-250 Call Processing [Type II]). Use this BC on the DMS-250 switch.
		see subfields	<i>Bearer capability data.</i> This field contains subfields XFERCAP, XFERMOD, and CODINGST.
	XFERCAP	SPEECH UNRESDIG RESDIG AU3_1KHZ or AU7KHZ	<p><i>Transfer capability.</i> Enter the transfer capability that describes the data that the system transmits.</p> <p>Enter AU3_1KHZ if the system transmits audio data at 3.1 kHz.</p> <p>Enter AU7KHZ if the system transmits audio data at 7 kHz.</p> <p>Enter RESDIG if restricted digital information is required for packet mode calls and most circuit mode data calls. Enter RESDIG if the network with every transparent data transfer capability provides information transfer capability.</p> <p>Enter SPEECH for standard voice calls.</p>
	XFERCAP (continued)		<p>Enter UNRESDIG if packet mode calls and most circuit mode data calls require digital information that is not required. Enter UNRESDIG if restricted digital information refers to the information transfer capability a network capable of 56 kbit/s transparent data transfer.</p> <p>If the entry in field BCNAME is 56KDATA or DATAUNIT, the default value is UNRESDIG.</p>

**BCDEF** (continued)**Field descriptions (Sheet 5 of 5)**

<b>Field</b>	<b>Subfield or refinement</b>	<b>Entry</b>	<b>Description</b>
PROTOTYP	XFERMOD	CIRCUIT or PACKET	<p><i>Transfer mode.</i> Enter the transfer mode that describes the mode of transmission.</p> <p>Enter CIRCUIT if the call is a circuit switched call.</p> <p>Enter PACKET if the call is a packet data call.</p> <p>If the entry in field BCNAME is 56KDATA or DATAUNIT, the default value is CIRCUIT.</p>
	CODINGST	CCITT or NETWORK	<p><i>Coding standard.</i> Enter the coding standard for bearer capability and low layer capability.</p> <p>Enter CCITT if the use of CCITT coding standard occurs. Additional datafill is not required.</p> <p>Enter NETWORK if a network specified coding standard is required and datafill refinement PROTOTYP.</p> <p>If the entry in field BCNAME is 56KDATA or DATAUNIT, the default value is NETWORK.</p>
		DTU MODEM or OTHER	<p><i>Protocol type.</i> Enter the protocol type of the device at the endpoint of the connection.</p> <p>Enter DTU (data terminating unit) and datafill refinements DTUPRO, DTUSYNC, and DTURATE on the next page</p> <p>Enter MODEM (modem) and enter data in refinement MODEMPRO, MODEMSNC, and MODEMRTE in the section "PROTOTYP = MODEM".</p> <p>Enter OTHER (other device) and enter data in refinement DISCRIM in the section "PROTOTYP = OTHER"..</p> <p>If the entry in field BCNAME is 56KDATA or DATAUNIT, the default value is DTU.</p>



**BCDEF** (continued)**PROTOTYP = DTU**

If the entry in refinement PROTOTYP is DTU, enter data in refinements DTUPRO, DTUSYNC, and DTURATE. See the following description.

**Field descriptions for conditional datafill**

Field	Subfield or refinement	Entry	Description
	DTUPRO	NONE TLINK or X25	<p><i>Data terminating unit protocol.</i> Enter the DTU protocol used. Define the name that identifies the protocol in table DTUPRO.</p> <p>If the entry in field BCNAME is 56KDATA, the default value is NONE.</p> <p>If the entry in field BCNAME is DATAUNIT, the default value is TLINK.</p>
	DTUSYNC	Y or N	<p><i>Data terminating unit communication.</i> Enter Y (yes) if communication is synchronous. Enter N (no) if communication is asynchronous.</p> <p>If the entry in field BCNAME is 56KDATA or DATAUNIT, the default value is Y.</p>
	DTURATE	75BS, 150BS, 300BS, 600BS, 1200BS, 2400BS, 3600BS, 4800BS, 7200BS, 16KBS, 9600BS, 14400BS, 16KBS, 19200BS, 32KBS, 48KBS, 8KBS, or AUTO	<p><i>Data terminating unit data rate.</i> Enter the data access rate of the modem.</p> <p>If the entry in field BCNAME is 56KDATA or DATAUNIT, the default value is 56KBS.</p>

**BCDEF** (continued)**PROTOTYP = MODEM**

If the entry in refinement PROTOTYP is MODEM, enter data in refinements MODEMPRO, MODEMSNC, and MODEMRTE. See the following description.

**Field descriptions for conditional datafill**

Field	Subfield or refinement	Entry	Description
	MODEMPRO	alphanumeric (a maximum of 32 characters)	<i>Modem protocol.</i> Enter the modem protocol used. Define the name that identifies the protocol in table MODEMPRO.
	MODEMSNC	Y or N	<i>Modem communication.</i> Enter Y (yes) if communication is synchronous. Enter N (no) if communication is asynchronous.
	MODEMRTC	75BS, 150BS, 300BS, 600BS, 1200BS, 2400BS, 3600BS, 4800BS, 7200BS, 16KBS, 9600BS, 14400BS, 16KBS, 19200BS, 32KBS, 48KBS, 56KBS, 8KBS, or AUTO	<i>Modem data rate.</i> Enter the modem data access rate.

**BCDEF** (continued)**PROTOTYP = OTHER**

If the entry in refinement PROTOTYP is OTHER, enter data in refinement DISCRIM. See the following description.

**Field descriptions for conditional datafill**

Field	Subfield or refinement	Entry	Description
DISCRIM		0 to 63	<i>Discriminator.</i> Enter a positive integer value. Use the value entered as a discriminator between the different OTHERs.

**Datafill example**

Sample datafill for table BCDEF appears in the following example.

See the following table “Default bearer capabilities” for a list of the default tuples. The addition of a tuple during load build appears in the following example.

**MAP example for table BCDEF**

KEY	BCDATA
SPEECH	SPEECH CIRCUIT CCITT

**Table history****BCS36**

The following changes occurred in table BCDEF in BCS36:

- default values in field BCNAME
- default values for protocol type DTU
- explanation of default bearer capabilities
- explanation of synonym DNs

**Additional information**

This section provides information on how to enter default bearer capabilities in table BCDEF. This section also provides product descriptive information related to table BCDEF.

**BCDEF** (continued)**Default bearer capabilities**

Table “Default bearer capabilities” contains the order of the ten default BCs the system enters in table BCDEF. The order of the default BCs is order-dependent. The operating company cannot change the datafill. This condition applies because constants are set up in the software code for each of default BC.

The system enters the ten default BCs when the switch is booted.

The operating company can enter additional BCs in any order.

**Default bearer capabilities**

BCNAME	XFERCAP	XFER-MODE	CODINGST	PROTO TYPE	DTU-PRO	DTU-SYNC	DTU-RATE
SPEECH	SPEECH	CIRCUIT	CCITT				
64KDATA	UNRESDIG	CIRCUIT	CCITT				
64KX25	RESDIG	CIRCUIT	NETWORK	DTU	X25	Y	AUTO
56 KDATA	UNRESDIG	CIRCUIT	NETWORK	DTU	NONE	Y	56KBS
DATAUNIT	UNRESDIG	CIRCUIT	NETWORK	DTU	TLINK	Y	56KBS
64KRES	RESDIG	CIRCUIT	CCITT				
3_1KHZ	AU3_1KHZ	CIRCUIT	CCITT				
7_KHZ	AU7KHZ	CIRCUIT	CCITT				
VOICE_ DATA	AU3_1KHZ	CIRCUIT	CCITT				
64K_RATE _AD_DATA	UNRESDIG	CIRCUIT	CCITT				

**Synonym directory numbers**

The ISDN terminals can have more than one call appearance with the same DN and with different BCs. Intra-ISDN calls terminate on call appearances. The BC of the incoming call and on the BC of the terminator determines if calls terminate on call appearances. The originator of a call to an ISDN terminal can require that the originating BC be different from the default BC. For example, data calls that go over trunks, or MODEM use on voice lines.

---

**BCDEF** (end)

---

Use one of the following two methods to specify different BCs:

1. In an IBN environment, dial a feature access code and the DN of the desired party. This method is not compatible with current POTS dial plans.
2. Enter a set of synonym DNs for terminals to receive calls from non-ISDN terminals or other ISDN networks. When one of these synonym DNs is called, the BC associated with the synonym DN replaces the original call. The call terminates on the desired call appearance (CAP) on the ISDN terminal. Each ISDN terminal with more than one CAP with the same DN but with different BCs can use synonym numbers associated with a BC. Each synonym DN is different. To terminate on a CAP with the desired BC, the synonym DN associated with that BC is dialed.
  - a. Define synonym DNs with the following function: (synonym DN) = actual DN + BC

## **BCLIDGRP**

---

### **Table name**

Bulk Calling Line Identification Group Table

### **Functional description**

Table BCLIDGRP is one of the tables involved in implementing the Custom Local Area Signaling Services (CLASS) Bulk Calling Line Identification (BCLID) feature.

Feature BCLID allows Centrex lines, plain ordinary telephone service (POTS) lines, Residential Enhanced Services (RES) lines, uniform call distribution (UCD) groups, hunt groups, or private branch exchange (PBX) customers with a direct inward dial (DID) plan to receive call-related information on incoming calls to the respective lines, groups, or customers.

The call-related data is transmitted to the customer premises equipment (CPE) by means of one or more dedicated Bell 202A-compatible data channels. The CPE collects the transmitted information for immediate use or storage. Since the data is transmitted over a data channel, the transmission does not affect the ability of the CPE to receive incoming calls or place outgoing calls.

Table BCLIDGRP lists BCLID group numbers with their respective assigned features. The BCLID data channel links are also defined for each BCLID group number.

A maximum of 4096 BCLID data channel links can be defined in an office.

A CLASS modem resource (CMR) card must be present and datafilled correctly for the transmission of the BCLID message to the CPE.

Feature BCLID is only supported on Bell 202A-compatible modems. Bell 212A modems are not supported.

The BCLID data channel links are only supported on the following peripheral module (PM) types: LGC, LTC, RCC, SMS, and SMU equipped with a CMR card.

The BCLID data channel links are only supported on the following card codes: NT6X17, NT6X18, NT3A06, and SCD203.

The BCLID and simplified message desk interface (SMDI) features cannot share a common data channel link.

**BCLIDGRP** (continued)**Datafill sequence and implications**

Table IBNLINES must be datafilled before table BCLIDGRP.

Assign BCLID groups in sequential numeric order to minimize data store usage for this feature.

A line equipment number (LEN), which defines the data channel link for the BCLID feature group, must be defined in table IBNLINES before it is used in table BCLIDGRP.

In table OFCOPT, office parameter MAX\_BCLID\_DATA\_LINKS defines the maximum number of BCLID data channel links that can be defined in the central office switch.

**Table size**

0 to 2048 tuples

Data store is dynamically allocated for each tuple in table BCLIDGRP.

**Datafill**

The following table lists datafill for table BCLIDGRP.

**Field descriptions (Sheet 1 of 3)**

Field	Subfield or refinement	Entry	Explanation and action
BCGRPNUM		0 to 2047	<i>Bulk calling group number</i> Enter Bulk Calling Line Identification (BCLID) group number. This is the index into the table. Assign the group numbers in numerical order so that data store usage is minimized.
USP		Y or N	<i>Usage sensitive pricing</i> Enter Y (yes) for usage-sensitive pricing. Otherwise, enter N (no).
BILLDN		numeric (up to 11 digits)	<i>Billing directory number</i> Enter the billing directory number (DN). This field indicates a billing DN that appears in the automatic message accounting (AMA) billing records (if generated).
<b>Note:</b> Canada only			

**BCLIDGRP** (continued)

## Field descriptions (Sheet 2 of 3)

Field	Subfield or refinement	Entry	Explanation and action
DNDISP		FIRST, LAST or BOTH	<i>Directory number display</i> Enter which number is displayed first or last. For call forwarding, the first or last DN is displayed in the BCLID message.
DATE		Y or N	<i>Message date</i> Enter Y to record the date in the BCLID message. Otherwise, enter N.
TIME		Y or N	<i>Message time</i> Enter Y to record the time in the BCLID message. Otherwise, enter N.
INTRAGRP		Y or N	<i>Intragroup call message generation</i> Enter Y for the recording of calls made from the same BCLID group as the receiver. Enter N to suppress BCLID messages generated by calls from the same BCLID group.
CFIND		Y or N	<i>Call forward indication</i> Enter Y to display the call forward indication (CFI) field in the BCLID message record. Otherwise, enter N.
BSYSEND		Y or N	<i>Busy message sending</i> Enter Y to send a busy message if a caller reaches a busy line in the BCLID group. Otherwise, enter N.
DSP800DN (see note)		Y or N	<i>Display 800 dialed directory number</i> Enter Y to indicate that all messages generated for this group are to incorporate the dialed 800 number, if available, into the contents of the BCLID message.  The default value for this field is N and can be changed to Y if the following conditions are met: <ul style="list-style-type: none"> <li>• the switch is capable of receiving ISDN user part (ISUP) messages</li> <li>• field DATE is set to N</li> <li>• field TIME is set to N</li> </ul>

**Note:** Canada only



**BCLIDGRP** (end)

## Field descriptions (Sheet 3 of 3)

Field	Subfield or refinement	Entry	Explanation and action
BCLNKLEN		see template (see table IBNLINES)	<i>Bulk calling data link line equipment number</i> This field consists of subfields SITE, FRAME, of the LEN template. Enter the line equipment number (LEN) of the CMR card assigned as the data channel link for the BCLID feature for this group. A minimum of one link must be provided. A maximum of 16 links can be provided. The LEN must exist in table IBNLINES before it can be used in the field BCLNKLEN.
CONTMARK		+ or \$	<i>Continuation mark</i> Enter + if additional information for this tuple is contained in the next record. Otherwise, enter \$ to indicate the end of the tuple.
<b>Note:</b> Canada only			

**Datafill example**

The following example shows sample datafill for table BCLIDGRP.

**MAP display example for table BCLIDGRP**

```

BCGRPNUM USP      BILLDN DNDISP DATE TIME INTRAGRP CFIND
BSYSEND DSP800DN
                                     BCLNKLEN
-----
      0   N 15195551212  FIRST   Y   Y       N   N       Y
N
                (HOST 00 0 00 00) (REM1 01 0 01 10)$

```

## BCLIDLNK

---

### Table name

Bulk Calling Line Identification Link Table

### Functional description

Table BCLIDLNK is one of the tables involved in implementing the custom local area signaling services bulk calling line identification (CLASS:BCLID) feature.

For related information, refer to table BCLIDGRP.

Table BCLIDLNK lists BCLID group numbers with their respective assigned BCLID links.

*Note:* This table is read only. It cannot be added to, or deleted from, directly. The content of the table BCLIDLNK depends entirely on the content of table BCLIDGRP.

In each BCLID group, a minimum of one and a maximum of 16 data links can be defined up to a total maximum of 4096 data links per office.

### Datafill sequence and implications

The following tables must be datafilled before table BCLIDLNK.

- IBNLINES
- BCLIDGRP

There is no requirement to datafill other tables prior to table BCLIDLNK.

### Table size

0 to 2048 tuples

**BCLIDLNK** (continued)**Datafill**

The following table lists datafill for table BCLIDLNK.

**Field descriptions**

Field	Subfield or refinement	Entry	Explanation and action
BCGRPNUM		0 to 2047	<i>Bulk calling group number</i> This is the index into the table. Assign the group numbers in numeric order so that data store usage is minimized.
AVAIL		numeric (0 to 32767)	<i>Number of calling DN available messages</i> This field, updated by the DMS, keeps track of the number of calling directory number (DN) available messages sent to this BCLID group.  The default value is 0 (zero).
UNAVAIL		numeric (0 to 32767)	<i>Number of private and out-of-area messages</i> This field, updated by the DMS, keeps track of the number of private and out-of-area messages sent to this BCLID group.  The default value is 0.
BCLINKS		see subfields	<i>Bulk calling data link line equipment numbers</i> The field BCLINKS consists of subfield LEN and BCLIDCPB.  Enter the line equipment number (LEN) of the CLASS modem resource (CMR) card assigned as the data channel link for BCLID feature for this group. A minimum of one link must be provided. A maximum of 16 links can be provided. The LEN must exist in table IBNLINES before it can be used in field BCLNKLEN.  Refer to table IBNLINES for the description of the field LEN and the respective datafill for the field.
	BCLIDCPB	Y or N	<i>BCLID call processing busy</i> This field is set to Y (yes) if call processing traffic is detected on the BCLID data link by the DMS. Otherwise, the field is set to N (no).

---

**BCLIDLNK** (end)

---

**Datafill example**

An example of datafill for table BCLIDLNK is shown below. Note that 2 of a maximum of 16 data link LENS have been assigned to this bulk calling line identification group number (BCGRPNUM).

**MAP display example for table BCLIDLNK**

BCGRPNUM	AVAIL	UNAVAIL	BCLINKS
8	1	0	(HOST 00 0 08 15 Y) \$
10	0	0	(HOST 00 0 10 5 N) \$

---

## BEARNETS

---

**ATTENTION**

This table applies to new or modified content for SN07 (DMS) that is valid through the current release.

### Bearer Networks supported

Table Bearer Networks (BEARNETS) identifies the bearer networks supported by the server and the network options that apply to the packet networks on a succession call server.

The overall default packet network for the office is determined by the assignment of the `packet_network_default` option to a single tuple in the table. If no packet network is detected in the provisioning hierarchy for a packet agent, this default packet network will be used.

### Datafill sequence and meaning

The tables must be datafilled in the following sequence:

- ENINV
- CLLI
- BEARNETS
- NETBRDGE
- NETPATH
- NET2NET
- MNNODE
- SERVINV
- TRKOPTS

### Table size

8 tuples maximum (memory is not allocated unless tuples are provisioned, that is, `NETWORK_ACTIVE = EXTENET`)

## Datavill

The following table lists the datavill for table BEARNETS.

### Field, subfield, and refinement descriptions for table BEARNETS (Sheet 1 of 2)

Field	Subfield or refinement	Entry	Explanation and action
NETIDX		0 to 7	<p>This field defines the key to the table, and entries are displayed as "NET 0" to "NET 7".</p> <p>Adding a tuple in table BEARNETS automatically creates a tuple in table NET2NET with \$.</p> <p>You can not delete a BEARNETS tuple unless the NET2NET entry contains a \$, and that tuple is the only reference.</p>
BNETNAME		vector of up to 32 characters	<p>This field identifies the name of the bearer network. This name is used in other tables to reference the associated bearer network and its characteristics. Making the name a field of the tuple rather than the index allows you to make name changes to the networks defined.</p> <p>The 32 character name of the network must be unique across the table.</p>
DISPLAY		vector of up to 4 characters	<p>This field identifies the a 4 character string that will be used to display the bearer network on the MAP screens. You must define a unique string across the bearer networks, which is implemented in table control.</p>
FABRIC		ENET, AAL1, AAL2, or IP	<p>The field defines the bearer network fabric type. Only one ENET tuple is allowed, an ENET tuple can be added only if ENET exists in the network.</p>

**Field, subfield, and refinement descriptions for table BEARNETS (Sheet 2 of 2)**

Field	Subfield or refinement	Entry	Explanation and action
OPTIONS		vector of {pkt_network_default}	This field defines the vector of the options against the bearer network.
	pkt_network_default		<p>This subfield indicates that this tuple is the packet bearer network default for the office. It is primarily used in initializing dependant tables during an ONP. The first packet network added is the default packet.</p> <p>Only one tuple may have this option assigned. If the option is added to another tuple, the option is removed from the first tuple.</p> <p>You can remove this option from a tuple only by assigning it to another tuple. Also, you can delete the network default tuple only if it is the last remaining packet network tuple.</p> <p><b>Note:</b> This option can not be assigned if FABRIC = ENET.</p>

**Datafill example**

The following example shows sample datafill for table BEARNETS.

**MAP display example for table BEARNETS**

NETIDX	NETNAME	DISPLAY	FABRIC	OPTIONS
NET 0	TDM_ENET	ENET	ENET	\$
NET 1	NET_AAL1	ATM	AAL1	(PKT_NETWORK_DEFAULT) \$
NET 2	NET_IP	IP	IP	\$
NET 3	NET_AAL2	AAL2	AAL2	\$

**Supplementary information**

Table BEARNETS, along with tables NETBRDGE, NETPATH, and NET2NET, is required to be provisioned in all Succession sites supporting bridged calls from a TDM network to a packet network.

When using the FINDREF tool on table BEARNETS, you must encapsulate the key field within single parentheses. For example:

```
FINDREF BEARNETS 'NET 1'
```

On an ONP, this table is provisioned automatically both TDM and packet networks tuples where they exist.

- If the from side datafill contained an ENET, the NET 0 tuple from the datafill example will be provisioned automatically
- If the from side supported packet nodes (as indicated by the setting of the PRE\_SN07\_DUMPSIDE\_NETWORK\_FABRIC), the NET 1 tuple will be provisioned and marked as the PKT\_NETWORK\_DEFAULT

## **Table history**

### **SN07 (DMS)**

New table BEARNETS is created as part of activity Q01083765.



---

**BELLCAT**

---

**Table name**

Bell CAtegory (formerly called ANIID Mapping for TOPS Trunk Groups with Bell Signaling Table)

**Functional description**

Table BELLCAT allows the operating company to define the following upon receipt of a specified automatic number identification (ANI) identification (ID) digit over a Traffic Operator Position System (TOPS) trunk with Bell signaling:

- The expected number of digits to be found in the ANI spill as determined by the entry in field FORMAT. which is used to set the ANI status of the call by comparing the digits received to the expected format. If the format is found to be invalid, other data in table BELLCAT cannot be accessed.
- The method of determining the call origination type and the calling service feature is defined by the entry in field CLGSERV. Field CLGSERV can set the call origination type or calling service feature if the call comes over a trunk group that may carry more than one type of traffic. If the trunk is a dedicated type, this field is ignored.
- An optional route (field ANIROUTE). An optional route that overrides any route specified in the pretranslator can also be specified. This can route the call to a TOPS (or, up to BCS35, to the Auxiliary Operator Assistance System [AOSS]) position under a new call origination type or out of the office on a different trunk group.

Bell signaling protocol consists of the following three formats:

- *DP (dial pulse) called number format* key pulse (KP) digit 7 or 10 calling line delivery (CLD) digits
- *MF (multifrequency) called number format* KP digit 0, 7 or 10 CLD digits CLD signaling terminal (ST)\* digit
- *MF ANI spill format* KP digit ID digit 7 CLG digits CLG ST\* digit

Table BELLCAT uses the MF ANI spill format if the KP signal is a string delimiter, the ST signal indicates whether the call is coin or non-coin, and whether the call requires operator intervention. The ID digit is used to carry further information about the ANI status and type of calling subscriber.

An ANI ID digit must be received in order to access any information in table BELLCAT, or the call is marked as ANI FAIL and routed to a TOPS position.

If the ANI format is violated (even though an ANI ID digit is received, the ANI spill is not one of the valid formats specified in table BELLCAT), the following

**BELLCAT** (continued)

information can be used to set the calling service feature and the call origination type:

- Information inherent in the trunk group (dedicated trunks)
- ST signal can be used to set the call origination type if the trunk group is MF (since CLD ST pulse is used in this case)
- If the ANI spill is simply missing the CLG ST pulse, but the call has a valid format, table BELLCAT can be used to set the calling service feature and a route.

The following table shows the default values for the fields.

**Default values for fields in table BELLCAT**

Field ID	Field Format	Field CLGSERV	Field ANIROUTE
0	ANI	STATION	N
1	ONI	STATION	N
2	ANIF	STATION	N
3	ANI	STATION	N
4	ONI	STATION	N
5	ANIF	STATION	N
6	ANI_ANIF	HOTEL	N
7	ANI	SPECIAL	N
8	ANIID	ALM	N
9	ANI_ANIID	INTC	N

Since BELLCAT is a static table with default values, the operating company can only change these values by using the table editor command REP (replace).

**Datafill sequence and implications**

The following tables must be datafilled after table BELLCAT.

- OFRT
- TOPS
- TOPSTOPT

**BELLCAT** (continued)**Table size**

Memory allocation is static and fixed to 10 entries.

**Datafill**

The following table lists datafill for table BELLCAT.

**Field descriptions (Sheet 1 of 5)**

Field	Subfield or refinement	Entry	Explanation and action
ID		see subfield	Identification. This field consists of subfield ANI_DIG.
	ANI_DIG	0 to 9	Automatic number identification digit. Enter the identification (ID) digit found in the multifrequency (MF) automatic number identification (ANI) spill outputted from the originating office to the end office.
FORMAT		see below	ANI format. Enter the code to identify the number of digits expected in a valid format ANI spill.
		ANI	Enter ANI if an ANI ID digit, a 7-digit calling number, and a signaling terminal (ST) signal are expected. The call is marked as ANI SUCCESS.
		ANI_ANIF	Enter ANI_ANIF if at least an ANI ID digit and an ST signal are expected. If no calling (CLG) digits are received, an ANI failure is identified by the originating office. If seven digits are received, the call is marked as ANI SUCCESS.
		ANI_ANIID	Enter ANI_ANIID if at least an ANI ID digit and an ST signal are expected. If no CLG digits are received, operator identification of the CLG number is not required. If seven digits are received, the call is marked as ANI SUCCESS.
		ANIF	Enter ANIF if an ANI failure has been detected at the originating office and an ANI ID digit and an ST signal are expected. Operator identification of the CLG number is required.

**BELLCAT** (continued)

## Field descriptions (Sheet 2 of 5)

Field	Subfield or refinement	Entry	Explanation and action
CLGSERV		ANIID	Enter ANIID if an ANI ID digit and an ST signal are expected, no CLG number is expected, and operator identification of the CLG number is not required.
		ONI	Enter ONI (operator number identification) if an ANI ID digit and an ST signal are expected and operator identification of the CLG number is required. The ANI status is set to ONI_CALL.
		see below	Calling service feature and call origination type. If the Traffic Operator Position System (TOPS) trunk group is dedicated (field STATCLAS set to ALARM, COIN, HOTEL, INTCPT, MOBILE, NONCOIN, or TOLLSTA in table TRKGRP), then the calling service feature is set from the trunk group data unless ALM, INTC, or MOBILE is entered in field CLGSEV.  The call origination type is set if the TOPS trunk group is dedicated to mobile, attended pay station, alarm intercept, toll subscriber, toll station.  Otherwise enter one of the calling service features and call origination types listed below.
		ALM	Enter ALARM if the calling service feature is to be set to STATION, regardless of the originating trunk group, and the call origination is to be set to ALM.
		BLDNINTC	Enter BLDNINTC if the calling service feature is set to STATION and the call origination is set to intercept. For BLDNINTC, the intercept call type is set to blank number intercept.

**BELLCAT** (continued)**Field descriptions (Sheet 3 of 5)**

<b>Field</b>	<b>Subfield or refinement</b>	<b>Entry</b>	<b>Explanation and action</b>
		COIN	Enter COIN if the end office uses the ANI ID to signify a coin call and the call origination is to be set to COIN.
		HOTEL	Enter HOTEL to indicate that the call origination is to be set by looking at the ST pulse and, if the TOPS trunk group is combined or CAMA tributary (field STATCLAS in table TRKGRP is set to COMBINED or CAMATRIB), then the calling service feature is to be set to HOTEL.
		INTC	Enter INTERCEPT if the calling service feature is to be set to STATION regardless of the originating trunk group and the call origination is to be set to INTC.
		MOBILE	Enter MOBILE if the calling service feature is to be set to STATION regardless of the originating trunk group and the call origination is to be set to MOBILE.
		SPECIAL	Enter SPECIAL to indicate that the call origination is to be set by looking at the ST pulse and, if the trunk is combined (field STATCLAS in table TRKGRP is set to COMBINED), then calling service feature is to be set by using the calling number as an index into table SPLDNID.

**BELLCAT** (continued)

## Field descriptions (Sheet 4 of 5)

Field	Subfield or refinement	Entry	Explanation and action
		STATION	Enter STATION to indicate one of the following: <ul style="list-style-type: none"> <li>if the TOPS trunk group is combined or CAMA tributary (field STATCLAS in table TRKGRP is set to COMBINED or CAMATRIB), then the calling service feature and call origination are set by looking at the ST pulse.</li> <li>if the TOPS trunk group is class of service lookup (field STATCLAS in table TRKGRP is set to DNLOOKUP), then the calling service feature is set by looking in table SPLDNID using the calling number as an index and the call origination is set by looking at the ST pulse.</li> </ul>
		TRBLINTC	Enter TRBLINTC if the calling service feature is set to STATION and the call origination is set to intercept. For TRBLINTC, the intercept call type is set to trouble or special intercept.
ANIRROUTE		see subfield	Automatic number identification route. This field consists of subfield ROUTEID.  <b>Note:</b> This field overrides any routing information derived from the called number and it is used to send the call to a position or an outgoing trunk.
	ROUTEID	N or T	Routing ID selector. Enter N if no route is specified in this table and any routes previously defined (STDPRTCT) remains in effect. No refinements require datafill.  Enter T if the route is to chosen by another routing table and datafill refinement TABLEID.
TABLEID		see subfield	Table identification. This field consists of subfield TABID.

**BELLCAT** (continued)**Field descriptions (Sheet 5 of 5)**

Field	Subfield or refinement	Entry	Explanation and action
KEY	TABID	OFRT, TOPS, AOSS (-BCS35)	Table name. Enter the route table name.  <b>Note 1:</b> AOSS is only valid up to and including BCS35.  <b>Note 2:</b> Entries outside the range indicated for this field are invalid.
		alphanumeric (up to 8 characters) or 0 to 1023	Key. If the entry in subfield TABID is AOSS or TOPS, enter a call type code defined in table AOSS or table TOPS, respectively. If the entry in subfield TABID is AOSS, that intercept calls on all combined trunk groups route to the Auxiliary Operator Services System (AOSS).  If the entry in subfield TABID is OFRT, enter the route reference index of the route list in table OFRT to which translation is to route.
SCRNIDX		0-100	Screening index. This field is an index into table RESTBIL (TA call) or DARSTBIL (DA call). This field supports a check of billing restrictions based on the incoming ANI ID digits for BELL signaling. This field is used if table TOPSTOPT field ANIIDSCR = Y, table TRKGRP field SIGTYPE = BELL, and no other restrictions apply to the call.

**Datafill example**

The following example shows sample datafill for table BELLCAT.

**MAP display example for table BELLCAT**

ANI	FORMAT	CLGSERV	ROUTE	SCRNIDX
0	ANI	STATION	N	10

## **BELLCAT** (end)

---

### **Table history**

#### **TOPS12**

The feature Calling Restriction for Wholesaling (59006832), UNBN0006, adds field SCRNIIDX.

#### **BCS36**

Tables OFRT and TOPS were added to the datafill sequence. Entry AOSS was removed for BCS36 and up from subfield TABID.



---

**BGDATA**

---

**Table name**

Business Group Data Table

**Functional description**

Table BGDATA is used to store information relating to multiswitch business groups (MBG).

Multiswitch business groups are Integrated Business Network (IBN) customer groups that are defined in more than one DMS central office switch. The MBG feature allows the same IBN features to be used on many different switches linked together through the use of Common Channel Signaling 7 (CCS7) facilities, using ISDN user part (ISUP) IBN trunks.

A single node can have up to eight possible mappings from a physical directory number (DN) to an MBG DN.

**Datafill sequence and implications**

The following tables must be datafilled before table BGDATA.

- CUSTENG
- TOFCNAME

Office parameter MAX\_MBG\_LINES controls the upper limit for MBG lines. The default value of this parameter in table OFCOPT is 1. This allows the addition of up to 99 MBG lines.

**Table size**

0 to 8000 tuples

**BGDATA** (continued)**Datafill**

The following table lists datafill for table BGDATA.

**Field descriptions (Sheet 1 of 5)**

<b>Field</b>	<b>Subfield or refinement</b>	<b>Entry</b>	<b>Explanation and action</b>
BGID		see subfields	<i>Business group identifier</i> This field consists of subfields LOCATION and GRPNUM.
	LOCATION	LOCAL	<i>Location</i> This subfield specifies the location of the business group to which MBG is to be assigned. Enter LOCAL.
	GRPNUM	0 to 4 194 303	<i>Group number</i> This subfield specifies the business group to which MBG is to be assigned. Enter a value from 0 to 4 194 303.
BGXLA		see subfields	<i>Business group translator</i> This field is a vector of up to eight multiples of subfields AREACODE, OFCCODE, XFERCNT, and MBGCODE. This field is used to map the physical DN to an MBG DN. The default value is \$.
	AREACODE	3-digit code	<i>Area code</i> This subfield specifies the serving the numbering plan area. Enter the three-digit code.
	OFCCODE	1- to 7-digit code	<i>Office code</i> This subfield specifies the office code. Enter the 1- to 7-digit code.
	XFERCNT	0 to 8	<i>Transfer count</i> This subfield specifies the number of digits to transfer when converting a public DN to an MBG DN. Enter a value from 0 to 8.
	MBGCODE	up to 10 digits	<i>Multiswitch business group code</i> This subfield specifies the digits that replace the area and office codes. Enter up to 10 digits.

**BGDATA** (continued)

## Field descriptions (Sheet 2 of 5)

Field	Subfield or refinement	Entry	Explanation and action
OPTIONS		see subfield	<p><i>Options</i> This field consists of subfield OPTION.</p>
	OPTION	CUSTGRP and BILLDN, BGMDR, DSR, FACTYPE, NUMDIGS, SMDR, FIXPRIV	<p><i>Option</i> This subfield specifies the option assigned to a business group. Enter CUSTGRP and any of the other options.</p> <p>Enter CUSTGRP to specify that an existing IBN customer group is to be associated with the business group, and datafill refinements CUSTGRP, MBG, NUMLINES, INTRAGRP, LSCFN, and LSCINCPT.</p> <p><b>Note:</b> If the BGID is LOCAL 1 and option CUSTGRP is datafilled, the following message displays (but the assignment is not prohibited):</p> <p>WARNING: LOCAL 1 IS RESERVED FOR PUBLIC NETWORK IDENTIFIER. THE CUSTGRP OPTION SHOULD NOT BE ASSIGNED TO LOCAL 1.</p> <p>Enter BILLDN to specify the billing DN of MBG calls and datafill refinement DN.</p> <p>Enter BGMDR to specify that business group message detail recordings are to be generated for all calls that originate from a line and terminate to an MBG trunk. No further refinements need datafill.</p> <p>Enter DSR to enable the distinctive ringing option for calls originating from the specified customer group. No further refinements need datafill.</p>

**BGDATA** (continued)

**Field descriptions (Sheet 3 of 5)**

Field	Subfield or refinement	Entry	Explanation and action
			<p>Enter FACTYPE to enable special billing for the specified customer group, and datafill refinement FACTYPE.</p> <p>Enter FIXPRIV to set the LPII field to Fixed Line Privileges and the Line Privileges field to 00 for each party information present in the BG parameter. The NCOS is not included in the message.</p> <p>Enter NUMDIGS to specify the number of location digits used in the customer group network, and datafill refinement NUMLDIGS.</p> <p>Enter SMDR to enable Station Message Detail Recording for calls originating from the specified customer group. No further refinements need datafill.</p>
<p>If OPTION is set to CUSTGRP, datafill refinements CUSTGRP, MBG, NUMLINES, INTRAGR, LSCFN, and LSCINCPT.</p>			
	CUSTGRP	alphanumeric (1 to 16 characters)	<p><i>Customer group</i> This refinement specifies the name of the IBN customer group that is to be associated with the business group. The customer group must be defined in table CUSTENG first.</p>
	MBG	Y or N	<p><i>Multilocation business group services</i> This refinement specifies whether all the lines in the customer group are to have access to the MBG services. Enter Y or N.</p>
	NUMLINES	0 to 65 535	<p><i>Number of lines</i> This read-only refinement displays the number of primary DNs (that is, the number of lines) in the customer group. (Secondary DNs are not counted as MBG lines.)</p>

**BGDATA** (continued)

## Field descriptions (Sheet 4 of 5)

Field	Subfield or refinement	Entry	Explanation and action
	INTRAGRP	Y or N	<i>Intragroup</i> This refinement specifies the interaction of the feature with the MBG trunk. Enter Y if the call is intragroup. Otherwise, enter N.
	LSCFN	0 to 255	<i>Line screening code flag number</i> This refinement specifies the line screening code associated with the MBG trunk. If the line screening code of a caller is not in the group of codes associated with the MBG trunk, the caller cannot make an MBG call. Enter a value from 0 to 255.
	LSCINCPT	0 to 63	<i>Line screening code flexible intercept</i> This refinement specifies the treatment number used in table IBNTREAT when access to an MBG trunk is blocked by a line screening code. Enter a value from 0 to 63.
If OPTION is set to BILLDN, datafill refinement DN.			
	DN	1- to 11-digit value	<i>Directory number</i> This refinement specifies the billing DN for all calls originating from MBG trunks that have an associated BG parameter. Enter a 1- to 11-digit value.
If OPTION is set to NUMDIGS, datafill refinement NUMLDIGS.			
	NUMLDIGS	1 to 5	<i>Number of location digits</i> This refinement specifies the number of location digits in the customer group. Enter a value from 1 to 5.

**BGDATA** (continued)

**Field descriptions (Sheet 5 of 5)**

Field	Subfield or refinement	Entry	Explanation and action
If OPTION is set to FACTYPE, datafill refinement FACTYPE.			
	FACTYPE	CCSA, ETS, FX, or TDMTT	<p><i>Facilities (special billing) type</i> This refinement specifies the type of special billing for the customer group.</p> <p>Enter CCSA to generate a call code 021 record, structure codes 0001, 0002, and 0101.</p> <p>Enter ETS to generate a call code 085 record, structure codes 001, 002, and 0101.</p> <p>Enter FX to generate a call code 011 record, structure codes 0500, 0001, 0002, and 0101.</p> <p>Enter TDMTT to generate a call code 032 record, structure codes 0025 and 0125.</p>

**Datafill example**

The following example shows sample datafill for table BGDATA.

**MAP display example for table BGDATA**

BGID		BGXLA OPTIONS	
LOCAL	1	(613 722 5 999)\$	
(NUMDIGS 3)	(CUSTGRP COMKODAK Y 254 Y 0 0)	(FACTYPE CCSA)\$	

**Table history**

**NA007**

Added option FIXPRIV and the LOCAL 1 warning under subfield CUSTGRP as a result of design activity AF6497 (MBG/IBN ISUP Redirection Enhancements).

**BGDATA** (end)

---

**BCS36**

Clarified entries in refinements LSCINCPT and FACTYPE. Added invalid range statement to subfield GRPNUM. Clarified field OPTIONS and added subfield OPTION.

## BGLOCN

---

### Table name

Business Group Location Table

### Functional description

Table BGLOCN defines the mapping from the location codes of the operating company's network to the routing directory numbers (DN) in the public numbering plan.

### Datafill sequence and implications

Table BGDATA must be datafilled before table BGLOCN.

Assuming that the required group exists in table CUSTNAME, it must be associated with a business group identifier (BGID) in field BGID in table BGDATA. The associated tuple in table BGDATA must specify the number of digits (field NUMDIGS) in the location code (field LOCNCODE) of table BGLOCN.

The same value of field ROUTEDN can be associated with many location codes. Each location code can only have a single ROUTEDN datafilled against it.

### Table size

0 to 8191 tuples

### Datafill

The following table lists datafill for table BGLOCN.

#### Field descriptions (Sheet 1 of 2)

Field	Subfield or refinement	Entry	Explanation and action
BGLOCNKY		see subfields	<i>Business group location key</i> This field consists of subfields CUSTGRP and LOCNCODE.
	CUSTGRP	alphanumeric (1 to 16 characters)	<i>Customer group</i> Enter a customer group. The customer group must be datafilled in field BGID in table BGDATA.



**BGLOCN** (continued)

## Field descriptions (Sheet 2 of 2)

Field	Subfield or refinement	Entry	Explanation and action
ROUTEDN	LOCNCODE	0 to 9 (up to 5 digits)	<i>Location code</i> Enter the location specified by the entry in field NUMDIGS in table BGDATA.
		0 to 9 (up to 18 digits)	<i>Routing directory number</i> Enter the digits used to route a call in the customer group's network through the public network.
REPDIGS		0 to 15	<i>Replaced digits</i> Enter the number of trailing digits that are removed from the ROUTEDN string and replaced with the final digits of the dialed sequence.
OPTIONS		see subfields	<i>Option list</i> This field consists of subfield OPTION.
	OPTION	ALBTERM or \$	<i>Option</i> Enter ALBTERM for the alternate terminating number and datafill refinements TERMNUM and AREPDIGS. Enter \$ if no option is required. No further datafill is needed.
	TERMNUM	0 to 9 (up to 18 digits)	<i>Terminating number</i> Enter the alternate automatic message accounting (AMA) terminating number.
	AREPDIGS	0 to 15	<i>Replaced digits</i> Enter the number of digits, counting from the right, that are to be deleted from subfield TERMNUM and replaced by the same number of right-most digits from the called generic address parameter (GAP).

**Datafill example**

The following example shows sample datafill for table BGLOCN.

---

**BGLOCN** (end)

---

**MAP display example for table BGLOCN**

BGLOCNKY	ROUTEDN	REPDIGS	OPTIONS
ENTERPRISE 8254 (ALTBTERM	12345678910 1645 2)		4 \$

**Table history****BCS36**

The following changes were implemented:

- Number of digits allowed in subfield LOCNCODE was clarified.
- Field OPTIONS and subfield OPTION were added.
- Field ALTBTERM was deleted.
- Entry \$ was added to subfield OPTION.

**BCS34**

Table BGLOCN was introduced.

---

**BILLCODE**

---

**Table name**

Billing Code Table

**Functional description**

Table BILLCODE lists the following information for each Nxx central office code, special billing code, and wide area telephone service (WATS) originating code that is allowed to originate direct distance dialing (DDD) calls over incoming lines from North Electric AMR5 or centralized automatic message accounting (CAMA) trunk groups:

- the name of the local calling area that is assigned to the code if local calling area screening is required
- the name of the class of service assigned to the code if class of service screening is required
- the actual code and numbering plan area (NPA) that is entered on the automatic message accounting (AMA) tape
- the charge class applicable to the code

If an incoming CAMA trunk group carries operator number identification (ONI) traffic, one of the entries for the trunk group specifies the local calling area and class of service screening tables to which ONI calls are to be routed.

The Nxx code for the entry for ONI calls is 000. This entry can be located at any position among the entries for the trunk group (for example, it does not have to be the first entry for the trunk group in table BILLCODE).

Standard pretranslation is defined on a trunk group basis. If standard pretranslation is required, the appropriate subtable name is defined in the input for the incoming calls from AMR5 or CAMA trunk groups.

**Datafill sequence and implications**

The following tables must be datafilled before table BILLCODE.

- CHARGE
- CHARGEI
- CLLI
- LCASCRN or LCAINFO (if using LCA 6-digit screening)
- DPCTSCRN (if using table LCAINFO)
- LCA6SCRN (if using table LCAINFO)

**BILLCODE** (continued)

- SCRNCCLAS
- TRKGRP

**Table size**

The memory allocated for table BILLCODE is equal to the values of field NOBILLCD for all incoming calls from AMR5 or CAMA trunk groups.

**Datafill**

The following table lists datafill for table BILLCODE.

**Field descriptions (Sheet 1 of 2)**

Field	Subfield or refinement	Entry	Explanation and action
CLLI		alphanumeric (1 to 16 characters)	<i>Common language location identifier</i> Enter the code assigned to the trunk group in table CLLI.
BILLCODE		alphanumeric (3 digits)	<i>Billing code</i> The codes entered here can include all central office Nxx codes, special billing codes, and wide area telephone service (WATS) originating codes that originate direct distance dialing (DDD) calls over the trunk group.  If the entry is for ONI screening, enter 000.
LCANAME		alphanumeric (1 to 8 characters) or NLCA	<i>Local calling area screening name</i> If screening of local NNX codes is required, enter the name of the local calling area screening name assigned to the trunk group. Enter a local calling area screening name provisioned in either table LCASCRN or LCAINFO. If screening of local NNX codes is not required, enter NLCA.
SCRNCL		alphanumeric (4 characters)	<i>Class of service screening table name</i> If screening by class of service is required, enter the name of the class of service screening subtable assigned to the trunk group.  If screening by class of service is not required, enter NSCR (see table CLSVSCRC).

**BILLCODE** (end)**Field descriptions (Sheet 2 of 2)**

Field	Subfield or refinement	Entry	Explanation and action
ACTUALBC		numeric (6 digits)	<i>Actual billing code</i> Enter the actual billing code (NPA + Nxx) that is entered on the automatic message accounting (AMA) tape. If the entry is for ONI screening, enter 000000.
CHGCLSS		alphanumeric (4 characters)	<i>Charge class</i> Enter the charge class in the toll entry code table to which the billing code is assigned. Entries outside this range are invalid. If the entry is for ONI screening, enter NONE.

**Datafill example**

The following example shows sample datafill for table BILLCODE.

**MAP display example for table BILLCODE**

CLLI	BILLCODE	LCANAME	SCRNCL	ACTUALBC	CHGCLSS
ICADCM	621	LOC00001	TCA9	613621	CAMO

**Table history****NA010**

Modified the LCANAME field to accept from 1 to 8 characters.

## BITGPER

---

### Table name

Busy/Idle Trunk Group Period Table

### Functional description

Table BITGPER provides a method to specify time interval values. The system uses these values to generate the B100 log for trunks and alarm conditions associated with this log. The system generates the log and alarm when a trunk is busy or idle for a period that exceeds the detection period. Table BITGPER defines this period. The specification of detection periods occurs for each trunk group.

Entries in field CLLI must correspond to correct trunk group common language location identifiers (CLLI) in table CLLI.

The system does not generate B100 logs and alarms for an ALWAYS BUSY condition. This event occurs when field BUSPER is set to zero for the monitored trunk group.

The system does not generate B100 logs and alarms for an ALWAYS IDLE condition. This event occurs when field IDLPER is set to zero for the monitored trunk group.

You can enter the value of one of the BUSPER and IDLPER fields as (0) zero for a specified trunk group.

### Datafill sequence and meaning

You must enter data in table CLLI before you enter data in table BITGPER.

### Table size

0 to 8192 tuples

Table BITGPER can have a maximum of 8192 defined trunk groups. Each entered trunk group requires one tuple. The number of trunk groups with datafill entry determines the memory requirements for this table.

**BITGPER** (continued)**Datafill**

The datafill for table BITGPER appears in the following table.

**Field descriptions**

Field	Subfield or refinement	Entry	Explanation and action
CLLI		alphanumeric (1 to 16 characters)	<i>Common language location identifier.</i> Enter the CLLI for the specified trunk group. This field is the key to table BITGPER.
IDLPER		numeric 0, 6, 12, 18, or 24	<i>Idle period.</i> Enter the detection period for always idle trunks in the specified trunk group. This period is specified in hours. The default value is 24. Entry values other than 0, 6, 12, 18 and 24 are not correct.
BSYPER		numeric 0, 6, 12, 18, or 24	<i>Busy period.</i> Enter the detection period for always busy trunks in the specified trunk group. This period is specified in hours. The default value is 12. Entry values other than 0, 6, 12, 18 and 24 are not correct.

**Datafill example**

Sample datafill for table BITGPER appears in the following example.

This example has a trunk group with a CLLI of INTL100Q. The system monitors the CLLI for idle trunk periods that exceed 24 h. The system monitors the CLLI for busy trunk periods that exceed 12 h.

**MAP example for table BITGPER**

CLLI	IDLPER	BSYPER
INTL100Q	24	12

**Table history****BCS35**

Table size maximum increased to 8192.

**BITGPER** (end)

---

**BCS34**

Table BITGPER was introduced in BCS34.



---

**BLDDATA**

---

**Table name**

Build Data (BLDDATA)

**Functional description**

A dump and restore of a datafill table can occur more than one time during the one-night process (ONP). When this event occurs, the table is a recursive table. A table that the system identifies as a recursive table informs the ONP. The table informs the ONP that when a tuple fails during the transfer, the tuple must transfer later during the data transfer. Movement of these tables occurs again when other tables execute the post table procedures. The system cannot restore one tuple of a recursive table the first time. Restoration of the *entire* table must occur next time.

Table BLDDATA stores tuples for restoration during the ONP data transfer process. The restore side of the process release can match the release number of the specified tuple in table BLDDATA. When this event occurs, the data transfer proceeds in table BLDDATA to restore the tuple to the appropriate table.

Table BLDDATA reduces the time required to apply data requests in the loadbuild cycle. This reduction occurs when the operating company enter a previous software release with new data. In addition, this table reduces the probability of errors. To reduce errors, the table allows the addition of tuples that use command NEWDATA:INCLUDE. The table limits this time because the table provides a structure to facilitate the transfer of the tuple. This table integrates the tuple into memory. The table does not integrate the tuple in a DMOPRO type file.

**Note:** Table BLDDATA is a read-only table and is not for end users. Northern Telecom enters data in this table. Northern Telecom technicians must perform modifications to this table.

**Datafill sequence and meaning**

You do not need to enter data in other tables before you enter data in table BLDDATA.

**Table size**

Table BLDDATA uses segmented store structure. The system creates this table by continuous adjustment. The system increases the table when the entry of a data request cannot occur in a previous software release. The minimum size of this table is one tuple. This table has 80 bytes of store.

**BLDDATA** (continued)

The maximum number of tables is 1400. Each table has a representation in a tuple ID structure of 80 bytes. The maximum size of the link list of tuples is 64k bytes of segmented store.

**Datafill**

Datafill for table BLDDATA appears in the following table.

**Field descriptions**

Field	Subfield or refinement	Entry	Explanation and action
BLDKEY	see subfields		Building key. This field has subfields TABNAME, TUPLENUM and PARTNUM.
	TABNAME	alphanumeric	Table name. This subfield identifies the name of the table from which the addition of tuples to table BLDDATA originates.
	TUPLENUM	positive integers	Tuple number. This subfield identifies the number of the tuple of the table entered in subfield TABNAME. This value represents the numerical order of the tuple in the specified table.
	PARTNUM	positive integers	Part number. This subfield identifies the part number of the tuple of the table entered in subfield TABNAME. This value represents the numerical order of the part of the specified tuple.
RELNUM		numeric	Release number. This field identifies the software release number.
OPERATIN		ADD, DEL, PUT, UPD	Operation. This field determines the treatment of the tuple in the table. The ADD refers to the addition of the tuple to the specified table. The DEL refers to the deletion of the tuple in the specified table. The UPD refers to the update of a tuple in the specified table. The PUT refers to the replacement of a tuple.
TUPDATA			Tuple data. The entry in TABNAME determines this field. The tuple data corresponds to the name of the table specified in TABNAME.

**BLDDATA** (end)**Datafill example**

Sample datafill for table BLDDATA appears in the following example.

**MAP example for table BLDDATA**

	BLDKEY	RELNUM	OPERATN TUPDATA
	LTCPSINV 1 1	TOPO4	PUT
TMS 2 N 0 DS1 DEFAULT N 1 DS1 DEFAULT N 2 DS1 DEFAULT N 3 DS1 DEFAULT N			

**Table history****BASE03**

Initial release of this table is in accordance with Workstation to Workstation Data Transfer in BASE03.

**Additional information**

When a request of new data for a table occurs, the system dumps the table in a DMOPRO type file. This file contains previous and current data. When the user executes the INCLUDE command, the system opens the file and performs a read.

Type version checking occurs. When the system does not detect a mismatch in the type versions, the file is RESTABED into the previous software release. When the system detects a type version mismatch, the system creates table BLDDATA.

When the start of the dump and restore process begins, the release side attempts to restore the tuples in table BLDDATA. This event occurs after the restoration of each corresponding table.

**Note:** The restore process of table BLDDATA tuples can occur after the restoration of each table. The LOADBUILD report reports error messages associated with tuples. In addition to the error messages, the LOADBUILD report identifies the defective tuple.

## **BLMTHRSH**

---

### **Table name**

Basic Line Monitoring Threshold Table

### **Functional description**

Table BLMTHRSH acts as a look-up table for line-monitoring threshold values. Table BLMTHRSH is used by the central control (CC) to provide layer 1 surveillance of ISDN two binary one quaternary (2B1Q) subscriber loops. Basic line monitoring consists of performance monitoring (PM) of cyclical redundancy checks (CRC) and block error events. The threshold values contained in table BLMTHRSH are used by the CC to generate alarm reporting logs when the values are exceeded.

Table BLMTHRSH is used by table LNTHRSH to recover threshold values during dump and restore. The key field is BLMIDX.

Threshold values are measured in errored seconds. An errored second is a 1-s interval in a single direction of transmission that contains one or more CRC violations. A severely errored second contains CRC violations that exceeds a fixed value (set at 3 in the line card ROM).

### **Datafill sequence and implications**

There is no requirement to datafill other tables prior to table BLMTHRSH.

### **Table size**

16 tuples

Table size is fixed; tuples cannot be added or deleted.

**BLMTHRSH** (continued)**Datafill**

The following table lists datafill for table BLMTHRSH.

**Field descriptions**

Field	Subfield or refinement	Entry	Explanation and action
BLMIDX		0 to 15	<i>Basic line monitoring index</i> This field is the key to table BLMTHRSH. The default value for the first tuple is 0 (zero).
ESHOUR		1 to 4095	<i>Errored seconds for each hour</i> This is the threshold value of the errored seconds for each hour. The default value for the first tuple is 40.
ESDAY		1 to 16383	<i>Errored seconds for each day</i> This is the threshold value of the errored seconds for each day. The default value for the first tuple is 100.
SESHOUR		1 to 4095	<i>Severely errored seconds for each hour</i> This is the threshold value of the severely errored seconds for each hour. The default value for the first tuple is 10.
SESDAY		1 to 16383	<i>Severely errored seconds for each day</i> This is the threshold value of the severely errored seconds for each day. The default value for the first tuple is 25.

**Datafill example**

The following example shows sample datafill for table BLMTHRSH.

This example shows the default entries set up in table BLMTHRSH on initial installation. Entries 1 to 15 do not represent engineered values and are provided with the intention that they will be changed to meet the engineering requirements of the operating company.

**BLMTHRSH** (continued)**MAP display example for table BLMTHRSH**

BLMIDX	ESHOUR	ESDAY	SESHOUR	SESDAY
0	40	100	10	25
1	1	1	1	1
2	2	2	2	2
3	3	3	3	3
4	4	4	4	4
5	5	5	5	5
6	6	6	6	6
7	7	7	7	7
8	8	8	8	8
9	9	9	9	9
10	10	10	10	10
11	11	11	11	11
12	12	12	12	12
13	13	13	13	13
14	14	14	14	14
15	15	15	15	15

**Table history****BCS35**

Table BLMTHRSH was introduced.

**Supplementary information**

This section provides information on datafilling table BLMTHRSH for specific applications, and product descriptive information related to table BLMTHRSH.

**BLMTHRSH** (end)

---

Duplicate tuples cannot be entered.

This table supports only ISDN U-loops provided by line card NTB27AA  
(2B1Q U-interface ISDN line card).

## BNMCUST

---

### Table name

Business Network Management Customer Table

### Functional description

Table BNMCST maps customer names to their customer groups. All customer groups are unique, that is, only one assignment of a customer group to a customer is allowed. There can be many customer groups mapped to one customer name, but a customer group can only be assigned once to a particular customer name. If a customer group is deleted, all the customer group information must be removed for the whole Business Network Management (BNM) system.

### Datafill sequence and implications

Table CUSTENG must be datafilled before table BNMCUST.

The following restrictions are applied to table BNMCUST:

- Table command CHA (change) is not used with table BNMCUST since each tuple contains only the key and no other field.
- Addition of an existing customer group to field CUSTGRP results in the automatic removal of the previous tuple that contains the existing customer group.

### Table size

0 to 4000 tuples

### Datafill

The following table lists datafill for table BNMCUST.

#### Field descriptions (Sheet 1 of 2)

Field	Subfield or refinement	Entry	Explanation and action
BNMCUST		see subfields	<i>Business network management customer</i> This field consists of subfields CUSTNAME and CUSTGRP.



**BNMCUST** (end)**Field descriptions (Sheet 2 of 2)**

Field	Subfield or refinement	Entry	Explanation and action
	CUSTNAME	alphanumeric (up to 16 characters)	<i>Customer name</i> Enter the customer name.
	CUSTGRP	alphanumeric (up to 16 characters)	<i>Customer group</i> Enter the customer group. The customer group must be defined in table CUSTENG and in the Business Network Management (BNM) system.

**Datafill example**

The following example shows sample datafill for table BNMCUST.

**MAP display example for table BNMCUST**

CUSTNAME	CUSTGRP
CUSTNAME1	CUSTGRPA

## **BNSAGRMT**

---

### **Table name**

Billed Number Screening Agreement Table

### **Functional description**

Each service provider can have different billing agreements with a given service provider based on the billing method. New table BNSAGRMT provides tracking of billing agreements separately based on Billed Number Screening. Table BNSAGRMT lists the billing agreements between an originator's billing agreement group and a billed-to AO or BSP SPID for billed number screening.

### **Datafill sequence and meaning**

Enter datafill in the tables SPID and BAGNAME before table BNSAGRMT.

### **Table size**

0 to 32765 tuples.

### **Datafill**

The table that follows lists datafill for table BNSAGRMT.

### **Field descriptions (Sheet 1 of 2)**

<b>Field</b>	<b>Subfield</b>	<b>Entry</b>	<b>Explanation and action</b>
BNSKEY		see subfields	Billing number screening key. This field is the key to the table and consists of subfields ORIGGRP and BILLSPID. The presence of a tuple in this table indicates an agreement exists between the billing agreement group of the originator and the billed-to SPID.

**BNSAGRMT** (end)**Field descriptions (Sheet 2 of 2)**

Field	Subfield	Entry	Explanation and action
	ORIGGRP	name from table BAGNAME	Originating group. This field is the billing agreement group name associated with the originating party. For an LEC call, this group name is associated with a SPID in table SPIDDB. For a carrier call, this group name is associated with a CIC in table TOPEACAR. The name must be defined in table BAGNAME.
	BILLSPID	value from table SPID	Billed-to SPID. Enter the AO or BSP SPID of the billed-to party/entity. The SPID must be defined in table SIPD. The SPID returned from the LIDB query is compare to this field to screen for billing agreements.

**Datafill example**

The figure that follows shows sample datafill for table BNSAGRMT.

**MAP display example for table BNSAGRMT**

BNSKEY	
OPRBNSGRP	LECD
OPRBNSGRP	LECE
OPRBNSGRP	C123
OPRBNSGRP	C456
LECBNSGRP	LECC
LECBNSGRP	LECF
LECBNSGRP	C123
LECBNSGRP	C333

**Table history****TOPS13**

This table was added by feature 59011929 in functionality Screening for Billing Agreement, UNBN0007..

**Additional information**

None.

## BNSINFO

---

### Table name

Billed Number Screening Information Table

### Functional description

This table is used for BNS queries. The table is indexed by the NPA-NXX (NPA plus the billed number) and it contains an index into table BNSPARMS, which contains datafillable fields relating to BNS queries and responses (EABS only - SS7 rather than SS6 queries). This index enables more than one BN to index the same tuple in table BNSPARMS. If a given billed number has no match in this table, then tuple 0 (the default tuple) in table BNSPARMS is used. The key field is BNSDIGS.

### Datafill sequence and implications

Table BNSPARMS must be datafilled before table BNSINFO. The value entered in field PARMSIDX must be datafilled first in field ISX of table BNSPARMS.

### Table size

0 to (see note)

*Note:* This table uses digilators and therefore the maximum number of tuples depends on how the table is datafilled, and this varies with each application.

If memory conservation is important, band tuples to reduce memory requirements.

**BNSINFO** (continued)**Datafill**

The following table lists the datafill for table BNSINFO.

**Field descriptions**

Field	Subfield or refinement	Entry	Explanation and action
BNSDIGS		see subfield	Billed number digits. This field is the key to the table and consists of subfield DIGILATOR_KEY.
	DIGILATOR_KEY	0 to 9 (up to 18 digits)	Billed number digits. Enter the numbering plan area (NPA) and the billed number, or a portion of the number sufficient to cover a range of applicable numbers (NPA-Nxx digilator).  This field is a digilator, similar to subtable STDPRTCT.STDPRT. Therefore, it is not possible to datafill two tuples that begin with the same digits and have different digit lengths. For example, tuples 23 23 and 231 231 cannot be used in the same table.
PARMSIDX		0 to 300	Parameters Index. An index into table BNSPARMS. Entries must exist in field IDX in table BNSPARMS. This field allows more than one issuerid to index the same tuple in table BNSPARMS.

**Datafill example**

The following example shows sample datafill for table BNSINFO.

**MAP display example for table BNSINFO**

BNDIGS	PARMSIDX
212220	1
202851	2
9192	1
9195	2
203	2
3	4

## **BNSINFO** (end)

---

### **Table history**

#### **BCS36**

Field BNSDIGS was split into field BNSDIGS and subfield DIGILATOR\_KEY.

#### **BCS34**

Table BNSINFO was introduced. And modified by feature AN0342 in NTX825AB, TOPS EABS.

---

## BNSPARMS

---

### Table name

Billed Number Screening Parameters Table

### Functional description

Table BNSPARMS is used for Billed Number Screening (BNS) queries and provides an index into table ACCSERR for both public and private phones. This allows different handling (for the same error codes) for public and private phones.

*Note:* A telephone is considered a private phone if the call is classed as station. For any other class (i.e., hotel, restricted, coin), the phone is considered to be a public phone.

The datafill in table BNSPARMS determines how the Traffic Operator Position System (TOPS) reacts to abnormal line information database (LIDB) queries including time-outs, signaling connection control port (SCCP) errors, and transaction capabilities application part (TCAP) of CCS7 protocol errors. Table BNSPARMS uses table C7GTTYPE for global translation (GT) of billed numbers (BN). Table BNSINFO uses table BNSPARMS to provide a single index into table ACCSERR for multiple tuples entered in table BNSINFO. The key field is IDX.

Fields GTTNAME and TIMEOUT are moved here from table INTCCFMT. They provide Global Title Translations and timeout for BNS, LIDB queries. These parameters can be specified on an NPA-NXX basis.

One default tuple is datafilled in this table (via IPL restart code), with an IDX of 0. This tuple is used by EABS when a tuple cannot be found in table BNSINFO (and table BNSPARMS) for a given calling card or billed number.

Dump and restore copies existing table values.

### Datafill sequence and implications

The following tables must be datafilled before table BNSPARMS.

- ACCSERR
- C7GTTYPE

Datafill table C7GTTYPE prior to datafilling a string (other than the empty string) in field GTTNAME.

Table BNSPARMS must be datafilled before table BNSINFO.

**BNSPARMS** (continued)**Table size**

1 to 301 tuples

**Datafill**

The following table lists the datafill for table BNSPARMS.

**Field descriptions (Sheet 1 of 3)**

Field	Subfield or refinement	Entry	Explanation and action
IDX		see subfield	Index. This field is the key to the table and consists of subfield BNSPARMS_TUPLE_KEY.
	BNSPARMS_TUPLE_KEY	0 to 300	Table BNSPARMS key. Index into table from table BNSINFO, field PARMSIDX. Enter the index for the tuple.  The default value is 0 (zero). The default value is used by the exchange alternate billing service (EABS) if a tuple for a given calling card or billed number (BN) cannot be found in tables BNSINFO and BNSPARMS.
VALAREA		see subfield VALTYPE	Validation area. This field is composed of selector field VALTYPE and a set of other subfields based on the value of VALTYPE.



**BNSPARMS** (continued)

## Field descriptions (Sheet 2 of 3)

Field	Subfield or refinement	Entry	Explanation and action
	VALTYPE	MANUAL, BLK, SDB, BVC, or LIDB	<p>Validation type. Selector VALTYPE determines the method of validating the collect or third number. Only when VALTYPE=LIDB do the remaining fields (GTTNAME, TIMEOUT, PUBCOLL, PRIVCOLL, PUB3RD, and PRIV3RD) appear. The default is LIDB. The entries are defined as follows:</p> <ul style="list-style-type: none"> <li>MANUAL - Inward validation is required by an operator. No further datafill is required.</li> <li>BLK - Table BNSPARMS is indexed by an alternate billing number, then alternate billing to this number is blocked. No further datafill is required.</li> <li>SDB - Validation by network services database. No further datafill is required.</li> <li>BVC - Billing validation center. No further datafill is required.</li> <li>LIDB - Validation by line information database. Datafill refinements GTTNAME, TIMEOUT, PUBCOLL, PRIVCOLL, PUB3RD, and PRIV3RD.</li> </ul> <p><b>Note:</b> The following fields (GTTNAME, TIMEOUT, PUBCOLL, PRIVCOLL, PUB3RD, and PRIV3RD) only appear if field VALTYPE=LIDB.</p>
	GTTNAME	string of up to 16 characters	<p>Global Title Translation Name. This value must match an entry in table C7GTTYPE, field GTTNAME. Table C7GTTYPE must be datafilled prior to datafilling a string (other than the empty string) in field GTTNAME of this table.</p> <p>The default value is ACCSGT, or BNSGT for Canada.</p>

**BNSPARMS** (continued)

## Field descriptions (Sheet 3 of 3)

Field	Subfield or refinement	Entry	Explanation and action
	TIMEOUT	0-255	<p>Timeout. Enter the time, in seconds, that the operator services system (OSS) waits for a response from a LIDB query on a card issuer basis. If the response is not received within this time, the OSS terminates its wait for the response.</p> <p>This field is useful because the time between the launch of a LIDB query and the receipt of the response message in the OSS may vary for different card issuers (which may use different LIDBs).</p> <p>The default value is 2.</p>
	PUBCOLL	0-254	<p>Public Collect. An index into table ACCSERR for a calling number from a public telephone and billing is collect.</p> <p>The default value is 1.</p>
	PRIVCOLL	0-254	<p>Private Collect. An index into table ACCSERR for a calling number from a private telephone and billing is collect.</p> <p>The default value is 1.</p>
	PUB3RD	0-254	<p>Public Third. An index into table ACCSERR for a calling number from a public telephone and billing is to a third number.</p> <p>The default value is 1.</p>
	PRIV3RD	0-254	<p>Private Third. An index into table ACCSERR for a calling number from a private telephone and billing is to a third number.</p> <p>The default value is 1.</p>

**Datafill example**

The following example shows sample datafill for table BNSPARMS.

**BNSPARMS** (end)**MAP display example for table BNSPARMS**

IDX	VALAREA
0	LIDB \$ 2 0 0 0 0
1	LIDB BNSGT \$ 2 4 4 2 2
299	BLK
300	MANUAL
301	SDB

**Table history****TOPS03**

Added fields VALAREA and VALTYPE, from feature AN0409 in TOPS Commercial Credit Card, ABS00008.

**BCS36**

Field IDX was split into field IDX and subfield BNSPARMS\_TUPLE\_KEY.

**BCS35**

Default values were revised by feature NC0342 in NTX825AB, TOPS EABS.

**BCS34**

Table BNSPARMS was introduced.

## BNSPROV

### Table name

Billed Number Screening by Provider

### Functional description

Table BNSPROV is used to obtain the index into table BNSPARMS for calls billed to a third number or a collect number. Table BNSPROV is used instead of table BNSINFO when the UNBN0104 SOC and LIDBYCIC fields are active, and the UNBUNDLING\_LIDB\_QUERY\_ROUTING parameter in table TOPSFTR is set to yes.

This table is created as a result of the LIDB Query Routing Based on CIC feature. The capability of determining which LIDB to query based on the Carrier Identification Code (CIC) and billing number associated with the call is provided by this feature. This functionality is activated on a per-CIC basis through table TOPEACAR, and only applies to calls originated from a carrier. Enhancements are also made to the release line trunk (RLT) protocol to signal the International organization for standardization (ISO) card information back to the DMS-250 in the facility request message (FAR).

### Datafill sequence and meaning

The value in field PARMSIDX must be defined in table BNSPARMS before datafilling in table BNSPROV. The datafill sequence is as follows:

- BNSPARMS
- LDBIDXNM
- TOPEACAR
- BNSPROV

### Datafill

The next table lists the datafill for table BNSPROV.

#### Description of table BNSPROV (Sheet 1 of 2)

Field Name	Subfield	Entry	Explanation
BNSKEY			Two part key consisting of the index from table TOPEACAR and the third or collect number.
	LIDBIDX	Up to eight alphanumeric characters.	Index from table TOPEACAR.

---

## BNSPROV (end)

---

### Description of table BNSPROV (Sheet 2 of 2)

Field Name	Subfield	Entry	Explanation
	BILLDIGS	Digits.	Enter the third or collect number.
PARMSIDX		Digits.	Provides the index into table BNSPARMS.

### Datavfill example

The next figure shows sample datavfill for table BNSPROV.

#### MAP display example for table BNSPROV

	BNSKEY	PARMSIDX
CAR111	20	0
CAR111	291	0
CAR111	3	0
CAR222	2	1
CAR222	3	1

### Table release history

Table BNSPROV is a new table for the TOPS16 release.

## **BRANDANN**

---

### **Table name**

Branding Announcements Table

### **Functional description**

Table BRANDANN provides the table DRAMTRK announcement common language location identifiers (CLLI) for both toll and assist (TA) and directory assistance (DA) calls for each operating company. The key to the table is a four-digit code representing either the operating company or a company for which the operating company is providing operator services.

Two announcement CLLIs can be datafilled for each four-digit code, one for TA branding announcements and one for DA. During a call, the CLLIs determine the appropriate announcement to play by acting as an index into table DRAMTRK.

For related information, refer to table BRANDOPT.

### **Datafill sequence and implications**

The following tables must be datafilled before table BRANDANN.

- ANNS
- CLLI

### **Table size**

0 to 400 tuples

A maximum of 200 company codes can be datafilled in table BRANDANN. This size is set at loadbuild and cannot be changed.

**BRANDANN** (continued)**Datafill**

The following table lists datafill for table BRANDANN.

**Field descriptions (Sheet 1 of 2)**

Field	Subfield or refinement	Entry	Explanation and action
CARNBEC		see subfields	Carrier or NBEC code. This field is the key to the table. It is composed of subfields CARNBEC_DIGS and ANN_TYPE.
	CARNBEC_DIGS	0000-9999	Carrier or NBEC code digits. Enter the interLATA carrier or NBEC code. There is no allocation restriction, i.e. any entry in the range can be a company or NBEC code. The carrier must be datafilled as SERV in table TOPEACAR.  In cases where the operating company has been contracted to provide operator services on behalf of another company, the code used to represent that company is chosen by the operating company.  Code 0000 is reserved to represent the operating company.
	ANN_TYPE	CARR or NBEC	Announcement type. Indicate the type of carrier code in subfield CARNBEC_DIGS.
TAANN		Y or N	Toll and assist announcement. If branding is desired for TA calls from this company, enter Y (yes). Otherwise, enter N (no). If this field is set to Y, datafill refinement TACLLI.
TACLLI		alphanumeric (1 to 16 characters)	Toll and assist CLLI. If the entry in field TAANN is Y, enter the CLLI name of the announcement trunk that is used to access the company's TA branding announcement in table DRAMTRK.
DAANN		Y or N	Directory assistance announcement. If branding is desired for DA calls from this company, enter Y. Otherwise, enter N. If this field is set to Y, datafill refinement DACLLI.

**BRANDANN** (continued)**Field descriptions (Sheet 2 of 2)**

<b>Field</b>	<b>Subfield or refinement</b>	<b>Entry</b>	<b>Explanation and action</b>
DACLI		alphanumeric (1 to 16 characters)	Directory assistance CLI. If the entry in field DAANN is Y, enter the CLI name of the announcement trunk that is used to access the company's DA branding announcement in table DRAMTRK.
CDANN		Y or N	Country direct announcement. Enter Y for branding of CD calls from this company or N for no branding. If set to Y, datafill refinement CDCLI.
	CDCLI	CLI datafilled in table DRAMTRK	Country direct CLI. If the entry in field CDANN is Y, enter the CLI name of the announcement trunk for the company's country direct branding announcement in table DRAMTRK.

**Datafill example**

The following example shows sample datafill for table BRANDANN.



**BRANDANN** (continued)**MAP display example for table BRANDANN**

	CARNBEC					
	TAANN					
		TACLLI				
			DAANN			
				DACLLI		
				CDANN		
					CDCLLI	
<hr/>						
0000	NBEC					
	Y					
		BLUBONNETBEL				
			Y			
				BLUBONNETBEL		
				N		
0221	CARR					
	N					
			Y			
				NCTDABRAND		
				Y		
					CD0221	
1142	NBEC					
	Y					
		WESTEXTEL				
			N			
				N		
1386	CARR					
	N					
			Y			
				BIGBENDBRAND		
				N		
2547	CARR					
	Y					
		PINEYWOODSTA				
			Y			
				PINEYWOODSDA		
				N		

**Supplementary information**

This section provides additional information related to table BRANDANN

**Error messages**

Attempts to datafill a CLLI for either a TA or DA announcement that is not in table ANNS will result in the following error message:

**BRANDANN** (end)

---

TABLE ANNS MUST BE DATAFILLED PRIOR TO THIS TABLE.

**Default datafill**

There is no default datafill for table BRANDANN. The table can remain empty until company codes are added to provide announcement trunk CLLIs for either TA branding announcements, DA branding announcements, or both.

**Table history**

**NA005**

Added fields CDANN and CDCLLI per functionality Auto Country Direct, ENSV0010.

**TOPS03**

Added field ANN\_TYPE per feature AN0883 in EA Carrier Code Expansion, OSEA0001.

---

**BRANDOPT**

---

**Table name**

Branding Options Table

**Overview**

For directory assistance (DA) or toll and assist (TA) calls, the tables shown in table 1 enable a branding announcement to be played to a user before connecting the user to Traffic Operator Position System (TOPS) operator services. The branding announcement can be used to give instructions to the user as well as the name of the company completing the call.

**Directory of operator-assisted call branding tables**

Table name	Form number	Form title
BRANDOPT	2905	Branding Options Table Record
BRANDANN	2904	Branding Announcements Table Record
NBECCODE	2906	Non-Bell Exchange Company Code Table Record

The following office parameters, located in table OFCENG, are associated with the call branding tables:

- TOPS\_BRAND\_OFFICE
- TOPS\_BRAND\_INWARDS
- TOPS\_BRAND\_DISPLAY

If a call is 0-, 0+, or 1+ coin or hotel, an operator is required to assist in the call. When the call is received, all digits are collected and a customized branding announcement can be played to the calling party. The call is then connected to an operator, placed in a queue to wait for an available operator, or connected to an automated operator system.

An automated operator system can handle the call if the call type supports automation and an applicable system is available. The following automated operator systems are used:

- Automated Alternate Billing Service (AABS)
- Automatic Coin Toll Service (ACTS)
- Automated Directory Assistance Service (ADAS)
- Mechanized Calling Card Service (MCCS)

## **BRANDOPT** (continued)

---

The determination of whether a call should be branded is made by table BRANDOPT and office parameters TOPS\_BRAND\_OFFICE and TOPS\_BRAND\_INWARDS in table OFCENG.

### **Branding determination by office parameter TOPS\_BRAND\_OFFICE**

Office parameter TOPS\_BRAND\_OFFICE determines, on an office-wide basis, which operator systems (OPERATOR, AABS, ACTS, ADAS, or MCCS) receive branding announcements for calls arriving on supported trunk groups. Branding can be enabled for all calls destined for a particular operator system by including that system in office parameter TOPS\_BRAND\_OFFICE.

For example, to turn on branding for all ACTS calls arriving on any supported trunk group, include ACTS in office parameter TOPS\_BRAND\_OFFICE.

Branding does not apply to all types of calls or trunk groups. Refer to the restrictions information later in this section for details.

Call branding can also be enabled on a trunk group basis. Table BRANDOPT can be used to enable branding of calls destined for a particular operator system but arriving on specified trunk groups only. Each tuple in table BRANDOPT contains a trunk group common language location identifier (CLLI) and a set of operator system types for which branding is in effect. The table is accessed only if office parameter TOPS\_BRAND\_OFFICE does not include the operator system for which the call is destined.

If office parameter TOPS\_BRAND\_OFFICE does not include the operator system for which the call is destined and the incoming trunk group CLLI is not datafilled in table BRANDOPT, then the call is not branded.

If office parameter TOPS\_BRAND\_OFFICE does not include the operator system for which the call is destined but the incoming trunk group CLLI is datafilled in table BRANDOPT, then table BRANDOPT specifies whether or not the call is branded.

If branding is not in effect for a particular automated operator system on the incoming trunk group but is in effect for operator calls, and the call is transferred from the automated system to an operator, then a branding announcement (although not played prior to the call being handled by the automated system) is played before connecting the user to an operator.

### **Branding determination by office parameter TOPS\_BRAND\_INWARDS**

Inwards calls are calls received from distant operators who dial a special routing code to reach an operator in this operator service office. The special routing codes, datafilled in table TOPS, are 121, 131, 141, 151, 161, 171, 181, 191, 1151, 1152, 1153, 1154, 1155, 1156, 1157, 1158, 1159, 1160, 1161, and

---

**BRANDOPT** (continued)

---

1162. Most requests from distant operators are to assist a calling party in their operator service office control area to reach a called party in this operator service office control area.

Branding on inwards calls is enabled by office parameter TOPS\_BRAND\_INWARDS. If TOPS\_BRAND\_INWARDS is set to Y (yes), a branding announcement is played before connecting to an operator. The company name branded is always the name of the operating company providing the operator services. If TOPS\_BRAND\_INWARDS is set to N (no), a branding announcement is not played before connecting to an operator.

**Announcement selection**

To brand the call with a customized announcement, the CLLI of the appropriate announcement is required. Announcements are identified by a phrase name chosen at recording time. A CLLI is associated with the phrase name by datafill in table DRAMTRK. This CLLI is obtained from table BRANDANN. Table BRANDANN is indexed by code 0000 (reserved for the operating company that provides the operator services), the carrier access code (CAC) if the call involves an inter-local access and transport area (LATA) carrier, or a non-Bell exchange company (NBEC) code.

For a non-carrier call arriving on a TOPS-type trunk group, table BRANDOPT indicates whether to look in table NBECCODE for the company code or to use the default code datafilled in table TRKGRP. If the call arrives as automatic number identification (ANI) fail or operator number identification (ONI) call, the trunk group default code is used. The default code applies to TOPS trunk group types only.

The announcement CLLI datafilled in table BRANDANN is used to access table DRAMTRK and select the applicable announcement phrase to play to the subscriber. Two announcement CLLIs can be datafilled for each company: one for DA calls and one for TA calls.

**ANI-fail and ONI calls**

For calls arriving on TOPS-type trunk groups, the calling number can be used to determine the NBEC, but for ANI-fail or ONI calls, the calling number is not available. As a result, table NBECCODE cannot be accessed for intra-LATA calls since the key to the table consists of a calling number. Instead, a default company code is provided in field NBECCODE of table TRKGRP for TOPS-type trunk groups.

If a call arrives on an access tandem-to-carrier (ATC) trunk, the carrier code datafilled in table TRKGRP is used for branding.

## **BRANDOPT** (continued)

---

If the call arrives on an inter-toll (IT) trunk, the operating company code of 0000 is used to index table BRANDANN and the announcement associated with this code is played to the calling party.

### **Restrictions**

Branding announcements are provided for calls arriving on trunk groups of group types ATC, IT, or TOPS only.

Branding of operator calls does not apply to remote operator number identification (RONI) and centralized automatic message accounting (CAMA) calls, intercept, recalls, or operator transfers. It also does not apply to calls over direct lines to TOPS.

Calls arriving on an IT trunk can be branded with operating company announcements only. A carrier code is not signaled or datafilled for IT trunks, and since ANI digits are not received on IT trunks, neither the carrier nor the NBEC can be determined.

Recalls from a coin phone, time and charges, and sequence calls for MCCS are not branded.

Flash supervision is not provided during the playing of an announcement. The user must wait to be connected to an operator, or flash hook after being connected to an automated operator system to reach an operator.

It is recommended that all announcements in an office be recorded in the same voice.

### **Functional description**

Table BRANDOPT is indexed by an incoming trunk group CLLI. For each incoming trunk group CLLI datafilled, table BRANDOPT specifies the operator system or systems for which branding is in effect, and whether table NBECCODE should be used to obtain the company code for the call.

Office parameter TOPS\_BRAND\_OFFICE in table OFCENG takes precedence over table BRANDOPT. An operator system type datafilled in field OPERSYS in table BRANDOPT has an effect only if office parameter TOPS\_BRAND\_OFFICE does not include that operator system. Thus table BRANDOPT can add, but not delete, branding on a trunk group basis.

For example, if TOPS\_BRAND\_OFFICE includes only the operator system OPERATOR, then branding for mechanized calling card service (MCCS) calls can be added for a particular trunk group by adding the trunk group CLLI (for example, ICTOPS) to table BRANDOPT and datafilling MCCS against it in

---

**BRANDOPT** (continued)

---

field OPERSYS. However, if TOPS\_BRAND\_OFFICE includes both OPERATOR and MCCS and trunk group ICTOPS is datafilled in table BRANDOPT with only OPERATOR, calls arriving over trunk group ICTOPS destined for MCCS are still branded.

Trunk groups of group types TOPS, inter-toll (IT), or access tandem-to-carrier (ATC) can be datafilled in table BRANDOPT. The following error message appears if an attempt is made to datafill a trunk group that is not a TOPS, IT, or ATC trunk:

```
SHOULD BE A TOPS/IT/ATC TRUNK CLLI
```

Field NBECLOOK specifies whether or not to look in table NBECCODE to obtain the company code for the call. This enables traffic from different companies to be tandemed to the TOPS switch. This also enables the operating company to partition its traffic, if necessary, for provisioning of announcements. Field NBECLOOK is applicable to TOPS trunks only.

No default datafill is required for table BRANDOPT; the table can remain empty until datafilled by the operating company.

### **Datafill sequence and implications**

The following tables must be datafilled after table BRANDOPT.

- CLLI
- TRKGRP

### **Table size**

0 to 8191 tuples

**BRANDOPT** (continued)**Datafill**

The following table lists datafill for table BRANDOPT.

**Field descriptions**

Field	Subfield or refinement	Entry	Explanation and action
ICTRKGRP		alphanumeric (1 to 16 characters)	Incoming trunk group CLLI. Enter the code assigned to the incoming trunk group in table CLLI. The trunk group type must be TOPS, inter-toll (IT), or access tandem-to-carrier (ATC).
OPERSYS		AABS ACTS ADAS MCCS OPERATOR ALL or NONE	<p>Operator Systems. Specify the set of operator systems to which branding applies. Enter one or more of the following systems, with each separated by at least one blank.</p> <ul style="list-style-type: none"> <li>• AABS - call is handled by the Automated Alternate Billing Service</li> <li>• ACTS - call is from a coin phone and the charges and coin calculations are handled by the Automatic Coin Toll Service</li> <li>• ADAS - call is handled by the Automated Directory Assistance Service</li> <li>• MCCS - call is handled by the Mechanized Calling Card Service</li> <li>• OPERATOR - call is destined for an operator or placed in a queue pending an available operator</li> <li>• ALL - all of the above operator systems are used (full set)</li> <li>• NONE - none of the above operator systems are used (empty set)</li> </ul>
NBECLOOK		Y or N	<p>Non-Bell company code look. Enter Y (yes), if the system is to use table NBECCODE to obtain the non-Bell company code based upon the calling number. Enter N (no), if the system is to use the default code datafilled in table TRKGRP.</p> <p><b>Note:</b> This field is used for TOPS-type trunks only.</p>



**Datafill example**

The following example shows sample datafill for table BRANDOPT.

**MAP display example for table BRANDOPT**

ICTRKGRP	OPERSYS	NBECLOOK
ICTOPTRK	OPERATOR MCCS ACTS	Y
TOPSICITTRK	MCCS ACTS	Y
TOPSTKIC	OPERATOR AABS	N

---

## C6LAYER

---

### Table name

The CCIS6 Layer Allocation Table

### Functional description

This table provides data assignment for the transfer of signaling messages across the interface. These messages transfer between the message transfer part of the message switch buffer (MSB) and the user part in the central control (CC).

Table C6LAYER assigns the signaling link that transmits and receives signaling messages for a specified layer over the common channel interoffice signaling (CCIS) network.

Table C6LAYER stores the following data:

- The layer number associated with a newly created layer. An office can send signals over a maximum of 30 layers.
- The band count associated with the number of equipped internal bands for each layer, for a specified office.
- The common language location identifier (CLLI) name for a signaling link. Table C6LKSET must specify this name.

### Datafill sequence and meaning

You must enter data in table C6LKSET before you enter data in table C6LAYER.

### Datafill

Datafill for table C6LAYER appears in the following table.

#### Field descriptions (Sheet 1 of 2)

Field	Subfield or refinement	Entry	Explanation and action
LAYERNO		see subfield	<i>Layer number.</i> This field contains subfield LAYER_NO. This field is the key to the table.
	LAYER_NO	0 to 29	<i>Layer number.</i> Enter the number specified for a newly defined layer.
BANDCNT		1 to 254	<i>Band count.</i> Enter the number of internal bands in a layer.

**C6LAYER** (end)**Field descriptions (Sheet 2 of 2)**

Field	Subfield or refinement	Entry	Explanation and action
LINKSETS		see subfield	<i>Link sets.</i> This field contains subfield CLLI. You can enter a maximum of two link sets. If less than two link sets are required, end the list with a \$.
	CLLI	alphanumeric (1 to 16 characters)	<i>Signaling link zero.</i> Enter a maximum of two CLLI defined in table C6LKSET, field LINKNAME. One CLLI for the even and one CLLI for the odd circuits are assigned to the layer.

**Datafill example**

Datafill for table C6LAYER appears in the following example.

**MAP example for table C6LAYER**

LAYERNO	BANDCNT	LINKSETS
0	4	LINK00 LINK01

**Table history**  
**BCS36**

Subfield LAYER\_NO was added in BCS36. Refinement CLLI replaced LINKSET0 and LINKSET1.

## C6LKSET

---

### Table name

Common Channel Interoffice Signaling No. 6 (CCIS6) Link Table

### Functional description

Table C6LKSET stores the duplicate signaling links information. Table C6LKSET contains the following data assignment for each signaling link:

- the common language location identifier (CLLI). Table CLLI must specify CLLI.
- if the signaling link is A (access), B (bridge), C (cross), D (diagonal), E (external), F (fully associated), or I (interprocessor)
- if the link is a Common Channel Interoffice Signaling No. 6 (CCIS6) or an Embedded Common Channel Interoffice Signaling (ECIS) type
- signaling terminal slot number. Table STINV specifies the signaling terminal slot number.
- the voice frequency link identifier that table TRKMEM must specify

### Datafill sequence and meaning

You must enter data in the following tables before you enter data in table C6LKSET:

- CLLI
- TRKMEM
- STINV

### Table size

0 to 60 tuples

**C6LKSET** (continued)**Datafill**

Datafill for table C6LKSET appears in the following table.

**Field descriptions (Sheet 1 of 2)**

Field	Subfield or refinement	Entry	Explanation and action
LINKNAME		alphanumeric (1 to 16 characters)	<i>Link name.</i> Enter the CLLI table CLLI defined for the link. The system supports a maximum of 60 signaling links.
NETTYPE		A to E	<i>Network type.</i> Enter the CCIS6 network link type, A (access) or E (external).  Any entry outside the range indicated for this field is not correct.
LINKINFO		see subfields	<i>Link information.</i> This field contains subfields SIG, STNO, VFLO and VFL1.
	SIG	C 6	<i>Signal.</i> Enter the signaling type C6.  Any entry out of the range indicated for this field is not correct.
	STNO	0 to 63	<i>External signaling terminal number.</i> Enter the external signaling terminal index number (predefined in table STINV).
	VFLO	see subfields	<i>Voice frequency link zero.</i> This subfield contains subfields CLLI and EXTRKNM.
	CLLI	alphanumeric (1 to 16 characters)	<i>Common language location identifier.</i> Enter the CLLI assigned in table TRKMEM to the trunk group that the even trunk circuit is a member.
	EXTRKNM	0 to 9999	<i>External trunk number.</i> Enter the external trunk number assigned to the even trunk circuit.
	VFL1	see subfields	<i>Voice frequency link on.</i> This subfield contains subfields CLLI and EXTRKNM.

**C6LKSET** (end)

**Field descriptions (Sheet 2 of 2)**

Field	Subfield or refinement	Entry	Explanation and action
	CLLI	alphanumeric (1 to 16 characters)	<i>Common language location identifier.</i> Enter the CLLI assigned in table TRKMEM to the trunk group of which the odd trunk circuit is a member.
	EXTRKNM	0 to 9999	<i>External trunk number.</i> Enter the external trunk number assigned to the odd trunk circuit.

**Datafill example**

Datafill for table C6LKSET appears in the following example.

**MAP example for table C6LKSET**

LINKNAME	NETTYPE	LINKINFO
LINK00	A C6 0	VFL000 0 VFL001 0

**Table history**  
**BCS36**

The table size was added in BCS36.

---

**C6TRKMEM**

---

**Table name**

The CCIS6 Trunk Member Table

**Functional description**

This table relates the CCIS trunks that table TRKMEM defines to the signaling network identifiers (SNID) of the CCIS trunks. Each SNID contains a layer number, band number, and circuit number.

A maximum of 30 layers is present over which every office can signal. Each layer can contain a maximum of 512 bands. Each band can contain a maximum of 16 circuits.

A one-to-one communication must be present between the following:

- each CCIS trunk of intertoll type
- in an office
- one of the 16 circuits which are signaling channel slots in a band of a given layer in the CCIS network

Entries in table C6TRKMEM are accessed in parallel with table TRKMEM by CLI and external trunk number.

The maximum number of trunks for each layer is 2000.

**Datafill sequence and meaning**

You do not need to enter data in other tables before you enter data in table C6TRKMEM.

**Table size**

0 to 8191 tuples

The entry for table TRKGRP in table DATASIZE controls the size of table C6TRKMEM.

## C6TRKMEM (end)

### Datafill

Datafill for table C6TRKMEM appears in the following table.

#### Field descriptions

Field	Subfield or refinement	Entry	Explanation and action
MEMKEY		see subfields	<i>Member key.</i> This field contains subfields CLLI and MEMNAME.
	CLLI	alphanumeric (1 to 16 characters)	<i>Common language location identifier.</i> Enter the code assigned in table CLLI to the intertoll CCIS trunk group of which the trunk is a member.
	MEMNAME	numeric (0 to 9999)	<i>External trunk number.</i> Enter the external trunk number assigned to the CCIS trunk.
LAYER		numeric (0 to 29)	<i>Layer.</i> Enter the layer number in the office. Entries out of the range 0 to 29 are not correct.
BAND		numeric (0 to 511)	<i>Band.</i> Enter the band number in the office.
CKT		numeric (0 to 15)	<i>Circuit.</i> Enter the circuit number in the band.

### Datafill example

Datafill for table C6TRKMEM appears in the following example. The assignments for one trunk member known appear in this example. The CLLI code for this trunk member is CCIS404A.

#### MAP example for table C6TRKMEM

MEMKEY	LAYER	BAND	CKT
CCIS404A	0	0	2 1



---

**C7AFTPC**

---

**Table name**

CCS7 Gateway STP SCCP Management Affected Point Code Screening Table

**Functional description**

Table C7AFTPC screens messages in American National Standards Institute (ANSI) and NTC7 format. It defines the gateway screening functions for the signaling connection control part (SCCP) management (SCMG) affected point code.

*Note:* All references to signaling transfer point (STP) are applicable to the STP/Service Switching Point (SSP) Integrated Nodes (INode), unless otherwise specified.

For related information, refer to table C7GTWLKS.

**Datafill sequence and implications**

The following table must be datafilled after table C7AFTPC.

- C7CDPA

**Table size**

Up to 32 767 tuples

Up to 2000 tuples in INode

The limit of 2000 tuples for this table depends on the datafill in the other gateway screening tables.

The limit of 32 767 tuples for this table depends on the datafill in the other gateway screening tables and has the following restrictions:

- up to 1024 screening references for all tables
- up to 256 rules for each screening reference

**C7AFTPC** (continued)**Datafill**

The following table lists datafill for table C7AFTPC.

**Field descriptions (Sheet 1 of 2)**

Field	Subfield or refinement	Entry	Explanation and action
SCRNREF		see subfields	<i>Screening reference.</i> This field consists of subfields REFERNCE and RULENO.
	REFERNCE	alphanumeric (1 to 4 characters)	<i>Screening reference.</i> Enter a value that identifies a signaling connection control part (SCCP) management (SCMG) affected point code screening function.
	RULENO	0 to 255	<i>Rule number.</i> Enter a number to identify a rule within a screening function. Each screening function can consist of up to 256 distinct rules.
SCRNRULE		see subfields	<i>Screening rule.</i> This field contains all of the screening rule information and consists of subfields NETTYPE, FROMPC, TOPC, FROMSSN, and TOSSN.
	NETTYPE	ANSI7 or NTC7	<i>Network type.</i> Enter ANSI7 if the screened point codes are in ANSI format. This table is not used for screening messages in the CCITT format.  Enter NTC7 if the point codes being screened are in the NTC7 format.
	FROMPC	a vector from 0 to 3 values in the range 0 to 255	<i>From point codes.</i> If the NETTYPE is ANSI7, enter a full or partial point code (PC) representing the start of the range of SCMG affected point codes to which this rule applies. Up to three values can be datafilled. If less than three values are required, end the list with a \$.  <b>Note:</b> For NTC7 network types, only a full PC is valid. The \$ (dollar sign) symbol is not accepted.  The value of subfield FROMPC must be less than or equal to the value of subfield TOPC.

**C7AFTPC** (continued)

## Field descriptions (Sheet 2 of 2)

Field	Subfield or refinement	Entry	Explanation and action
	TOPC	a vector from 0 to 3 values in the range 0 to 255	<p><i>To point codes.</i> Enter a full or partial PC representing the end of the range of SCMG-affected point codes to which this rule applies. End the vector with a blank space and a \$.</p> <p><b>Note:</b> For NTC7 network types, only a full PC is valid. The \$ symbol is not accepted.</p> <p>The value of subfield TOPC must be greater than or equal to the value of subfield FROMPC.</p>
	FROMSSN	0 to 255or \$	<p><i>From subsystem number.</i> Enter the first subsystem number in the range of subsystem numbers to which this rule applies.</p> <p>The value in subfield FROMSSN must be less than the value in subfield TOSSN.</p> <p>If the rule includes all subsystem numbers, enter \$ (no subsystem numbers specified).</p>
	TOSSN	0 to 255or \$	<p><i>To subsystem number.</i> Enter the last subsystem number in the range of subsystem numbers to which this rule applies.</p> <p>The value in subfield TOSSN must be greater than the value in subfield FROMSSN.</p> <p>If the rule includes all subsystem numbers, enter \$ (no subsystem numbers specified).</p>
REMARKS		alphanumeric (1 to 8 characters)	<p><i>Remarks.</i> This field is specified by the operating company and can be used to identify the name of the network or carrier to which the link is connected. Any eight-character value can be stored in this field. Avoid the use of special characters, such as +, *, /, -, and %.</p>
OPTIONS		see subfields	<p><i>Options.</i> This field consists of subfield OPTNAME.</p>
	OPTNAME	\$	<p><i>Option name.</i> Enter \$, which is the only valid entry.</p>

**C7AFTPC** (continued)

**Datafill example**

The following example shows sample datafill for table C7AFTPC.

The example consists of screening for affected point codes. This screening is performed only if the called party address of the message is 1 and the service indicator of the message is 3.

If the message being screened matches the rule, the screening is finished and the call is routed normally.

No screening options are required, so \$ is entered in subfield OPTNAME.

**MAP display example for table C7AFTPC**

SCRNREF	OPTIONS	SCRNRULE	REMARKS
REF9	1 ANSI7 ( 1) ( 1) ( 4)\$ ( 1) ( 1) ( 5)\$ (251)\$ (251)\$		\$
	\$		
REF9	2 ANSI7 ( 1) ( 1) ( 8)\$ ( 1) ( 1) ( 10)\$ (251)\$ (251)\$		\$
	\$		
REF9	3 ANSI7 ( 1) ( 1) ( 18)\$ ( 1) ( 1) ( 20)\$ (251)\$ (251)\$		\$
	\$		
REF9	4 ANSI7 ( 1) ( 1) ( 23)\$ ( 1) ( 1) ( 28)\$ (251)\$ (251)\$		\$
	\$		
REF9	5 ANSI7 ( 1) ( 1) ( 29)\$ ( 1) ( 1) ( 30)\$ (251)\$ (251)\$		\$
	\$		

**Table history**

**STP04.0**

Removed references to MDR7 screening.

**CSP06**

Removed information about bulk deletion workaround.

---

**C7AFTPC** (end)

---

**CSP02**

Added information about the possibility of service degradation if gateway screening is not turned off.

**BCS36**

Added information about bulk deletions.

**Supplementary information**

This section provides information on modifying datafill in table C7AFTPC.

**Datafill modifications****DANGER****Risk of service degradation**

A service degradation can occur if gateway screening is not turned off in table C7GTWLKS prior to making additions, deletions, or changes to table C7AFTPC.

The table control warning is displayed at the MAP display if a user attempts to add, change, or delete tuples in table C7AFTPC.

A similar message is displayed in all the gateway screening tables (C7AFTPC, C7ALWDPC, C7ALWGTT, C7ALWOPC, C7ALWSIO, C7BLKDPC, C7BLKOPC, C7BLKSIO for CCITT only, C7CDPA, C7CGPA, and C7DSTFLD).

*Note:* The VERIFY function must be turned on. If VERIFY is off, the above warning is not displayed.

## C7ALIAS

---

### Table name

CCS7 Capability Codes Table

### Functional description

Table C7ALIAS allows a Common Channel Signaling 7 (CCS7) signal transfer point (STP) to identify itself by more than one point code. This table contains the additional point codes, called capability codes, that can be used to address the STP. The originating point code (OPC) is not datafilled in this table, since this point code is already datafilled in table C7NETWRK.

If this table is not datafilled, it has no effect on the operation of the STPs.

A node in a CCS7 network can only accept messages destined for it by comparing the destination point code in the message against the single point code that is the network address of the node.

Table C7ALIAS allows the node to accept messages that are destined for its point code and also those messages that are destined for a capability code. A capability code is fully specified by a network name, as datafilled in table C7NETWRK, the network type, and a vector of three integers. These three integers have different ranges depending on the network type that is entered.

A point code that is used as a capability code cannot be used as a network identifier as defined in table C7NETWRK, or as a routing destination as defined in table C7RTESET.

New tuples can be added to table C7ALIAS only if the node type that is datafilled in table C7NETWRK contains a subset of STP for the given network.

### Datafill sequence and implications

Table C7NETWRK must be datafilled before table C7ALIAS.

If STP SOC is present, table C7ALIAS is visible on an SSP. The table can be datafilled whether STP SOC is ON or IDLE, but functionality is only available when STP SOC is set to ON.

### Table size

0 to 1024 tuples

Maximum table size is fixed at 256 alias tuples for each network tuple.

**C7ALIAS** (continued)**Datafill**

The following table lists datafill for table C7ALIAS.

**Field descriptions**

Field	Subfield or refinement	Entry	Explanation and action
ALIAS		see subfields	<i>Alias</i> This field contains the additional point codes, called capability codes, that can be used to address the STP, in addition to the originating point code that is datafilled in table C7NETWRK. This field consists of subfields NETNAME and PTCODE.
	NETNAME	alphanumeric (1 to 16 characters)	<i>Network name</i> Enter the network name, previously datafilled in table C7NETWRK, to identify the network to which this capability code belongs.
	PTCODE	see subfield	<i>Capability point code</i> This field consists of subfield NETTYPE.
	NETTYPE	ANSI7, CCITT7, NTC7, JPN7, or TTC7	<i>Network type</i> Enter the network type and datafill the subfields of refinement NETTYPE.  If the network type is North American, enter ANSI7 and datafill subfields NETWORK, CLUSTER, and MEMBER, which make up the far-end point code.  If the network type is international, enter CCITT7 and datafill refinement FORMAT and its refinements.  If the network type is telecommunication technology committee signaling system 7 (TTC7), used in Japan on the DMS-250, enter TTC7 and datafill refinements MAINAREA, SUBAREA, and AREAUNIT, which make up the far-end point code.

**C7ALIAS** (continued)

---

**NETTYPE=ANSI7**

If the entry in subfield NETTYPE is ANSI7, datafill the refinements NETWORK, CLUSTER and MEMBER.

**Field descriptions for conditional datafill**

<b>Field</b>	<b>Subfield or refinement</b>	<b>Entry</b>	<b>Explanation and action</b>
	NETWORK	0 to 255	<i>Network identifier</i> Enter the number of the network identifier that is assigned to the far-end switching unit of the specified network.
	CLUSTER	0 to 255	<i>Cluster identifier</i> Enter the number of the network identifier cluster that is assigned to the far-end switching unit of the specified network.
	MEMBER	0 to 255	<i>Member</i> Enter the number of the cluster member that is assigned to the far-end switching unit of the specified network.



**C7ALIAS** (continued)**NETTYPE=CCITT7**

If the entry in subfield NETTYPE is CCITT7, datafill the subfields FORMAT, and its refinements.

**Field descriptions for conditional datafill (Sheet 1 of 3)**

Field	Subfield or refinement	Entry	Explanation and action
	FORMAT	AUSTRIA BASIC INTL CHINA orGERMAN	<p><i>CCITT format</i></p> <p>This field specifies the CCITT7 point code refinements that are required for the network.</p> <p>If the point code used is for Austria, enter AUSTRIA and datafill refinements ZONE, REGION, and SIGPOINT.</p> <p>If the point code used is based on one field, enter BASIC and datafill refinement PC.</p> <p>If the point code used is for China, enter CHINA and datafill refinements ZONE, EXCHANGE, and SIGPOINT.</p> <p>If the point code used is international, enter INTL and datafill refinements ZONE, AREANETW, and SIGPOINT.</p> <p>If the point code is for Germany, enter GERMAN and datafill refinements NUMAREA, HVST, KVST and SIGPOINT.</p>
	ZONE	0 to 31	<p><i>Zone identifier</i></p> <p>Enter the zone identifier that is assigned to the far-end switching unit for the specified network.</p> <p>If the entry in subfield FORMAT is AUSTRIA, the range is 0 to 31.</p> <p>If entry in field FORMAT is CHINA, the range is 0 to 15.</p> <p>If the entry in field FORMAT is INTL, the range is 0 to 7.</p>
	PC	0 to 16383	<p><i>Point code</i></p> <p>If the entry in subfield FORMAT is BASIC, enter the number of the FEPC that has been assigned to the far-end switching unit for the specified network.</p>

**C7ALIAS** (continued)**Field descriptions for conditional datafill (Sheet 2 of 3)**

<b>Field</b>	<b>Subfield or refinement</b>	<b>Entry</b>	<b>Explanation and action</b>
	REGION	0 to 15	<i>Region</i> If the entry in subfield FORMAT is AUSTRIA, enter the number of the region that has been assigned to the far-end switching unit for the specified network.
	EXCHANGE	0 to 127	<i>Exchange</i> If the entry in subfield FORMAT is CHINA, enter the number of the exchange in the zone that has been assigned to the far-end switching unit for the specified network.
	AREANETW	0 to 255	<i>Area/network identifier</i> If the entry in subfield FORMAT is INTL, enter the number of the area/network identifier in the zone that has been assigned to the far-end switching unit for the specified network.
	NUMAREA	0 to 15	<i>Numbering Area</i> If the entry in subfield FORMAT is GERMAN, enter the area number assigned to the office.
	HVST	0 to 7	<i>HVSt</i> If the entry in subfield FORMAT is GERMAN, enter the HVSt number assigned to the office.

**C7ALIAS** (continued)**Field descriptions for conditional datafill (Sheet 3 of 3)**

<b>Field</b>	<b>Subfield or refinement</b>	<b>Entry</b>	<b>Explanation and action</b>
	KVST	0 to 15	<i>KVSt</i> If the entry in subfield FORMAT is GERMAN, enter the KVSt number assigned to the office.
	SIGPOINT	0 to 31	<i>Signal point identifier</i> If the entry in subfield FORMAT is AUSTRIA, enter the number of the signal point in the region that has been assigned to the far-end switching unit for the specified network. The range is 0 to 31.  If the entry in subfield FORMAT is CHINA, enter the number of the signal point in the exchange that has been assigned to the far-end switching unit for the specified network. The range is 0 to 7.  If the entry in subfield FORMAT is GERMAN, enter the number of the signal point in the exchange that has been assigned to the far-end switching unit for the specified network. The range is 0 to 7.

**C7ALIAS** (continued)**NETTYPE=TTC7**

If the entry in subfield NETTYPE is TTC7, datafill the subfields MAINAREA, SUBARREA, and AREAUNIT.

**Field descriptions for conditional datafill**

Field	Subfield or refinement	Entry	Explanation and action
	MAINAREA	0 to 31	<i>Main area</i> If the entry in subfield NETTYPE is TTC7, enter the number of the main area. This is the first part of the capability code for the TTC7 signaling used in Japan on the DMS-250 switch.
	SUBAREA	0 to 15	<i>Subarea</i> Enter the number of the subarea of the main area that has been assigned to the far-end switching unit for the specified network. This is the second part of the capability code for the TTC7 signaling used in Japan on the DMS-250 switch.
	AREAUNIT	0 to 127	<i>Area unit</i> Enter the number of the area unit in the sub-area that has been assigned to the far-end switching unit for the specified network. This is the third part of the capability code for the TTC7 signaling used in Japan on the DMS-250 switch.

**Datafill example**

The following example shows sample datafill for table C7ALIAS.

The example consists of two capability codes for a North American network, C7NETWRK1.

**C7ALIAS** (continued)**MAP display example for table C7ALIAS**

ALIAS				
C7NETWRK1	ANS17	1	0	255
C7NETWRK1	ANS17	2	2	63

**Table history****TL08**

Added STP SOC note.

**TL06**

Error messages were updated to require STP capability in table C7NETWRK.

**Supplementary information**

This section provides information on datafilling table C7ALIAS for specific applications, and product descriptive information related to table C7ALIAS.

**Error messages**

If the name entered in subfield NETTYPE does not match the network name that is entered in table NETTYPE, then the following error message is displayed.

NETTYPE does not match the C7NETWRK table entry.

If a capability code with the same point code as the network originating point code is entered, then the following error message is displayed.

Point Code is already in the C7NETWRK table.

If a capability code with the same point code as a routeset destination point code is entered, then the following error message is displayed.

Point Code is already in the C7RTESET table.

If any of the above error messages occur, compare the data being entered with the data that is stored in tables C7NETWRK and C7RTESET. Correct the data for the capability code that is being entered in table C7ALIAS.

## **C7ALIAS (end)**

---

If the operating company enters a NETNAME that is not datafilled in the C7NETWRK table, then the following error message is displayed.

```
NETWORK not datafilled.
```

If the operating company tries to use the change command, the following error message is displayed.

```
NO fields of the C7ALIAS table are modifiable.
```

If the node type datafilled in table C7NETWRK does not contain STP capability, then tuples cannot be datafilled in table C7ALIAS. If the node type datafilled in table C7NETWRK does not contain STP capability, the following error message is displayed.

```
Invalid operation for node type.
```

### **Display of table C7ALIAS using the list command**

When using the table editor list command, the entries in table C7ALIAS are not displayed in the same order in which they are entered. Instead, they are sorted. All capability codes that are associated with the same network are grouped together. These groups are displayed based on the order of the network within table C7NETWRK. The point codes within each group are sorted by least significant field first. With an ANSI7 point code the member field is sorted first, then the cluster, then the network field. The ordering is described in the following table.

#### **Network order within table C7NETWRK**

<b>Entered in this order</b>	<b>Displayed in this order</b>
NETWORK ANSI7 1 1 64	NETWORK1 ANSI7 5 5 62
NETWORK ANSI7 1 2 64	NETWORK1 ANSI7 2 2 63
NETWORK ANSI7 2 1 64	NETWORK1ANSI7 1 1 64
NETWORK ANSI7 2 2 63	NETWORK1ANSI7 2 1 64
NETWORK ANSI7 5 5 62	NETWORK1ANSI7 1 2 64

---

**C7ALWDPC**

---

**Table name**

CCS7 Gateway STP Allowed Destination Point Codes Screening Table

**Functional description**

Table C7ALWDPC specifies screening functions for allowed destination point codes (DPC). Each screening function consists of a set of one or more screening rules. Each screening rule can have a different screening result.

*Note:* All references to signaling transfer point (STP) are applicable to the STP/Service Switching Point (SSP) Integrated Nodes (INode), unless otherwise specified.

For related information, refer to table C7GTWLKS.

**Datafill sequence and implications**

The following tables (if required) must be datafilled prior to table C7ALWDPC:

- C7BLKDPC
- C7CGPA
- C7DSTFLD

The following tables (if required) must be datafilled after table C7ALWDPC:

- C7ALWOPC
- C7ALWSIO
- C7BLKSIO (for network type CCITT7 only)
- C7BLKOPC
- C7GTWLKS

**Table size**

32 767 tuples

Up to 2000 tuples

**Table size restrictions**

The limit of 2000 tuples for this table depends on the datafill in the other gateway screening tables. There are a maximum of 2000 possible screening rules for all of the gateway tables (except table C7GTWLKS).

**C7ALWDPC** (continued)

- The limit of 32 767 tuples for this table depends on the datafill in the other gateway screening tables. There are a maximum of 32 767 possible screening rules for all of the gateway tables (except table C7GTWLKS) so the maximum number of tuples for the tables is 32 767 with the following restrictions:
- up to 1024 screening references for all tables
- up to 256 rules for each screening reference

**Datafill**

The following table lists datafill for table C7ALWDPC.

**Field descriptions (Sheet 1 of 5)**

Field	Subfield or refinement	Entry	Explanation and action
SCRNREF		see subfields	<i>Screening reference</i> This field is the key to the table and consists of subfields REFERENCE and RULENO.
	REFERENCE	alphanumeric (1 to 4 characters)	<i>Screening reference</i> Enter a value that uniquely identifies an allowed destination point code (DPC) screening function. This is the first part of a two-part key.
	RULENO	0 to 255	<i>Rule number</i> Enter a number to identify a rule in a screening function. Each screening function can consist of up to 256 distinct rules. This is the second part of a two-part key.
SCRNRULE		see subfields	<i>Screening rule</i> This field contains all of the screening rule information and consists of subfields NETTYPE, FROMPC, TOPC, PCRANGE and RESULT.
	NETTYPE	ANSI7, CCITT7, or NTC7	<i>Network type</i> Enter the network type of the screening rule.  If the network type is ANSI7, the point codes being screened are in American National Standards Institute (ANSI) format. All screening functions defined prior to the BCS30 release of this table are ANSI7 format. Datafill refinements FROMPC, TOPC, and RESULT.



**C7ALWDPC** (continued)

## Field descriptions (Sheet 2 of 5)

Field	Subfield or refinement	Entry	Explanation and action
			<p>If the network type is CCITT7, the screened point codes are in the CCITT format. Datafill refinements PCRANGE and RESULT.</p> <p>If the network type is NTC7, the screened point codes are in the NTC7 format. Datafill refinements FROMPC, TOPC, and RESULT.</p> <p>Each rule of screening function must be of the same network type. The network type of a screening function cannot be changed.</p>
	PCRANGE	see subfields	<i>CCITT point code range</i> If NETTYPE is CCITT7, datafill this refinement. It consists of subfields FORMAT, FROMPC and TOPC.
	FORMAT	INTL or BASIC	<i>Format of CCITT point codes</i> If entry in field NETTYPE is CCITT7, and the CCITT format required is international, enter INTL. If the format required is not international, enter BASIC.
	FROMPC	numeric	<i>From point code</i> If the entry in NETTYPE is CCITT7 and the entry in field FORMAT is INTL, enter a full DPC representing the start of the range of DPCs for this rule. This is specified as a multiple consisting of FROMZONE with a range of values from 0 to 7, FROMAREA with a range of values from 0 to 255 and FRMPPOINT with a range of values from 0 to 7.

**C7ALWDPC** (continued)

## Field descriptions (Sheet 3 of 5)

Field	Subfield or refinement	Entry	Explanation and action
	TOPC	numeric	<p>If the entry in NETTYPE is CCITT7 and the entry in field FORMAT is BASIC, enter a full DPC representing the start of the range of DPCs for this rule. The range of values that can be entered is from 0 to 16383.</p> <p>If the entry in NETTYPE is ANSI7, enter a full or partial DPC representing the start of the range of DPCs for this rule. This is specified as a vector of zero to three values in the range 0 to 255. End the vector with a blank column and a \$ (dollar sign).</p> <p>If the entry in NETTYPE is NTC7, enter a full DPC representing the start of the range of DPCs for this rule. The \$ (dollar sign) is not allowed.</p> <p>The value of subfield FROMPC must be less than or equal to the value in subfield TOPC.</p> <p><i>To point codelf</i> the entry in NETTYPE is CCITT7 and the entry in field FORMAT is INTL, enter a full DPC representing the end of the range of DPCs for this rule. This is specified as a multiple consisting of TOZONE with a range of values from 0 to 7, TOAREA with a range of values from 0 to 255, and TOPOINT with a range of values from 0 to 7.</p> <p>If the entry in NETTYPE is CCITT7 and the entry in field FORMAT is BASIC, enter a full DPC representing the end of the range of DPCs for this rule. The range of values that can be entered is from 0 to 16 383.</p>

**C7ALWDPC** (continued)

## Field descriptions (Sheet 4 of 5)

Field	Subfield or refinement	Entry	Explanation and action
			<p>If the entry in NETTYPE is ANSI7, enter a full or partial DPC representing the end of the range of DPCs for this rule. This is specified as a vector of zero to three values in the range 0 to 255. End the vector with a blank column and a \$.</p> <p>If the entry in NETTYPE is NTC7, enter a full DPC representing the end of the range of DPCs for this rule. The \$ (dollar sign) is not allowed.</p> <p>The value of subfield TOPC must be greater than or equal to the value in subfield FROMPC.</p>
	RESULT	see subfields	<i>Screening result</i> This two-part field specifies the next screening function to be invoked for messages that follow this rule. This field consists of subfield NEXTFN.
	NEXTFN	C7BLKDPC C7CGPA C7DSTFLD STOP	<p><i>Next screening function</i>Enter the next screening function to be performed.</p> <p>If the entry is STOP, no refinements require datafill.</p> <p>If the entry is other than STOP, datafill refinement NEXTREF.</p> <p>If the network type is CCITT7, an entry of C7CGPA is not permitted.</p>
	NEXTREF	alphanumeric (up to 4 characters)	<i>Next screening reference</i> If the entry in field NEXTFN is other than STOP, enter the value in field REFERNCE of the screening table specified in field NEXTFN, to designate the next screening function to be performed.
REMARKS		alphanumeric (1 to 8 characters)	<i>Remarks</i> This field is specified by the operating company. It can be used to identify the network or carrier to which the link is connected. Any eight-character value can be stored in this field. Avoid the use of special characters, such as +, *, /, -, and %.

## C7ALWDPC (continued)

### Field descriptions (Sheet 5 of 5)

Field	Subfield or refinement	Entry	Explanation and action
OPTIONS		see subfields	<i>Options</i> This field is used to specify CCS7 screening options. It consists of subfield OPTNAME.
	OPTNAME	\$	<i>Option name</i> Enter \$, which is the only valid entry.

### Datafill example

The following example shows sample datafill for table C7ALWDPC.

If none of the screening rules match the message being screened, the message is discarded.

### MAP display example for table C7ALWDPC

SCRNREF	SCRNRULE	REMARKS
OPTIONS		
REF4 0 ANSI7 ( 1) ( 1) ( 1)\$ ( 1) ( 1) ( 1)\$	C7BLKDPC REF5	\$
\$		
REF4 1 ANSI7 ( 1) ( 1) ( 2)\$ ( 1) ( 1) ( 2)\$	C7BLKDPC REF5	\$
\$		
REF4 2 ANSI7 ( 1) ( 1) ( 3)\$ ( 1) ( 1) ( 3)\$	C7BLKDPC REF5	\$
\$		
REF4 3 ANSI7 ( 1) ( 1) ( 4)\$ ( 1) ( 1) ( 4)\$	C7BLKDPC REF5	\$
\$		
REF4 4 ANSI7 ( 1) ( 1) ( 5)\$ ( 1) ( 1) ( 5)\$	C7BLKDPC REF5	\$
\$		

### Table history

#### STP04.0

Removed references to MDR7 screening.

---

**C7ALWDPC (end)**

---

**CSP06**

Information removed about bulk deletion workaround.

**CSP02**

Information added about the possibility of service degradation if gateway screening is not turned off.

**BCS36**

Information added about bulk deletions.

**Supplementary information**

This section provides information on datafilling table C7ALWDPC for specific applications.

**Datafill modifications****DANGER****Risk of service degradation**

A service degradation can occur if gateway screening is not turned off in table C7GTWLKS prior to making additions, deletions, or changes to table C7ALWDPC.

The table control warning is displayed at the MAP display if a user attempts to add, change, or delete tuples in table C7ALWDPC.

A similar message is displayed in all the gateway screening tables (C7AFTPC, C7ALWDPC, C7ALWGTT, C7ALWOPC, C7ALWSIO, C7BLKDPC, C7BLKOPC, C7BLKSIO for CCITT only, C7CDPA, C7CGPA, and C7DSTFLD).

**Note:** The VERIFY function must be turned on. If VERIFY is off, the above warning is not displayed.

## C7ALWGTT

---

### Table name

CCS7 Gateway STP SCCP Allowed Global Title Translation Screening Table

### Functional description

Table C7ALWGTT defines the gateway screening functions for the allowed signaling connection control part (SCCP) global title translation (GTT) types.

*Note:* All references to signaling transfer point (STP) are also applicable to STP/Service Switching Point (SSP) Integrated Nodes (INode), unless otherwise specified.

For related information, refer to table C7GTWLKS.

### Datafill sequence and implications

The following table (if required) must be datafilled before table C7ALWGTT.

- C7CDPA

The following tables (if required) must be datafilled after table C7ALWGTT:

- C7CGPA

### Table size

0 to 32 767 tuples

Up to 2000 tuples

The limit of 2000 tuples for this table depends on the datafill in the other gateway screening tables. There are a maximum of 2000 possible screening rules for all of the gateway tables (except table C7GTWLKS).

- The following restrictions apply:
- up to 1024 screening references are allowed for all tables
- up to 256 rules are allowed for each screening reference

**C7ALWGTT** (continued)**Datafill**

The following table lists datafill for table C7ALWGTT.

**Field descriptions (Sheet 1 of 2)**

<b>Field</b>	<b>Subfield or refinement</b>	<b>Entry</b>	<b>Explanation and action</b>
SCRNREF		see subfields	<i>Screening reference</i> This field is the key to the table and consists of subfields REFERNCE and RULENO.
	REFERNCE	alphanumeric (1 to 4 characters)	<i>Screening reference</i> Enter a value that uniquely identifies a global title translation (GTT) screening function.
	RULENO	0 to 255	<i>Rule number</i> Enter a number to identify a rule in a screening function. Each screening function consists of up to 256 distinct rules.
SCRNRULE		see subfields	<i>Screening rule</i> This field contains all the screening rule information and consists of subfields NETTYPE, FROMTT, TOTTT, and RESULT.
	NETTYPE	ANSI7, CCITT7, or NTC7	<i>Network type</i> Enter the network type of the screening rule.
	FROMTT	0 to 255	<i>From global title translation number</i> Enter one of the GTT numbers representing the start of the range of GTT numbers to which this rule applies. The value in subfield FROMTT must be less than or equal to the value in subfield TOTTT.
	TOTTT	0 to 255	<i>To global title translation number</i> Enter one of the GTT numbers representing the end of the range of GTT numbers to which this rule applies.  The value in subfield TOTTT must be greater than or equal to the value in subfield FROMTT.
	RESULT	see refinements	<i>Screening result</i> This subfield specifies the next screening function invoked and consists of subfield NEXTFN.

**C7ALWGTT** (continued)**Field descriptions (Sheet 2 of 2)**

Field	Subfield or refinement	Entry	Explanation and action
	NEXTFN	C7CDPA or STOP	<p><i>Next screening function</i> Enter the next screening function to be performed.</p> <p>If subfield NETTYPE contains CCITT7, STOP is the only valid entry.</p> <p>Enter STOP to stop the screening function. No additional refinements require datafill.</p> <p>Enter C7CDPA for table C7CDPA and datafill refinement NEXTREF.</p>
	NEXTREF	alphanumeric (1 to 4 characters)	<p><i>Next screening reference</i> If subfield NEXTFN contains C7CDPA, enter the value in field REFERNCE of table C7CDPA that designates the next screening function to be performed.</p>
REMARKS		alphanumeric (1 to 8 characters)	<p><i>Remarks</i> Use this field to identify the name of the network or carrier to which the link is connected. Any eight-character value can be stored in this field. Avoid the use of special characters, such as +, *, /, -, and %.</p>
OPTIONS		see subfields	<p><i>Options</i> This field is used to specify Common Channel Signaling 7 (CCS7) screening options. This field consists of subfield OPTNAME.</p>
	OPTNAME	\$	<p><i>Option name</i> Enter \$, which is the only valid entry.</p>

**Datafill example**

The following example shows sample datafill for table C7ALWGTT.



**C7ALWGTT** (continued)**MAP display example for table C7ALWGTT**

SCRNREF	SCRNRULE	REMARKS
OPTIONS		
REF7 0	ANSI7 (251)\$ (251)\$ C7CDPA REF8	\$
\$		
REF7 1	ANSI7 ( 2)\$ ( 2)\$ C7CDPA REF8	\$
\$		
REF7 2	ANSI7 ( 3)\$ ( 3)\$ C7CDPA REF8	\$
\$		
REF7 3	ANSI7 ( 4)\$ ( 4)\$ C7CDPA REF8	\$
\$		
REF7 4	ANSI7 ( 5)\$ ( 5)\$ C7CDPA REF8	\$
\$		

**Table history****STP04.0**

Removed references to MDR7 screening.

**CSP06**

Information removed about bulk deletion workaround.

**CSP02**

Information added about service degradation possibility if gateway screening is not turned off.

**BCS36**

Refinement MAXOCTET removed. Information added about bulk deletions.

**Supplementary information**

This section provides information on modifying datafill in table C7ALWGTT.

## C7ALWGTT (end)

---

### Datafill modifications



#### **DANGER**

##### **Risk of service degradation**

A service degradation can occur if gateway screening is not turned off in table C7GTWLKS prior to making additions, deletions, or changes to table C7ALWGTT.

The table control warning is displayed at the MAP display if a user attempts to add, change, or delete tuples in table C7ALWGTT.

A similar message is displayed in all the gateway screening tables (C7AFTPC, C7ALWDPC, C7ALWGTT, C7ALWOPC, C7ALWSIO, C7BLKDPC, C7BLKOPC, C7BLKSIO for CCITT only, C7CDPA, C7CGPA, and C7DSTFLD).

*Note:* The VERIFY function must be turned on. If VERIFY is off, the above warning is not displayed.

---

**C7ALWOPC**

---

**Table name**

CCS7 Gateway STP Allowed Originating Point Codes Screening Table

**Functional description**

Table C7ALWOPC is used to specify screening functions for allowed originating point codes (OPCs). Each screening function consists of a set of one or more screening rules. Each screening rule may have a different screening result.

*Note:* All references to signaling transfer point (STP) are applicable to the STP/Service Switching Point (SSP) Integrated Nodes (INode), unless otherwise specified.

For related information, refer to table C7GTWLKS.

**Datafill sequence and implications**

The following tables (if required) must be datafilled before table C7ALWOPC:

- C7ALWDPC
- C7ALWSIO
- C7BLKDPC
- C7BLKOPC
- C7BLKSIO (for network type = CCITT7 only)
- C7CGPA
- C7DSTFLD

The following table (if required) must be datafilled after table C7ALWOPC:

- C7GTWLKS

**Table size**

32 767 tuples

Up to 2000 tuples

The limit of 2000 tuples for this table depends on the datafill in the other gateway screening tables. There are a maximum of 2000 possible screening rules for all of the gateway tables (except table C7GTWLKS).

**C7ALWOPC** (continued)

- The limit of 32 767 tuples for this table depends on the datafill in the other gateway screening tables. There are a maximum of 32 767 possible screening rules for all of the gateway tables (except table C7GTWLKS). Therefore, the maximum number of tuples for the tables is 32 767 with the following restrictions:
- up to 1024 screening references for all tables
- up to 256 rules for each screening reference

**Datafill**

The following table lists datafill for table C7ALWOPC.

**Field descriptions (Sheet 1 of 2)**

Field	Subfield or refinement	Entry	Explanation and action
SCRNREF		see subfields	<i>Screening reference</i> This field is the key to the table and consists of subfields REFERENCE and RULENO.
	REFERENCE	alphanumeric (1 to 4 characters)	<i>Screening reference</i> Enter a value that identifies an allowed originating point code (OPC) screening function.
	RULENO	0 to 255	<i>Rule number</i> Enter a number to identify a rule in a screening function. Each screening function may consist of up to 256 distinct rules.
SCRNRULE		see subfields	<i>Screening rule</i> This field contains all the screening rule information and consists of subfields NETTYPE, FROMPC, TOPC, PCRANGE, and RESULT.

**C7ALWOPC** (continued)

## Field descriptions (Sheet 2 of 2)

Field	Subfield or refinement	Entry	Explanation and action
	NETTYPE	ANSI7,CCITT 7, or NTC7	<p><i>Network type</i> Enter the network type of the screening rule.</p> <p>Enter ANSI7 if the screened point codes are in ANSI format. Datafill refinements FROMPC, TOPC, and RESULT described in the table in the following section.</p> <p>Enter CCITT7 if the screened point codes are in the CCITT format. Datafill refinements PCRANGE and RESULT described in the table in the following section.</p> <p>Enter NTC7 if the screened point codes are in NTC7 format. Datafill refinements FROMPC, TOPC, and RESULT described in the table in the following section..</p> <p><b>Note:</b> All screening functions that were defined prior to the BCS30 release of this table are ANSI format.</p>

**NETTYPE = ANSI7 and NTC7**

If the entry in subfield NETTYPE is ANSI7 or NTC7, datafill refinements FROMPC, TOPC as described in the following table, then datafill refinement RESULT described in Table “Field descriptions” in section “NETTYPE = ANSI7, CCITT7, and NTC7”.

**C7ALWOPC** (continued)

**Field descriptions for conditional datafill**

Field	Subfield or refinement	Entry	Explanation and action
	FROMPC	0 to 255	<p><i>From point code</i> the NETTYPE is ANSI7, enter a full or partial OPC representing the start of the range of OPCs to which this rule applies. Up to three values can be datafilled. If less than three values are required, end the list with a \$.</p> <p>If the NETTYPE is NTC7, enter a full OPC representing the start of the range of OPCs to which this rule applies. The \$ (dollar sign) is not allowed.</p> <p>The value of field FROMPC must be less than or equal to the value in field TOPC.</p>
	TOPC	0 to 255	<p><i>To point code</i> the NETTYPE is ANSI7, enter a full or partial OPC representing the end of the range of OPCs to which this rule applies. Up to three values can be datafilled. If less than three values are required, end the list with a blank column and a \$.</p> <p>If the NETTYPE is NTC7, enter a full OPC representing the end of the range of OPCs to which this rule applies. The \$ (dollar sign) is not allowed.</p> <p>The value of field TOPC must be greater than or equal to the value in field FROMPC.</p>

**NETTYPE = CCITT7**

If the entry in subfield NETTYPE is CCITT7, datafill refinement PCRANGE and its refinements as described in the following table, then datafill field RESULT described in Table “Field descriptions” in section “NETTYPE = ANSI7, CCITT7, and NTC7”.

**C7ALWOPC** (continued)**Field descriptions for conditional datafill (Sheet 1 of 2)**

Field	Subfield or refinement	Entry	Explanation and action
	PCRANGE	see subfield	<i>CCITT point code range</i> This field consists of subfield FORMAT.
	FORMAT	BASICorINTL	<i>Format of CCITT point codes</i> For international format, enter INTL. For non-international format, enter BASIC.
	FROMPC	0 to 16383 or see subfields	<i>From point code</i> If the entry in subfield FORMAT is BASIC, enter a full OPC representing the start of the range of OPCs to which this rule applies. If the entry in subfield FORMAT is INTL, this field consists of subfields FROMZONE, FROMAREA, and FRMPOINT. Separate each subfield with a single space. The value of field FROMPC must be less than or equal to the value in field TOPC.
	FROMZONE	0 to 7	<i>From zone</i> Enter a value in the field FROMZONE for the OPC to which this rule applies.
	FROMAREA	0 to 255	<i>From area</i> Enter a value in the field FROMAREA for the OPC to which this rule applies.
	FRMPOINT	0 to 7	<i>From point</i> Enter a value in the field FRMPOINT for the OPC to which this rule applies.
TOPC		0 to 16 383 or see subfields	<i>To point code</i> This field consists of subfields TOZONE, TOAREA, and TOPOINT. Separate each subfield with a single space. If the entry in subfield FORMAT is BASIC, enter a full OPC representing the end of the range of OPCs to which this rule applies. The value of field TOPC must be greater than or equal to the value in field FROMPC.

**C7ALWOPC** (continued)**Field descriptions for conditional datafill (Sheet 2 of 2)**

Field	Subfield or refinement	Entry	Explanation and action
	TOZONE	0 to 7	<i>To zone</i> Enter a value in the field TOZONE for the OPC to which this rule applies.
	TOAREA	0 to 255	<i>To area</i> Enter a value in the field TOAREA for the OPC to which this rule applies.
	TOPOINT	0 to 7	<i>To point</i> Enter a value in the field TOPOINT for the OPC to which this rule applies.

**NETTYPE = ANSI7, CCITT7, and NTC7**

For all network types, continue datafill with refinement RESULT as described in the following table.

**Field descriptions (Sheet 1 of 2)**

Field	Subfield or refinement	Entry	Explanation and action
	RESULT	see subfields	<i>Screening result</i> This two-part field specifies the next screening function invoked for messages that follow this rule. This field consists of subfields NEXTFN and NEXTREF.
	NEXTFN	C7ALWDPCC 7ALWSIOC7 BLKDPCC7B LKOPCC7BL KSIOC7CGP AC7DSTFLD or STOP	<i>Next screening function</i> Enter the next screening function performed.  Enter STOP to stop the screening function. No refinements require datafill.  <b>Note:</b> If the network type is CCITT7, an entry of C7CGPA is not permitted.  <b>Note:</b> If the network type is ANSI7 or NTC7, an entry of C7BLKSIO is not permitted.  For all entries other than STOP, datafill refinement NEXTREF.
	NEXTREF	alphanumeric (up to 4 characters)	<i>Next screening reference</i> If the entry in subfield NEXTFN is other than STOP, enter the value in field REFERENCE of the screening table, specified in field NEXTFN, that designates the next screening function performed.



**C7ALWOPC** (continued)**Field descriptions (Sheet 2 of 2)**

Field	Subfield or refinement	Entry	Explanation and action
REMARKS		alphanumeric (1 to 8 characters)	<i>Remarks</i> This field is specified by the operating company and may be used to identify the name of the network or carrier to which the link is connected. Any eight character value may be stored in this field. Avoid the use of special characters, such as +, *, /, -, and %.
OPTIONS		see subfields	<i>Options</i> This field is used to specify CCS7 screening options. It consists of subfield OPTNAME.
	OPTNAME	\$	<i>Option name</i> Enter \$, which is the only valid entry.

**Datafill example**

The following example shows sample datafill for table C7ALWOPC.

If none of the screening rules match the message being screened, the message is discarded.

**C7ALWOPC** (continued)

**MAP display example for table C7ALWOPC**

SCRNREF											SCRNRULE	REMARKS
OPTIONS												
REF0	0	ANSI7	( 1)	( 1)	( 1)	\$ ( 1)	( 1)	( 1)	( 1)	\$	STOP	\$
	\$											
REF0	1	ANSI7	( 3)	( 3)	( 3)	\$ ( 3)	( 3)	( 3)	( 3)	\$	STOP	\$
	\$											
REF1	0	ANSI7	( 0)	( 1)	( 1)	\$ ( 0)	( 1)	( 1)	( 1)	\$	C7BLKOPC	REF2
	\$											
REF1	1	ANSI7	( 1)	( 1)	( 2)	\$ ( 1)	( 1)	( 2)	( 2)	\$	C7BLKOPC	REF2
	\$											
REF1	2	ANSI7	( 1)	( 1)	( 3)	\$ ( 1)	( 1)	( 3)	( 3)	\$	C7BLKOPC	REF2
	\$											

**Table history**

**STP04.0**

Removed references to MDR7 screening.

**CSP06**

Removed information about bulk deletion workaround.

**CSP02**

Information added about the possibility of service degradation if gateway screening is not turned off.

**BCS36**

Refinement MAXOCTETS removed. Information added about bulk deletions.

**Supplementary information**

This section provides information on modifying datafill in table C7ALWOPC.

---

**C7ALWOPC** (end)

---

**Datafill modifications****DANGER****Risk of service degradation**

A service degradation can occur if gateway screening is not turned off in table C7GTWLKS prior to making additions, deletions, or changes to table C7ALWOPC.

The control warning is displayed at the MAP display if a user attempts to add, change, or delete tuples in table C7ALWOPC.

A similar message is displayed in all the gateway screening tables (C7AFTPC, C7ALWDPC, C7ALWGTT, C7ALWOPC, C7ALWSIO, C7BLKDPC, C7BLKOPC, C7BLKSIO for CCITT only, C7CDPA, C7CGPA, and C7DSTFLD).

*Note:* The VERIFY function must be turned on. If VERIFY is off, the above warning is not displayed.

## C7ALWSIO

---

### Table name

CCS7 Gateway STP Allowed Service Information Octets Screening Table

### Functional description

Table C7ALWSIO is used to specify screening functions for allowed service information octets (SIO). Each screening function consists of a set of one or more screening rules. Each screening rule can have a different screening result.

*Note:* All references to signaling transfer point (STP) are applicable to STP/Service Switching Point (SSP) Integrated Nodes (INode), unless otherwise specified.

For related information, refer to table C7GTWLKS.

### Datafill sequence and implications

The following tables (if required) must be datafilled before table C7ALWSIO:

- C7ALWDPC
- C7BLKDPC
- C7CDPA
- C7CGPA
- C7DSTFLD

The following tables (if required) must be datafilled after table C7ALWSIO:

- C7ALWOPC
- C7BLKOPC
- C7GTWLKS

### Table size

32 767

Up to 2000 tuples for American National Standards Institute (ANSI) network type.

Up to 200 tuples for International Telecommunication Union (ITU), formerly International Telegraph and Telephone Consultative Committee (CCITT), network type.

**C7ALWSIO** (continued)**Table size restrictions**

The limit of 2000 tuples for this table depends on the datafill in the other gateway screening tables. There is a maximum of 2000 possible screening rules for all of the gateway tables (except C7GTWLKS).

The limit of 32 767 tuples for this table depends on the datafill in the other gateway screening tables. There are a maximum of 32 767 possible screening rules for all of the gateway tables (except C7GTWLKS) so the maximum number of tuples for the tables is 32 767 with the following restrictions:

- up to 1024 screening references for all tables
- up to 256 rules for each screening reference

**Datafill**

The following table lists datafill for table C7ALWSIO.

**Field descriptions (Sheet 1 of 7)**

Field	Subfield or refinement	Entry	Explanation and action
SCRNREF		see subfields	<i>Screening reference</i> This field is the key to the table and consists of subfields REFERNCE and RULENO.
	REFERNCE	alphanumeric (1 to 4 characters)	<i>Screening reference</i> Enter a value that uniquely identifies an allowed service information octet (SIO) screening function. This is the first part of a two-part key.
	RULENO	0 to 255	<i>Rule number</i> Enter a number to identify a rule in a screening function. Each screening function can consist of up to 256 distinct rules. This is the second part of a two-part key.
SCRNRULE		see subfield	<i>Screening rule</i> This field contains all of the screening rule information and consists of subfield NETTYPE and its refinements.

**C7ALWSIO** (continued)

## Field descriptions (Sheet 2 of 7)

Field	Subfield or refinement	Entry	Explanation and action
	NETTYPE	ANSI7,CCITT 7, or NTC7	<p><i>Network type</i> Enter the network type of the screening rule.</p> <p>If the network type is ANSI7, the screened point codes are in ANSI format. All screening functions defined prior to the BCS30 release of this table are of this type. Datafill refinements FROMSI, TOSI, FROMNI, TONI, FROMPRI, TOPRI, FROMH0, TOH0, FROMH1, TOH1, and RESULT.</p> <p>If the network type is CCITT7, the screened point codes are in the CCITT format. Datafill refinements FROMSI, TOSI, FROMH0, TOH0, FROMH1, TOH1, and RESULT.</p> <p>If the network type is NTC7, the screened point codes are in NTC7 format. Datafill refinements FROMSI, TOSI, FROMNI, TONI, FROMH0, TOH0, FROMH1, TOH1, and RESULT.</p>
	FROMSI	0 to 15 or \$	<p><i>From service indicators</i> Enter one of the service indicators representing the start of the range of service indicators to which this rule applies.</p> <p>The value in refinement FROMSI must be less than the value in refinement TOSI.</p> <p>If the rule includes all service indicators, enter \$, in refinements FROMSI and TOSI.</p>
	TOSI	0 to 15 or \$	<p><i>To service indicators</i> Enter one of the service indicators representing the end of the range of service indicators to which this rule applies.</p> <p>The value in refinement TOSI must be greater than the value in refinement FROMSI.</p> <p>If the rule includes all service indicators, enter \$, in refinements FROMSI and TOSI.</p>

**C7ALWSIO** (continued)

## Field descriptions (Sheet 3 of 7)

Field	Subfield or refinement	Entry	Explanation and action
	FROMNI	0 to 3 or \$	<p><i>From network indicator</i>If the entry in field NETTYPE is ANSI7 or NTC7, enter one of the network indicators representing the start of the range of network indicators to which this rule applies.</p> <p>The value in refinement FROMNI must be less than the value in refinement TONI.</p> <p>The network indicators are defined as follows:</p> <ul style="list-style-type: none"> <li>• 0 = INTL (international)</li> <li>• 1 = INTL spare (international spare)</li> <li>• 2 = NATL (national)</li> <li>• 3 = NATL spare (national spare)</li> </ul> <p>If the rule includes all network indicators, enter \$, in refinements FROMNI and TONI.</p>
	TONI	0 to 3 or \$	<p><i>To network indicator</i>If the entry in field NETTYPE is ANSI7 or NTC7, enter one of the network indicators representing the end of the range of network indicators to which this rule applies.</p> <p>The value in refinement TONI must be greater than the value in refinement FROMNI.</p> <p>The network indicators are as follows:</p> <ul style="list-style-type: none"> <li>• 0 = INTL (international)</li> <li>• 1 = INTL spare (international spare)</li> <li>• 2 = NATL (national)</li> <li>• 3 = NATL spare (national spare)</li> </ul> <p>If the rule includes all network indicators, enter \$, in refinements FROMNI and TONI.</p> <p>If the entry in field NETTYPE is CCITT7, leave this refinement blank.</p>

**C7ALWSIO** (continued)

## Field descriptions (Sheet 4 of 7)

Field	Subfield or refinement	Entry	Explanation and action
	FROMPRI	0 to 3 or \$	<p><i>From priority values</i>If the entry in field NETTYPE is ANSI7, enter one of the priority values representing the start of the range of priority values to which this rule applies.</p> <p>The value in refinement FROMPRI must be less than the value in refinement TOPRI.</p> <p>If the rule includes all priority values, enter \$, in refinements FROMPRI and TOPRI.</p> <p>If the entry in field NETTYPE is CCITT7 or NTC7, leave this refinement blank.</p>
	TOPRI	0 to 3 or \$	<p><i>To priority values</i>If the entry in field NETTYPE is ANSI7, enter one of the priority values representing the end of the range of priority values to which this rule applies.</p> <p>The value in refinement TOPRI must be greater than the value in refinement FROMPRI.</p> <p>If the rule includes all priority values, enter \$, in refinements FROMPRI and TOPRI.</p> <p>If the entry in field NETTYPE is CCITT7 or NTC7, leave this refinement blank.</p>
	FROMH0	0 to 15 or \$	<p><i>From H0</i>Enter one of the values of the H0 code representing the start of the range of H0 codes to which this rule applies.</p> <p>The value of refinement FROMH0 must be less than the value in refinement TOH0. These fields are only significant when the service indicator of the message is equal to 0, 1, 2, or 4.</p> <p>For a NETTYPE of ANSI7, these fields are only significant when the service indicator is equal to 0, 1, or 2.</p> <p>For a NETTYPE of NTC7 or CCITT, these fields are significant when the service indicator is equal to 0, 1, 2, or 4.</p> <p>If the rule includes all values of the H0 code, enter \$, in refinements FROMH0 and TOH0.</p>



**C7ALWSIO** (continued)

## Field descriptions (Sheet 5 of 7)

Field	Subfield or refinement	Entry	Explanation and action
	TOH0	0 to 15 or \$	<p><i>To H0</i> Enter one of the values of the H0 code representing the end of the range of H0 codes to which this rule applies.</p> <p>The value in refinement TOH0 is significant when the service indicator of the message is equal to 0, 1, 2, or 4.</p> <p>For a NETTYPE of ANSI7, these fields are only significant when the service indicator is equal to 0, 1, or 2.</p> <p>For a NETTYPE of NTC7 or CCITT7, these fields are only significant when the service indicator is equal to 0, 1, 2, or 4.</p> <p>If the rule includes all values of the H0 code, enter \$, in refinements FROMH0 and TOH0.</p> <p><b>Note:</b> The H0 heading code field must be NIL, if the service indicator field is not equal to zero.</p>
	FROMH1	0 to 15 or \$	<p><i>From H1</i> Enter one of the values of the H1 code representing the start of the range of H1 codes to which this rule applies.</p> <p>The value in refinement FROMH1 must be less than the value in refinement TOH1. These fields are only significant if the service indicator of the message is equal to 0, 1, 2, or 4.</p> <p>For a NETTYPE of ANSI7, these fields are only significant when the service indicator is equal to 0, 1, or 2.</p> <p>For a NETTYPE of NTC7 or CCITT7, these fields are only significant when the service indicator is equal to 0, 1, 2, or 4.</p> <p>If the rule includes all values of the H1 code, enter \$, in refinements FROMH0 and TOH1.</p>

**C7ALWSIO** (continued)

## Field descriptions (Sheet 6 of 7)

Field	Subfield or refinement	Entry	Explanation and action
	TOH1	0 to 15 or \$	<p><i>To H1</i> Enter one of the values of the H1 code representing the end of the range of H1 codes to which this rule applies.</p> <p>The value in refinement TOH1 must be greater than the value in refinement FROMH1. These fields are only significant if the service indicator of the message is equal to 0, 1, 2, or 4.</p> <p>For a NETTYPE of ANSI7, these fields are only significant when the service indicator is equal to 0, 1, or 2.</p> <p>For a NETTYPE of NTC7 or CCITT7, these fields are only significant when the service indicator is equal to 0, 1, 2, or 4.</p> <p>Where the rule includes all values of the H1 Code, enter \$, in refinements FROMH1 and TOH1.</p> <p><b>Note:</b> The H1 heading code field must be NIL, if the service indicator field is not equal to zero. The H1 heading code field must not be NIL, if the H0 heading code field is not NIL.</p>
	RESULT	see subfield	<p><i>Screening result</i> This two-part field specifies the next screening function to be invoked for messages that follow this rule. This refinement consists of subfield NEXTFN.</p>

**C7ALWSIO** (continued)

## Field descriptions (Sheet 7 of 7)

Field	Subfield or refinement	Entry	Explanation and action
	NEXTFN	C7ALWDPC C7BLKDPC C7CDPA C7CGPAC7B LKSIOC7DST FLD STOP	<p><i>Next screening function</i> Enter the next screening function to be performed.</p> <p>If the entry is STOP, no refinements require datafill.</p> <p>If the entry is other than STOP, datafill refinement NEXTREF.</p> <p>If the network type is CCITT7, an entry of C7CDPA is not permitted.</p> <p>If the network type is ANSI7, an entry of C7BLKSIO is not permitted.</p> <p>If the network type is ANSI7 or NTC7, an entry of C7BLKSIO is not permitted.</p> <ul style="list-style-type: none"> <li>• <i>Note:</i> The next screening function field cannot be C7CDPA or C7CGPA if the following conditions apply:</li> <li>• the H0 heading code field and the H1 heading code field are both not NIL, or</li> <li>• the service indicator field is not equal to 3.</li> </ul>
	NEXTREF	alphanumeric (up to 4 characters)	<i>Next screening reference</i> If the entry in field NEXTFN is other than STOP, enter the value in subfield REFERENCE of the screening table, specified in field NEXTFN, that designates the next screening function to be performed.
REMARKS		alphanumeric (1 to 8 characters)	<i>Remarks</i> This field is specified by the operating company and can be used to identify the name of the network or carrier to which the link is connected. Any eight-character value can be stored in this field. Avoid the use of special characters, such as +, *, /, -, and %
OPTIONS		see subfields	<i>Options</i> This field is used to specify CCS7 screening options. It consists of subfield OPTNAME.
	OPTNAME	\$	<i>Option name</i> Enter \$, which is the only valid entry.

## C7ALWSIO (continued)

### Datafill example

The following example shows sample datafill for table C7ALWSIO.

If none of the screening rules match the message being screened, the message is discarded.

### MAP display example for table C7ALWSIO

SCRNREF	SCRNRULE	REMARKS
OPTIONS		
REF3 0	ANSI7 ( 0)\$ ( 0)\$ 0 3 0 3 ( 0)\$ ( 0)\$ ( 0)\$ ( 0)\$	C7ALWDPC REF4 \$
REF3 1	ANSI7 ( 0)\$ ( 0)\$ 0 3 0 3 ( 0)\$ ( 0)\$ ( 1)\$ ( 1)\$	C7ALWDPC REF4 \$
REF3 2	ANSI7 ( 0)\$ ( 0)\$ 0 3 0 3 ( 0)\$ ( 0)\$ ( 2)\$ ( 2)\$	C7ALWDPC REF4 \$
REF3 3	ANSI7 ( 0)\$ ( 0)\$ 0 3 0 3 ( 0)\$ ( 0)\$ ( 3)\$ ( 3)\$	C7ALWDPC REF4 \$
REF3 4	ANSI7 ( 0)\$ ( 0)\$ 0 3 0 3 ( 0)\$ ( 0)\$ ( 4)\$ ( 4)\$	C7ALWDPC REF4 \$

### Table history

#### STP04.0

Removed references to MDR7 screening.

#### CSP06

Information removed about bulk deletion workaround.

#### CSP02

Information added about the possibility of service degradation if gateway screening is not turned off.

#### BCS36

Information added about bulk deletions.

## Supplementary information

This section provides information on modifying datafill in table C7ALWSIO.

### Datafill modifications



#### **DANGER**

##### **Risk of service degradation**

A service degradation can occur if gateway screening is not turned off in table C7GTWLKS prior to making additions, deletions, or changes to table C7ALWSIO.

The table control warning is displayed at the MAP display if a user attempts to add, change, or delete tuples in table C7ALWSIO.

A similar message is displayed in all the gateway screening tables (C7AFTPC, C7ALWDPC, C7ALWGTT, C7ALWOPC, C7ALWSIO, C7BLKDPC, C7BLKOPC, C7BLKSIO for CCITT only, C7CDPA, C7CGPA, and C7DSTFLD).

**Note:** The VERIFY function must be turned on. If VERIFY is off, the above warning is not displayed.

## C7BLKDPC

---

### Table name

CCS7 Gateway STP Blocked Destination Point Codes Screening Table

### Functional description

Table C7BLKDPC specifies screening functions for blocked destination point codes (DPC). Each screening function consists of a set of one or more screening rules. For each screening reference, the default rule must be the first specified rule. Each screening rule can have a different screening result.

*Note:* All references to signaling transfer point (STP) are also applicable to STP/Service Switching Point (SSP) Integrated Nodes (INode), unless otherwise specified.

For related information, refer to table C7GTWLKS.

### Datafill sequence and implications

The following tables (if required) must be datafilled before table C7BLKDPC.

- C7CGPA (network type ANSI7 only)
- C7DSTFLD

The following tables (if required) must be datafilled after table C7BLKDPC:

- C7ALWDPC
- C7ALWOPC
- C7ALWSIO
- C7BLKSIO (for network type CCITT7 only)
- C7BLKOPC
- C7GTWLKS

### Table size

32 767

Up to 2000 tuples

The limit of 2000 tuples for this table depends on the datafill in the other gateway screening tables. There are a maximum of 2000 possible screening rules for all of the gateway tables (except table C7GTWLKS).

**C7BLKDPC** (continued)

The limit of 32 767 tuples for this table depends on the datafill in the other gateway screening tables. There are a maximum of 32 767 possible screening rules for all of the gateway tables (except table C7GTWLKS), therefore the maximum number of tuples for the tables is 32 767 with the following restrictions:

- up to 1024 screening references for all tables
- up to 256 rules for each screening reference

**Datafill**

The following table lists datafill for table C7BLKDPC.

**Field descriptions (Sheet 1 of 2)**

Field	Subfield or refinement	Entry	Explanation and action
SCRNREF		see subfields	<i>Screening reference</i> This field is the key to the table and consists of subfields REFERNCE and RULENO.
	REFERNCE	alphanumeric (1 to 4 characters)	<i>Screening reference</i> Enter a value that identifies a blocked destination point code (DPC) screening function.
	RULENO	0 to 255	<i>Rule number</i> Enter a number to identify a rule in a screening function. Each screening function can consist of up to 256 distinct rules.  A value of 0 must be used if subfield RULETYPE has a value of DEFAULT.

**C7BLKDPC** (continued)

## Field descriptions (Sheet 2 of 2)

Field	Subfield or refinement	Entry	Explanation and action
SCRNRULE		see subfields	<i>Rule type</i> This field contains all of the screening rule information and consists of subfield NETTYPE.
	NETTYPE	ANSI7, CCITT7, or NTC7	<p><i>Network type</i>Enter the network type of the screening rule.</p> <p>Enter ANSI7 if the screened point codes are in the ANSI format and datafill refinement RULE as described in Table "Field descriptions for conditional datafill" on the next page..</p> <p>Enter CCITT7 if the screened point codes are in the CCITT7 format and datafill refinement RULE as described in Table "Field descriptions for conditional datafill" in section "NETTYPE = CCITT7".</p> <p>Enter NTC7 if the screened point codes are in the NTC7 format and datafill refinement RULE as described in Table "Field descriptions for conditional datafill" on the next page.</p> <p>Each rule of screening function must be of the same network type. The network type of a screening function cannot be changed.</p>

**NETTYPE = ANSI7 and NTC7**

If the entry in subfield NETTYPE is ANSI7 or NTC7, datafill refinement RULE as described in the following table, then go to field REMARKS as described in Table "Field descriptions" in the Section "For all network types".



**C7BLKDPC** (continued)**Field descriptions for conditional datafill (Sheet 1 of 3)**

Field	Subfield or refinement	Entry	Explanation and action
	RULE	see subfield	<i>Rule</i> This field defines the screening rule and consists of subfield RULETYPE.
	RULETYPE	BLOCK or DEFAULT	<p><i>Rule type</i>This field identifies the type of rule and the range of DPCs covered by this rule.</p> <p>Enter DEFAULT if no other rule applies and datafill refinement RESULT. For a DEFAULT rule</p> <ul style="list-style-type: none"> <li>• field RULENO must contain 0 (zero)</li> <li>• be the first rule specified in field REFERNCE</li> <li>• have a result associated with it in field RESULT</li> </ul> <p>Subfields FROMPC and TOPC are not specified with the DEFAULT rule type.</p> <p>Enter BLOCK to identify a range of DPCs that are blocked and datafill refinement BLOCK. A BLOCK rule must</p> <ul style="list-style-type: none"> <li>• have a value between 1 and 255 datafilled in field RULENO</li> <li>• be added after the default rule for a screening reference in field REFERNCE</li> <li>• have associated subfields TOPC and FROMPC, or PCRANGE</li> </ul>
BLOCK		see subfield	<i>Block</i> If the entry in subfield RULETYPE is BLOCK, datafill this refinement. This field consists of subfields FROMPC and TOPC.

**C7BLKDPC** (continued)

## Field descriptions for conditional datafill (Sheet 2 of 3)

Field	Subfield or refinement	Entry	Explanation and action
	FROMPC	0 to 255	<p><i>From point code</i> For a NETTYPE of ANSI7, enter a full DPC representing the start of the range of DPCs to which this rule applies. Up to three values can be datafilled. If less than three values are required, end the list with a \$.</p> <p>For a NETTYPE of NTC7, enter a full DPC representing the start of the range of DPCs to which this rule applies. The \$ (dollar sign) is not allowed.</p> <p>The value of field FROMPC must be less than or equal to the value in field TOPC.</p>
	TOPC	0 to 255	<p><i>To point code</i> For a NETTYPE of ANSI7, enter a full or partial originating point code (OPC) representing the end of the range of OPCs to which this rule applies. Up to three values can be datafilled. If less than three values are required, end the list with a blank column and a \$.</p> <p>For a NETTYPE of NTC7, enter a full OPC representing the end of the range of OPCs to which this rule applies. The \$ (dollar sign) is not allowed.</p> <p>The value of field TOPC must be greater than or equal to the value in field FROMPC.</p>
RESULT		see subfields	<p><i>Result</i> If the entry in subfield RULETYPE is DEFAULT, datafill this refinement. This field consists of subfields NEXTFN and NEXTREF.</p>

**C7BLKDPC** (continued)**Field descriptions for conditional datafill (Sheet 3 of 3)**

Field	Subfield or refinement	Entry	Explanation and action
	NEXTFN	C7DSTFLD or STOP	<p><i>Next screening function</i> Enter the next screening function to be performed.</p> <p>If the entry is STOP, no refinements require datafill.</p> <p>If the entry is C7DSTFLD, datafill refinement NEXTREF.</p> <p>If the network type is CCITT7, an entry of C7CGPA in this field is not permitted.</p>
	NEXTREF	alphanumeric	<p><i>Next screening referencelf</i> entry in subfield NEXTFN is other than STOP, enter the value in field REFERNCE of the screening table that was specified in field NEXTFN that designates the next screening function to be performed.</p>

**NETTYPE = CCITT7**

If the entry in subfield NETTYPE is CCITT7, datafill refinement RULE as described in the following table, then go to field REMARKS as described in Table “Field descriptions” in Section “For all network types”..

**C7BLKDPC** (continued)**Field descriptions for conditional datafill (Sheet 1 of 3)**

Field	Subfield or refinement	Entry	Explanation and action
RULE		see subfields	<i>Rule</i> This field defines the screening rule and consists of subfields RULETYPE.
	RULETYPE	BLOCK or DEFAULT	<p><i>Rule type</i>This field identifies the type of rule and the range of DPCs covered by this rule.</p> <p>Enter DEFAULT if no other rule applies and datafill refinement RESULT. For a DEFAULT rule</p> <ul style="list-style-type: none"> <li>field RULENO must contain 0 (zero)</li> <li>be the first rule specified in field REFERNCE</li> <li>have a result associated with it in field RESULT</li> </ul> <p>Subfields FROMPC and TOPC are not specified with the DEFAULT rule type.</p> <p>Enter BLOCK to identify a range of DPCs that are blocked and datafill refinement BLOCK. A BLOCK rule must</p> <ul style="list-style-type: none"> <li>have a value between 1 and 255 datafilled in field RULENO</li> <li>be added after the default rule for a screening reference in field REFERNCE</li> <li>have associated subfields TOPC and FROMPC, or PCRANGE.</li> </ul>
BLOCK		see subfield	<i>Block</i> This field consists of subfield PCRANGE.
	PCRANGE	see subfield	<i>CCITT point code range</i> This field consists of subfield FORMAT.
	FORMAT	BASIC or INTL	<p><i>Format of CCITT point codes</i>For international format, enter INTL.</p> <p>For non-international format, enter BASIC.</p>

**C7BLKDPC** (continued)

## Field descriptions for conditional datafill (Sheet 2 of 3)

Field	Subfield or refinement	Entry	Explanation and action
FROMPC		0 to 16383 or see subfields	<p><i>From point code</i>If the entry in subfield FORMAT is BASIC, enter a full originating point code (OPC) representing the start of the range of OPCs to which this rule applies.</p> <p>If the entry in subfield FORMAT is INTL, this field consists of subfields FROMZONE, FROMAREA, and FRMPOINT. Separate each subfield with a single space.</p> <p>The value of field FROMPC must be less than or equal to the value in field TOPC.</p>
	FROMZONE	0 to 7	<p><i>From zone</i>Enter a value in the field FROMZONE for the OPC to which this rule applies.</p>
	FROMAREA	0 to 255	<p><i>From area</i>Enter a value in the field FROMAREA for the OPC to which this rule applies.</p>
	FROMPOINT	0 to 7	<p><i>From point</i>Enter a value in the field FROMPOINT for the OPC to which this rule applies.</p>
	TOPC	see subfields	<p><i>To point code</i>This field consists of subfields TOZONE, TOAREA, and TOPOINT. Separate each subfield with a single space.</p> <p>The value of field TOPC must be greater than or equal to the value in field FROMPC.</p>
	TOZONE	0 to 7	<p><i>To zone</i>Enter a value in the field TOZONE for the OPC to which this rule applies.</p>
	TOAREA	0 to 255	<p><i>To area</i>Enter a value in the field TOAREA for the OPC to which this rule applies.</p>
	TOPOINT	0 to 7	<p><i>To point</i>Enter the point of the OPC to which this rule applies.</p>
RESULT		see subfields	<p><i>Result</i>If the entry in subfield RULETYPE is DEFAULT, datafill this refinement. This field is consists of subfields NEXTFN and NEXTREF.</p>

**C7BLKDPC** (continued)**Field descriptions for conditional datafill (Sheet 3 of 3)**

Field	Subfield or refinement	Entry	Explanation and action
	NEXTFN	C7CGPA C7DSTFLD or STOP	<p><i>Next screening function</i> Enter the next screening function to be performed.</p> <p>If the entry is STOP, no refinements require datafill.</p> <p>If the entry is C7CGPA or C7DSTFLD, datafill refinement NEXTREF.</p> <p>If the network type is CCITT7, an entry of C7CGPA in this field is not permitted.</p>
	NEXTREF	alphanumeric	<p><i>Next screening reference</i> If entry in subfield NEXTFN is other than STOP, enter the value in field REFERENCE of the screening table that is specified in field NEXTFN that designates the next screening function to be performed.</p>

**For all network types**

For all network types, continue datafill with fields REMARKS and OPTIONS as described in the following table.

**Field descriptions**

Field	Subfield or refinement	Entry	Explanation and action
REMARKS		alphanumeric (1 to 8 characters)	<p><i>Remarks</i> This field is specified by the operating company and can be used to identify the name of the network or carrier to which the link is connected. Any eight-character value can be stored in this field. Avoid the use of special characters, such as +, *, /, -, and %.</p>
OPTIONS		see subfields	<p><i>Options</i> This field is used to specify CCS7 screening options. It consists of subfield OPTNAME.</p>
	OPTNAME	\$	<p><i>Option name</i> Enter \$, which is the only valid entry.</p>

**Datafill example**

The following example shows sample datafill for table C7BLKDPC.

**C7BLKDPC** (continued)

The screening rules in a “blocked” screening table specify those values in the CCS7 message that are not allowed. If one of the screening rules matches the message being screened, then the message is not allowed and is discarded. If no screening rule matches the message being screened it is routed to the next screening table by the DEFAULT rule.

**MAP display example for table C7BLKDPC**

SCRNREF	SCRNRULE	REMARKS
OPTIONS		
REF5 0	ANSI7 DEFAULT C7CGPA REF6	\$
\$		
REF5 1	ANSI7 BLOCK ( 1) ( 1) ( 2)\$ ( 1) ( 1) ( 2)\$	\$
\$		
REF5 2	ANSI7 BLOCK ( 1) ( 1) ( 3)\$ ( 1) ( 1) ( 3)\$	\$
\$		
REF5 3	ANSI7 BLOCK ( 1) ( 1) ( 4)\$ ( 1) ( 1) ( 4)\$	\$
\$		
REF5 4	ANSI7 BLOCK ( 1) ( 1) ( 5)\$ ( 1) ( 1) ( 5)\$	\$
\$		

**Table history****STP04.0**

Removed references to MDR7 screening.

**CSP06**

Information removed about bulk deletion workaround.

**CSP02**

Information added about the possibility of service degradation if gateway screening is not turned off.

**BCS36**

Refinement MAXOCTET removed. Information added about bulk deletions.

**Supplementary information**

This section provides information on deleting datafill in table C7BLKDPC.

## C7BLKDPC (end)

---

### Datafill modifications



**DANGER**

**Risk of service degradation**

A service degradation can occur if gateway screening is not turned off in table C7GTWLKS prior to making additions, deletions, or changes to table C7BLKDPC.

The table control warning is displayed at the MAP display if a user attempts to add, change, or delete tuples in table C7BLKDPC.

A similar message is displayed in all the gateway screening tables (C7AFTPC, C7ALWDPC, C7ALWGTT, C7ALWOPC, C7ALWSIO, C7BLKDPC, C7BLKOPC, C7BLKSIO for CCITT only, C7CDPA, C7CGPA, and C7DSTFLD).

*Note:* The VERIFY function must be turned on. If VERIFY is off, this warning is not displayed.



---

**C7BLKOPC**

---

**Table name**

CCS7 Gateway STP Blocked Originating Point Codes Screening Table

**Functional description**

Table C7BLKOPC specifies screening functions for blocked originating point codes (OPC). Each screening function consists of a set of one or more screening rules. For each screening reference, the DEFAULT rule must be the first specified rule. Each screening rule can have a different screening result.

*Note:* All references to signaling transfer point (STP) are also applicable to STP/Service Switching Point (SSP) Integrated Nodes (INode), unless otherwise specified.

For related information, refer to table C7GTWLKS.

**Datafill sequence and implications**

The following tables (if required) must be datafilled before table C7BLKOPC:

- C7ALWDPC
- C7ALWSIO
- C7BLKDPC
- C7BLKSIO (network type CCITT7 only)
- C7CGPA
- C7DSTFLD

The following tables (if required) must be datafilled after table C7BLKOPC:

- C7ALWOPC
- C7GTWLKS

**Table size**

32 767 tuples

Up to 2000 tuples

The limit of 2000 tuples for this table depends on the datafill in the other gateway screening tables. There are a maximum of 2000 possible screening rules for all of the gateway tables (except table C7GTWLKS).

**C7BLKOPC** (continued)

- The limit of 32 767 tuples for this table depends on the datafill in the other gateway screening tables. There are a maximum of 32 767 possible screening rules for all of the gateway tables (except table C7GTWLKS), therefore the maximum number of tuples for the tables is 32, 767 with the following restrictions:
- up to 1024 screening references for all tables
- up to 256 rules for each screening reference

**Datafill**

The following table lists datafill for table C7BLKOPC.

**Field descriptions (Sheet 1 of 2)**

Field	Subfield or refinement	Entry	Explanation and action
SCRNREF		see subfields	<i>Screening reference</i> This field is the key to the table and consists of subfields REFERENCE and RULENO.
	REFERENCE	alphanumeric (1 to 4 characters)	<i>Screening reference</i> Enter a value that uniquely identifies a blocked destination point code (DPC) screening function.
	RULENO	0 to 255	<i>Rule number</i> Enter a number to identify a rule in a screening function. Each screening function can consist of up to 256 distinct rules. This is the second part of a two part key.  A value of 0 (zero) can only be used if subfield RULETYPE has a value of DEFAULT.
SCRNRULE		see subfields	<i>Rule type</i> This field contains all of the screening rule information and consists of subfield NETTYPE.
	NETTYPE	ANSI7, CCITT7, or NTC7	<i>Network type</i> Enter the network type of the screening rule.  Enter ANSI7 if the point codes screened are in the ANSI format and datafill refinement RULE described in the following table.

**C7BLKOPC** (continued)**Field descriptions (Sheet 2 of 2)**

Field	Subfield or refinement	Entry	Explanation and action
			<p>Enter CCITT7 if the point codes screened are in the CCITT7 format and datafill refinement RULE described in the field description table in Section "NETTYPE = CCITT7"..</p> <p>Enter NTC7 if the point codes screened are in the NTC7 format and datafill refinement RULE described in the following table..</p> <p>Each rule of screening function must be of the same network type. The network type of a screening function cannot be changed.</p>

**NETTYPE = ANSI7 and NTC7**

If the entry in subfield NETTYPE is ANSI7 or NTC7, datafill refinement RULE as described in the following table, then go to field REMARKS described in the field descriptions table in Section "For all network types".

**C7BLKOPC** (continued)**Field descriptions for conditional datafill (Sheet 1 of 3)**

Field	Subfield or refinement	Entry	Explanation and action
	RULE	see subfield	<i>Rule</i> This field defines the screening rule and consists of subfield RULETYPE.
	RULETYPE	BLOCK or DEFAULT	<p><i>Rule type</i>This field identifies the type of rule and the range of DPC covered by this rule.</p> <p>Enter DEFAULT if no other rule applies and datafill refinement RESULT. For a DEFAULT rule</p> <ul style="list-style-type: none"> <li>• field RULENO must contain 0 (zero)</li> <li>• be the first rule specified in field REFERNCE</li> <li>• have a result associated with it in field RESULT</li> </ul> <p>Subfields FROMPC and TOPC are not specified with the DEFAULT rule type.</p> <p>Enter BLOCK to identify a range of DPCs that are blocked and datafill refinement BLOCK. A BLOCK rule must</p> <ul style="list-style-type: none"> <li>• have a value between 1 and 255 datafilled in field RULENO</li> <li>• be added after the default rule for a screening reference in field REFERNCE</li> <li>• have associated subfields TOPC and FROMPC, or PCRANGE.</li> </ul>
	BLOCK	see subfield	<i>Block</i> If the entry in subfield RULETYPE is BLOCK, datafill this refinement. This field consists of subfields FROMPC and TOPC.

**C7BLKOPC** (continued)

## Field descriptions for conditional datafill (Sheet 2 of 3)

Field	Subfield or refinement	Entry	Explanation and action
	FROMPC	0 to 255	<p><i>From point code</i> For a NETTYPE of ANSI7, enter a full or partial originating point code (OPC) representing the start of the range of OPCs to which this rule applies. Up to three values can be datafilled. If less than three values are required, end the list with a \$.</p> <p>For a NETTYPE of NTC7, enter a full OPC representing the start of the range of OPCs to which this rule applies. The \$ (dollar sign) is not allowed.</p> <p>The value of field FROMPC must be less than or equal to the value in field TOPC.</p> <ul style="list-style-type: none"> <li>• The network identifier of fields FROMPC and TOPC must be in the range 1 to 255 (a value of 0 is not valid).</li> <li>• The point code range represented by fields FROMPC and TOPC is one of the following types: <ul style="list-style-type: none"> <li>— a single point code</li> <li>— a range of, or all of, the point codes in a network cluster</li> <li>— a range of, or all of, the network clusters in a network identifier</li> <li>— a range of, or all of, the network identifiers in the entire range of point codes</li> </ul> </li> </ul>
	TOPC	0 to 255	<p><i>To point code</i> For a NETTYPE of ANSI7, enter a full or partial OPC representing the end of the range of OPCs to which this rule applies. Up to three values can be datafilled. If less than three values are required, end the list with a blank column and a \$.</p> <p>For a NETTYPE of NTC7, enter a full OPC representing the end of the range of OPCs to which this rule applies. The \$ (dollar sign) is not allowed.</p> <p>The value of field TOPC must be greater than or equal to the value in field FROMPC.</p>

**C7BLKOPC** (continued)**Field descriptions for conditional datafill (Sheet 3 of 3)**

Field	Subfield or refinement	Entry	Explanation and action
	RESULT	see subfields	<i>Result</i> If the entry in subfield RULETYPE is DEFAULT, datafill this refinement. This field consists of subfields NEXTFN and NEXTREF.
	NEXTFN	C7ALWDPC C7ALWSIO C7BLKDPC C7CGPA C7DSTFLD or STOP	<i>Next screening function</i> Enter the next screening function to be performed.  If the entry is STOP, no refinements require datafill.  If the entry is any entry other than STOP, datafill refinement NEXTREF.
	NEXTREF	alphanumeric	<i>Next screening reference</i> If entry in subfield NEXTFN is other than STOP, enter the value, in field REFERNCE of the screening table that is specified in field NEXTFN, that designates the next screening function to be performed.

**NETTYPE = CCITT7**

If the entry in subfield NETTYPE is CCITT7, datafill refinement RULE as described below, then go to field REMARKS described in the field descriptions table in Section “For all network types”.

**C7BLKOPC** (continued)**Field descriptions for conditional datafill (Sheet 1 of 3)**

Field	Subfield or refinement	Entry	Explanation and action
	RULE	see subfield	<i>Rule</i> This field defines the screening rule and consists of subfield RULETYPE.
	RULETYPE	BLOCK or DEFAULT	<p><i>Rule type</i>This field identifies the type of rule and the range of destination point codes (DPC) covered by this rule.</p> <p>Enter BLOCK to identify a range of DPCs that are blocked and datafill refinement BLOCK. A BLOCK rule must</p> <ul style="list-style-type: none"> <li>• have a value between 1 and 255 datafilled in field RULENO</li> <li>• be added after the default rule for a screening reference in field REFERNCE</li> <li>• have associated subfields TOPC and FROMPC, or PCRANGE</li> </ul> <p>Enter DEFAULT if no other rule applies and datafill refinement RESULT described later in this table. For a DEFAULT rule</p> <ul style="list-style-type: none"> <li>• field RULENO must contain 0 (zero)</li> <li>• be the first rule specified in field REFERNCE</li> <li>• have a result associated with it in field RESULT</li> </ul> <p>Subfields FROMPC and TOPC are not specified with the DEFAULT rule type.</p>
	BLOCK	see subfield	<i>Block</i> This field consists of subfield PCRANGE.
	PCRANGE	see subfield	<i>CCITT point code range</i> This field consists of subfield FORMAT.
	FORMAT	BASIC or INTL	<p><i>Format of CCITT point codes</i>For international format, enter INTL.</p> <p>For noninternational format, enter BASIC.</p>

**C7BLKOPC** (continued)

## Field descriptions for conditional datafill (Sheet 2 of 3)

Field	Subfield or refinement	Entry	Explanation and action	
TOPC	FROMPC	0 to 16 383 or see subfields	<p><i>From point code</i> If the entry in subfield FORMAT is BASIC, enter a full OPC representing the start of the range of OPCs to which this rule applies.</p> <p>If the entry in subfield FORMAT is INTL, this field consists of subfields FROMZONE, FROMAREA, and FRMPOINT. Separate each subfield with a single space.</p> <p>The value of field FROMPC must be less than or equal to the value in field TOPC.</p>	
	FROMZONE	0 to 7	<i>From zone</i> Enter a value in the field FROMZONE for the OPC to which this rule applies.	
	FROMAREA	0 to 255	<i>From area</i> Enter a value in the field FROMAREA for the OPC to which this rule applies.	
	FROMPOINT	0 to 7	<i>From point</i> Enter a value in the field FROMPOINT for the OPC to which this rule applies.	
			0 to 16 383 or see subfields	<p><i>To point code</i> This field consists of subfields TOZONE, TOAREA, and TOPOINT. Separate each subfield with a single space.</p> <p>If the entry in subfield FORMAT is BASIC, enter a full OPC representing the end of the range of the OPCs to which this rules applies.</p> <p>The value of field TOPC must be greater than or equal to the value in field FROMPC.</p>
	TOZONE	0 to 7	<i>To zone</i> Enter a value for the field TOZONE for the OPC to which this rule applies.	
	TOAREA	0 to 255	<i>To area</i> Enter a value for the field TOAREA for the OPC to which this rule applies.	
	TOPOINT	0 to 7	<i>To point</i> Enter a value for the field TOPOINT for the OPC to which this rule applies.	



**C7BLKOPC** (continued)**Field descriptions for conditional datafill (Sheet 3 of 3)**

Field	Subfield or refinement	Entry	Explanation and action
	RESULT	see subfields	<i>Result</i> If the entry in subfield RULETYPE is DEFAULT, datafill this refinement. This field consists of subfields NEXTFN and NEXTREF.
	NEXTFN	C7ALWDPC C7ALWSIO C7BLKDPC C7BLKSIO C7DSTFLD or STOP	<i>Next screening function</i> Enter the next screening function to be performed.  If the entry is STOP, no refinements require datafill.  If the entry is any entry other than STOP, datafill refinement NEXTREF.  If the network type is CCITT7, an entry of C7CGPA in this field is not permitted.
	NEXTREF	alphanumeric	<i>Next screening reference</i> If entry in subfield NEXTFN is other than STOP, enter the value, in field REFERNCE of the screening table that is specified in field NEXTFN, that designates the next screening function to be performed.

**For all network types**

For all network types, continue datafill with fields REMARKS and OPTIONS as described in the following table.

**Field descriptions (Sheet 1 of 2)**

Field	Subfield or refinement	Entry	Explanation and action
REMARKS		alphanumeric (1 to 8 characters)	<i>Remarks</i> This field is specified by the operating company and can be used to identify the name of the network or carrier to which the link is connected. Any eight-character value can be stored in this field. Avoid the use of special characters, such as +, *, /, -, and %.

## C7BLKOPC (continued)

### Field descriptions (Sheet 2 of 2)

Field	Subfield or refinement	Entry	Explanation and action
OPTIONS		see subfields	<i>Options</i> This field is used to specify CCS7 screening options. It consists of subfield OPTNAME.
	OPTNAME	\$	<i>Option name</i> Enter \$, which is the only valid entry.

### Datafill example

The following example shows sample datafill for table C7BLKOPC.

The screening rules in a “blocked” screening table specify the values in the CCS7 message that are not allowed. If one of the screening rules matches the screened message, the message is not allowed and is discarded. If no screening rule matches the screened message, it is routed to the next screening table by the DEFAULT rule (subfield RULETYPE).

### MAP display example for table C7BLKOPC

SCRNREF	SCRNRULE	REMARKS
OPTIONS		
REF2 0	ANSI7 DEFAULT C7CGPA REF6	\$
\$		
REF2 1	ANSI7 BLOCK ( 1) ( 1) ( 2)\$ ( 1) ( 1) ( 2)\$	\$
\$		
REF2 2	ANSI7 BLOCK ( 1) ( 1) ( 3)\$ ( 1) ( 1) ( 3)\$	\$
\$		
REF2 3	ANSI7 BLOCK ( 1) ( 1) ( 4)\$ ( 1) ( 1) ( 4)\$	\$
\$		
REF2 4	ANSI7 BLOCK ( 1) ( 1) ( 5)\$ ( 1) ( 1) ( 5)\$	\$
\$		

### Table history

#### STP04.0

Removed references to MDR7 screening.

---

**C7BLKOPC** (end)

---

**CSP06**

Information removed about bulk deletion workaround.

**CSP02**

Information added about the possibility of service degradation if gateway screening is not turned off.

**BCS36**

Refinement MAXOCTET removed. Information added about bulk deletions.

**Supplementary information**

This section provides information on modifying datafill in table C7BLKOPC.

**Datafill modifications****DANGER****Risk of service degradation**

A service degradation can occur if gateway screening is not turned off in table C7GTWLKS prior to making additions, deletions, or changes to table C7BLKSIO (for CCITT only).

The previous table control warning is displayed at the MAP display if a user attempts to add, change, or delete tuples in table C7BLKSIO.

A similar message is displayed in all the gateway screening tables (C7AFTPC, C7ALWDPC, C7ALWGTT, C7ALWOPC, C7ALWSIO, C7BLKDPC, C7BLKOPC, C7BLKSIO for CCITT only, C7CDPA, C7CGPA, and C7DSTFLD).

**Note:** The VERIFY function must be turned on. If VERIFY is off, the above warning is not displayed.

## C7BLKSIO

---

### Table name

CCS7 Gateway STP Blocked Service Information Octets Screening Table

### Functional description

Table C7BLKSIO is used to specify screening functions for blocked service information octets (SIO). Each screening function consists of a set of one or more screening rules. For each screening reference, the DEFAULT rule must be the first specified rule. Each screening rule can have a different screening result.

*Note:* All references to signaling transfer point (STP) are applicable to STP/Service Switching Point (SSP) Integrated Nodes (INode), unless otherwise specified.

### Datafill sequence and implications

There is no requirement to datafill other tables prior to table C7BLKSIO.

### Table size

0 to 32 767 tuples

Up to 2000 tuples for American National Standards Institute (ANSI) network type.

Up to 200 tuples for International Telecommunication Union (ITU), formerly International Telegraph and Telephone Consultative Committee (CCITT), network type.

The limit of 2000 tuples for this table depends on the datafill in the other gateway screening tables. There are a maximum of 2000 possible screening rules for all of the gateway tables (except table C7GTWLKS).

The limit of 32 767 tuples for this table depends on the datafill in the other gateway screening tables. There are a maximum of 32 767 possible screening rules for all of the gateway tables (except table C7GTWLKS), therefore the maximum number of tuples for the tables is 32 767 with the following restrictions:

- up to 1024 screening references for all tables
- up to 256 rules for each screening reference

**C7BLKSIO** (continued)**Datafill**

The following table lists datafill for table C7BLKSIO.

**Field descriptions (Sheet 1 of 5)**

Field	Subfield or refinement	Entry	Explanation and action
SCRNREF		see subfields	<i>Screening reference</i> This field is the key to the table and consists of subfields REFERNCE and RULENO.
	REFERNCE	alphanumeric (1 to 4 characters)	<i>Screening reference</i> Enter a value that uniquely identifies a blocked service information octet (SIO) screening function.
	RULENO	0 to 255	<i>Rule number</i> Enter a number to identify a rule in a screening function. Each screening function can consist of up to 256 distinct rules.
SCRNRULE		see subfield	<i>Rule type</i> This field contains all of the screening rule information and consists of subfield NETTYPE.
	NETTYPE	CCITT7	<i>Network type</i> Enter the network type of the screening rule.  Enter CCITT7 if the point codes screened are in the CCITT7 format and datafill refinement RULE.  Each rule of a screening function must be of the same network type. The network type of a screening function cannot be changed.
	RULE	see subfield	<i>Rule</i> This field defines the screening rule and includes the subfield RULETYPE.

**C7BLKSIO** (continued)

## Field descriptions (Sheet 2 of 5)

Field	Subfield or refinement	Entry	Explanation and action
	RULETYPE	BLOCK or DEFAULT	<p><i>Rule type</i>This field identifies the type of rule and the range of service information octets (SIO).</p> <p>Enter BLOCK to identify a range of SIOs that are blocked and datafill refinement BLOCK. A BLOCK rule must</p> <ul style="list-style-type: none"> <li>• have a value between 1 and 255 datafilled in field RULENO</li> <li>• be added after the default rule for a screening reference in field REFERENCE</li> </ul> <p>Enter DEFAULT if no other rule applies and datafill refinement RESULT described later in this table. For a DEFAULT rule</p> <ul style="list-style-type: none"> <li>• field RULENO must contain 0 (zero)</li> <li>• be the first rule specified in field REFERENCE</li> <li>• have a result associated with it in field RESULT</li> </ul> <p>Subfields are not specified with the DEFAULT rule type.</p>
	BLOCK	see subfield	<p><i>Block</i>If the entry in subfield RULETYPE is BLOCK, datafill this refinement. This field consists of subfields FROMSI, TOSI, FROMH0, TOH0, FROMH1, and TOH1.</p>
	FROMSI	one vector or \$	<p><i>From service indicators</i>Enter one of the service indicators (SI) representing the start of the range of SIs to which this rule applies. The value in FROMSI must be less than the value in TOSI.</p> <p>If the rule includes all SIs, enter \$ to indicate no SIs are specified in both FROMSI and TOSI.</p>

**C7BLKSIO** (continued)

## Field descriptions (Sheet 3 of 5)

Field	Subfield or refinement	Entry	Explanation and action
	TOSI	one vector or \$	<p><i>To service indicators</i> Enter one of the SIs representing the end of the range of SIs to which this rule applies. The value in TOSI must be greater than the value in FROMSI.</p> <p>If the rule includes all SIs, enter \$ to indicate no SIs are specified in both FROMSI and TOSI.</p>
	FROMH0	0 to 15 or \$	<p><i>From H0</i> Enter one of the values of the H0 code representing the start of the range of H0 codes to which this rule applies. The value in FROMH0 must be less than the value in TOH0.</p> <p>These fields can only be datafilled when the SI of the message is 0, 1, 2, or 4.</p> <p>If the rule includes all values of the H0 code, enter \$ to indicate no H0 code values are specified in both FROMH0 and TOH0.</p>
	TOH0	0 to 15 or \$	<p><i>To H0</i> Enter one of the values of the H0 code representing the end of the range of H0 codes to which this rule applies. The value in TOH0 must be greater than the value in FROMH0.</p> <p>These fields can only be datafilled when the SI of the message is 0, 1, 2, or 4.</p> <p>If the rule includes all values of the H0 code, enter \$ to indicate no H0 code values are specified in both FROMH0 and TOH0.</p>
	FROMH1	0 to 15 or \$	<p><i>From H1</i> Enter one of the values of the H1 code representing the start of the range of H1 codes to which this rule applies. The value in FROMH1 must be less than the value in TOH1.</p> <p>These fields can only be datafilled when the SI of the message is 0, 1, 2, or 4.</p> <p>If the rule includes all values of the H1 code, enter \$ to indicate no H1 code values are specified in both FROMH1 and TOH1.</p>

**C7BLKSIO** (continued)

## Field descriptions (Sheet 4 of 5)

Field	Subfield or refinement	Entry	Explanation and action
	TOH1	0 to 15 or \$	<p><i>To H1</i> Enter one of the values of the H1 code representing the end of the range of H1 codes to which this rule applies. The value in TOH1 must be greater than the value in FROMH1.</p> <p>These fields can only be datafilled when the SI of the message is 0, 1, 2, or 4.</p> <p>If the rule includes all values of the H1 code, enter \$ to indicate no H1 code values are specified in both FROMH1 and TOH1.</p>
	RESULT	see subfields	<p><i>Result</i> If the entry in subfield RULETYPE is DEFAULT, datafill this refinement. This field consists of subfields NEXTFN and NEXTREF.</p>
	NEXTFN	C7ALWDPC C7BLKDPC C7DSTFLD or STOP	<p><i>Next screening function</i> Enter the next screening function to be performed.</p> <p>If the entry is STOP, no refinements require datafill.</p> <p>If the entry is any entry other than STOP, datafill refinement NEXTREF.</p>
	NEXTREF	alphanumeric	<p><i>Next screening reference</i> If entry in subfield NEXTFN is other than STOP, enter the value in field REFERNCE of the screening table that was specified in field NEXTFN that designates the next screening function to be performed.</p>
REMARKS		alphanumeric (1 to 8 characters)	<p><i>Remarks</i> This field is specified by the operating company and can be used to identify the name of the network or carrier to which the link is connected. Any eight-character value can be stored in this field. Avoid the use of special characters, such as +, *, /, -, and %.</p>



**C7BLKSIO** (continued)**Field descriptions (Sheet 5 of 5)**

Field	Subfield or refinement	Entry	Explanation and action
OPTIONS		see subfield	<i>Options</i> This field is used to specify CCS7 screening options. It consists of subfield OPTNAME.
	OPTNAME	\$	<i>Option name</i> Enter \$, which is the only valid entry.

**Datafill example**

The following example shows sample datafill for table C7BLKSIO.

**MAP display example for table C7BLKSIO**

SCRNREF	SCRNRULE	REMARKS
OPTIONS		
REF0 0	CCITT7 DEFAULT C7ALWDPC REF0	\$
REF0 1	CCITT7 BLOCK ( 0)\$ ( 2)\$ ( 0)\$ ( 15)\$ ( 0)\$ ( 15)\$	\$
REF0 2	CCITT7 BLOCK ( 4)\$ ( 4)\$ ( 0)\$ ( 0)\$ ( 0)\$ ( 0)\$	\$

**Table history****STP04.0**

Removed references to MDR7 screening.

**CSP06**

Information removed about bulk deletion workaround.

**CSP02**

Information added about the possibility of service degradation if gateway screening is not turned off.

## C7BLKSIO (end)

---

### BCS36

Refinement MAXOCTET removed. Information added about bulk deletions.

### Supplementary information

This section provides information on modifying datafill for CCITT in table C7BLKSIO.

#### Datafill modifications



#### **DANGER**

##### **Risk of service degradation**

A service degradation can occur if gateway screening is not turned off in table C7GTWLKS prior to making additions, deletions, or changes to table C7BLKSIO (for CCITT only).

The previous table control warning is displayed at the MAP display if a user attempts to add, change, or delete tuples in table C7BLKSIO.

A similar message is displayed in all the gateway screening tables (C7AFTPC, C7ALWDPC, C7ALWGTT, C7ALWOPC, C7ALWSIO, C7BLKDPC, C7BLKOPC, C7BLKSIO for CCITT only, C7CDPA, C7CGPA, and C7DSTFLD).

**Note:** The VERIFY function must be turned on. If VERIFY is off, the above warning is not displayed.

---

**C7CDPA**

---

**Table name**

CCS7 Gateway STP SCCP Called Party Address Screening Table

**Functional description**

Table C7CDPA screens messages in American National Standards Institute (ANSI) and NTC7 format. It defines the gateway screening functions for the signaling connection control part (SCCP) called party address (CDPA).

*Note:* All references to signaling transfer point (STP) are applicable to the STP/Service Switching Point (SSP) Integrated Nodes (INode), unless otherwise specified.

For related information, refer to table C7GTWLKS.

**Datafill sequence and implications**

Table C7AFTPC (if required) must be datafilled before table C7CDPA.

The following tables (if required) must be datafilled after table C7CDPA:

- C7CGPA
- C7ALWGTT
- C7ALWSIO

**Table size**

0 to 32 767 tuples

Up to 400 tuples

**Table size restrictions**

The limit of 400 tuples for this table depends on the datafill in the other gateway screening tables.

The limit of 32 767 tuples for this table depends on the datafill in the other gateway screening tables. There is a maximum of 32 767 possible screening rules for all gateway tables (except table C7GTWLKS) so the maximum number of tuples for the tables is 32 767 with the following restrictions:

- up to 1024 screening references for all tables
- up to 256 rules for each screening reference

**C7CDPA** (continued)**Datafill**

The following table lists datafill for table C7CDPA.

**Field descriptions (Sheet 1 of 4)**

Field	Subfield or refinement	Entry	Explanation and action
SCRNREF		see subfields	<i>Screening reference</i> This field consists of subfields REFERNCE and RULENO.
	REFERNCE	alphanumeric (1 to 4 characters)	<i>Screening reference</i> Enter a value that uniquely identifies a called party address (CDPA) screening function.
	RULENO	0 to 255	<i>Rule number</i> Enter a number to identify a rule within a screening function. Each screening function consists of up to 256 distinct rules.
SCRNRULE		see subfields	<i>Screening rule</i> This field contains all the screening rule information and consists of subfields NETTYPE, FROMPC, TOPC, FROMSSN, TOSSN, FRSCMGMT, TOSCMGMT, and RESULT.
	NETTYPE	ANSI7 or NTC7	<i>Network type</i> Enter ANSI7 if the point codes screened are in ANSI format. This table is not used for screening messages in the CCITT format.  Enter NTC7 if the point codes screened are in NTC7 format.  Entries outside the range indicated for this field are invalid.
	FROMPC	a vector from 0 to 3 values in the range 0 to 255	<i>From point codes</i> For a NETTYPE of ANSI7, enter a full or partial destination point code (DPC) representing the start of the range of DPCs to which this rule applies. This is specified as a vector of zero to three values in the range 0 to 255. End the vector with a blank space and a \$. The value of subfield FROMPC must be less than or equal to subfield TOPC.  For a NETTYPE of NTC7, enter a full DPC representing the start of the range of DPCs to which the rule applies. The \$ (dollar sign) is not allowed.

**C7CDPA** (continued)

## Field descriptions (Sheet 2 of 4)

Field	Subfield or refinement	Entry	Explanation and action
	TOPC	a vector from 0 to 3 values in the range 0 to 255	<p><i>To point code</i> For a NETTYPE of ANS17, enter a full or partial destination point code representing the end of the range of destination point codes to which this rule applies. This is specified as a vector of zero to three values in the range 0 to 255.</p> <p>The value of subfield TOPC must be greater than or equal to subfield FROMPC.</p> <p>End the vector with a blank space and a \$.</p> <p>For a NETTYPE of NTC7, enter a full DPC representing the end of the range of DPCs to which the rule applies. The \$ (dollar sign) is not allowed.</p>
	FROMSSN	0 to 255 or \$	<p><i>From subsystem number</i> Enter one of the subsystem numbers representing the start of the range of subsystem numbers to which this rule applies.</p> <p>The value in subfield FROMSSN must be less than the value in subfield TOSSN.</p> <p>If the rule includes all subsystem numbers, enter \$ (no subsystem numbers specified) in subfields FROMSSN and TOSSN.</p>
	TOSSN	0 to 255 or \$	<p><i>To subsystem number</i> Enter one of the subsystem numbers representing the end of the range of subsystem numbers to which this rule applies. The value in subfield TOSSN must be greater than the value in subfield FROMSSN.</p> <p>If the rule includes all subsystem numbers, enter \$ (no subsystem numbers specified) in subfields FROMSSN and TOSSN.</p>

**C7CDPA** (continued)

## Field descriptions (Sheet 3 of 4)

Field	Subfield or refinement	Entry	Explanation and action
	FRSCMGMT	0 to 255 or \$	<p><i>From SCCP management message types</i> Enter one of the signaling connection control part (SCCP) management (SCMG) message types representing the start of the range of SCMG message types to which this rule applies.</p> <p>The value in subfield FRSCMGMT must be less than the value in subfield TOSCMGMT.</p> <p>This field is only significant when the subsystem number of the CDPA being screened is 1 (SCMG). If the subsystem number is other than 1, enter \$.</p> <p><b>Note:</b> If the subsystem number is 1, the SCMG format identifier must not be NIL.</p>
	TOSCMGMT	0 to 255 or \$	<p><i>From SCCP management message types</i> Enter one of the SCMG message types representing the end of the range of SCMG message types to which this rule applies. The value in subfield TOSCMGMT must be greater than the value in subfield FRSCMGMT.</p> <p>This field is only significant if the subsystem number of the CDPA being screened is 1 (SCMG). If the subsystem number is other than 1, enter \$.</p>
	RESULT	see subfield	<p><i>Screening result</i> This field consists of subfield NEXTFN.</p>
	NEXTFN	C7AFTPC or STOP	<p><i>Next screening function</i> Enter the next screening function to be performed.</p> <p>If subfield NEXTFN contains an entry other than STOP, and the subsystem number of the message is 1, enter C7AFTPC and datafill refinement NEXTREF.</p> <p>Enter STOP if the subsystem number is not equal to 1. No additional refinements require datafill.</p>

**C7CDPA** (continued)**Field descriptions (Sheet 4 of 4)**

Field	Subfield or refinement	Entry	Explanation and action
	NEXTREF	alphanumeric	<i>Next screening referencelf</i> subfield NEXTFN contains C7AFTPC, enter the value that designates the next screening function to be performed in field REFERNCE of table C7AFTPC.
REMARKS		alphanumeric (1 to 8 characters)	<i>Remarks</i> This field is specified by the operating company and can be used to identify the name of the network or carrier to which the link is connected. Any eight-character value can be stored in this field. Avoid the use of special characters, such as +, *, /, -, and %.
OPTIONS		see subfields	<i>Options</i> This field is used to specify screening options. It consists of subfield OPTNAME.
	OPTNAME	\$	<i>Option name</i> Enter \$, which is the only valid entry.

**Datafill example**

The following example shows sample datafill for table C7CDPA.

For each of the rules, if the screening rule matches the message being screened, then screening is finished and the call is routed normally, otherwise, the call is discarded.

**C7CDPA** (continued)

**MAP display example for table C7CDPA**

SCRNREF	SCRNRULE	REMARKS
OPTIONS		
REF8 0	ANSI7 (245) \$ (245) \$ (1) \$ (1) \$ (1) \$ (255) \$ C7AFTPC	REF9 \$
\$		
REF8 1	ANSI7 (245) \$ (245) \$ (251) \$ (251) \$ \$ \$ STOP	\$
\$		
REF8 2	ANSI7 (5) \$ (5) \$ (251) \$ (251) \$ \$ \$ STOP	\$
\$		
REF8 3	ANSI7 (4) \$ (4) \$ (251) \$ (251) \$ \$ \$ STOP	\$
\$		
REF8 4	ANSI7 (0) \$ (0) \$ (251) \$ (251) \$ \$ \$ STOP	\$
\$		

**Table history**

**STP04.0**

Removed references to MDR7 screening.

**CSP06**

Information removed about bulk deletion workaround.

**CSP02**

Information added about the possibility of service degradation if gateway screening is not turned off.

**BCS36**

Information added about bulk deletions.

**Supplementary information**

This section provides information on datafilling table C7CDPA for specific applications.



---

**C7CDPA** (end)

---

**Datafill modifications****DANGER****Risk of service degradation**

A service degradation can occur if gateway screening is not turned off in table C7GTWLKS prior to making additions, deletions, or changes to table C7CDPA.

The previous table control warning is displayed at the MAP display if a user attempts to add, change, or delete tuples in table C7CDPA.

A similar message is displayed in all the gateway screening tables (C7AFTPC, C7ALWDPC, C7ALWGTT, C7ALWOPC, C7ALWSIO, C7BLKDPC, C7BLKOPC, C7BLKSIO for CCITT only, C7CDPA, C7CGPA, and C7DSTFLD).

*Note:* The VERIFY function must be turned on. If VERIFY is off, the previous warning is not displayed.

## C7CGPA

---

### Table name

CCS7 Gateway STP SCCP Calling Party Address Screening Table

### Functional description

Table C7CGPA defines the gateway screening functions for the signaling connection control part (SCCP) calling party address (CGPA). Each screening function consists of a set of up to 256 individual screening rules. Each screening rule can have a different screening result.

*Note:* All references to signaling transfer point (STP) are applicable to the STP/Service Switching Point (SSP) Integrated Nodes (INode), unless otherwise specified.

For related information, refer to table C7GTWLKS.

### Datafill sequence and implications

The following tables (if required) must be datafilled before table C7CGPA:

- C7ALWGTT
- C7CDPA

The following tables (if required) must be datafilled after table C7CGPA:

- C7ALWDPC
- C7ALWOPC
- C7ALWSIO
- C7BLKDPC
- C7BLKOPC

### Table size

32 767 tuples

Up to 400 tuples

The limit of 400 tuples for this table depends on the datafill in the other gateway screening tables.

The limit of 32 767 tuples for this table depends on the datafill in the other gateway screening tables. There are a maximum of 32 767 possible screening rules for all of the gateway tables (except table C7GTWLKS), therefore, the

**C7CGPA** (continued)

maximum number of tuples for the tables is 32 767 with the following restrictions:

- up to 1024 screening references for all tables
- up to 256 rules for each screening reference

**Datafill**

The following table lists datafill for table C7CGPA.

**Field descriptions (Sheet 1 of 2)**

Field	Subfield or refinement	Entry	Explanation and action
SCRNREF		see subfields	<i>Screening reference</i> This field is the key to the table and consists of subfields REFERNCE and RULENO.
	REFERNCE	alphanumeric (1 to 4 characters)	<i>Screening reference</i> Enter a value that uniquely identifies a calling party address (CGPA) screening function.
	RULENO	0 to 255	<i>Rule number</i> Enter a number to identify a rule in a screening function. Each screening function can consist of up to 256 distinct rules.
SCRNRULE		see subfield	<i>Screening rule</i> This field contains all the screening rule information and consists of subfield NETTYPE.

**C7CGPA** (continued)

## Field descriptions (Sheet 2 of 2)

Field	Subfield or refinement	Entry	Explanation and action
	NETTYPE	ANSI7, CCITT7, or NTC7	<p><i>Network type</i> Enter the network type of the screening rule.</p> <p>Enter ANSI7 if the point codes screened are in American National Standards Institute (ANSI) format. Datafill refinements FROMPC, TOPC, FROMSSN, TOSSN, FRMLKGRP, TOLKGRP, CDPARTG, and RESULT described in the following table..</p> <p>Enter CCITT7 if the point codes screened are in the CCITT format. Datafill refinements PCRANGE, FROMSSN, TOSSN, FRMLKGRP, TOLKGRP, CDPARTG, and RESULT described in the field descriptions table in Section "NETTYPE = CCITY"..</p> <p>Enter NTC7 if the point codes being screened are in NTC7 format. Datafill refinements FROMPC, TOPC, FROMSSN, TOSSN, FRMLKGRP, TOLKGRP, CDPARTG, and RESULT described in the following table..</p> <p><b>Note:</b> All screening functions defined prior to the BCS30 release of this table are ANSI format.</p>

**NETTYPE = ANSI7 and NTC7**

If the entry in subfield NETTYPE is ANSI7 or NTC7, datafill refinements FROMPC and TOPC as described below, then datafill refinements FROMSSN, TOSSN, FRMLKGRP, TOLKGRP, CDPARTG, and RESULT described in the field descriptions table in Section "NETTYPE = ANSI7, CCITY and NTC7"..

**C7CGPA** (continued)**Field descriptions for conditional datafill**

Field	Subfield or refinement	Entry	Explanation and action
	FROMPC	0 to 255	<p><i>From point code</i> For a NETTYPE of ANSI7, enter a full or partial originating point code (OPC) representing the start of the range of OPCs to which this rule applies. Up to three values can be datafilled. If less than three values are required, end the list with a \$.</p> <p>For a NETTYPE of NTC7, enter a full OPC representing the start of the range of OPCs to which the rule applies. The \$ (dollar sign) is not allowed.</p> <p>The value of field FROMPC must be less than or equal to the value in field TOPC.</p>
	TOPC	0 to 255	<p><i>To point code</i> For a NETTYPE of ANSI7, enter a full or partial OPC representing the end of the range of OPCs to which this rule applies. Up to three values can be datafilled. If less than three values are required, end the list with a blank column and a \$.</p> <p>For a NETTYPE of NTC7, enter a full OPC representing the end of the range of OPCs to which the rule applies. The \$ (dollar sign) is not allowed.</p> <p>The value of field TOPC must be greater than or equal to the value in field FROMPC.</p>

**NETTYPE = CCITT7**

If the entry in subfield NETTYPE is CCITT7, datafill refinement PCRANGE as described in the following table, then datafill refinements FROMSSN, TOSSN, FRMLKGRP, TOLKGRP, CDPARTG, and RESULT described in the field descriptions table in Section “NETTYPE = ANSI7, CCITTY and NTC7..

**C7CGPA** (continued)**Field descriptions for conditional datafill (Sheet 1 of 2)**

<b>Field</b>	<b>Subfield or refinement</b>	<b>Entry</b>	<b>Explanation and action</b>
	PCRANGE	see subfield	<i>CCITT point code range</i> This field consists of subfield FORMAT.
	FORMAT	BASIC or INTL	<i>Format of CCITT point codes</i> If the point code used is international, enter INTL and its refinements.  If the point code used is based on one field, enter BASIC and its refinements.
	FROMPC	0 to 16383 or see subfields	<i>From point code</i> If the entry in subfield FORMAT is BASIC, enter a full originating point code (OPC) representing the start of the range of OPCs to which this rule applies.  If the entry in subfield FORMAT is INTL, this field consists of subfields FROMZONE, FROMAREA, and FRMPOINT. Separate each subfield with a single space.  The value of field FROMPC must be less than or equal to the value in field TOPC.
	FROMZONE	0 to 7	<i>From zone</i> Enter a value in the field FROMZONE for the OPC to which this rule applies.
	FROMAREA	0 to 255	<i>From area</i> Enter a value in the field FROMAREA for the OPC to which this rule applies.
	FRMPOINT	0 to 7	<i>From point</i> Enter a value in the field FRMPOINT for the OPC to which this rule applies.
	TOPC	see subfields	<i>To point code</i> This field consists of subfields TOZONE, TOAREA, and TOPOINT. Separate each subfield with a single space.  The value of field TOPC must be greater than or equal to the value in field FROMPC.
	TOZONE	0 to 7	<i>To zone</i> Enter a value in the field TOZONE for the OPC to which this rule applies.

**C7CGPA** (continued)**Field descriptions for conditional datafill (Sheet 2 of 2)**

Field	Subfield or refinement	Entry	Explanation and action
	TOAREA	0 to 255	<i>To area</i> Enter a value in the field TOAREA for the OPC to which this rule applies.
	TOPOINT	0 to 7	<i>To point</i> Enter a value in the field TOPOINT for the OPC to which this rule applies.

**NETTYPE = ANSI7, CCITT7 and NTC7**

For all network types, continue datafill with refinements FROMSSN, TOSSN, FRMLKGRP, TOLKGRP, CDPARTG, and RESULT as described in the following table.

**Field descriptions (Sheet 1 of 3)**

Field	Subfield or refinement	Entry	Explanation and action
	FROMSSN	0 to 255 or \$	<p><i>From subsystem number</i> Enter one of the subsystem numbers representing the start of the range of subsystem numbers to which this rule applies.</p> <p>The value in field FROMSSN must be less than the value in field TOSSN.</p> <p>If the rule includes all subsystem numbers, enter \$ (no subsystem numbers specified, a vector with no elements) in fields FROMSSN and TOSSN.</p>
	TOSSN	0 to 255 or \$	<p><i>To subsystem number</i> Enter one of the subsystem numbers representing the end of the range of subsystem numbers to which this rule applies.</p> <p>The value in field TOSSN must be greater than the value in field FROMSSN.</p> <p>If the rule includes all subsystem numbers, enter \$ (no subsystem numbers specified, a vector with no elements) in fields FROMSSN and TOSSN.</p>
	FROMMT	0 to 255 or \$	Entering datafill into subfield FROMMT does not affect system functionality in this software release.

**C7CGPA** (continued)

## Field descriptions (Sheet 2 of 3)

Field	Subfield or refinement	Entry	Explanation and action
	TOMT	0 to 255 or \$	Entering datafill into subfield TOMT does not affect system functionality in this software release.
	FRMLKGRP	0 to 99 or \$	<p><i>From link group</i> Enter one of the link groups, representing the start of the range of link groups to which this rule applies. One of the values in the range, determined by fields FRMLKGRP and TOLKGRP, is datafilled field LINKGRP in table C7GTWLKS.</p> <p>The value in field FRMLKGRP must be less than the value in subfield TOLKGRP.</p> <p>If the rule includes all link groups, enter \$ (no subsystem numbers specified, a vector with no elements) in fields FRMLKGRP and TOLKGRP.</p>
	TOLKGRP	0 to 99 or \$	<p><i>To link group</i> Enter one of the link groups representing the end of the range of link groups to which this rule applies. One of the values in the range, determined by subfields FRMLKGRP and TOLKGRP, is datafilled in table C7GTWLKS, field LINKGRP.</p> <p>The value in field TOLKGRP must be greater than the value in field FRMLKGRP.</p> <p>If the rule includes all subsystem numbers, enter \$ (no subsystem numbers specified, a vector with no elements) in fields FROMSSN and TOSSN.</p>
	CDPARTG	RTALLRTGT orRTSS	<p><i>Called party address routing indicator</i> Enter one of the symbols representing the value of the called party address (CDPA) routing indicator for which this rule applies.</p> <p>RTALL means this rule applies to both routing indicators 0 and 1</p> <p>RTGT represents a routing indicator of 0 (route on a global title)</p> <p>RTSS represents a routing indicator of 1 (route on point code and subsystem number)</p>



**C7CGPA** (continued)

## Field descriptions (Sheet 3 of 3)

Field	Subfield or refinement	Entry	Explanation and action
	RESULT	see subfield	<i>Screening result</i> This field is a two-part field. It specifies the next screening function invoked for messages that follow this rule. This field consists of subfield NEXTFN.
	NEXTFN	C7ALWGTT C7DPAORST OP	<i>Next screening function</i> Enter the next screening function to be performed.  An entry of C7ALWGTT can only be specified if subfield CDPARTG contains RTGT.  An entry of C7ALWGTT cannot be specified if subfield CDPARTG contains RTSS or RTALL.  If the entry in subfield NEXTFN contains STOP, no additional refinements require datafill.  If the entry in subfield NEXTFN contains any entry other than STOP, datafill refinement NEXTREF.
	NEXTREF	alphanumeric (1 to 4 characters)	<i>Next screening reference</i> If the entry in subfield NEXTFN is C7ALWGTT or C7DPA, enter the value in field REFERENCE of the screening table that was specified in subfield NEXTFN that designates the next screening function performed.
REMARKS		alphanumeric (1 to 8 characters)	<i>Remarks</i> This field is specified by the operating company and can be used to identify the name of the network or carrier to which the link is connected. Avoid the use of special characters, such as +, *, /, -, and %.
OPTIONS		see subfields	<i>Options</i> This field is used to specify CCS7 screening options. This field consists of subfield OPTNAME.
	OPTNAME	\$	<i>Option name</i> Enter \$, which is the only valid entry.

**Datafill example**

The following example shows sample datafill for table C7CGPA.

**C7CGPA** (continued)

**MAP display example for table C7CGPA**

SCRNREF	SCRNRULE	REMARKS
OPTIONS		
REF6 0	ANSI7 (250) \$ (250) \$ (253) \$ (253) \$ (9) \$ (18) \$ (0) \$ (0) \$	
	RTGT C7ALWGTT REF7	\$
		\$
REF6 1	ANSI7 (252) \$ (252) \$ (253) \$ (253) \$ (9) \$ (18) \$ (0) \$ (0) \$	
	RTGT C7ALWGTT REF7	\$
		\$
REF6 2	ANSI7 (247) \$ (247) \$ (253) \$ (253) \$ (9) \$ (18) \$ (0) \$ (0) \$	
	RTGT C7ALWGTT REF7	\$
		\$
REF6 3	ANSI7 (251) \$ (251) \$ (253) \$ (253) \$ (9) \$ (18) \$ (0) \$ (0) \$	
	RTGT C7ALWGTT REF7	\$
		\$
REF6 4	ANSI7 (249) \$ (249) \$ (253) \$ (253) \$ (9) \$ (18) \$ (0) \$ (0) \$	
	RTGT C7ALWGTT REF7	\$
		\$

**Table history**

**STP4.0**

Added fields FROMMT and TOMT.

Removed references to MDR7 screening.

**CSP06**

Information removed about bulk deletion workaround.

**CSP02**

Information added about the possibility of service degradation if gateway screening is not turned off.

**BCS36**

Refinement MAXOCTET removed. Information added about bulk deletions.

**Supplementary information**

This section provides information on modifying datafill in table C7CGPA.

**Datafill modifications****DANGER****Risk of service degradation**

A service degradation can occur if gateway screening is not turned off in table C7GTWLKS prior to making additions, deletions, or changes to table C7CGPA.

The previous table control warning is displayed at the MAP display if a user attempts to add, change, or delete tuples in table C7CGPA.

A similar message is displayed in all the gateway screening tables (C7AFTPC, C7ALWDPC, C7ALWGTT, C7ALWOPC, C7ALWSIO, C7BLKDPC, C7BLKOPC, C7BLKSIO for CCITT only, C7CDPA, C7CGPA, and C7DSTFLD).

**Note:** The VERIFY function must be turned on. If VERIFY is off, the above warning is not displayed.

## C7CNGSTN

---

### Table name

Common Channel Signaling 7 Congestion Threshold Table

### Functional description

Table C7CNGSTN provides a number of sets of congestion threshold values. A set of default values, used to select thresholds for use on the signaling links in the linkset, is added to the table at loadbuild. Routeset management reacts to congestion levels whenever thresholds are crossed.

One of two sets of default values is loaded into this table, depending on whether the network served is inside or outside North America (international).

Table C7CNGSTN provides a number of sets of threshold values for three congestion levels. Each threshold level has three values: one for congestion onset, one for congestion abatement, and one for congestion discard. Each set of congestion levels consists of nine values. North American networks use all three levels of congestion. International networks with a network indicator of national and Australian national and international networks only use one level of congestion. One-level congestion networks do not need to specify a discard threshold.

### Adding, modifying, and deleting threshold levels

Synchronized links, which select a congestion tuple that was added or modified, must be deactivated and activated again in order for the new congestion values to take effect.

#### Adding threshold levels

Select a previously undefined index. If the multiple congestion status (MCS [field MCS]) selected equals 3, nine threshold values for the network must be entered. If the MCS selected equals 1, two threshold values must be entered.

The rules for datafilling the nine values of the three levels congestion are summarized below. An illustration of these rules is presented in the following figure on the next page.

- The congestion abatement threshold must be less than the corresponding congestion onset threshold.
- The congestion abatement threshold  $n$  ( $n = 2, 3$ ) must be greater than congestion onset threshold  $n - 1$ .
- The congestion discard threshold  $n$  ( $n = 1, 2, 3$ ) must be greater than congestion onset threshold  $n$ .

**C7CNGSTN** (continued)

- The congestion discard threshold  $n$  ( $n = 1, 2$ ) must be less than or equal to the congestion onset threshold  $n + 1$ .
- The congestion discard threshold  $n$  ( $n = 1, 2$ ) must be less than or equal to the congestion abatement threshold  $n + 1$ .

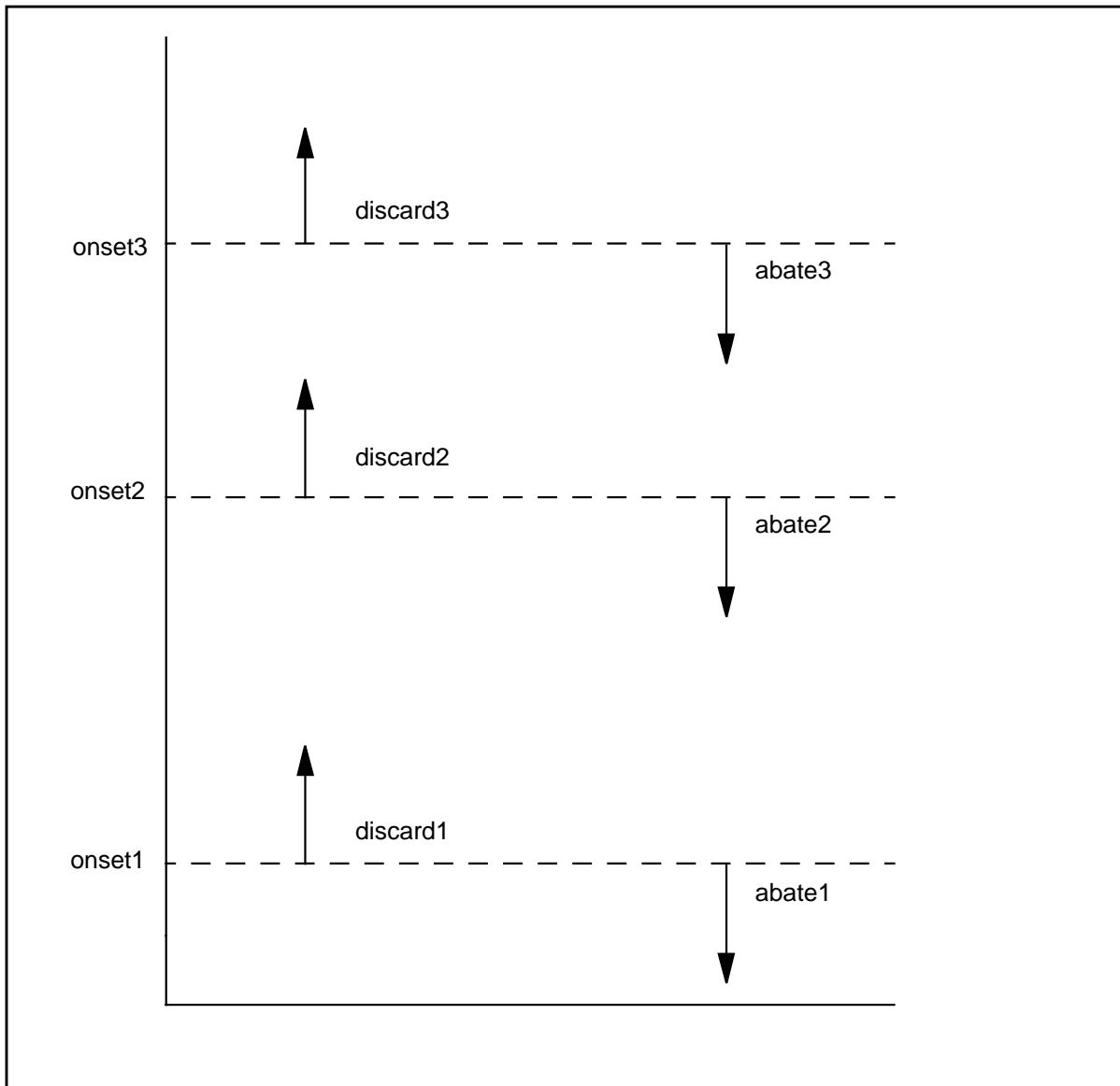
**Commissioning rules for thresholds from the American National Standards Institute (ANSI) T1X1 Q.704 Section 3.6.2**

For one level congestion status networks, datafill the two values that correspond to onset and abatement thresholds in the fields called ONSET and ABATE respectively.

**C7CNGSTN** (continued)**Modifying threshold values**

Threshold values can be modified without taking the referencing linksets offline.

**Deleting threshold values**

All linksets that have selected a particular set of thresholds must first be modified to select another set. Delete the set keyed by its index number in the table.

**Default congestion values**

A set of congestion values for a three-level congestion network is added to the first tuple of the congestion threshold table at loadbuild. For networks using non-ANSI types of Common Channel Signaling 7 (CCS7) signaling, a set of congestion values for a one-level network is added into the second tuple of the table at loadbuild.

All linksets initially use these tuples as default. The set of default congestion values for the network is shown in table Table , "xxDefault congestion values" on page -244. Buffering capacity is measured as a percentage of transmission and retransmission buffering space used in a signaling terminal.

**xxDefault congestion values**

Field name	Default value (in buffering capacity used)
ONSET	63%
ABATE	56%
ONSET1	38%
ABATE1	31%
DISCARD1	44%
ONSET2	63%
ABATE2	56%
DISCARD2	69%
ONSET3	88%
ABATE3	81%
DISCARD3	94%

**C7CNGSTN** (continued)

Tuple index 2 contains the default congestion values for linksets containing high-speed links. Table 2 shows the default datafill for tuple index 2.

**Default congestion values for tuple index 2**

Field name	Default value (in buffering capacity used)
ONSET1	17%
ABATE1	14%
DISCARD1	44%
ONSET2	49%
ABATE2	46%
DISCARD2	76%
ONSET3	82%
ABATE3	79%
DISCARD3	92%

If datafill exists in tuple index 2 prior to the one-night process (ONP) cutover to the new software load, the default values will not override the existing datafill. If tuple index 2 contains datafill prior to the ONP cutover, manually datafill an alternate index with the default datafill.

**Datafill sequence and implications**

There is no requirement to datafill other tables prior to table C7CNGSTN.

**Table size**

0 to 64 tuples

**C7CNGSTN** (continued)**Datafill**

The following table lists datafill for table C7CNGSTN.

**Field descriptions (Sheet 1 of 6)**

Field	Subfield or refinement	Entry	Explanation and action
CONGIDX		0 to 63	<p><i>Congestion table index</i></p> <p>Enter a congestion table index number from 2 to 63.</p> <p>The default value for a three-level network at loadbuild time is 0 (zero).</p> <p>The default value for a one-level network is 1.</p>
CONGEST		see subfield	<p><i>Congestion values</i></p> <p>This field consists of subfield MCS.</p>
	MCS	1 or 3	<p><i>Multiple congestion status</i></p> <p>Enter the number of congestion levels.</p> <p>Enter 3 for North American networks and datafill refinements ONSET and ABATE.</p> <p>Enter 1 for international networks with a network indicator of national and the Australian national and international networks and datafill refinements ONSET1, ABATE1, DISCARD1, ONSET2, ABATE2, DISCARD2, ONSET3, ABATE3, and DISCARD3.</p>
	ONSET	0 to 100	<p><i>Congestion onset threshold</i></p> <p>If the entry in subfield MCS is 1, enter the congestion onset threshold expressed as a percentage of buffer space.</p> <p>Log report CCS173, with congestion level equal to ONSET1, is output if the percentage of buffer space occupied increases to this value from a value less than the congestion abatement threshold value.</p> <p>The value in refinement ONSET must be greater than the value in refinement ABATE.</p>



**C7CNGSTN** (continued)

## Field descriptions (Sheet 2 of 6)

Field	Subfield or refinement	Entry	Explanation and action
	ABATE	0 to 100	<p><i>Congestion abatement threshold</i></p> <p>If the entry in subfield MCS is 1, enter the congestion abatement threshold expressed as a percentage of buffer space.</p> <p>Log report CCS173, with congestion level equal to NONE, is output if the percentage of buffer space occupied decreases to this value after having exceeded the congestion onset threshold value.</p> <p>The value in refinement ABATE must be less than the value in refinement ONSET.</p> <p>No further datafill is required.</p> <p><b>Note:</b> Each value entered in refinements ONSET, ABATE, ONSETn, ABATEn and DISCARDn (n = 1, 2, or 3) is expressed as a percentage of the total buffer capacity available for the transmission of CCS7 messages from the CCITT level 2 (not congestion level 2) to CCITT level 3 (not congestion level 3). In the DMS service switching point (SSP), the buffer capacity is 4096 bytes. The congestion level being datafilled then refers to the amount of this buffer space occupied for messaging, independent of the message length.</p>
	ONSET1	0 to 100	<p><i>Congestion onset threshold level one</i></p> <p>If the entry in subfield MCS is 3, enter the congestion onset threshold level one, expressed as a percentage of buffer space.</p> <p>Log report CCS173, with congestion level equal to ONSET1, is output if the percentage of buffer space occupied increases to this value from below the congestion abatement threshold level one value. The value in refinement ONSET1 must be greater than the value in refinement ABATE1.</p> <p>The value in refinement DISCARD1 must be greater than the value in refinement ONSET1 and must be less than the value in refinement ONSET2.</p>

**C7CNGSTN** (continued)

## Field descriptions (Sheet 3 of 6)

Field	Subfield or refinement	Entry	Explanation and action
	ABATE1	0 to 100	<p><i>Congestion abatement threshold level one</i></p> <p>If the entry in subfield MCS is 3, enter the congestion abatement threshold level one, expressed as a percentage of buffer space.</p> <p>Log report CCS173, with congestion level equal to NONE, is output if the percentage of buffer space occupied decreases to this value after having exceeded the congestion onset threshold level one value.</p> <p>The value in refinement ABATE1 must be less than the value in refinement ONSET1.</p>
	DISCARD1	0 to 100	<p><i>Congestion discard threshold level one</i></p> <p>If the entry in subfield MCS is 3, enter the congestion discard threshold level one, expressed as a percentage of buffer space.</p> <p>Log report CCS173, with congestion level equal to DISCARD1, is output and all messages with priority 0 (zero) are discarded if the percentage of buffer space occupied increases to this value from the congestion onset threshold level one value.</p> <p>The value in refinement DISCARD1 must be greater than the value in refinement ONSET1 and must be less than the value in refinement ONSET2.</p>

**C7CNGSTN** (continued)

## Field descriptions (Sheet 4 of 6)

Field	Subfield or refinement	Entry	Explanation and action
	ONSET2	0 to 100	<p><i>Congestion onset threshold level two</i></p> <p>If the entry in subfield MCS is 3, enter the congestion onset threshold level two, expressed as a percentage of buffer space.</p> <p>Log report CCS173, with congestion level equal to ONSET2, is output if the percentage of buffer space occupied increases to this value from below the congestion abatement threshold level two value.</p> <p>The value in refinement ONSET2 must be greater than the value in refinement ABATE2.</p> <p>The value in refinement DISCARD1 must be greater than the value in refinement ONSET1 and must be less than the value in refinement ONSET2.</p> <p>The value in refinement DISCARD2 must be greater than the value in refinement ONSET2 and must be less than the value in refinement ONSET3.</p>
	ABATE2	0 to 100	<p><i>Congestion abatement threshold level two</i></p> <p>If the entry in subfield MCS is 3, enter the congestion abatement threshold level two, expressed as a percentage of buffer space.</p> <p>Log report CCS173, with congestion level equal to DISCARD1, is output if the percentage of buffer space occupied decreases to this value after having exceeded the congestion onset threshold level two value.</p> <p>The value in refinement ABATE2 must be less than the value in refinement ONSET2.</p>

**C7CNGSTN** (continued)

## Field descriptions (Sheet 5 of 6)

Field	Subfield or refinement	Entry	Explanation and action
	DISCARD2	0 to 100	<p><i>Congestion discard threshold level two</i></p> <p>If the entry in subfield MCS is 3, enter the congestion discard threshold level two, expressed as a percentage of buffer space.</p> <p>Log report CCS173, with congestion level equal to DISCARD2, is output and all messages with priorities 0 (zero) and 1 are discarded, if the percentage of buffer space occupied increases to this value, from the congestion onset threshold level two value.</p> <p>The value in refinement DISCARD2 must be greater than the value in refinement ONSET2 and must be less than the value in refinement ONSET3.</p>
	ONSET3	0 to 100	<p><i>Congestion onset threshold level three</i></p> <p>If the entry in subfield MCS is 3, enter the congestion onset threshold level three, expressed as a percentage of buffer space.</p> <p>Log report CCS173, with congestion level equal to ONSET3, is output if the percentage of buffer space occupied increases to this value from below the congestion abatement threshold level three value.</p> <p>The value in refinement ONSET3 must be greater than the value in refinement ABATE3.</p> <p>The value in refinement DISCARD2 must be greater than the value in refinement ONSET2 and must be less than the value in refinement ONSET3.</p> <p>The value in refinement DISCARD3 must be greater than the value in refinement ONSET3.</p>

**C7CNGSTN** (continued)**Field descriptions (Sheet 6 of 6)**

<b>Field</b>	<b>Subfield or refinement</b>	<b>Entry</b>	<b>Explanation and action</b>
	ABATE3	0 to 100	<p><i>Congestion abatement threshold level three</i></p> <p>If the entry in subfield MCS is 3, enter the congestion abatement threshold level three, expressed as a percentage of buffer space.</p> <p>Log report CCS173, with congestion level equal to DISCARD2, is output if the percentage of buffer space occupied decreases to this value after having exceeded the congestion onset threshold level three value.</p> <p>The value in refinement ABATE3 must be less than the value in refinement ONSET3.</p>
	DISCARD3	0 to 100	<p><i>Congestion discard threshold level three</i></p> <p>If the entry in subfield MCS is 3, enter the congestion discard threshold level three, expressed as a percentage of buffer space.</p> <p>Log report CCS173, with congestion level equal to DISCARD3, is output and all messages with priorities 0 (zero), 1, and 2 are discarded, if the percentage of buffer space occupied increases to this value, from the congestion onset threshold level three value.</p> <p>The value in refinement DISCARD3 must be greater than the value in refinement ONSET3.</p>

**Datafill example**

The following example shows the datafill for table C7CNGSTN.

The example contains three tuples. The first tuple shows the multiple congestion status of 3. The second tuple shows the multiple congestion status of 1. The third tuple is the default congestion tuple for linksets containing high-speed links.

**C7CNGSTN** (end)

---

**MAP display example for table C7CNGSTN**

CONGIDX		CONGEST								
0	3	38	31	44	63	56	69	88	81	94
1								1	63	56
2	3	17	14	44	49	46	76	82	79	92

---

**C7DCIS6**

---

**Table name**

CCS7 STP Global Title Translation of DCIS6 Messages Table

**Functional description**

Table C7DCIS6 contains the address translations for the DMS Common Channel Signaling 7 (CCS7) Destination Common Channel Interface System 6 (DCIS6) messages. Another name for these translations is global title translations (GTT).

The DCIS6 can handle a Common Channel Interface System 6 (CCIS6) direct signaling message at the DMS CCS7 signaling transfer point (STP). The DCIS6 handles this message when an interworking unit embeds the CCIS6 message in a CCS7 signaling connection control part (SCCP) message. The subscriber supplies the interworking unit.

This table extends the current CCS7 STP SCCP abilities to include translation of DCIS6 addresses to CCS7 addresses. The CCS7 STP SCCP includes routing of DCIS6 messages to the destinations.

This table is optional for the DMS CCS7 STPs only. This table does not include the design of DCIS6 functionality or interworking unit for the following points:

- service control point (SCP)
- action point (ACP)
- service switching point (SSP)
- network control point (NCP)

This table handles DCIS6 messages that follow the CCS7 SCCP connectionless unit data message format. These messages must have the CCIS6 message coded in the SCCP message user data part. One CCS7 SCCP message must contain the whole CCIS6 direct signaling message.

This table translates DCIS6 message addresses that fall in the CCIS6 Domains of 0 and 3. Translations that the table performs, cause a CCS7 point code, or a CCS7 point code and SCCP subsystem number group.

**Address translations**

Table C7DCIS6 supports two address translation types:

- CCIS6 Domain 0
- CCIS6 Domain 3

**C7DCIS6** (continued)

The table translates each of these types to one of four results:

- a CCS7 point code
- a CCS7 point code and SCCP subsystem number
- a load shared pair of CCS7 point code and subsystem numbers
- a load shared pair of CCS7 point codes

The table translates the CCIS6 15 bit function number for Domain 0.

The table translates the NPA-NXX of the originating number for Domain 3. Another name for the NPA-NXX is the originating automatic number identification (ANI).

**Message path that DCIS6 messages take**

The message path that the six supported DCIS6 messages take appears in the following figure. The six supported DCIS6 messages are SQRV, SQRV2, SBIL, RDY, SETY, and RTE.

**Message path that DCIS6 messages take**

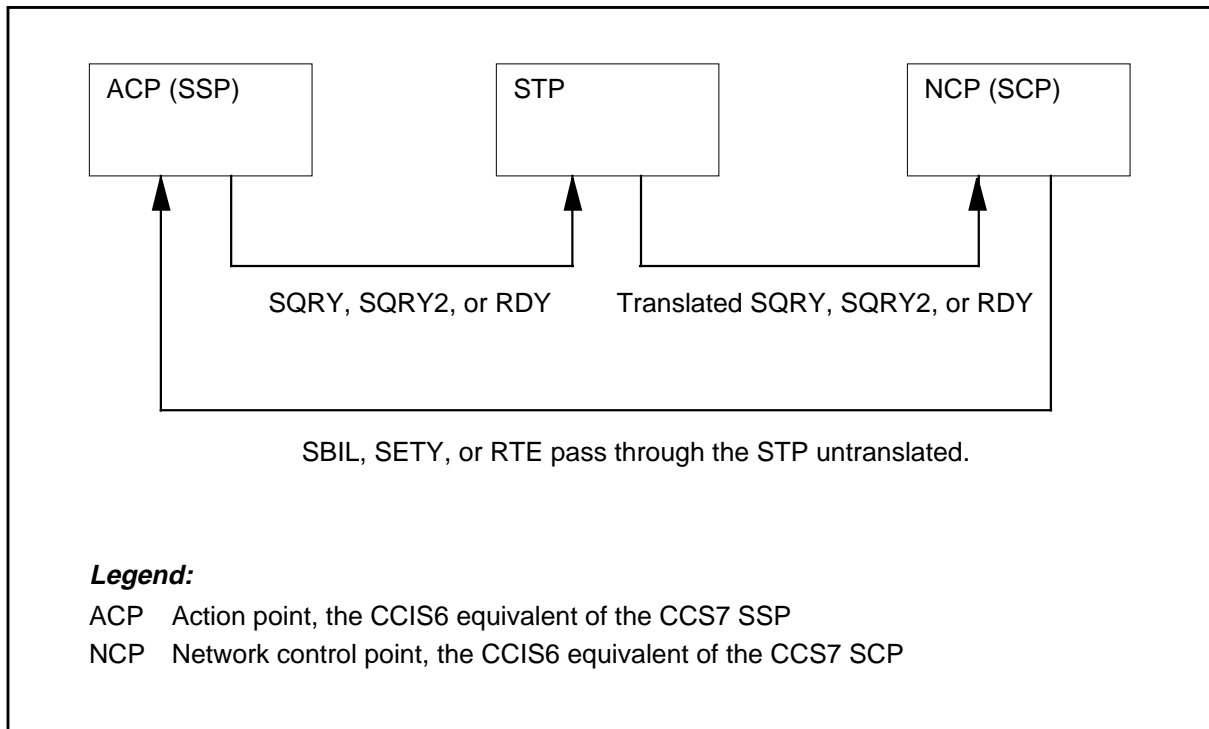



**C7DCIS6** (continued)**Interactions**

If table C7DCIS6 contains the CCS7 Gateway STP Screening tables, the translation type screening does not occur on DCIS6 messages. The DCIS6 messages do not have a translation type in the SCCP called party address.

**Datafill sequence and meaning**

You must enter data in the following tables before you enter data in table C7DCIS6:

- C7RTESET
- C7NETSSN
- C7RPLSSN

**Table size**

A maximum of 256 tuples. The table can contain a maximum of 128 translation tuples of type DOMAIN 0.

**Datafill**

The datafill for table C7DCIS6 appears in the following table.

**Field descriptions (Sheet 1 of 3)**

Field	Subfield or refinement	Entry	Explanation and action
GTTKEY		see subfield	<i>Global title translation key.</i> This field contains subfield DOMAIN.
	DOMAIN	DOMAIN0 or DOMAIN3	<i>Domain.</i> If the domain to translate is DOMAIN 0, enter DOMAIN0 and the datafill refinement FUNCTION.  If the domain to translate is DOMAIN 3, enter DOMAIN3 and datafill refinements FROMDIG and TODIG.
	FROMDIG	vector of a maximum of 6 digits	<i>From digits.</i> Enter a vector of a maximum of 6 digits.
	TODIG	vector of a maximum of 6 digits	<i>To digits.</i> Enter a vector of a maximum of 6 digits.
RESULTS		see subfield	<i>Translation results.</i> This field is a vector that contains subfield RESULT and refinements. Enter \$ to indicate the end of the vector.

**C7DCIS6** (continued)

**Field descriptions (Sheet 2 of 3)**

Field	Subfield or refinement	Entry	Explanation and action
	RESULT	ERROR PCONLY or PCSSN	<p><i>Translation result type.</i> Enter the format of the result. The format is ERROR, PCONLY, or PCSSN (PC and SSN).</p> <p>If the field specifies ERROR, do not enter additional refinements.</p> <p>If the field specifies PCONLY, enter refinements PCNAME and COST. If the field specifies PCONLY, you can specify one or two point codes (PC). You must assign a cost to each PC. The COSTs must be the same for both PCs. Only load sharing can occur between PCs.</p> <p>If the field specifies PCSSN, one or two results can occur. Table C7NETSSN must define both network subsystem names. If two results occur, table C7RPLSSN must define the results as replicates. Each PCSSN must have an associated COST. If the COSTs are different, the result with the least COST is the primary subsystem. The other result is the auxiliary subsystem. All messages route to the primary subsystem. If the primary subsystem fails, the messages route to the backup subsystem. If one result occurs, backup routing does not occur. This type of routing also occurs if table C7RPLSSN replicates the subsystem.</p>
	PCNAME	alphanumeric (1 to 16 characters)	<p><i>Point code name.</i> If the entry in field RESULT is PCONLY, enter one or two point code names with the COST. These PCs must be in table C7NETSSN. If the table specifies two PCs, these PCS are load sharing replicates for the translation.</p> <p>If the entry in field RESULT is PCSSN, enter one of two point code names. Enter these names with the SSNAME and COST.</p>

**C7DCIS6** (continued)**Field descriptions (Sheet 3 of 3)**

Field	Subfield or refinement	Entry	Explanation and action
	SSNAME	alphanumeric	<i>Subsystem name.</i> If the entry in field RESULT is PCSSN, enter one or two subsystem names with the PCNAME. Enter both network subsystem names in table C7NETSSN. If two subsystem names are available, enter these names in table C7RPLSSN.
	COST	0 to 99	<p><i>Cost.</i> Enter a value between 0 and 99. This value specifies a routing preference. A unit of COST is not available. If a GTT has two results, the GTT with the least cost is the preferred route. If two results have the same cost, a preferred route is not available and traffic is load shared.</p> <p>The entry in field RESULT can be PCONLY or PCNEWGT and two items can be in the vector. When this event occurs, the entry in field COST must be the same.</p> <p>The entry in field RESULT can be PCSSN and two items can be in the vector. When this event occurs, the entry in field COST can be different.</p>

**Datafill example**

The original datafill for table C7DCIS6 appears in the following example.

The example contains two tuples. The example contains one tuple for DOMAIN 0 and one tuple for DOMAIN 3.

The tuple for DOMAIN 0 routes the call to a point code and subsystem name with a cost of 0.

The tuple for DOMAIN 3 routes the call to load sharing point codes with the same COST.

**C7DCIS6** (end)

---

**MAP example for table C7DCIS6**

GTTKEY	RESULTS
DOMAIN0 123	PCSSN NEWYORK DCIS6 0 \$
DOMAIN3 0 799	PCONLY NEWYORK 1 EAST39TH 1 \$

**C7DPCTAB****Table name**

The CCS7 Destination Point Code Table

**Functional description**

Table C7DPCTAB is an information base. This table identifies the destination points of Common Channel Signaling 7 (CCS7) message signaling units (MSU) from a DMS-300 Gateway switching office.

The available destination point codes for the DMS-300 office appear in this table. The system can record the volume of MSUs against specified destination nodes. The operating company uses the node volume to plan network traffic.

You must delete and add a tuple again from table C7DPCTAB. Tuple changes cannot occur.

**Datafill sequence and meaning**

You must enter data in table C7NETWRK before you enter data in table C7DPCTAB.

**Table size**

0 to 128 tuples

The system allocates memory for 128 tuples.

**Datafill**

The datafill for table C7DPCTAB appears in the following table.

**Field descriptions (Sheet 1 of 2)**

Field	Subfield or refinement	Entry	Explanation and action
INDEX		1 to 128	<i>Internal CCITT destination point code representation.</i> Enter the index for the destination point code (DPC) to add to the table. This field identifies the CCITT 14-bit point codes in compressed format.
NETNAME		alphanumeric (1 to 16 characters)	<i>Network name.</i> Enter a character string to identify the specified network to which the DPCs correspond.

## C7DPCTAB (continued)

### Field descriptions (Sheet 2 of 2)

Field	Subfield or refinement	Entry	Explanation and action
NETTYPE		CCITT7	<i>Network type.</i> Enter CCITT7 to select the nature of the prompted DPC.
FORMAT		INTL	<i>Point code format.</i> Enter INTL for DMS-300 international point code format.
DPC		see subfields	<i>Destination point code.</i> This field contains subfields ZONE, AREANETW, and SIGPOINT. Each subfield is part of a specified addressing design. This design applies to each signaling destination network. The international FEPC (far end point code) network identification design contains these three parts.
	ZONE	0 to 7	<i>Zone identifier.</i> Enter the zone identifier for the international network.
	AREANETW	0 to 255	<i>Area network identifier.</i> Enter the area network identifier for the international network destination office.
	SIGPOINT	0 to 7	<i>Signal point identifier.</i> Enter the signal point identifier for the international network originating office.

### Datafill example

Sample datafill for table C7DPCTAB appears in the following example.

### MAP example for table C7DPCTAB

INDEX	NETNAME	NETTYPE	FORMAT	DPC
2	C7NETWRK2	CCITT7	INTL	6 241 3

### Additional information

This section provides information on possible error messages when you enter data in table C7DPCTAB.

---

**C7DPCTAB** (end)

---

**Datafill error messages**

You must delete and add a tuple again from table C7DPCTAB. Tuple changes cannot occur. The following error message appears if you attempt to change a tuple:

```
'CHANGES NOT ALLOWED, USE DELETE THEN ADD'
```

If you attempt to add a tuple with the same index as a tuple deleted in the current 24-h period, the following error message appears:

```
'CANNOT ADD TUPLE, MANUAL DIRP ROTATE REQUIRED'
```

To prevent a device independent recording package (DIRP) error message when you change the preceding data, rotate the DIRP. Rotate the DIRP after the next polled upload from the link interface units (LIUs).

## C7DSTFLD

---

### Table name

CCS7 Gateway STP Destination Field Screening Table

### Functional description

Table C7DSTFLD specifies screening functions for the destination field of signaling network management (SNM) messages. This type of screening applies only to messages that have a service indicator (SI) of 0 and with the following message types:

- H0=0100 Transfer Prohibited (TFP, TCP), Transfer Allowed (TFA, TCA) and Transfer Restricted (TFR, TCR) messages
- H0=0101 Routeset Test (RSP, RCP, RSR, RCR) messages
- H0=0011 and H1=0010 Transfer Controlled (TFC) message

Messages that do not meet these criteria are not screened because they do not contain a Destination Point Code (DPC) field and messages are routed normally.

*Note:* All references to signaling transfer point (STP) are applicable to STP/Service Switching Point (SSP) Integrated Nodes (INode), unless otherwise specified.

For related information, refer to table C7GTWLKS.

### Datafill sequence and implications

There is no requirement to datafill other tables prior to table C7DSTFLD.

The following tables (if required) must be datafilled after table C7DSTFLD:

- C7ALWDPC
- C7ALWOPC
- C7ALWSIO
- C7BLKSIO
- C7BLKDPC
- C7BLKOPC

### Table size

32 767 tuples



**C7DSTFLD** (continued)

Up to 2000 tuples

The limit of 2000 tuples for this table depends on the datafill in the other gateway screening tables. There are a maximum of 2000 possible screening rules for all of the gateway tables (except table C7GTWLKS)

- The limit of 32 767 tuples for this table depends on the datafill in the other gateway screening tables. There are a maximum of 32 767 possible screening rules for all of the gateway tables (except table C7GTWLKS), therefore the maximum number of tuples for the tables is 32 767 with the following restrictions:
- up to 1024 screening references for all tables
- up to 256 rules for each screening reference

**Datafill**

The following table lists datafill for table C7DSTFLD.

**Field descriptions (Sheet 1 of 2)**

Field	Subfield or refinement	Entry	Explanation and action
SCRNREF		see subfields	<i>Screening reference</i> This field is the key to the table and consists of subfields REFERNCE and RULENO.
	REFERNCE	alphanumeric (1 to 4 characters)	<i>Screening reference</i> Enter a value that identifies an SNM destination field screening function.
	RULENO	0 to 255	<i>Rule number</i> Enter a number to identify a rule in a screening function. Each screening function can consist of up to 256 distinct rules.

**C7DSTFLD** (continued)

## Field descriptions (Sheet 2 of 2)

Field	Subfield or refinement	Entry	Explanation and action
SCRNRULE		see subfield	<i>Screening rule</i> This field contains all the screening rule information and consists of subfield NETTYPE.
	NETTYPE	ANSI7, CCITT7, or NTC7	<p><i>Network type</i>Enter the network type of the screening rule.</p> <p><i>Network type</i>Enter the network type of the screening rule.</p> <p>Enter ANSI7 if the point codes being screened are in ANSI format. Datafill refinements FROMPC, TOPC, and RESULT described in the following table.</p> <p>Enter CCITT7 if the point codes screened are in the CCITT format. Datafill refinements PCRANGE and RESULT described in the field descriptions table in Section "NETTYPE = CCITT7"..</p> <p>Enter NTC7 if the point codes screened are in the NTC7 format. Datafill refinements FROMPC, TOPC, and RESULT described in the following table..</p> <p><b>Note:</b> Each rule of a screening function must be of the same network type. The network type of a screening function cannot be changed.</p>

**NETTYPE = ANSI7 and NTC7**

If the entry in subfield NETTYPE is ANSI7 or NTC7, datafill refinements FROMPC and TOPC as described in the following table, then datafill refinement RESULT as described in the field descriptions table in Section "NETTYPE = ANSI7, CCITT7 and NTC7"..

**C7DSTFLD** (continued)**Field descriptions for conditional datafill**

Field	Subfield or refinement	Entry	Explanation and action
	FROMPC	0 to 255	<p><i>From point code</i> For a NETTYPE of ANSI7, enter a full or partial DPC representing the start of the range of DPCs to which this rule applies. Up to three values can be datafilled. If less than three values are required, end the list with a \$.</p> <p>For a NETTYPE of NTC7, enter a full Originating Point Code (OPC) representing the start of the range of OPCs to which the rule applies. The \$ (dollar sign) is not allowed.</p> <p>The value of field FROMPC must be less than or equal to the value in field TOPC.</p>
	TOPC	0 to 255	<p><i>To point code</i> For a NETTYPE of ANSI7, enter a full or partial DPC representing the end of the range of DPCs to which this rule applies. Up to three values can be datafilled. If less than three values are required, end the list with a blank column and a \$.</p> <p>For a NETTYPE of NTC7, enter a full OPC representing the end of the range of OPCs to which the rule applies. The \$ (dollar sign) is not allowed.</p> <p>The value of field TOPC must be greater than or equal to the value in field FROMPC.</p>

**NETTYPE = CCITT7**

If the entry in subfield NETTYPE is CCITT7, datafill refinement PCRANGE as described below, then datafill refinement RESULT described in the field descriptions table in Section “NETTYPE = ANSI7, CCITY7 and NTC7”..

**C7DSTFLD** (continued)**Field descriptions for conditional datafill (Sheet 1 of 2)**

<b>Field</b>	<b>Subfield or refinement</b>	<b>Entry</b>	<b>Explanation and action</b>
	PCRANGE	see subfield	<i>CCITT point code range</i> This field consists of subfield FORMAT.
	FORMAT	BASICorINTL	<i>Format of CCITT point codes</i> If the point code used is international, enter INTL and its refinements.  If the point code used is based on one field, enter BASIC and its refinements.
	FROMPC	0 to 16383orsee subfields	<i>From point code</i> If the entry in subfield FORMAT is BASIC, enter a full DPC representing the start of the range of DPCs to which this rule applies.  If the entry in subfield FORMAT is INTL, this field consists of subfields FROMZONE, FROMAREA, and FRMPOINT. Separate each subfield with a single space.  The value of field FROMPC must be less than or equal to the value in field TOPC.
	FROMZONE	0 to 7	<i>From zone</i> Enter a value in the FROMZONE field of the DPC to which this rule applies.
	FROMAREA	0 to 255	<i>From area</i> Enter a value in the FROMAREA field of the DPC to which this rule applies.
	FRMPOINT	0 to 7	<i>From point</i> Enter a value in the FRMPOINT field of the DPC to which this rule applies.
	TOPC	see subfields	<i>To point code</i> This field consists of subfields TOZONE, TOAREA, and TOPOINT. Separate each subfield with a single space.  The value of field TOPC must be greater than or equal to the value in field FROMPC.
	TOZONE	0 to 7	<i>To zone</i> Enter a value in the TOZONE field for the DPC to which this rule applies.

**C7DSTFLD** (continued)**Field descriptions for conditional datafill (Sheet 2 of 2)**

Field	Subfield or refinement	Entry	Explanation and action
	TOAREA	0 to 255	<i>To area</i> Enter a value in the TOAREA field for the DPC to which this rule applies.
	TOPOINT	0 to 7	<i>To point</i> Enter a value in the TOPOINT field for the DPC to which this rule applies.

**NETTYPE = ANSI7, CCITT7, and NTC7**

For all network types, continue datafill with refinement RESULT as described in the following table.

**Field descriptions**

Field	Subfield or refinement	Entry	Explanation and action
	RESULT	see subfields	<i>Screening result</i> This field is a two-part field. It specifies the next screening function invoked for messages that follow this rule. This field consists of subfield NEXTFN.
	NEXTFN	STOP	<i>Next screening function</i> Enter STOP to stop the screening function.
REMARKS		alphanumeric (1 to 8 characters)	<i>Remarks</i> This field is specified by the operating company and can be used to identify the name of the network or carrier to which the link is connected. Avoid the use of special characters, such as +, *, /, -, and %.
OPTIONS		see subfields	<i>Options</i> This field is used to specify CCS7 screening options. This field consists of subfield OPTNAME.
	OPTNAME	\$	<i>Option name</i> Enter \$, which is the only valid entry.

**Datafill example**

The following example shows sample datafill for table C7DSTFLD.

## C7DSTFLD (continued)

### MAP display example for table C7DSTFLD

SCRNREF	OPTIONS	SCRNRULE	REMARKS
REFA 0	ANSI7 (245) ( 1) ( 0)\$ (245) ( 1) ( 0)\$	STOP	\$
\$			
REFA 1	ANSI7 (245) ( 2) ( 0)\$ (245) ( 2) ( 0)\$	STOP	\$
\$			
REFA 2	ANSI7 (245) (206) ( 1)\$ (245) (206) ( 1)\$	STOP	\$
\$			
REFA 3	ANSI7 (245) (206) ( 3)\$ (245) (206) ( 4)\$	STOP	\$
\$			
REFA 4	ANSI7 (245) (215) ( 2)\$ (245) (215) ( 2)\$	STOP	\$
\$			

### Table history

#### STP04.0

Removed references to MDR7 screening.

#### CSP06

Information removed about bulk deletion workaround.

#### CSP02

Information added about the possibility of service degradation if gateway screening is not turned off.

#### BCS36

Information added about bulk deletions.

### Supplementary information

This section provides information on modifying datafill in table C7DSTFLD.

---

**C7DSTFLD** (end)

---

**Datafill modifications****DANGER****Risk of service degradation**

A service degradation can occur if gateway screening is not turned off in table C7GTWLKS prior to making additions, deletions, or changes to table C7DSTFLD.

The previous table control warning is displayed at the MAP display if a user attempts to add, change, or delete tuples in table C7DSTFLD.

A similar message is displayed in all the gateway screening tables (C7AFTPC, C7ALWDPC, C7ALWGTT, C7ALWOPC, C7ALWSIO, C7BLKDPC, C7BLKOPC, C7BLKSIO for CCITT only, C7CDPA, C7CGPA, and C7DSTFLD).

*Note:* The VERIFY function must be turned on. If VERIFY is off, the above warning is not displayed.

## C7GATEPC

---

### Table name

CCS7 Gateway Point Code Table

### Functional description

**ATTENTION**

Feature 59009748 (C7GATEPC/C7GATERS Removal Feature) removes the functionality provided by table C7GATEPC. Table C7GATEPC must be empty.

If you try to create a tuple in table C7GATEPC, the system displays the following error message:

```
*****WARNING*****WARNING*****  
C7GATEPC/C7GATERS (TEL00005) functionality has been replaced.  
Table C7GATEPC is no longer supported in CSP12 or higher.  
Adding new tuple to this table is not allowed.
```

```
*****WARNING*****WARNING*****
```

If you try to perform a table transfer process (TABXFR) during a software upgrade and table C7GATEPC is not empty, the system displays the following error message:

```
*****WARNING*****WARNING*****  
C7GATEPC/C7GATERS (TEL00005) functionality has been replaced.  
Table C7GATEPC is no longer supported in CSP12 or higher.  
Please delete all datafill in Table C7GATEPC before performing  
TABXFR.
```

```
*****WARNING*****WARNING*****
```

If you try to perform a table auditing step (command TABAUDIT) and table C7GATEPC is not empty, the system displays the following error message:

```
*****WARNING*****WARNING*****  
C7GATEPC/C7GATERS (TEL00005) functionality has been replaced.
```



---

**C7GATEPC** (end)

---

Table C7GATEPC is no longer supported in CSP12 or higher.

Please delete all datafill in Table C7GATEPC before upgrading to CSP12 or higher.

\*\*\*\*\*WARNING\*\*\*\*\*WARNING\*\*\*\*\*

## C7GATERS

---

### Table name

CCS7 Gateway Routeset Table

### Functional description

**ATTENTION**

Feature 59009748 (C7GATEPC/C7GATERS Removal Feature) removes the functionality provided by table C7GATERS. Table C7GATERS must be empty.

If you try to create a tuple in table C7GATERS, the system displays the following error message:

```
*****WARNING*****WARNING*****  
C7GATEPC/C7GATERS (TEL00005) functionality has been replaced.  
Table C7GATERS is no longer supported in CSP12 or higher.  
Adding new tuple to this table is not allowed.
```

```
*****WARNING*****WARNING*****
```

If you try to perform a table transfer process (TABXFR) during a software upgrade and table C7GATERS is not empty, the system displays the following error message:

```
*****WARNING*****WARNING*****  
C7GATEPC/C7GATERS (TEL00005) functionality has been replaced.  
Table C7GATERS is no longer supported in CSP12 or higher.  
Please delete all datafill in Table C7GATERS before performing  
TABXFR.
```

```
*****WARNING*****WARNING*****
```

If you try to perform a table auditing step (command TABAUDIT) and table C7GATERS is not empty, the system displays the following error message:

```
*****WARNING*****WARNING*****  
C7GATEPC/C7GATERS (TEL00005) functionality has been replaced.
```

---

**C7GATERS** (end)

---

Table C7GATERS is no longer supported in CSP12 or higher.

Please delete all datafill in Table C7GATERS before upgrading to CSP12 or higher.

\*\*\*\*\*WARNING\*\*\*\*\*WARNING\*\*\*\*\*

## C7GTINT

---

### Table name

CCS7 Global Title International Translation Table

### Functional description

Table C7GTINT is available on gateway switching units (DMS-300) that support the SCCP gateway function.

Table C7GTINT provides translation of international signaling connection control part (SCCP) global titles. The “nature of address” field in the SCCP address format indicates that the address is international. The numbering plan, the country code, and a range of national codes determine the translation. The national codes and country code are optional. Remove these codes from the global title before the message transmits on the SS7 network.

The system supports the following two numbering plans:

- the CCITT E.164, the ISDN numbering plan
- the CCITT E.214, the mobile global title numbering plan

The translation result contains a maximum of two routes. The translation result specifies each route as a point code (PC) or subsystem number (PC/SSN) group. Additional translation can occur at the remote PC. The system transfers the SCCP message to the SS7 network with the “routing indicator” field set to GT. Each route has a cost. The preferred or primary route is the route with the lower cost. The system uses the other route if the primary route is full or fails.

### Datafill sequence and meaning

You must enter data in table C7NETSSN before you enter data in table C7GTINT. If you do not enter data in this sequence, the system does not recognize the entry in the PCNAME field.

### Table size

The system allocates table size. The number of user entries determine the table size. Memory requirements determine the number of user entries.

**C7GTINT** (continued)**Datafill**

Datafill for table C7GTINT appears in the following table.

**Field descriptions (Sheet 1 of 3)**

Field	Subfield or refinement	Entry	Explanation and action
GTIKEY		alphanumeric (see subfields)	<i>Global title international translation key.</i> This key field contains subfields NP, CC, NATCFROM, and NATCTO.
	NP	E164, E214	<i>Numbering plan.</i> Enter E164, if the numbering plan is CCITT E.164, the ISDN numbering plan. Enter E214, if the numbering plan is CCITT E.214. The CCITT E.214 is the mobile global title numbering plan.  This entry allows the two numbering plans to have different translations.
	CC	numeric (1 to 3 digits)	<i>Country code.</i> Enter the country code of the destination.
	NATCFROM	numeric (1 to 8 digits)	<i>From national or network code.</i> Enter a number assigned as the national destination code for an international ISDN number. This number can be the network code of a mobile global title number.  This number can represent a single code or the first in a block of codes in sequence that have the same result.
	NATCTO	numeric (1 to 8 digits)	<i>To national or network code.</i> If the entry in field NATCFROM represents a single code, enter the same single code as in NATCFROM. The entry in field NATCFROM can represent the first code of a block of codes in sequence. When this event occurs, enter the last code in the block.

**C7GTINT** (continued)

## Field descriptions (Sheet 2 of 3)

Field	Subfield or refinement	Entry	Explanation and action
VALID		Y or N	<p><i>Translation supported.</i> Enter Y, if the system supports translation of this address. Enter N if the system does not support this translation. If the translation of the address is not supported, the system generates a UDTs message.</p> <p>If the entry in this field is N, the fields that remain are not required.</p>
	DELCC	Y or N	<p><i>Delete country code.</i> If the entry in field VALID is Y, enter Y. Enter Y if the system must convert the called party address to a national number before translation. If the entry in field VALID is N, leave this field blank.</p>
	RESLIST	alphanumeric (see subfields)	<p><i>Results list.</i> This field is a vector of a maximum of two routing results. This field contains subfields RESTYPE, PCNAME, SSNUM, and COST.</p> <p>If the entry in field VALID is Y, enter data in this field. If the entry is not Y, leave this field blank.</p> <p>This field contains a maximum of two routing results. Associated with each result is COST. The result with the lower COST forms the primary. The result with the higher COST forms the backup. Equal COSTs assume load sharing. Load sharing is not supported.</p>
	RESTYPE	PCONLY or PCSSN	<p><i>Result type.</i> Enter the result type, PCONLY or PCSSN.</p> <p>If the translation results in a destination point code, enter PCONLY. Enter subfields PCNAME and COST.</p> <p>If the translation results in a destination point code and a subsystem number, enter PCSSN. Enter refinements PCNAME, SSNUM, and COST.</p>

**C7GTINT** (continued)**Field descriptions (Sheet 3 of 3)**

Field	Subfield or refinement	Entry	Explanation and action
	PCNAME	alphanumeric	<i>Destination point code name.</i> Enter the destination point code name of the next node to translate the SCCP message. Table C7NETSSN must contain the destination point code name before you enter the name in this subfield.
	SSNUM	1 to 254	<i>Destination subsystem number.</i> If the entry in file RESTYPE is PCSSN, enter the new subsystem number. The called party address contains this subsystem number.  If the entry in file RESTYPE is PCONLY, leave this field blank.
	COST	0 to 99	<i>Relative cost of route.</i> Enter a value between 0 and 99. This value specifies a routing preference. A unit of COST is not available. If two results occur, the result with the lower COST is the primary route. The result with the higher COST is the backup route. The system uses the backup route if the primary route fails. Equal values for COST assume load sharing. The system does not support this option.

**Datafill example**

Sample datafill for table C7GTINT appears in the following example.

The example includes an incoming SCCP message that contains the following information:

- the nature of address = international
- the numbering plan = E214
- the address digits are 46235-----

**C7GTINT** (continued)

The following translation result occurs:

- Delete the country code (46).
- Try to route to D500STP. This route has the lowest cost.
- If the system cannot route to D500STP, the system must route to D400STP. The subsystem number 244 must be in the called party address parameter of the transmitted message.

**MAP example for table C7GTINT**

GTIKEY VALID DELCC						RESLIST
E214	46	234	238	Y	Y	
				PCONLY	D500STP	20
				PCSSN	D400STP	244 40\$

**Additional information**

Information on datafilling table C7GTINT for specified applications appears in this section. This section contains information related to table C7GTINT.

The "Limited SCCP Functionality Using MSB7 on DMS-300" feature provides limited signaling connection control part (SCCP) functionality. An international gateway switch requires this functionality.

The gateway switch allows SCCP messages to cross the international/national network boundary. The SCCP must map the point code (PC) addresses of one network to the PC addresses of the other network.

The gateway transmits international SCCP messages. The gateway switch transmits these messages when the failure of a signaling point in another part of the network causes alternate routing.

The application of a series of global title translations route SCCP messages across the network limit. This method provides access to other networks without the requirement of complete information. Complete information is not a requirement for the configuration of the network and addressing schemes. Global title translation determines the route of an incoming SCCP message. The system flags the message to indicate that the message requires additional global title translation at the next signaling transfer point (STP).



---

**C7GTINT** (continued)

---

**SCCP switching function at a DMS-300 gateway switch**

The SCCP switching function

- receives SCCP messages that the message transfer part (MTP) delivers from the national or international networks.
- examines and translates address information in the Global Title to determine routing for SCCP messages.
- routes the messages to the correct node. Translation determines the correct node.
- amends the information in the Global Title and subsystem number (SSN)
- routes messages around a failed node if another route is available

**Protocol classes at a DMS-300 gateway switch**

The SCCP function supports the following protocol classes:

- Class 0: connectionless, message sequence not guaranteed
- Class 1: connectionless, with message sequencing

*Note:* The SCCP function does not support connection-oriented protocol classes 2 and 3.

**SCCP messages at a DMS-300 gateway switch**

The SCCP function supports the following messages:

**UDT (Unitdata)**

An SCCP uses the UDT to send data in the connectionless mode.

The international gateway does not generate Unitdata messages. When the SCCP receives a Unitdata message, the SCCP analyzes called party information. The SCCP routes the message to the correct node.

**UDTS (Unitdata Service)**

The UDTS indicates to the originating SCCP that delivery of the message sent cannot occur. The option field in the UDT that is not delivered is set to "return on error". This setting allows the SCCP to generate a UDTS message.

The international gateway generates Unitdata service messages if the international gateway cannot deliver a Unitdata message received for onward routing.

## **C7GTINT** (continued)

---

If the SCCP receives messages the SCCP does not recognize, the SCCP discards the messages.

### **SCCP parameters at a DMS-300 gateway switch**

The SCCP function supports the following parameters:

#### **Message type**

This parameter is a one octet parameter. The SCCP function supports message types Unitdata (coded 00001001) and Unitdata Service (coded 00001010).

#### **Protocol class (UDT only)**

This parameter is a one octet parameter. The SCCP function supports protocol classes 0 and 1 with no special options or return message on error.

#### **Return causes (UDTS only)**

This parameter is a one octet parameter. This parameter identifies the reason for the return of user data in Unitdata Service message.

The international gateway generates this parameter if the international gateway cannot route an SCCP message.

A return cause code received in an incoming UDTS message passes clearly.

#### **Called party address**

The called party address is a variable length required parameter.

#### **Calling party address**

The format of this parameter is the same as the format of the called party address.

#### **Data**

This parameter is a variable length field that contains SCCP user data. The maximum message length of 272 octets determines the maximum length of the field. The maximum message length includes the MTP routing label.

All parameters in the UDT and UDTS messages are a requirement. If a parameter is not available, the SCCP function discards the message and generates a maintenance report.

The SCCP function screens parameters and messages to make sure the correct or minimum number of octets is present.

Parameters that the SCCP function does not recognize can be present. The SCCP ignores the parameters and attempts to route the message.

**C7GTINT** (continued)**Format of called and calling party address**

The format of both calling and called party numbers is the same.

The format of the called party address parameter appears in the following figure.

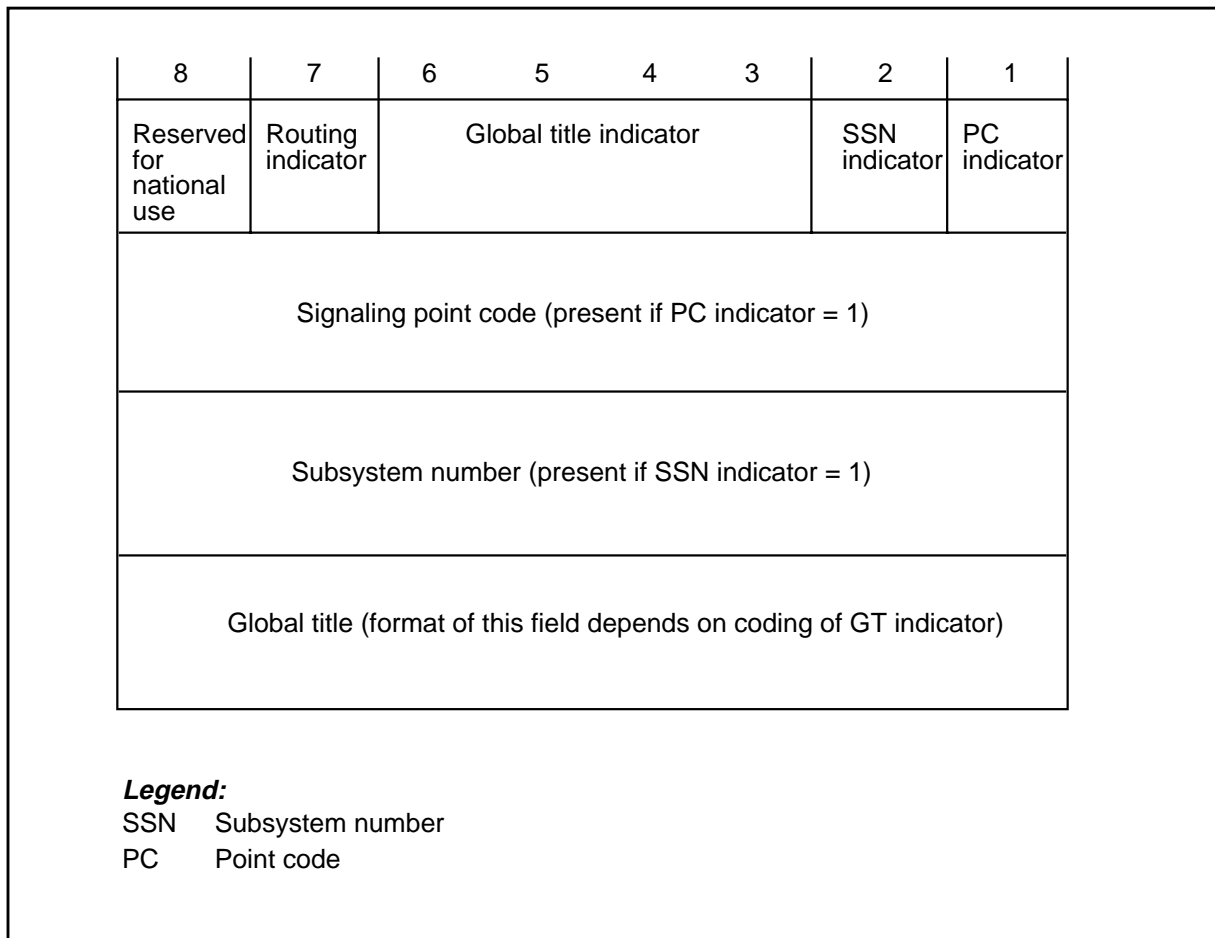
**Format for called party address parameters**

The first octet is the address indicator. The address indicator contains the following indicators:

- bit 1: point code indicator  
This bit indicates if the address includes a signaling point code.
- bit 2: subsystem number indicator  
This field indicates if the address includes a subsystem number.

## **C7GTINT** (continued)

---

- bits 3 - 6: global title indicator

These bits indicate the nature of the global title. The value of this indicator determines the format of the global title. The global title can take one of four formats that the "Global title" section describes.

The global title indicator value can be 0000 with no global title included, or any value not recognized. When this event occurs, the SCCP implementation performs the message return procedure.

- bit 7: routing indicator

This bit indicates if Global Title on the Destination Point code in the MTP routing must determine routing. The SCCP implementation performs the message return procedure if Global Title receives any value other than 0.

This bit is always set to 0 (route on global title).

- bit 8: reserved for national use

The SCCP function does not process this bit. The SCCP function passes this bit clearly.

### **Global title**

The global title is part of the called or calling party address field. The global title follows the PC and SSN fields if these fields are present. Each of the four values in the global title indicator identifies a different format of global title. A description of global title formats appears in Q.713, section 3.4.2.3. The characteristics and translation method of each format appear in the following diagrams and associated text.

The format of the global title for global title indicator 0001 appears in the following figure.

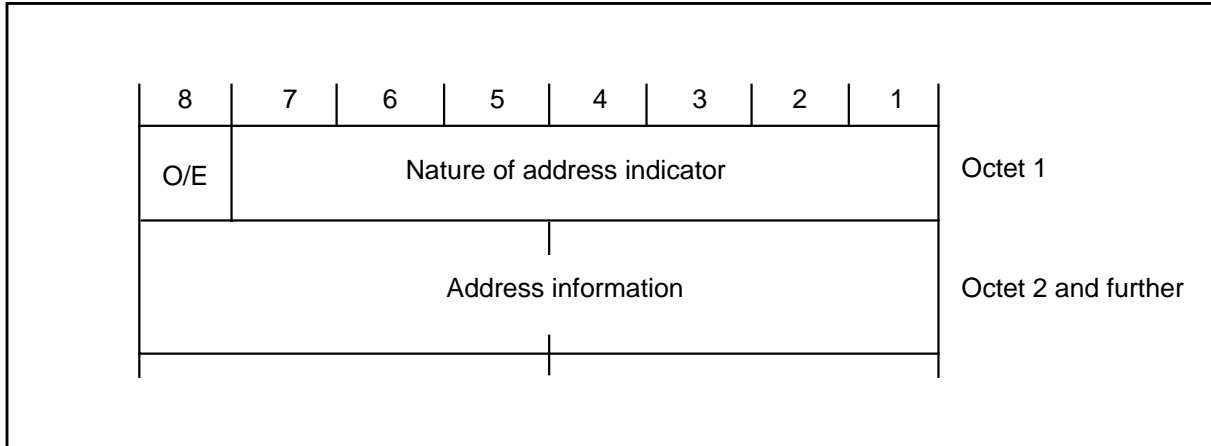
**C7GTINT** (continued)**Global title format for indicator 0001**

If the global title indicator received is 0001, the SCCP function recognizes the numbering plan as E.164. The numbering plan uses only Binary Encoded Decimal (BCD) encoding.

The SCCP function examines the nature of address indicator to determine if the number is a national significant number (00000011) or an international number (00000100). If the system receives 00000000 (not used) or any other code, the SCCP function assumes the number is international.

The odd or even indicator can be 1 to indicate an odd number of address signals. If this condition occurs, the system ignores the last four bits in the parameter. The acceptable code for these bits is 0000.

The format of the global title for global title indicator 0010 appears in the following figure.

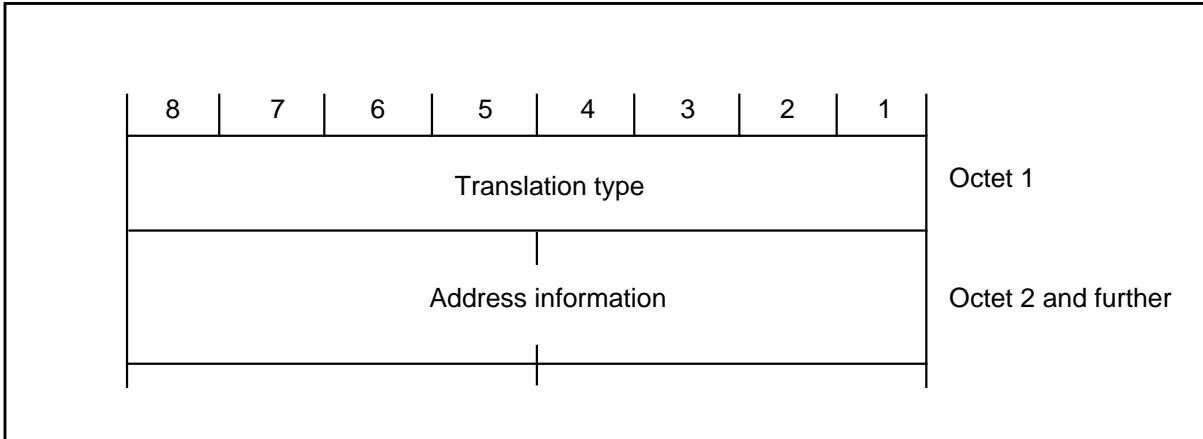
**C7GTINT** (continued)**Global title format for indicator 0010**

The SCCP function examines the translation type for the global title indicator 0010. The SCCP function does not support translation types that are not zero. If the value of the translation type is 00000000, not used, the translation uses the following defaults:

- Numbering plan = E.164
- Nature of address = international number
- O/E = even unless ST code in last 4 bits of final address octet.
- Coding = BCD

The format of the global title for global title indicator 0011 appears in the following figure.

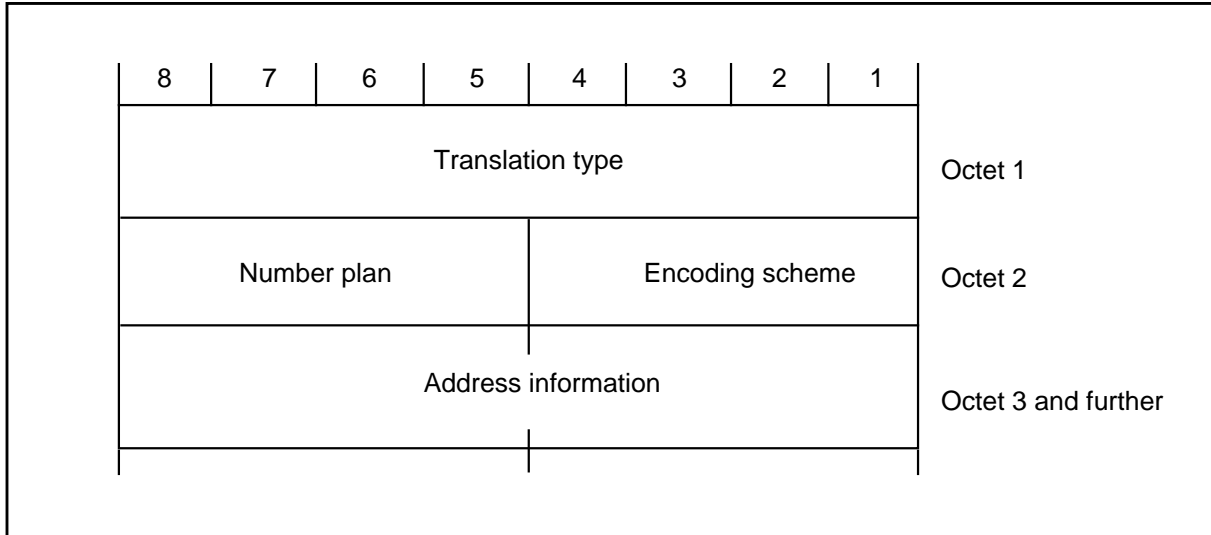
**C7GTINT** (continued)**Global title format for indicator 0011**

The format for global title indicator 0011 is the same as the format for indicator 0010. The translation for this type of global title follows.

If the translation type is 00000000, the SCCP assumes the nature of address is international number. The SCCP examines the numbering plan. The SCCP examines the encoding design fields. If the numbering plan field is 0000, not known, the SCCP assumes E.164. Correct codes for this field include 0001, E.164; and 0111, E.214. If the SCCP receives one of these codes, the SCCP performs the correct translation. If the SCCP receives any other code, the SCCP performs the message return procedure.

The SCCP checks the encoding design field.

If the SCCP receives 0001, the coding is BCD, odd number of digits.

If the SCCP receives 0010, the coding is BCD, even number of digits.

If the SCCP receives 0000, not known, the SCCP assumes BCD even number of digits. The SCCP treats any other code received as BCD or even.

An ST code in the address information field, indicates the end of address information to the SCCP. If this event occurs, the digits expected can be even or odd.

The format of the global title for global title indicator 0100 appears in the following figure.

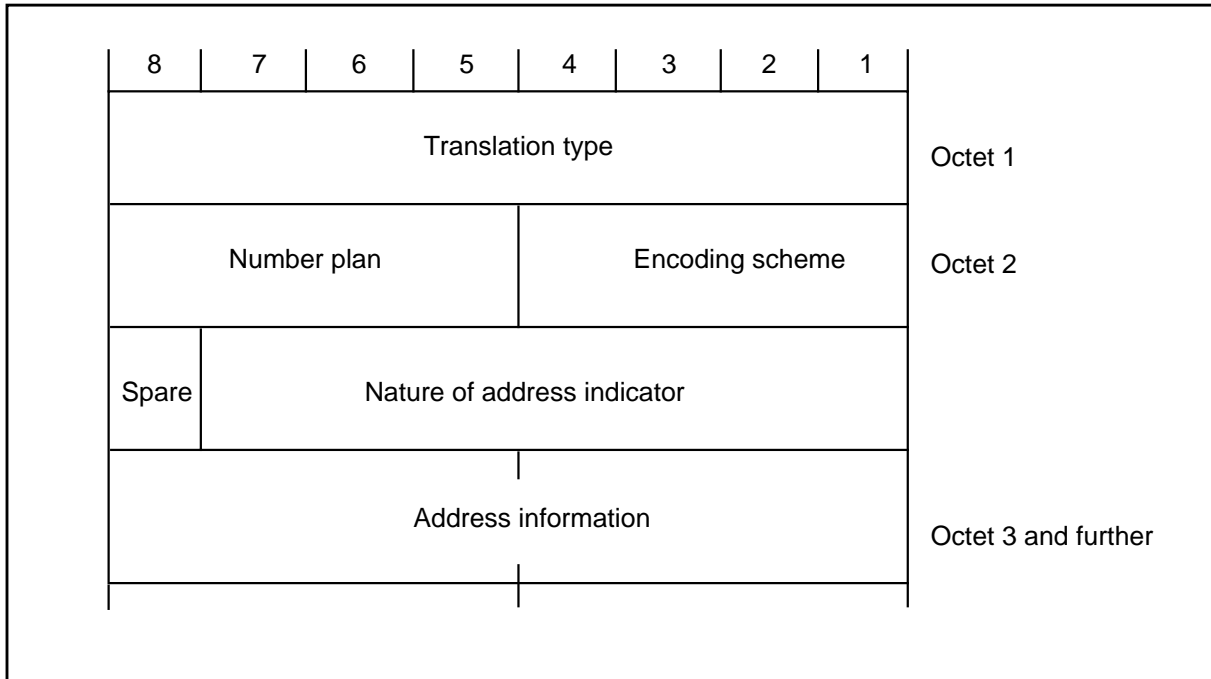
**C7GTINT** (continued)**Global title format for indicator 0100**

The format for global title indicator 0100 is the same as the preceding format. The SCCP processes this format by the same method as 0011. The SCCP checks the nature of address indicator to obtain an address type.

The SCCP checks the numbering plan, encoding design and nature of address fields to obtain a translation. The SCCP uses defaults when the fields do not specify a type.

**Translation of called party address information**

The SCCP checks the fields in the address parameter of a Unitdata or Unitdata Service message, and applies the defaults. This process generates the following results:

- a translation type: (zero if not used)
- a numbering plan: E.164 or E.214
- a nature of address: international or national number
- an encoding design: BCD, odd or even number of digits
- a number of address digits



**C7GTINT** (continued)

The SCCP passes this information to translations to obtain the routing information for the message.

The numbering design can be E.164 or E.214. The numbering design determines the format the global title takes. These formats appear in the following figures.

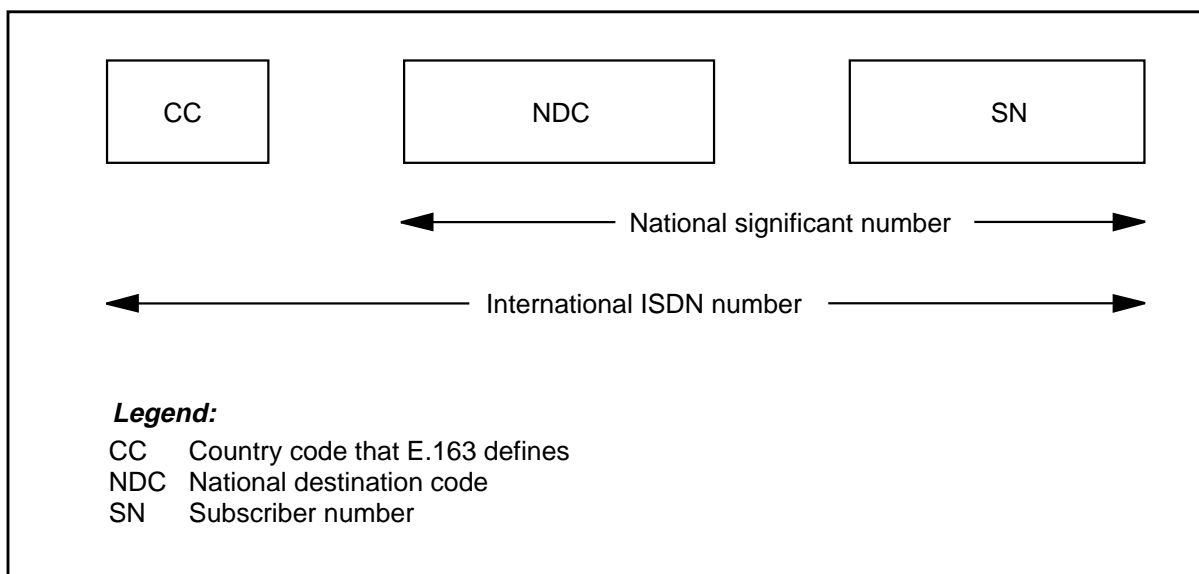
**E.164 number structure**

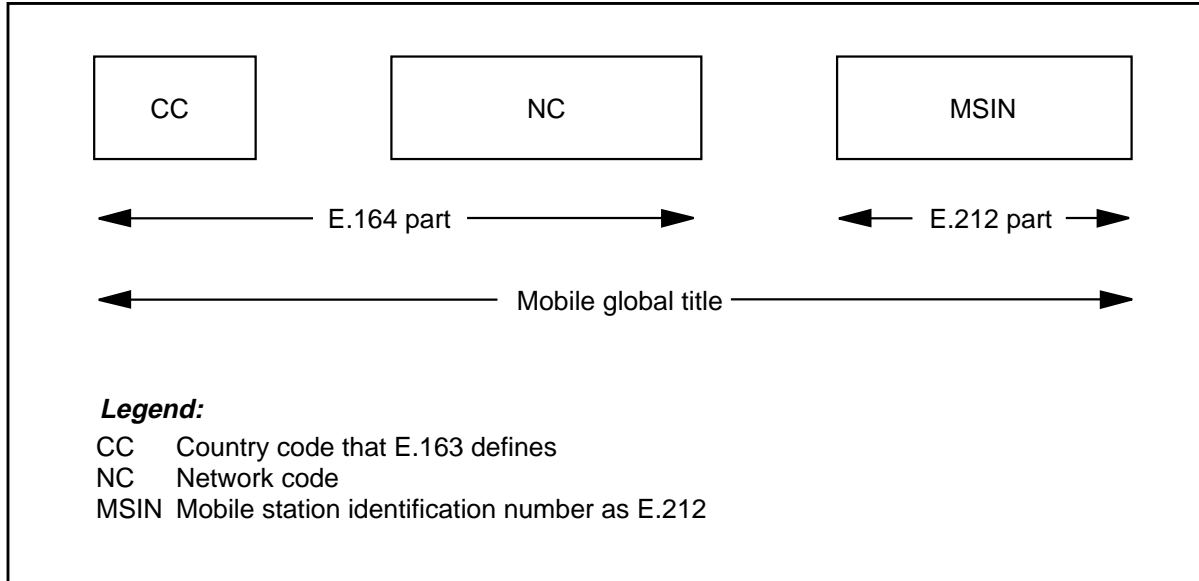
**C7GTINT** (continued)**E.214 number structure**

The format of the number in the global title field when the field indicates E.164 appears in figure “E.164 number structure”. The same format for E.214 appears in figure “E.214 number structure”. For analysis, a difference is not made between these types. Treat the NDC and NC as equivalent.

The SCCP applies the address information to translation tables. This addition generates the following:

- a point code. The MTP receives this code as a Destination Point Code (DPC) for the SCCP message.
- a second point code for use if the primary route fails
- a subsystem number. A translation can generate this number. The SCCP inserts this number in the correct field of the called party address parameter of the transmitted message.
- a modified global title. The SCCP deletes the country code and sets the nature of address field to national.

The control of the called party number appears in the following figure.

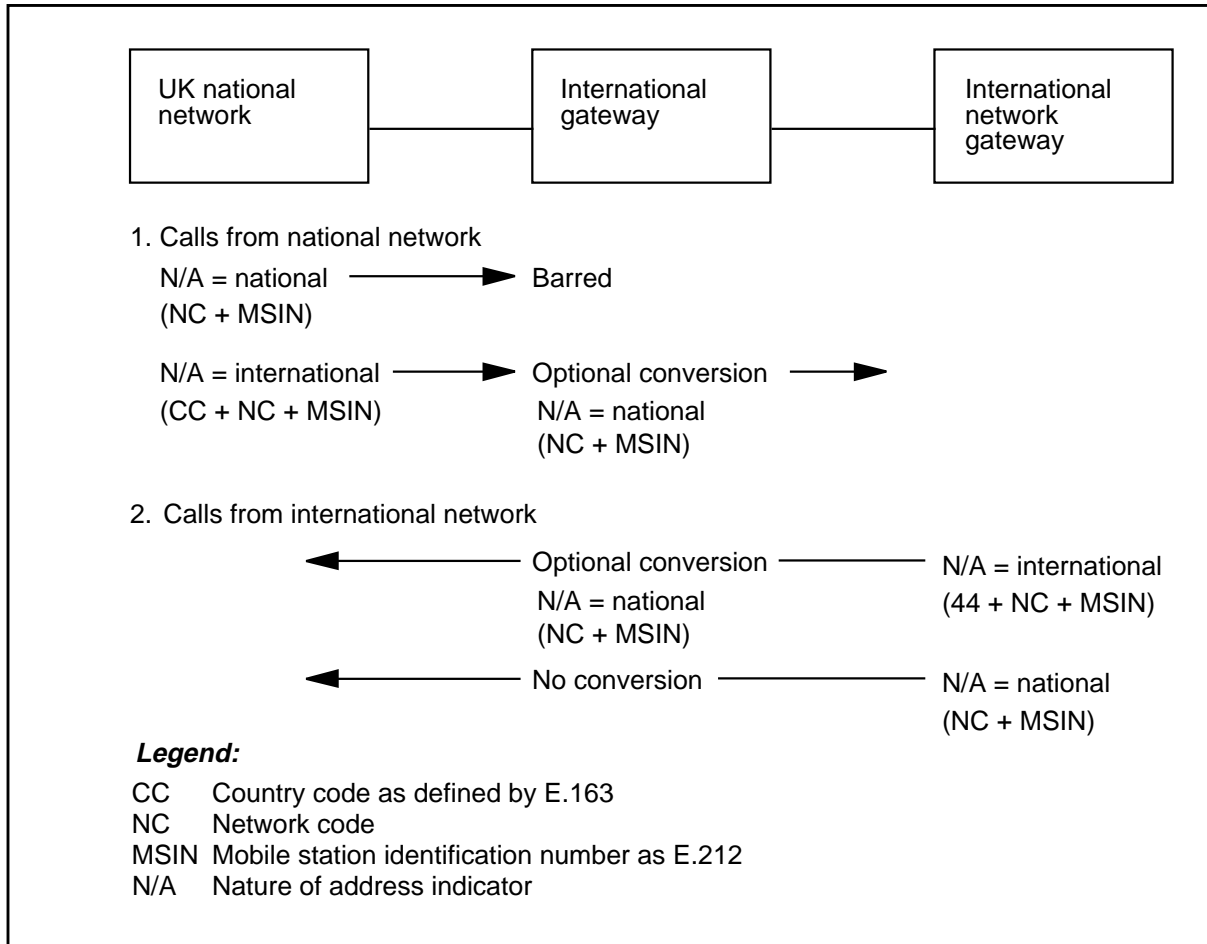
**C7GTINT** (continued)**Conversion to perform on a called party address****Conversion of a calling party address**

When the SCCP receives the calling party address, the SCCP screens the address to check that the minimum number of octets are present. The protocol defines this minimum number.

Control occurs if the nature of address indicates that the calling party number is a national number. The translation inserts the local country code before the number. The translation changes the nature of address to international.

If the subsystem number is present, the translation does not change this number. The control of a calling party number appears in the following figure.

**C7GTINT** (continued)

**Conversion perform on a calling party address**

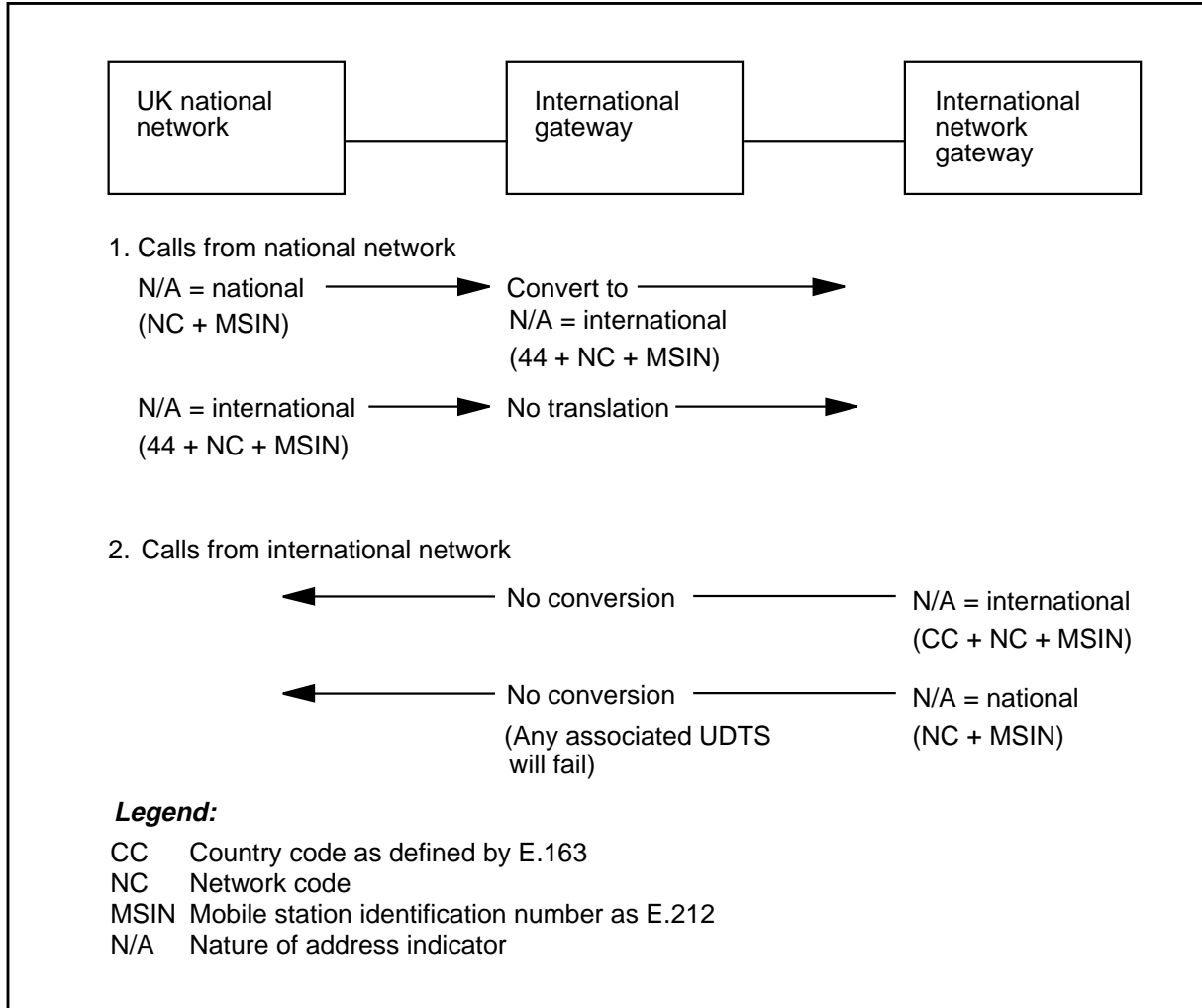

**SCCP routing**

When SCCP receives a UDT message, the SCCP checks the protocol class of the message. These actions occur before translation of global title occurs.

If the message is protocol class 1, the SCCP retains the signaling link selector (SLS) field in the incoming message. The SCCP transmits the SLS again to the MTP as SLS for the outgoing message. This procedure preserves the message sequencing.

The SCCP translates the global title to obtain a DPC. If the DPC is not available and a definition of a different DPC occurs, the SCCP uses the different DPC.

---

**C7GTINT** (continued)

---

If the SCCP can trace a correct and available DPC, the SCCP starts the message return procedure.

**Message return procedure**

If the SCCP cannot route a received message for reasons other than syntax error, the SCCP starts the message return procedure.

Message return can occur if bits 8-5 in the protocol class parameter of the received message are set to 1000. This setting indicates a return message on error. If this field receives any other value, the SCCP discards any messages that the SCCP cannot route.

**Global title conversion of a calling party address**

To manipulate the calling party address, the SCCP converts national numbers to international numbers. This procedure applies only to numbering plans E.164 and E.214. The local country code (44 for UK) is in office parameter NATIONAL\_COUNTRY\_CODE. The SCCP performs this procedure only on messages from the national to the international networks.

**Global title translation of a called party address**

The translation function requires the following inputs:

- optional translation type
- nature of address
- numbering plan
- address digits

The translation function provides:

- destination point code
- optional new global title
- optional subsystem number

Translations can change the global title and the global title type is preserved.

The translation sequence checks if the translation type is available. If the translation type is available, the translation type specifies the translation function the translation must perform.

The SCCP function does not support translation types that are not zero.

---

## C7GTINT (end)

---

If the translation type is not present or is zero, a standard numbering plan determines translation. The SCCP function supports numbering plans E.164 and E.214. The SCCP uses the BCD encoding design.

The following tables configure translations of E.164 and E.214 numbers:

- C7GTINT (Global Title International Translation)
- C7GTNAT (Global Title National Translation)

If the nature of address indicates that the called party is an international number, the entry of an international translation table occurs. If the nature of address indicates a national number, the entry of the national translation table occurs. This procedure appears in the following figure.

### Translation of a called party address

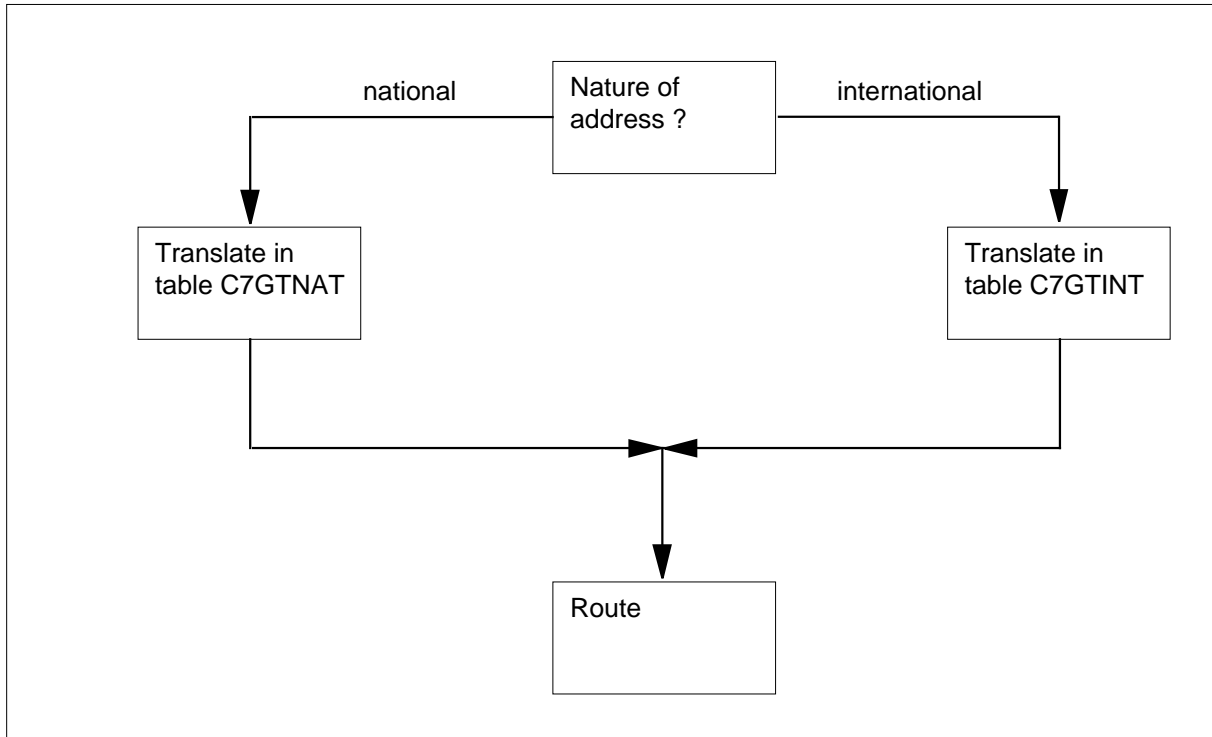

---

**C7GTNAT**

---

**Table name**

CCS7 Global Title National Translation Table

**Functional description**

Table C7GTNAT is available on gateway switches (DMS-300) that support the signaling connection control part (SCCP) gateway function.

Table C7GTNAT provides translation of national SCCP global titles. The "nature of address" field in the SCCP address format indicates a national address. The numbering and a national code range determines translation.

The system supports two numbering plans: CCITT E.164 and CCITT E.214. Plan CCITT E.164 is the integrated services digital network (ISDN) numbering plan. Plan CCITT E.214 is the mobile global title numbering plan.

The translation result contains a maximum of two routes. Each route is a PC (point code) or PC/SSN (subsystem number) combination. For each route, assume that the system performs additional translation at the remote PC. Assume that the system sends SCCP message to the SS7 network with the "routing indicator" field set to global title (GT). Each route has an associated cost. The preferred or primary route is the route with the lower cost. The system uses the other route if the primary route becomes congested or fails.

See table C7GTINT for additional information.

**Datafill sequence and meaning**

You must enter data in table C7NETSSN before you enter data in table C7GTNAT. In other occurrences, the system does not recognize the entry in field PCNAME.

**Table size**

The number of user entries determines table size. The system allocates table size. The number of entries depends on memory requirements.

**C7GTNAT** (continued)**Datafill**

The datafill for table C7GTNAT appear in the following table.

**Field descriptions (Sheet 1 of 3)**

Field	Subfield or refinement	Entry	Description
GTNKEY		see subfields	<i>Global title national translation key.</i> This key field contains subfields NP, NATCFROM, and NATCTO.
	NP	E164, E124	<i>Numbering plan.</i> Enter E164, if the numbering plan is CCITT E.164, the ISDN numbering plan. Enter E214, if the numbering plan is CCITT E.214, the mobile global title numbering plan.  This entry allows operating company personnel to configure two numbering plans with different translations.
	NATCFROM	numeric (1 to 8 digits)	<i>From national or network code.</i> Enter a 1-digit to 8-digit number assigned as the national destination code for an international ISDN number. Enter a number assigned as the network code of a mobile global title number. This number can represent a single code or the first code in a block of following codes. These codes have the same result.
	NATCTO	numeric (1 to 8 digits)	<i>To national or network code.</i> If the entry in field NATCFROM represents a single code, enter the same single code as in NATCFROM. The entry in field NATCFROM can represent the first code of a block of following codes. In this occurrence, enter the last code in the block.
VALID		Y or N	<i>Translation supported.</i> Enter Y (yes), if the system supports the translation of this address. In other occurrences, enter N (no). If the system does not support the translation of the address, the system generates a UDTS message.  If the entry in this field is N (no), the fields that remain are not required.



**C7GTNAT** (continued)

## Field descriptions (Sheet 2 of 3)

Field	Subfield or refinement	Entry	Description
	RESLIST	see subfields	<p><i>Results list.</i> If the entry in field VALID is Y, enter data in this field. In other occurrences, leave this field blank.</p> <p>This field contains subfields RESTYPE, PCNAME, SSNUM, and COST.</p> <p>This field contains a maximum of two routing results. Each result has an associated COST. The result with the lower COST forms the primary. The result with the higher COST forms the backup. Equal COSTs can assume load sharing but the system does not support this option.</p>
	RESTYPE	PCSSN PCONLY	<p><i>Result type.</i> This field is a vector of a maximum of two routing results. This field contains subfields PCNAME, SSNUM, and COST.</p> <p>If the translation results in a destination point code, enter PCONLY. Enter data in subfields PCNAME and COST.</p> <p>If the translation results in a destination point code and a subsystem number, enter PCSSN. Enter data in subfields PCNAME, SSNUM, and COST.</p>
	PCNAME	alphanumeric	<p><i>Destination point code name.</i> Enter the destination point code name of the next node to translate the SCCP message. Table C7NETSSN must contain this destination point code name.</p>

**C7GTNAT** (continued)**Field descriptions (Sheet 3 of 3)**

Field	Subfield or refinement	Entry	Description
	SSNUM	1 to 254	<i>Destination subsystem number.</i> If the entry in file RESTYPE is PCSSN, enter the new subsystem number. The called party address contains the new subsystem number.  If the entry in file RESTYPE is PCONLY, leave this field blank.
	COST	0 to 99	<i>Relative cost of route.</i> Enter a value between 0 and 99. This value specifies a routing preference. A unit of COST is not available. If two results occur, the one with the lower COST is the preferred or primary route. The result with the higher COST is the backup route. The system uses the backup if a failure of the primary route occurs. Equal values for COST assume load sharing but the system does not support this option.

**Datafill example**

Sample datafill for table C7GTNAT appears in the following example.

The example consists of an incoming SCCP message. This message contains the following information:

- the nature of address: national
- the numbering plan: E214
- the address digits are 237-----

The translation result:

- Route to D500STP. The D500STP has the lowest cost.
- If you cannot route to D500STP, route to D400STP. Use subsystem number 244, in the called party address parameter of the transmitted message, to route to D400STP.

**C7GTNAT** (end)**MAP example for table C7GTNAT**

GTNKEY VALID				RESLIST			
E214	234	238	Y	PCONLY	D500STP		20
				PCSSN	D400STP	244	40\$

## C7GTT

---

### Table name

CCS7 Global Title Translation Table

### Functional description

Table C7GTT maps global titles (GT) for particular translation types to Common Channel Signaling 7 (CCS7) network addresses. Each GT corresponds to an application address, such as a sequence of dialed digits used for an 800 number for Enhanced 800 Service (E800).

CCS7 network addresses are used by the signaling connection control part (SCCP) and the message transfer part (MTP) for the routing of messages to their destinations. A CCS7 network address, the result of a global title translation (GTT), can correspond to an error, a point code (PC), a subsystem number (SSN), a PC and an SSN, or a PC and new GT. If SSN only is supplied, the local PC is assumed. DRU="STP">The GRPRSLT result references a group result in table C7GTRSLT.

Table C7GTT is indexed by a key that consists of an internal translation name and a range of digits for which the results apply. The translation type name must have been previously datafilled in table C7GTTTYPE. For each translation, either one or two results are provided.

If one result is given and it is a member of a replicated pair (datafilled in table C7RPLSSN), the member acts as the primary member and carries all the signaling messages. If the primary member of the replicated pair becomes unavailable (due to failure or manual busy), the other member of the replicated pair, (which was not given as a result in table C7GTT) will not carry any traffic. To ensure the secondary replicate carries traffic if the primary replicate becomes unavailable, both members of the replicate pairs must be given as results.

If two results are given, SCCP routing control selects one of the results. Field COST indicates the preferred result (least cost). If the costs are identical, the messages are loadshared. If the preferred route is unavailable, the alternate route is used if possible.

If GT manipulation results in an error, message processing fails, a CCS log is generated, and, if required, a unit data service message (UDTS) is returned to the originator. If the manipulation fails on the CM, a CCS228 log is generated. If the manipulation fails on the PM, a CCS241 is generated.

---

**C7GTT** (continued)

---

**Adding a GT translation to table C7GTT**

To add a GT translation, the following information is required:

- the internal translation name
- the global title FROMDIG index, specifying the lower bound of the GT range for which the set of results apply
- the GT TODIG index, specifying the upper bound of the GT range for which the set of results apply
- the list of results

**Modifying a GT translation in table C7GTT**

The following rules apply to the modification of fields in table C7GTT:

- The list of results can be altered. A new list of results is entered by repeating those that have not changed and adding any new results.
- Field COST in the result can be altered. The costs of two results can only be different if the results consist of a PC and SSN.
- A range can be split by positioning on a subrange and changing the results.

**Deleting a GT translation from table C7GTT**

Deletion of a range or subrange of GT values is allowed. Since GT ranges and subranges are unique, the deletion leaves a gap in the translation table for GTs within the deleted range or subrange.

**Datafill sequence and implications**

Table C7GTTTYPE must be datafilled with additional GTTs before table C7GTT.

The following tables must be datafilled before table C7GTT:

- C7NETSSN
- C7RPLSSN

**Table size**

0 to 60 000 for a DMS integrated node (INode) office with 8-Mbyte CCS7 link interface units (LIU7)

*Note:* When the size of table C7TRKMEM increases beyond 20 000, the limit of table C7GTT reduces to 25 000.

0 to 25 000 tuples for an SSP, a service control point (SCP), or an INode load that is configured to operate as an SSP office

**C7GTT** (continued)

0 to 200 000 tuples for a DMS-STP office

*Note:* GTT is provisioned on the DMS-STP switch in increments using software optionality control (SOC). The increments are 60 000 tuples, 100 000 tuples, 150 000 tuples, and 200 000 tuples. The base limit is 60 000 tuples.

**Datafill**

The following table lists datafill for table C7GTT.

**Field descriptions (Sheet 1 of 10)**

Field	Subfield or refinement	Entry	Explanation and action
GTTKEY		see subfields	<i>Global title translation key</i> This field, which is the key to the table, consists of subfields GTTNAME, FROMDIG, and TODIG.
	GTTNAME	alphanumeric (1 to 16 characters)	<i>Global title translation name</i> One of the predefined GT translation names previously datafilled in table C7GTTTYPE.
	FROMDIG	vector of up to 18 digits(0 to 9)	<i>From digits</i> Enter a number to identify the lower bound of the GT range for which the translation results apply. This field is a digit string that identifies the start of the GT. For example, 326 indicates the GTs starting with 326.  This field is limited to 10 digits for GTTNAMEs ACCSGT, OLNSGT, BNSGT, and LNPGT.
	TODIG	vector of up to 18 digits(0 to 9)	<i>To digits</i> Enter a number to identify the upper bound of the GT range for which the translation results apply. This field is a digit string that identifies the end of the GT. For example, if the entry in field FROMDIG is 326 and the entry in field TODIG is 388, then all GTs starting with 326 to all GTs starting with 388 make up the range of GTs for which the translation results apply. The entry in field TODIG must be greater or equal to the entry in field FROMDIG.  This field is limited to 10 digits for GTTNAMEs ACCSGT, OLNSGT, BNSGT, and LNPGT.

**C7GTT** (continued)

## Field descriptions (Sheet 2 of 10)

Field	Subfield or refinement	Entry	Explanation and action
GTRSLT		see subfield	<i>Global title translation result</i> This field consists of subfield RESULT and refinements.
	RESULT	ERROR NEWGT PCNEWGT PCONLY PCSSN SSONLY GRPRSLT	<p><i>Global translation result type</i> This field contains the GT translation result type for the specified GT translation name and range.</p> <p>If the translation result is an error, enter ERROR. There are no additional refinements to datafill.</p> <p>If the translation result is a new global title, enter NEWGT and datafill refinements GTI, ACTDIG, RESTYPE, and ROUTING.</p> <p><b>Note:</b> CCITT SCCP translations require the input parameters provided by subfield NEWGT and refinements. (CCITT refers to the Consultative Committee on International Telephony and Telegraphy.)</p> <p>If the translation result is made up of a destination point code (DPC) for the multiprotocol controller (MPC) and a new GTT type for the SCCP message, enter PCNEWGT and datafill refinement PC_NEW_GT_RESULTS.</p> <p>If the translation result is a DPC for use by the message transfer part (MTP) in the outgoing SCCP message, enter PCONLY and datafill refinements PC_RESULTS and ROUTING.</p> <p>If the translation result is a DPC that is for use by the MTP, and a subsystem number to replace or add to the outgoing SCCP message, enter PCSSN and datafill refinements PC_SSN_RESULTS and ROUTING.</p> <p>If the translation result provides routing to a local subsystem that is resident on this particular switch, enter SSONLY and datafill either a '\$' or the refinement SSNAME. As the node is assumed to be local, either one SSNAME is allowed or a '\$'. A '\$' indicates that the SSNAME value is to be derived from the message being processed.</p>

**C7GTT** (continued)

## Field descriptions (Sheet 3 of 10)

Field	Subfield or refinement	Entry	Explanation and action
	GTI	GTI_1, GTI_2, GTI_3, GTI_4, or \$	<p><i>Global title indicator selector</i></p> <p>This refinement sets the format of the outgoing called party GT.</p> <p>To convert the format of the GT to a global title indicator (GTI) of 0001 and update the NA value, enter GTI_1 and datafill refinement NA.</p> <p>To convert the format of the GT to a GTI of 0010 and update the GTNUM value, enter GTI_2 and datafill refinement GTNUM.</p> <p>To convert the format of the GT to a GTI of 0011 and update the GTNUM and NP values, enter GTI_3 and datafill refinements GTNUM and NP.</p> <p>To convert the format of the GT to a GTI of 0100 and update the GTNUM, NP, and NA values, enter GTI_4 and datafill refinements GTNUM, NP, and NA.</p> <p>To leave the current GTI value unchanged, enter \$.</p>
	GTNUM	0 to 255	<p><i>Global title translation number</i></p> <p>Enter the network-defined numerical value for the given translation name. Translation types for internetwork services are assigned in ascending order, starting with 0 (zero). Translation types for network specific services are assigned in descending order, starting with 255.</p> <p>If functional group STPS0001 (STP SEAS) is present, no modification to the entry in field GTNUM is allowed.</p>
	NP	E164, E212, E214, or NP_ UNKNOWN	<p><i>Numbering plan</i></p> <p>Enter the numbering plan for CCITT SCCP.</p>
	NA	INTL, NATL, or NA_ UNKNOWN	<p><i>Nature of address</i></p> <p>Enter the nature of address for CCITT SCCP.</p>



**C7GTT** (continued)

## Field descriptions (Sheet 4 of 10)

Field	Subfield or refinement	Entry	Explanation and action
	ACTDIG	ADD_DIGS, DELETE_ DIGS, REPLACE_ DIGS, or \$	<p><i>Digits activity selector</i></p> <p>This refinement specifies the manner in which digits of the outgoing called party GT are manipulated.</p> <p>To add datafillable digits starting from the first, enter ADD_DIGS and datafill refinement DIGITS with the digits to add.</p> <p>To delete up to 18 digits starting from the first, enter DELETE_DIGS and datafill refinement NUM with the number of digits to delete.</p> <p>To replace a specified number of digits anywhere in the digit field, enter REPLACE_DIGS and datafill refinements FROMDIG, TODIG, and DIGITS.</p> <p>To skip to the next field and leave the digits unchanged, enter \$.</p>
	FROMDIG	0 to 18	<p><i>From digit</i></p> <p>Enter the digit position at which digit replacement is required to begin.</p>
	TODIG	0 to 18	<p><i>To digit</i></p> <p>Enter the digit position at which digit replacement is required to end.</p>
	DIGITS	vector of up to 18 digits (0 to 9)	<p><i>Replacement digits</i></p> <p>Enter a digit string consisting of the required replacement digits.</p>
	NUM	1 to 18	<p><i>Number of digits to delete</i></p> <p>Enter the number of digits to delete. Entry values outside the 1 to 18 range are not valid.</p>

**C7GTT** (continued)

## Field descriptions (Sheet 5 of 10)

Field	Subfield or refinement	Entry	Explanation and action
	RESTYPE	NEWGT_ PCONLY, NEWGT_ PCSSN	<p><i>Routeset type</i></p> <p>This refinement consists of an outgoing destination point code (DPC), and optionally a second DPC, followed by a routing indicator.</p> <p>To specify a new GT that consists of a DPC only, enter NEWGT_PCONLY and datafill refinement PC_RESULTS.</p> <p>To specify a new GT that consists of both a DPC and a subsystem number (SSN), enter NEWGT_PCSSN and datafill refinement PC_SSN_RESULTS.</p>
	PC_NEW_ GT_ RESULTS	see subfields	<p><i>Point code new GT results</i></p> <p>This refinement is a vector of one or two multiples of subfields PCNAME, GTTNUM, and COST. If less than two multiples are required, end the list with a \$ (dollar sign).</p> <p>A field COST value must be associated with each PCNAME given. If two PCNAMEs are specified, the field COST values must be identical since only loadsharing is permitted between point codes (PC). The PCs must be defined in table C7NETSSN. The GTNAME in the result is assumed to be the same type as the GT being translated.</p>
	PC_ RESULTS	see subfields	<p><i>Point code results</i></p> <p>This refinement is a vector of one or two multiples of subfields PCNAME and COST. If less than two multiples are required, end the list with a \$ (dollar sign).</p> <p>A COST must be associated with each PCNAME given. If the costs are different, the result with the least cost is the primary point code, and the other is the backup point code. All messages are routed to the primary point code unless it fails, in which case the messages are routed to the backup point code. The PCs must be defined in table C7NETSSN.</p>

**C7GTT** (continued)

## Field descriptions (Sheet 6 of 10)

Field	Subfield or refinement	Entry	Explanation and action
	PC_SSN_RESULTS	see subfields	<p><i>Point code subsystem name results</i></p> <p>This refinement is a vector of one or two multiples of subfields PCNAME, SSNAME, and COST. If less than two multiples are required, end the list with a \$ (dollar sign).</p> <p>Each network subsystem name (SSNAME) must be defined in table C7NETSSN. If two SSNAME entry values are given, they must be defined in table C7RPLSSN as replicates.</p> <p>An entry value for field COST must be associated with each PC and SSN combination. If the costs are different, the result with the least cost is the primary subsystem and the other is the backup subsystem. All messages are routed to the primary subsystem unless it fails, in which case the messages are routed to the backup subsystem. If only one result is given, no backup routing occurs even if the subsystem is replicated in table C7RPLSSN.</p>
	PCNAME	alphanumeric (1 to 16 characters)	<p><i>Point code name</i></p> <p>Enter a valid PC name previously datafilled in table C7NETSSN. If two PCs are specified, they are loadsharing replicates for the translation.</p>
	SSNAME	alphanumeric (1 to 8 characters)	<p><i>Subsystem name</i></p> <p>Enter a valid subsystem name that was previously datafilled in table C7LOCSSN. The meanings of the pre-defined subsystem names are described below.</p>
		ACCS	Enter ACCS to specify the automatic calling card service subsystem.
		ACCTSS	Enter ACCTSS to specify the account code validation subsystem.
		AIN01	Enter AIN01 to specify the advanced intelligent network (AIN) 0.1 messaging subsystem.
		AUTHSS	Enter AUTHSS to specify the authcode verification subsystem.

**C7GTT** (continued)**Field descriptions (Sheet 7 of 10)**

<b>Field</b>	<b>Subfield or refinement</b>	<b>Entry</b>	<b>Explanation and action</b>
		BNS	Enter BNS to specify the billing number screening subsystem.
		CMS	Enter CMS to specify the call management service subsystem.
			<b>Note:</b> Canada only
		CNAMD	Enter CNAMD to specify the Custom Local Area Signaling Service (CLASS) Calling Name Delivery (CNAMD) subsystem.
		CS1R	Enter CS1R to specify the Capability Set 1 (CS1) subsystem.
		E800	Enter E800 to specify the enhanced 800 service subsystem.
		INTERWRK	Enter INTERWRK to specify the subsystem that is used for features that are interworked between PRA and SS7.
		ISDNUP	Enter ISDNUP to specify the ISDN user part subsystem.
		MAPMSC	Enter MAPMSC to specify the mobile application part mobile switching center.
		NMS	Enter NMS to specify the network message service subsystem. In BCS30, this subsystem name is only used by the network message waiting indicator.
		N00	Enter N00 to specify the N00 calling service subsystem.
		OAM	Enter OAM to specify the operations, administration, and maintenance subsystem.
		OLNS	Enter OLNS to specify Originating Line Number Screening.

**C7GTT** (continued)

## Field descriptions (Sheet 8 of 10)

Field	Subfield or refinement	Entry	Explanation and action
		PRA	Enter PRA to specify the primary rate access subsystem. This subsystem allows Network Ring Again (NRAG) on primary rate access (ISDN PRA).
		PVN	Enter PVN to specify the private virtual network subsystem.
		RTRS	Enter RTRS to specify the TOPS Real-Time Rating System.
		SCPACCS	Enter SCPACCS to specify the ACCS database (SCP) subsystem.
		SCPBNS	Enter SCPBNS to specify the BNS database (SCP) subsystem.
		SCPE800	Enter SCPE800 to specify the E800 database (SCP) subsystem.
		TCN	Enter TCN to specify the travel card service subsystem.
		TOPSLNP	Enter TOPSLNP to specify TOPS Local Number Portability.
		TUP	Enter TUP to specify the telephone user part subsystem.
		800P	Enter 800P to specify the 800 Plus subsystem, which is the Canadian version of CCS7 800 service. 800P is provided if feature package X555 (800 Plus) is in the switching unit. Otherwise, E800 is provided.
		NSSTCN	Enter NSSTCN to specify the network services software (NSS) travel card number subsystem.
		REPLDIGS	Enter REPLDIGS to specify the NSS DBCP replace dialed digits application subsystem.
	GTTNUM	0 to 255	<i>Global title translation number</i> Enter a numeric value for the GT translation number.

**C7GTT** (continued)

## Field descriptions (Sheet 9 of 10)

Field	Subfield or refinement	Entry	Explanation and action
	COST	0 to 99	<p><i>Cost</i> Enter a numeric value to specify the routing preference. There is no unit of cost.</p> <p>If a GTT has two results, the one with the least cost is the preferred route. If two results have the same cost, there is no preferred route and traffic is loadshared.</p> <p>If two results have the same cost and either of the routes has a linkset with more than eight A, E, or F links, the system displays the following error message:</p> <p>Result contains routeset with route that exceeds link limit of 8.</p> <p><b>Note:</b> The restriction indicated by this error message applies to ITU and NTC7 networks only.</p>

**C7GTT** (continued)**Field descriptions (Sheet 10 of 10)**

<b>Field</b>	<b>Subfield or refinement</b>	<b>Entry</b>	<b>Explanation and action</b>
	ROUTING	GT or SSN	<p><i>Routing</i></p> <p>If the entry in subfield RESULT is NEWGT, PCSSN, or PCONLY, enter either GT or SSN as detailed below.</p> <p>If the entry in subfield RESULT is NEWGT or PCSSN and the final destination SSN has been determined but the destination point code has not been determined, enter GT. This indicates that the final destination SSN must be placed in the called party address and further translation is required at the new node to determine the DPC.</p> <p>If the entry in RESULT is NEWGT or PCSSN and both the final destination SSN and the DPC have been determined, enter SSN. This indicates that no further translation is required and the message can be routed to its destination.</p> <p>If the entry in subfield RESULT is PCONLY and the SSN is not in the called party address, enter GT. This indicates that the destination point code (DPC) must be altered and the message routed to that node for further translation.</p> <p>If the entry in subfield RESULT is PCONLY and the SSN is already in the called party address, enter SSN. This indicates that, with the addition of the new DPC, the final destination of the message is known and the message can be routed to its destination.</p>

**Datafill example**

An example of datafill for table C7GTT is shown below. Refer to table C7NETSSN for an example that illustrates the interaction of table C7GTT with other related tables.

The example shows datafill for table C7GTT.

## C7GTT (end)

---

### Datafill example for table C7GTT

GTTKEY		GTTRSLT	
BTI	5001	7001	
NEWGT GTI_4 7 E164 INTL DELETE_DIGS 3 NEWGT_PCONLY			
IPTRT1 2 IPTRT2 2 GT			
LNPGT 0 9 GRPRSLT LNPGROUP			

### Table history

#### CSP14

Added error message to field COST.

#### SHR12

Added table size restrictions for an INode office. Removed STP SOC state error message.

#### CSP08

Added STP SOC state error message.

#### TOPS07

Value TOPSLNP added to field SSNAME by feature AF6549 in functionality TOPS LNP, OSEA0008.

Size note added to fields FROMDIG and TODIG by feature AF6549.

#### GL03

Added the Capability Set 1 (CS1) subsystem.

#### STP03

Added 200 000 tuple limit for DMS-STP switch according to feature AR1618. Also indicated SOC levels for GTT on the DMS-STP switch. Changed functional group information for SEAS.



---

**C7GTTDF**

---

**Table name**

CCS7 Global Title Translation Delta File

**Functional description**

Table C7GTTDF reduces the recovery time of a signaling transfer point (STP) or an STP/service switching point (SSP) integrated node (INode). Faster recovery is possible because of a reduction in the time that the system requires to synchronize data in tables C7GTT and C7GTTYPE. Synchronization occurs during the return-to-service (RTS) process of one of the following peripheral modules:

- CCS7 link interface unit (LIU7)
- high-speed link interface unit (HLIU)
- high-speed link router (HSLR)

Table C7GTTDF contains a list of recent updates to tables C7GTT and C7GTTYPE. Synchronization is faster because the system downloads the recent updates and not the contents of tables C7GTT and C7GTTYPE.

Table C7GTTDF contains the following information:

- additions, changes, and deletions to table C7GTTYPE
- changes in translation type and range of translation digits in table C7GTT
- translation result records that changes in the translation type and the range of translation digits in table C7GTT create
- translation result records that tuple changes to table C7NETSSN create
- translation result records that tuple changes to table C7DCIS6 create

Table C7GTTDF is a read-only table. The system enters data in this table. Operating company personnel cannot edit this table. Operating company personnel can view the contents of the file.

The office parameter C7GTT\_DELTA\_FILE\_ACTIVITY\_STATE starts or stops the C7GTTDF table.

**Datafill sequence and meaning**

Operating company personnel cannot enter data in table C7GTTDF.

**Table size**

If office parameter C7GTT\_DELTA\_FILE\_ACTIVITY\_STATE is ON or INACTIVE, the table contains 4096 tuples.

**C7GTTDF** (continued)

If office parameter `C7GTT_DELTA_FILE_ACTIVITY_STATE` is OFF, the table contains 1 tuple.

**Datafill**

Datafill for table `C7GTTDF` appears in the following table.

**Field descriptions**

Field	Subfield or refinement	Entry	Description
DFKEY		C7GTT-DF_KEY	<i>Delta file key</i> This field contains subfield INDEX.
	INDEX	numeric (0 to 4095)	<i>Index of DFKEY</i> This subfield identifies the index of the tuple of the table.
ACTION		ADD, MODIFY, or DELETE	<i>Action</i> This field identifies the action associated with the delta file entry.
UPINDEX		numeric (0 to 4095)	<i>Update index</i> This field identifies the entry in the table that contains the most recent addition to the delta file.
UPDDATA		C7_GTT_DF_RECTYPE_AREA	<i>Update data</i> This field identifies the content of the delta file update.
	RECTYPE	TRANSLATION_TYPE, RESULT, or DIGITS	<i>Record type</i> This field identifies the data type of the delta file entry. This field has multiple entries for subfields OLDTYPE and NEWTYPE.

**C7GTTDF** (continued)**RECTYPE = TRANSLATION\_TYPE**

If the entry in field RECTYPE is TRANSLATION\_TYPE, enter data in fields OLDTYPE, NEWTYPE, or TRANS and the associated subfields.

**Field descriptions for conditional datafill (Sheet 1 of 4)**

Field	Subfield or refinement	Entry	Explanation and Action
	OLDTYPE	see subfields	<p><i>Old translation type</i></p> <p>This subfield identifies the old translation type. This subfield contains the subfield NETWRK.</p> <p>The old translation type has an applied value if ACTION has an entry of MODIFY or DELETE.</p>
	NETWRK	CCITT7, ANSI7, NTC7, TTC7, or JPN7	<p><i>Network</i></p> <p>This subfield identifies the type of network.</p>
	GTNUM	numeric (0 to 255)	<p><i>Global title number</i></p> <p>If the entry in subfield NETWRK is CCITT7, ANSI7, or NTC7 the system enters data in this subfield. This subfield identifies the translation type number.</p>
	NA	NA_UN-KNOWN NA_SPA-RE_1, NA_SPA-RE_2, NATL, INTL, NA_SPA-RE_5, NA_SPA-RE_6, NA_SPA-RE_7,	<p><i>Nature of address</i></p> <p>If the entry in subfield NETWRK is CCITT7, ANSI7, or NTC7 the system enters data in this subfield. This subfield identifies the nature of the address type associated with the translation type.</p>

**C7GTTDF** (continued)**Field descriptions for conditional datafill (Sheet 2 of 4)**

<b>Field</b>	<b>Subfield or refinement</b>	<b>Entry</b>	<b>Explanation and Action</b>
	NP	NP_UN-KNOWN E164, NP_SPA-RE_2, NP_SPA-RE_3, NP_SPA-RE_4, NP_SPA-RE_5, E212, E214, NP_SPA-RE_8, NP_SPA-RE_9, NP_SPA-RE_A, NP_SPA-RE_B, NP_SPA-RE_C, NP_SPA-RE_D, NP_SPA-RE_E, or NP_SPA-RE_F	<i>Numbering plan</i>  If the entry in subfield NETWK is CCITT7 or NTC7 the system enters data in this subfield. This subfield identifies the numbering plan associated with the translation type.
	NEWTYPE	see subfield	<i>New translation type</i>  This field identifies the new translation type. This field contains the subfield NETWRK.  The new translation type has an applied value if ACTION has an entry of MODIFY or DELETE.
	NETWK	CCITT7, ANSI7, NTC7, TTC7, or JPN7	<i>Network</i>  This subfield identifies the type of network.
	GTNUM	numeric (0 to 255)	<i>Global title number</i>  If the entry in subfield NETWK is CCITT7, ANSI7, or NTC7 the system enters data in this subfield. This subfield identifies the translation type number.

**C7GTTDF** (continued)**Field descriptions for conditional datafill (Sheet 3 of 4)**

<b>Field</b>	<b>Subfield or refinement</b>	<b>Entry</b>	<b>Explanation and Action</b>
	NA	NA_UN-KNOWN NA_SPA-RE_1, NA_SPA-RE_2, NATL, INTL, NA_SPA-RE_5, NA_SPA-RE_6, NA_SPA-RE_7,	<i>Nature of address</i>  If the entry in subfield NETWK is CCITT7 or NTC7 the system enters data in this subfield. This subfield identifies the nature of the address type associated with the translation type.

**C7GTTDF** (continued)**Field descriptions for conditional datafill (Sheet 4 of 4)**

<b>Field</b>	<b>Subfield or refinement</b>	<b>Entry</b>	<b>Explanation and Action</b>
	NP	NP_UN-KNOWN E164, NP_SPA-RE_2, NP_SPA-RE_3, NP_SPA-RE_4, NP_SPA-RE_5, E212, E214, NP_SPA-RE_8, NP_SPA-RE_9, NP_SPA-RE_A, NP_SPA-RE_B, NP_SPA-RE_C, NP_SPA-RE_D, NP_SPA-RE_E, or NP_SPA-RE_F	<i>Numbering plan</i>  If the entry in subfield NETWK is CCITT7 or NTC7 the system enters data in this subfield. This subfield identifies the numbering plan associated with the translation type.
	TRANS	ACCSGT, ACCTGT, AUTHGT, BNSGT, CNAMDGT, CORE, DIGSGT, E800BELL, E800ISDN, E800ITU, E800TELE, MAPISDN, NSSTCNGT, N00GT, OLNSGT, PHONY, PRAGT, PSTNGT, PVNGT, REPL, RTRSGT, TCNGT, ISDNSS, NIL_GT_ TRANS_NAME	<i>Translation name</i>  The system enters the name of a user-defined translation type into this subfield. Table C7GTTYPE is the source for the user-defined translation type. If the user does not assign a name to the translation type, the system enters the value NIL_GT_TRANS_NAME into this subfield.

**C7GTTDF** (continued)**RECTYPE = DIGITS**

If the entry in field RECTYPE is DIGITS, enter data in fields GTTYPE, FRGIDS, TODIGS, GTRESLT and the associated subfields.

**Field descriptions for conditional datafill (Sheet 1 of 2)**

Field	Subfield or refinement	Entry	Explanation and Action
	GTTYPE	see subfields	<i>Global title type</i> This field identifies the translation type to which this update of digits applies.
	NETWK	CCITT7, ANSI7, NTC7, TTC7, or JPN7	<i>Network</i> This subfield identifies the type of network.
	GTNUM	numeric (0 to 255)	<i>Global title number</i> If the entry in subfield NETWK is CCITT7 or ANSI7, the system enters data in this subfield. This subfield identifies the translation type number.
	NA	NA_UN-KNOWN NA_SPA-RE_1, NA_SPA-RE_2, NATL, INTL, NA_SPA-RE_5, NA_SPA-RE_6, NA_SPA-RE_7,	<i>Nature of address</i> If the entry in subfield NETWK is CCITT7, the system enters data in this subfield. This subfield identifies the nature of the address type associated with the translation type.

**C7GTTDF** (continued)**Field descriptions for conditional datafill (Sheet 2 of 2)**

<b>Field</b>	<b>Subfield or refinement</b>	<b>Entry</b>	<b>Explanation and Action</b>
	NP	NP_UN-KNOWN E164, NP_SPA-RE_2, NP_SPA-RE_3, NP_SPA-RE_4, NP_SPA-RE_5, E212, E214, NP_SPA-RE_8, NP_SPA-RE_9, NP_SPA-RE_A, NP_SPA-RE_B, NP_SPA-RE_C, NP_SPA-RE_D, NP_SPA-RE_E, or NP_SPA-RE_F	<i>Numbering plan</i>  If the entry in subfield NETWK is CCITT7, the system enters data in this subfield. This subfield identifies the numbering plan associated with the translation type.
	FRDIGS	numeric (1 to 18 digits)	<i>From digits</i>  This field identifies the lower bound of the range of global titles.
	TODIGS	numeric (1 to 18 digits)	<i>To digits</i>  This field identifies the upper bound of the range of global digits.
	GTRESLT	numeric (-32 768 to 32 767)	<i>Global title result</i>  This field identifies the result table index for this translation.



**C7GTTDF** (continued)**RECTYPE = RESULTS**

If the entry in field RECTYPE is RESULTS, the system enters data in fields IDX, RESULT and EXTRESULT.

**Field descriptions for conditional datafill**

Field	Subfield or refinement	Entry	Explanation and Action
	IDX	numeric (-32 768 to 32 767)	<i>Result index</i>  This field identifies the result table index for this translation.
	RESULT	20 numeric entries (0 to 255)	<i>Result</i>  This field contains the result table that appears as a table of numbers.
	EXTRESULT	24 numeric entries (0 to 255)	<i>Extension result</i>  This field contains the extension result table that appears as a table of numbers.

**For RECTYPE values**

For every field RECTYPE value, enter data in field UPDATKEY and the associated subfields.

**Field descriptions (Sheet 1 of 2)**

Field	Subfield or refinement	Entry	Explanation and Action
UPDATKEY		see subfields	<i>Update key</i>  This field identifies the update key for this delta file entry. This field contains subfields SEQNUMBR and TIMESTMP.
	SEQNUMBR	see subfields	<i>Sequence number</i>  This field identifies the sequence number. This field contains the subfields LSW, DIDW, and MSW.
	LSW	numeric (-32 768 to 32 767)	<i>Least significant word</i>  This subfield identifies the least significant word of the sequence number.

**C7GTTDF** (continued)**Field descriptions (Sheet 2 of 2)**

<b>Field</b>	<b>Subfield or refinement</b>	<b>Entry</b>	<b>Explanation and Action</b>
	MIDW	numeric (-32 768 to 32 767)	<i>Middle word</i>  This subfield identifies the middle word of the sequence number.
	MSW	numeric (-32 768 to 32 767)	<i>Most significant word</i>  This subfield identifies the most significant word of the sequence number.
	TIMESTMP	see subfields	<i>Time stamp</i>  This field identifies the time stamp for the delta file update. This field contains subfields LSW, DIDW, and MSW.
	LSW	numeric (-32 768 to 32 767)	<i>Least significant word</i>  This subfield identifies the least significant word of the time stamp.
	MIDW	numeric (-32 768 to 32 767)	<i>Middle word</i>  This subfield identifies the middle word of the time stamp.
	MSW	numeric (-32 768 to 32 767)	<i>Most significant word</i>  This subfield identifies the most significant word of the time stamp.

**Datafill example**

The following examples show sample datafill for table C7GTTDF. The first example shows the datafill in table C7GTTDF when the parameter C7GTT\_DELTA\_FILE\_ACTIVITY\_STATE is OFF. There is 1 tuple in the table.

**C7GTTDF** (continued)**MAP example for table C7GTTDF**

DFKEY	ACTION	UPDINDEX	UPDATKEY				UPDDATA
0	ADD	0					
TRANSLATION_TYPE	CCITT7	0	NA_UNKNOWN	NP_UNKNOWN	CCITT7	0	NA_UNKNOWN
NP_UNKNOWN	NIL_GT_TRANS_NAME						
0	0	0	0	0	0	0	0

The second example shows part of the datafill in table C7GTTDF when the parameter C7GTT\_DELTA\_FILE\_ACTIVITY\_STATE is ON, but there have been no updates. There are 4096 tuples in the table.

**MAP example for table C7GTTDF**

DFKEY	ACTION	UPDINDEX	UPDATKEY				UPDDATA
0	ADD	0					
TRANSLATION_TYPE	CCITT7	0	NA_UNKNOWN	NP_UNKNOWN	CCITT7	0	NA_UNKNOWN
NP_UNKNOWN	NIL_GT_TRANS_NAME						
0	0	0	0	0	0	0	0
1	ADD	0					
TRANSLATION_TYPE	CCITT7	0	NA_UNKNOWN	NP_UNKNOWN	CCITT7	0	NA_UNKNOWN
NP_UNKNOWN	NIL_GT_TRANS_NAME						
0	0	0	0	0	0	0	0
2	ADD	0					
TRANSLATION_TYPE	CCITT7	0	NA_UNKNOWN	NP_UNKNOWN	CCITT7	0	NA_UNKNOWN
NP_UNKNOWN	NIL_GT_TRANS_NAME						
0	0	0	0	0	0	0	0

The third example shows part of the datafill in table C7GTTDF when the parameter C7GTT\_DELTA\_FILE\_ACTIVITY\_STATE is ON, but there are

## **C7GTTDF** (continued)

---

only three updates in the table. There are 4096 tuples in the table. This table shows the following information:

- The first tuple:
  - A translation (digits) deletion occurs in the ANS17 network.
  - The global title number is 230.
  - The FROM digits are 91657268. The TO digits are 91657268.
  - The result is 32767.
  - This number is change number 20480 because the Delta File is ON.
  - The time stamp of the change is 21999 8221 572.
- The second tuple:
  - A translation (digits) addition occurs in the ANS17 network.
  - The global title number is 230.
  - The FROM digits were 91657268. The TO digits are 91657268.
  - The result is 253.
  - This number is change number 20481 because the Delta File is ON.
  - The time stamp of the change is 23932 8221 572.
- The third tuple:
  - A translation (digits) addition occurs in the ANS17 network.
  - The global title number is 230.
  - The FROM digits were 91657333. The TO digits are 91657333.
  - The result is 32767.
  - This number is change number 20482 because the Delta File is ON.
  - The time stamp of the change is 27094 8221 572.

**C7GTTDF** (end)**MAP example for table C7GTTDF**

DFKEY	ACTION	UPDINDEX									UPDDATA
			UPDATKEY								
0	DELETE	833									
DIGITS	ANSI7	230	916957268	916957268	32767	20480	0	0	21999	8221	572
1	ADD	833									
ANSI7	230	916957268	916957268	253	20481	0	0	23932	8221	572	
2	DELETE	833									
DIGITS	ANSI7	230	91657333	91657333	32767	20482	0	0	27094	8221	572

**Table history****TL11**

Added high-speed link (HSL) references.

**TL10**

Added subfield TRANS for field RECTYPE=TRANSLATION\_TYPR.

**STP02**

Table C7GTTDF was first released for STP02.

## C7GTTYE

---

### Table name

CCS7 Global Title Translation Type Table

### Functional description

Table C7GTTYE defines the profile of a global title (GT). This table associates an application on the switch with a profile.

The table maps a GT translation (GTT) name (GTTNAME), that the user defines, to:

- a network type (NETWK)
- a network-defined GTT type number (GTNUM)
- a nature of address (NA)
- a numbering plan (NP)
- a known GTT identifier (GTTID)

Each GTT name that associates with a subsystem, that DMS software supports, has a different GTTID. The system enters data in field GTTID when a GTT name is entered. This GTT name must correspond to a GTT type that DMS software supports.

Table C7GTTYE provides GT translation according to a group of translation type, numbering plan, and nature of address. This table maps symbolic GTTs to a GTT-type value that the network defines. Table C7GTTYE entry deletions cannot occur if the key entry is entered in table INTCCFMT for field GTNAME.

An internal application defines the translation with:

- a numbering plan (implicit, telephony, or ISDN)
- an encoding design (BCD)
- a function to map the GT to a Common Channel Signaling 7 (CCS7) network address

The function uses the numbering plan and the encoding scheme to map the GT. Each translation type receives a value that the network defines. Internally, each type appears as a value in a symbolic range. This table maps the symbolic ID to the numeric value that the network defines.

---

**C7GTTYE** (continued)

---

If the digilator pool is full or if a digilator pool allocation fails, the system generates following error message:

```
Unable to allocate C7GTT Resources.
```

The key to table C7GTTYE is a GTT name that the user defines.

See table C7NETSSN for additional information.

**Adding a GTT type to table C7GTTYE**

The following information is required to add a translation type:

- a user-defined GTT name
- numeric value that the network defines for the translation type
- predefined GTT identifier

*Note:* This value is not always different. The combination of the GTT type, the numbering plan, and the encoding design must be different. For example, the table can use the telephony numbering plan and the BCD encoding design to give the value 1. This value cannot define another translation with this numbering plan and encoding design.

**Modifying a GTT type in table C7GTTYE**

You can modify translation type number if the translation type, numbering plan, and encoding design triplet remain separate.

**Deleting a GTT type from table C7GTTYE**

You can delete a translation type if table C7GTT does not define translations for the translation type.

**Datafill sequence and meaning**

You do not need to enter data in other tables before you enter data in table C7GTTYE.

Enter data in the following tables after table C7GTTYE:

- BNSPARMS
- CVVPARMS
- C7GTT
- TRIGDIG

**C7GTTYPE** (continued)

- TRIGINFO
- INTCCFMT (optional table)

**Table size**

Maximum of 32 tuples

**Datafill**

Datafill for table C7GTTYPE appears in the following table.

**Field descriptions (Sheet 1 of 4)**

Field	Subfield or refinement	Entry	Description
GTTNAME		alphanumeric (1 to 16 characters)	<i>Global title translation name.</i> Enter a GTT name the user defines, or a pre-defined GTT name.  A deletion cannot occur if this key entry is entered in field GTNAME of table INTCCFMT.
GTTYPE		see subfield	<i>Global translation type.</i> This field contains subfield NETWK and refinements.
	NETWK	CCITT7 or NTC7 or ANSI7	<i>Network type selector.</i> This selector field specifies the network type. For ANSI7 networks, enter ANSI7 and enter data in refinement GTNUM. For CCITT7 networks, enter CCITT7 and enter data in refinements GTNUM, NA, and NP. For NTC7 networks, enter NTC7 and enter data in refinements GTNUM, NA, and NP. Entries JPN7 and TTC7 are not correct for this field.
	GTNUM	0 to 255	<i>Global title translation number.</i> Enter the network-defined numeric value for the given translation name. For internetwork services, assign translation types in ascending order. Start with 0 (zero). For network services, assign translation types in descending order. Start with 255.



**C7GTTYPE** (continued)**Field descriptions (Sheet 2 of 4)**

<b>Field</b>	<b>Subfield or refinement</b>	<b>Entry</b>	<b>Description</b>
	NA	NA_UNKNOWN NA_SPARE_1 NA_SPARE_2 NATL, INTL NA_SPARE_5 NA_SPARE_6 NA_SPARE_7	<i>Nature of address.</i> If the entry in field NETWK is CCITT7 or NTC7, enter the nature of address for CCITT SCCP.

**C7GTTYPE** (continued)

## Field descriptions (Sheet 3 of 4)

Field	Subfield or refinement	Entry	Description
	NP	NP_UNKNOWN E164 NP_SPARE_2 NP_SPARE_3 NP_SPARE_4 NP_SPARE_5 E212E214 NP_SPARE_8 NP_SPARE_9 NP_SPARE_A NP_SPARE_B NP_SPARE_C NP_SPARE_D NP_SPARE_E NP_SPARE_F	<i>Numbering plan</i> . If the entry in field NETWK is CCITT7 or NTC7, enter the number plan for CCITT SCCP.

**C7GTTYE** (continued)**Field descriptions (Sheet 4 of 4)**

Field	Subfield or refinement	Entry	Description
GTTID		ACCSGT	<i>Global title translation identifier.</i> Enter data in this field if the operating company defines and enters a known GTT type. This condition occurs when you enter data for a service switching point (SSP).  If the switching unit is an SSP, enter one of the known global title translation identifiers. If the switching unit is not an SSP, enter \$ (nil).  For advanced intelligent network (AIN) GTTs, enter \$.  For the TOPS Real-time Rating System, enter RTRSGT.  To route queries to the SCP over the ITU network, enter E800ITU.  <b>Note:</b> The addition of value E800ITU increases the range of the GT types.  For ETSI ISDN Supplementary Services, enter ISDNSS.  To associate Wireless Intelligent Networks Global Title Translations (WINGTT) Enhanced 911 calls with the GTTNAME, enter CUSTT00.
		ACCTGT	
		AUTHGT	
		BNSGT	
		CNAMDGT	
		CORE	
		DIGSGT	
		E800BELL	
		E800ISDN	
		E800ITU	
		E800TELE	
		MAPISDN	
		MSCSCPGT	
		NIC_MAP	
		NSSTCNGT	
		N00GT	
		NUMBER_BLOC	
		K_MAP	
		OLNSGT	
		PHONY	
	PRAGT		
	PSTNGT		
	PVNGT		
	REPL		
	RTRSGT		
	TCNGT		
	ISDNSS		
	CUSTGTT00		
	or \$		

**Datafill example**

Sample datafill for table C7GTTYE appears in the following examples.

In the first example, the type of address and number plan values are known for each CCITT7 entry.

A normal datafill that deals with the conditions that are not known appears in the second example.

In the third example, the type of address and number plan values are known for an NTC7 entry.

**C7GTTYPE** (continued)

**MAP example for table C7GTTYPE**

GTTNAME	GTTTYPE				GTTID
GLOBNET	CCITT7	7	INTL	E214	( MAPISDN)\$
TELNET	CCITT7	8	NATL	E164	( E800ISDN)\$
BTIICCV	CCITT7	254	INTL	E214	\$
AMCO	ANSI7	20			( E800)\$
AMCO1	ANSI7	21			\$
ESNSCSCP	ANSI7	250			( CUSGTT00)\$

**MAP example for table C7GTTYPE**

GTTNAME	GTTTYPE				GTTID
TELECOM1	CCITT7	0	INTL	NP_UNKNOWN	\$
TELECOM2	CCITT7	4	NA_UNKNOWN	NP_UNKNOWN	\$
TELECOM2	CCITT7	10	NA_UNKNOWN	E214	\$

**MAP example for table C7GTTYPE**

GTTNAME	GTTTYPE				GTTID
E8001	NTC7	254	INTL	E212	E800BELCORE \$

---

**C7GTTYPE** (end)

---

**Table history****MMP13**

Feature 59012762 added NIC\_MAP and NUMBER\_BLOCK\_MAP.

**LWW0006**

Feature 59011895 added CUSGTT00 as a value for field GTTID.

**EUR006**

Feature AR2196 for ETSI ISDN Supplementary Services added value ISDNSS to field GTTID in EUR006.

**CSP06**

Feature AN1564 in functionality TOPS OLNS Interface, ABS00012 added value OLNS to field GTTID in CSP06.

**NA005**

Value E800ITU was added to field GTTID in accordance with SSP E008 Support for CCITT TCAP in NA005.

**TL05**

Network value NTC7 was added to subfield NETWRK in accordance with feature AR1464 in TL05.

**TOPS04**

Value RTRSGT was added to field GTTID in accordance with feature AN1504 in functionality External RTRS Interface, ENSV0009 in TOPS04.

**UK002**

Value MAPISDN was added to field GTTID in UK002.

**BCS36**

Value CNAMDGT was added to field GTTID in BCS36.

## C7GTWLKS

---

### Table name

CCS7 Gateway STP Linksets Screening Table

### Overview

The CCS7 Gateway STP Screening Tables provide gateway signaling transfer point (STP) screening functions for the DMS-STP switch. The STP is a tandem message switch for Common Channel Signaling 7 (CCS7) networks.

*Note:* Every reference to signaling transfer point (STP) applies to the STP/Service Switching Point (SSP) Integrated Nodes (INode), unless indicated differently.

### Common Channel Signaling 7

The CCS7 is a common channel signaling protocol. The CCS7 transfers circuit and noncircuit-related data in a telecommunications network.

The STP is a node in the CCS7 network. The STP performs the switching (or tandeming) of messages between other nodes in the CCS7 network.

The screening functions are for use in the American National Standards Institute (ANSI) variant of CCS7. Screening functions are available to provide for International Telecommunication Union (ITU) (previously CCITT) screening. The ITU screening is for the message transfer part (MTP), Signaling Network Management (SNM) and the telephone user part (TUP). Partial screening is available for ITU signaling connection control part (SCCP). The MTP screening includes the originating point code (OPC), the destination point code (DPC), and the service information octet (SIO). The SNM and TUP screening includes the H0 and H1 message codes.

### Screening network types

The same screening tables define ANSI, ITU (previously CCITT), and NTC7 screening functions. To distinguish between the different types of screening functions, each rule within a table is assigned one of the three network types:

- ANSI7
- CCITT7
- NTC7

### Gateway STP

An STP that provides connectivity between different CCS7 networks is called a gateway STP. A gateway STP allows one CCS7 network access to the resources of another network, such as databases. Added security is required at

---

**C7GTWLKS** (continued)

---

a gateway STP to guarantee that only authorized users receive access to a resource.

**Gateway STP screening**

Gateway STP screening allows the STP to discard messages from users that are not authorized. This action provides secure access between signaling points (SP) in a CCS7 network.

The gateway STP screens the following messages:

- the MTP and SCCP parts of the ANSI7 CCS7 messages
- the MTP and partial SCCP parts of CCITT7 CCS7 messages
- the MTP and SCCP parts of the NTC7 CCS7 messages

The switch can screen each CCS7 message received at the gateway STP on multiple requirements available through screening tables.

The MTP screening functions include:

- allowed originating point code (allowed OPC)
- blocked originating point code (blocked OPC)
- allowed destination point code (allowed DPC)
- blocked destination point code (blocked DPC)
- allowed service information octet (allowed SIO)
- blocked service information octet (blocked SIO) (not used for ANSI or NTC7 CCS7 messages)
- destination field of signaling network management (SNM) messages

The SCCP screening functions include:

- called party address (CDPA), not used for CCITT7 CCS7 messages
- calling party address (CGPA)
- global title translation (GTT) number
- affected point code and subsystem (PC/SSN), not used for CCITT7 CCS7 messages
- SCCP management (SCMG) messages, not used for CCITT7 CCS7 messages

Gateway screening contains several separate screening functions that the switch performs on incoming messages. Each screening function applies to a specific field in the CCS7 message.

**C7GTWLKS** (continued)

---

Screening functions are grouped into sets based on the field in the message that the switch screens. The gateway screening tables define these screening function sets. A screening function can initiate another screening function from a different set. The screening result rules in the following table make sure that no loops exist in a chain of screening functions.

Each screening function has one of the following results:

- **STOP**

The screening ends and the message proceeds with normal routing. This result must be entered in the screening table.
- **FAIL**

The screening function fails and the system discards the message. This result does not appear in the screening tables. For allowed screening functions, this is the default result when the screening rules do not match the message. For blocked screening functions, the switch uses this result when one of the screening rules matches the message.
- **CONTINUE**

The message passes the current screening function. Screening continues with the next screening function that appears in the screening tables. For the allowed screening functions, the screening rule that matches the message specifies the next function. For blocked screening functions, the default rule specifies the next function. The default rule applies when the other rules do not match the message.
- **ERROR**

The screening cannot proceed because of an error in the screening process. The system terminates screening and routes the message normally. This result cannot appear in the screening tables. This result can occur because of conditions that are not expected. An example of these conditions is SCCP screening on a message that is not an SCCP message. Changes to screening tables can correct this error.

Tables that define the screening functions make sure that a strict ordering occurs on successive screening functions in the screening process. Each message can undergo each type of screening one time. The switch invokes the screening functions in the following order:

1. Allowed OPC
2. Blocked OPC
3. Allowed SIO
4. Blocked SIO (not used for ANSI CCS7 or NTC7 CCS7 messages)



**C7GTWLKS** (continued)

5. Allowed DPC
6. Blocked DPC
7. Destination Field (SNM messages only)
8. CGPA (SCCP messages only)
9. GTT number (SCCP messages only)
10. CDPA (SCCP messages only) (not used for CCITT7 CCS7 messages)
11. Affected PC/SSN (SCMG messages only) (not used for CCITT7 CCS7 messages)

A screening function can only result in a screening function of a higher order. An allowed OPC screening function can result in continued CGPA screening. A CGPA screening function does not always result in OPC screening.

There are other limits on which screening functions can result in another function. The following table shows the possible results of the different screening functions.

For ANSI and NTC7 CCS7, valid results contain an A or •. These values are in the intersection of the screening function and the result in the following table. For CCITT CCS7, valid results contain a C or •. These values are in the intersection of the screening function and the result in the following table.

**Correct screening table results (Sheet 1 of 2)**

Screening function	Result													
	C7	C	C7	C7	C7	C7	C7	C7	C7	C7	C7	ST	FA	
	AL	B	AL	BL	AL	BL	D	C	AL	C	AF	O	IL	
	W	CL	W	K	W	K	ST	G	W	D	TP	P		
	O	K	SI	SI	D	D	FL	P	G	P	C			
	P	O	O	O	P	P	D	A	TT	A				
	C	P			C	C								
		C												
C7GTWLKS	•	•	•	C	•	•						•		
C7ALWOPC		•	•	C	•	•	•	A				•		
C7BLKOPC			•	C	•	•	•	A				•	•	
C7ALWSIO				C	•	•	•	•		A		•		
C7BLKSIO					C	C	C					C	C	
C7ALWDPC						•	•	A				•		

**C7GTWLKS** (continued)**Correct screening table results (Sheet 2 of 2)**

Result			
C7BLKDPC	•	A	• •
C7DSTFLD			•
C7CGPA	•	A	•
C7ALWGTT		A	•
C7CDPA			A A
C7AFTPC			A

**Screening tables**

Each screening table contains a set of screening functions. All of the screening functions in a table screen the same field of a CCS7 message. All screening functions in the allowed OPC table (C7ALWOPC) screen on the OPC field of the message.

A four-character screening reference identifies each screening function in the table. Each screening function has a maximum of 256 different screening rules. A screening rule specifies a set of screening requirements, for example a range of point codes, and a result applied if the message being screened matches the screening criteria. Each screening rule is uniquely identified by its screening reference and a rule number (0 to 255). The set of all rules with the same reference in a screening table make up a screening function.

Each screening table can be an allowed or blocked screening table. The screening rules in allowed tables specify the values in the allowed CCS7 messages. If one of the screening rules in an allowed function matches the screened message, then the result of that screening rule is applied (either "stop" or "continue" with another screening function). If none of the screening rules in an allowed function matches the screened message, then it is assumed the message is not allowed and it is discarded. All screening tables, with the exception of C7BLKOPC, C7BLKDPC and C7BLKSIO, are of this type.

The screening rules in blocked tables specify the values in the CCS7 messages that are not allowed. Each function in a blocked screening table has a default rule. One of the screening rules in a blocked function can match the screened message. When this condition occurs, the system does not allow the message and discards the message. If the screening rules in a blocked function do not match the screened message, the switch applies the result of the default rule. This result is stop or continue with another screening function. The three screening tables of this type are C7BLKOPC, C7BLKDPC, and C7BLKSIO.

**C7GTWLKS** (continued)

The gateway linkset table (C7GTWLKS) specifies the screening attributes of CCS7 linksets. This table specifies the first screening function applied to incoming messages. The first function can initiate additional screening functions. Each linkset can have a different set of screening functions. This table enables or disables screening on separate linksets. This table specifies log threshold values for the gateway screening logs for each linkset.

**Screening in the LIU7 or HSLR for CCS7 messages**

The following figure shows the path of CCS7 messages in the LIU7 or HSLR. A discrimination function handles incoming messages. This discrimination function determines if the message is for a local service or for another network node. The system passes messages, where the DPC is the point code (PC) or capability code of the STP, to the distribution function. The distributor examines the service information octet (SIO) to determine the local service for the message. The system passes messages with a service indicator of 0 to the signaling network management (SNM) function. The system passes messages with a service indicator of 3 to the signaling connection control part (SCCP) function. If global title translation (GTT) is required, the SCCP performs the GTT. The system routes the message to a local subsystem or to another network node through the MTP.

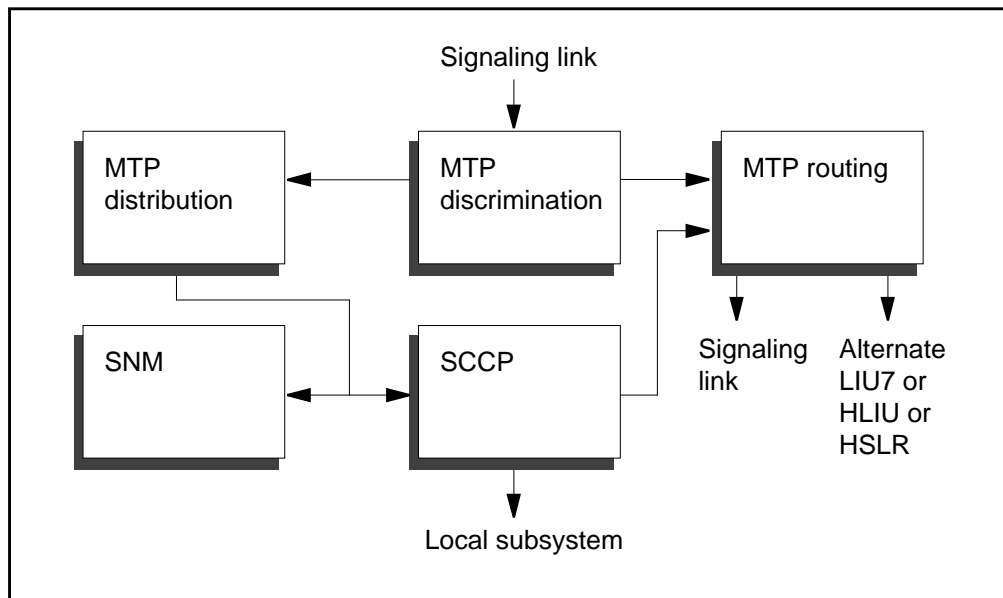
**Signaling functions in the LIU7 or HSLR for CCS7 messages****Screening functions in the LIU7, HLIU or HSLR for CCS7 messages**

The following figure shows where the gateway screening functions fit into the LIU7, HLIU, or HSLR. Two sets of functions are present. Datafill determines which function can be invoked.

## **C7GTWLKS** (continued)

---

The MTP screening functions include:

- Allowed OPC
- Blocked OPC
- Allowed DPC
- Blocked DPC
- Service Information Octet (SIO)
- Destination Field (DESTFLD) screening

The SCCP screening functions include:

- Called Party Address (CDPA)
- Calling Party Address (CGPA)
- Global Title Translation (GTT) number
- Affected Point Code (AFTPC) screening

If MTP screening functions are required, the switch invokes these functions before the normal MTP discrimination function. The switch can invoke the SCCP screening from one of two locations. The switch distributes the message to the SCCP function in the LIU7 or HSLR, the SCCP invokes the appropriate SCCP screening functions. If the message does not require SCCP routing, the MTP discrimination function invokes the SCCP screening functions. This action occurs before the MTP discrimination function passes the message to the MTP routing function.

**C7GTWLKS** (continued)**Screening functions in the LIU7, HILU or HSLR****Functional description**

Table C7GTWLKS defines the gateway screening parameters that associate with a linkset. These parameters include the first screening function, the log report threshold values, and the operational measurement (OM) register sets.

The following rules apply:

- Only ANSI, CCITT, or NTC7 linksets can be entered in table C7GTWLKS. The entry in field FEPC in table C7LKSET specifies the network type.
- The entry in field RESULT can specify a screening function. When this condition occurs, the network type of that function must be the same as the network type of the linkset. The network type can be ANSI7, CCITT7, or NTC7. The network type of the linkset. Field FEPC in table C7LKSET specifies the network type.

## **C7GTWLKS** (continued)

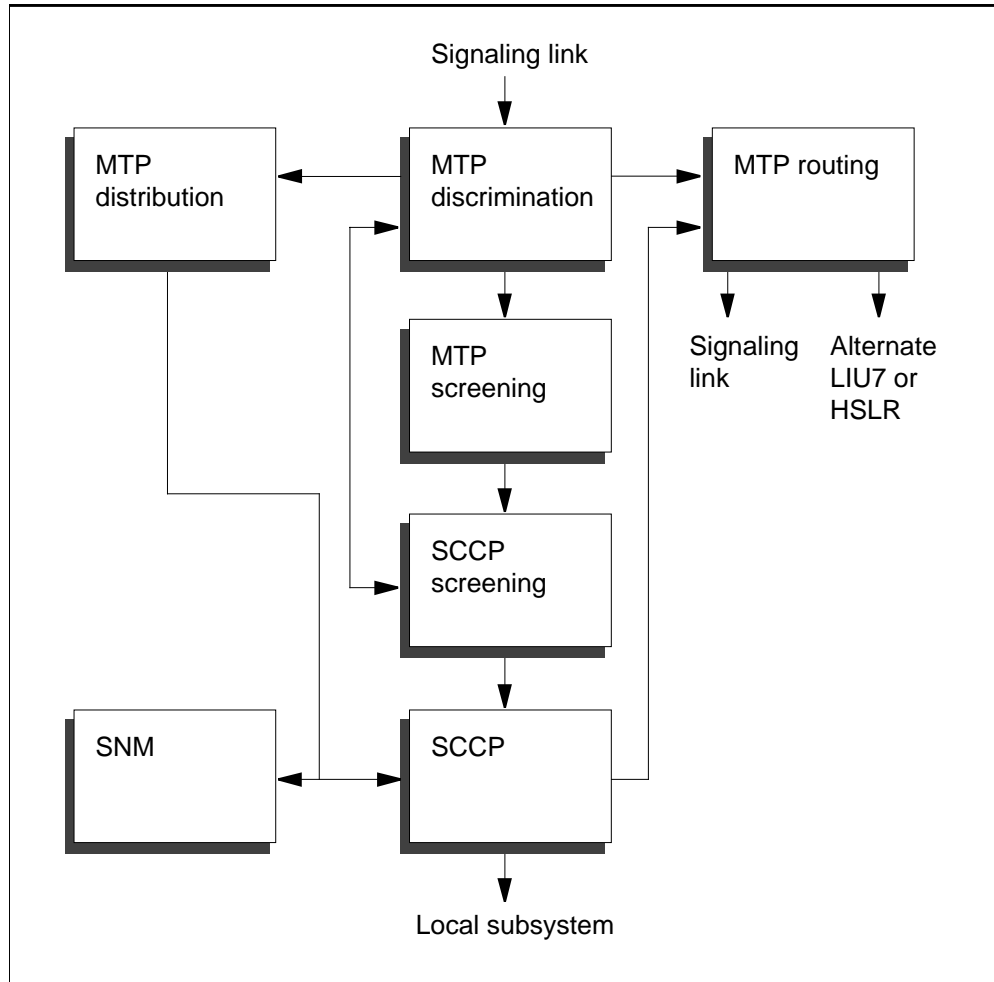
---

### **Datafill sequence and meaning**

You must enter data in the following tables before you enter data in table C7GTWLKS:

- C7ALWOPC
- C7BLKOPC
- C7ALWSIO
- C7BLKSIO
- C7ALWDPC
- C7BLKDPC
- C7DSTFLD
- C7CGPA
- C7ALWGTT
- C7CDPA
- C7AFTPC
- C7LKSET

### **Table size**

256 tuples

108 tuples for a switch with the BRISC processor

72 tuples for a switch without the BRISC processor

Each linkset entered in table C7LKSET can have a corresponding entry in table C7GTWLKS. The maximum number of tuples in C7GTWLKS is the same as for table C7LKSET.

**C7GTWLKS** (continued)**Datafill**

Datafill for table C7GTWLKS appears in the following table.

**Field descriptions (Sheet 1 of 5)**

Field	Subfield or refinement	Entry	Description
LINKSET		see subfield	<i>Link set key</i> This field contains subfield LS_NAME.
	LS_NAME	alphanumeric (1 to 16 characters)	<i>Link set name</i> Enter the linkset name for which screening occurs. The linkset name is a vector that table C7LKSET defines.
ENABLED		Y or N	<i>Screening enabled</i> Enter Y (yes) if the switch activates gateway screening for this screening function when the data downloads to the LIU7 or HSLR. Otherwise, enter N (no).  <b>Note:</b> Changes to the value of this field turns screening on or off without removal of datafill.
SCREEN		see subfields	<i>Screening functions</i> This field contains subfield RESULT.
	RESULT	STOP C7ALWOPC C7BLKOPC C7ALWSIO C7BLKSIO C7ALWDPC C7BLKDPC	<i>Next result</i> Enter the type of screening that the switch performs next. If the entry is STOP, do not enter data in additional subfields. For all other entries, enter data in subfield NEXTREF.
	NEXTREF	alphanumeric (a maximum of 4 characters)	<i>Next screening reference</i> If the entry in field RESULT is not STOP, enter the value in field REFERNCE of the screening table specified in field RESULT. This entry designates the next screening function to perform.  If the entry in subfield RESULT is STOP, leave subfield NEXTREF blank.

**C7GTWLKS** (continued)

## Field descriptions (Sheet 2 of 5)

Field	Subfield or refinement	Entry	Description
LINKGRP		0 to 99 or \$	<p><i>Link group ID</i></p> <p>Enter a numeric link group ID to associate several linksets to a group for the CGPA (Calling Party Address) screening function.</p> <p>If the rule includes all link groups, enter \$.</p>
MSUDSCRD		see subfield	<p><i>Message signal units discarded</i></p> <p>This field refers to the number of MSUs a screening function discards. This field contains subfield CCS500ACT.</p>
	CCS500ACT	Y or N	<p><i>CCS500 log report activated</i></p> <p>The system can generate a CCS500 log each time the threshold limit is reached in successive time PERIODs. When this condition occurs, enter Y and enter data in subfields LIMIT and PERIOD.</p> <p>If the system does not generate a CCS500 log, enter N and leave subfields LIMIT and PERIOD blank.</p>
	LIMIT	1 to 999 999	<p><i>Threshold limit</i></p> <p>If the entry in field CCS500ACT is Y, enter the number of MSUs that the system must discard, within the time period defined in field PERIOD, to generate a CCS500 log.</p> <p>If the entry in field CCS500ACT is N, leave the field blank.</p>
	PERIOD	5, 10, 15, 20, or 30	<p><i>Time period</i></p> <p>Entries outside this range are not valid. If the entry in field CCS500ACT is Y, enter the duration of the time period during which the value in field LIMIT is not to be exceeded. Enter the time in minutes. If the value in field LIMIT is reached or exceeded during the time period, the system generates a CCS500 log.</p> <p>If the entry in field CCS500ACT is N, leave the field blank.</p>



**C7GTWLKS** (continued)

## Field descriptions (Sheet 3 of 5)

Field	Subfield or refinement	Entry	Description
MSURECVD		see subfield	<i>Message signal units received</i>  This field refers to the number of MSUs received from other networks. This field contains subfield CCS501ACT.
	CCS501ACT	Y or N	<i>CCS501 log report activated</i>  The system can generate a CCS501 log each time the threshold limit is reached in successive time periods. When this condition occurs, enter Y and enter data in subfields LIMIT and PERIOD.  If the system does not generate a CCS501 log, enter N. Leave subfields LIMIT and PERIOD blank.
	LIMIT	1 to 999 999	<i>Threshold limit</i>  If the entry in field CCS501ACT is Y, enter the number of MSUs that the system must receive to generate a CCS501 log. The system must receive the MSUs within the time period defined in field PERIOD.  If entry in field CCS501ACT is N, leave this field blank.
	PERIOD	5, 10, 15, 20, or 30	<i>Time period</i>  Entries out of this range are invalid. If the entry in field CCS501ACT is Y, enter the time period during which the value in field LIMIT cannot be exceeded. The time in minutes. If the value in field LIMIT is reached or exceeded during the time period, the system generates a CCS501 log.  If the entry in field CCS501ACT is N, leave this field blank.
SCRFAILS		see subfield	<i>Screening function failures</i>  This field refers to the number of CCS502 log reports required to reach the threshold value in field LIMIT. This requirement applies when the system does not generate more log reports until the end of the time PERIOD. The CCS502 logs report the number of MSUs that a screening function discards. This field contains subfield CCS502ACT.

**C7GTWLKS** (continued)

## Field descriptions (Sheet 4 of 5)

Field	Subfield or refinement	Entry	Description
	CCS502ACT	Y or N	<p><i>CCS502 log report activated</i></p> <p>The system generates log CCS502 to report the number of MSUs that a screening function discards. If the system generates this log, enter Y and enter data in fields LIMIT and PERIOD.</p> <p>If the system does not generate a CCS502 log, enter N. Leave fields LIMIT and PERIOD blank.</p>
	LIMIT	1 to 999 999	<p><i>Threshold limit</i></p> <p>If entry in field CCS502ACT is Y, enter the number of MSUs that must be discarded by a screening function during the time period specified by the entry in field PERIOD, to generate a CCS502 log report. When the number of MSUs discarded reach this threshold limit, one CCS502 log is generated and no further CCS502 logs are generated until the next time period.</p> <p>If entry in field CCS502ACT is N, leave field blank.</p>
	PERIOD	5, 10, 15, 20, or 30	<p><i>Time period</i></p> <p>Entries out of this range are not valid. If the entry in field CCS502ACT is Y, enter the time period during which the value in field LIMIT cannot be exceeded. The time period is in minutes. If the the value in field LIMIT is reached or exceeded during the time period, the system generates one CCS502 log. The system does not generate more CCS502 logs until the next time period.</p> <p>If entry in field CCS502ACT is N, leave field blank.</p>
SCRERROR		see subfield	<p><i>Screening function errors</i></p> <p>This field refers to the number of CCS503 log reports the system can generate. When the number of CCS503 log reports generated reaches the threshold value in field LIMIT, no further log reports are generated until the end of the time PERIOD. CCS503 logs are used to report the number of errors that have occurred in a screening function. This field consists of subfield CCS503ACT.</p>

**C7GTWLKS** (continued)

## Field descriptions (Sheet 5 of 5)

Field	Subfield or refinement	Entry	Description
	CCS503ACT	Y or N	<p><i>CCS503 log report activated</i></p> <p>If the system generates a CCS503 log to report the number of errors that occur during a screening function, enter Y. Enter data in subfields LIMIT and PERIOD.</p> <p>If the system does not generate a CCS502 log, enter N. Leave fields LIMIT and PERIOD blank.</p>
	LIMIT	1 to 999 999	<p><i>Threshold limit</i></p> <p>If the entry in field CCS503ACT is Y, enter the number of errors during a screening function that must occur during the time period that field PERIOD specifies to generate a CCS503 log report. When the number of errors during a screening function reaches this threshold limit, the system generates one CCS503 log. The system does not generate more CCS503 logs until the next time period.</p> <p>If entry in field CCS502ACT is N, leave field blank.</p>
	PERIOD	5, 10, 15, 20, or 30	<p><i>Time period</i></p> <p>Entries outside this range are not valid. If the entry in field SCRERROR is Y, enter a value. This value specifies the time period during which the value in field LIMIT cannot be exceeded. The time period is in minutes. If the value in field LIMIT is reached or exceeded, during the time period, the system generates one CCS503 log. The system does not generate more CCS503 logs until the next time period.</p> <p>If entry in field CCS503ACT is N, leave field blank.</p>
REMARKS		alphanumeric (1 to 8 characters)	<p><i>Remarks</i></p> <p>The operating company specifies this field. This field can identify the name of the network or carrier to which the link connects. This field can store eight-character values. Avoid the use of special characters, such as +, *, /, -, and %.</p>
OPTIONS		see subfields	<p><i>Options</i></p> <p>Enter \$, which is the only valid entry.</p>

## C7GTWLKS (continued)

### Datafill example

The following example shows sample datafill for table C7GTWLKS.

The example defines the gateway STP screening parameters that associate with linkset LNKSET4. In this example:

- The screening is enabled.
- The next screening function to perform is identified in table C7ALWOPC, if the value in field REFERNCE is SCRN.
- The link group ID is 10.
- The CCS500 log is activated with a threshold limit of 100 and a period of 5 min. If 100 or more MSUs are discarded within the 5-min period, a CCS500 log is generated.
- The CCS501 log is activated with a threshold limit of 100 and a period of 5 min. If 100 or more MSUs are received within the 5-min period, a CCS501 log is generated.
- The CCS502 log is activated with a threshold limit of 100 and a period of 5 min. When the number of messages from other networks reaches 100 during the 5-min period, one CCS502 log is generated, and no additional CCS502 logs are generated until the next period.
- The CCS503 log is activated with a threshold limit of 100 and a period of 5 min. When the number of errors within a screening function reach 100 during the 5-min period, one CCS503 log is generated, and no additional CCS503 logs are generated until the next period.

### MAP example for table C7GTWLKS

LINKSET	ENABLED					SCREEN	LINKGRP
MSUDSCRD	MSURECVD		SCRFAILS			SCRERROR	REMARKS
OPTIONS							
LNKSET4			Y			C7ALWOPC SCRN	(10)\$
Y	100	5	Y	100	5	Y 100 5	\$
	\$						

### Table history

#### TL11

References to HLIU and HSLR were added.

**STP04.0**

References to MDR7 screening were removed in STP04.0.

---

## C7ICCVCD

---

### Table name

International Credit Card Validation Called Party Address Table

### Functional description

Table C7ICCVCD provides the translation between internal identifiers and external addresses. The translation allows the system to measure and record the volume of signaling control connection part (SCCP) messages that pass through a switch.

The international credit card validation (ICCV) called party addresses against which to record appears in this table.

### Datafill sequence and meaning

You must enter data in table C7NETWRK before you enter data in table C7ICCVCD.

### Table size

1 to 128 tuples

### Datafill

Datafill for table C7ICCVCD appears in the following table

#### Field descriptions

Field	Subfield or refinement	Entry	Explanation and action
TUPLE		NATL or INTL	<i>Network type selector.</i> Enter the selector for the required network type. Enter NATL for national network, or INTL for international network.  The default value for this field is NATL.
KEY		1 to 64	<i>Called party address key.</i> Enter a number that identifies the ICCV called party address.  The default value for this field is 0 (zero).
ICCVCDPA		numeric (0 to 99999)	<i>Called party digit address.</i> Enter the called party address. Enter a maximum of 4 digits to specify a range of addresses.  The default value for this field is 0 (zero).

**C7ICCVCD** (end)**Datafill example**

Sample datafill for table C7ICCVCD appears in the following table.

**MAP example for table C7ICCVCD**

TUPLE	KEY	ICCVCDPA
NATL	1	12345

**Table history****BCS34**

Table C7ICCVCD was introduced in BCS34.

**Additional information**

This section provides information on credit card numbers. This section describes changing administrative numbers in table C7ICCVCD.

**Credit card number**

A credit card number is a string of digits. The first two digits are the industry identifier digits. The next five digits include the country code. These digits are the digits that you enter in the calling and called party address tables.

The system allows any number of digits to a maximum of five. If the entry has less than five digits, the entry is an address range. The system does not allow range overlaps. An entry of 123 matches 12345 and 1239. This entry is an example of range overlap. If 123 is a current entry, 12345 and 1239 cannot appear in the table. If 12345 is a current entry, 123 and 1239 cannot appear in the table.

**Modifying administrative numbers**

You cannot change tuples. To change a tuple, you must delete the tuple and perform a manual Device Independent Recording Package (DIRP) rotate. Add a new tuple with the correct entries.

If you attempt to add a new address with the same key as the key you deleted, the following error message appears:

```
Cannot add tuple, Manual DIRP rotate required
```

## C7ICCVCG

---

### Table name

International Credit Card Validation Calling Party Address

### Functional description

Table C7ICCVCG provides the translation between internal identifiers and external addresses. This translation allows the system to measure and record the volume of signaling control connection part (SCCP) messages. These SCCP messages pass through a switch.

This table specifies the calling party addresses for international credit card validation (ICCV) the system records against.

A credit card number contains a string of digits.

### Datafill sequence and meaning

You do not need to enter data before you enter data in table C7ICCVCG.

### Table size

1 to 256 tuples

### Datafill

Datafill for table C7ICCVCG appears in the following table.

#### Field descriptions (Sheet 1 of 2)

Field	Subfield or refinement	Entry	Explanation and action
TUPLE		IDG, IPC, NDG, or NPC	<i>Address type selector.</i> Enter the selector for the address type you require. The following are the address types: IDG (international digit), IPC (international point code), NDG (national digit), and NPC (national point code).  The default value for this field is NDG.



**C7ICCVCG** (continued)**Field descriptions (Sheet 2 of 2)**

Field	Subfield or refinement	Entry	Explanation and action
KEY		1 to 64	<i>Calling party address key.</i> Enter a number that identifies the ICCV calling party address.  The default value for this field is 0 (zero).
ICCVCGPA		0 to 99 999 for IDG or NDG 0 to 16 363 for IPC or NPC	<i>Calling party address.</i> Enter the calling party address. The format depends on the address type you select.  If the entry in field TUPLE is IDG or NDG, the correct range is 0 to 99999.  If the entry in field TUPLE is IPC or NPC, the correct range is 0 to 16363.  The default value for this field is 0 (zero).

**Datafill example**

Sample datafill for table C7ICCVCG appears in the following example.

**MAP example for table C7ICCVCG**

TUPLE	KEY	ICCVCGPA
NDG	1	12345

**Table history****BCS34**

Table C7ICCVCG was introduced in BCS34.

**Additional information**

This section provides information on credit card numbers and modifying administrative numbers in table C7ICCVCG.

**Credit card number**

A credit card number contains a string of digits. The first two digits are the industry identifier digits. The next five digits include the country code. These five digits are the digits you enter in the calling and called party address tables.

## **C7ICCVCG (end)**

---

The system allows a maximum of five digits. If you enter less than five digits, the entry is an address range. The system does not allow range overlaps. For example, an entry of 123 matches 12345 and 1239. If 123 is a current entry, the system does not allow 12345 and 1239 as table datafill. If 12345 is a current entry, the system does not allow 123 and 1239 as table datafill.

### **Changing administrative numbers**

You cannot change tuples. To modify a tuple, you must delete the tuple and perform a manual Device Independent Recording Package (DIRP) rotate. The addition of a new tuple that contains the correct entries occurs.

The operator can attempt to add a new address with the same key as the one that you deleted. When this condition occurs, the following error message appears:

```
Cannot add tuple, Manual DIRP rotate required
```

**C7ISL****Table name**

C7 ISDN User Part Signaling Loopback

**Functional description**

Table C7ISL allows an operating company to define the two endpoints that makeup an ISL (ISUP Signaling Loopback) facility. The purpose of table C7ISL is to identify those ISUP facilities with ISL capabilities, and provide the digital trunk controller 7 (DTC7) XPM with the additional information needed to properly route the associated signaling messages.

**Datafill sequence and implications**

Table C7ISL is provisioned after C7TRKMEM in addition to normal ISUP datafill.

**Table size**

Table C7ISL utilizes SEGMENTED STORE to dynamically expand and contract as needed. The capacity of table C7ISL parallels that of table C7TRKMEM, and relies on sizing restrictions/limitations already defined for table C7TRMEM.

**Datafill**

The following table lists datafill for table C7ISL.

**Datafill example**

The following example shows sample datafill for table C7ISL.

**MAP display example for table C7ISL**

TABLE: C7ISL	
ENDPT 1	ENDPT 2
ICISL 1	OGISL 1

**Table history****NA008**

Added table C7ISL.

## C7LINK

---

### Table name

CCS7 Link Table

### Functional description

Table C7LINK makes the association between the physical equipment of a link and the logical view of the link as a member of a set of links (a linkset). A link is composed of a signaling terminal (ST), transmission links (TL), and a message switch and buffers (MSB) and the logical view as a member of a set of links (a linkset).

*Note:* If office parameter USP\_ACTIVE\_IN\_NETWORK is set to Y, you cannot access information in this table. A message appears referring you to the Graphical User Interface on the Universal Signaling Point (USP) for proper administration of link data.

CCS7 links that are associated with signaling transfer point (STP) logical nodes can be located on any link peripheral processor (LPP). For DMS-Service Switching Point (SSP) or Integrated Node (INode) offices, SSP links can reside on any of the following platforms:

- link peripheral processor (LPP)
- DMS SuperNode SE link interface shelf (SNSE LIS)
- fiber link interface shelf (FLIS)

*Note 1:* All references to the STP apply to the INode unless otherwise specified.

*Note 2:* Throughout this document, LIU (link interface unit) is used to refer to Common Channel Signaling 7 link interface units (LIU7), ethernet link interface units (ELIU) high-speed link interface units (HLIU), multiple link interface units (MLIU) and high-speed link routers (HSLR).

Table C7TRKMEM increased its limit to 120960 tuples in TL13 software release. To enable the increased limit, table C7LINK and C7ROUTER must datafill only 32-Mbyte LIU7s. The value of field PROCPEC for the LIU7 in table LIUINV must be set to NTEX22CA.

### Datafill sequence and implications

The following tables must be datafilled before table C7LINK:

- C7NETWRK
- C7LKSET
- C7TIMER

**C7LINK** (continued)

- C7CNGSTN
- LIUINV
- STPOOLS
- STINV
- TRKMEM
- TRKGRP
- TRKSGRP
- ADJNODE
- CLLI

When provisioning HSL, datafill tables C7LKPARAM and CARRMTC.

**Table size**

Up to 108 tuples for a switch with the Nortel reduced instruction set computing (BRISC) processor

Up to 180 tuples for a switch with the BRISC processor if the following conditions are met:

- The software load is a World Trade or GSM product.
- There are no T1 digital trunk controllers (DTC) datafilled in table LTCINV (LIU7 external routing is not required).
- If T1 DTCs exist in table LTCINV, LIU7 external routing must be active.

**Datafill**

The following table lists datafill for table C7LINK.

**Field descriptions (Sheet 1 of 8)**

Field	Subfield	Entry	Explanation and action
LINKNAME		see subfields	<i>CCS7 link name</i>
	LINKSET	alphanumeric (1 to 16 characters)	<i>Linkset name</i> Enter the name of the linkset of which the link is a member. This linkset name must exist in table C7LKSET.

**C7LINK** (continued)**Field descriptions (Sheet 2 of 8)**

Field	Subfield	Entry	Explanation and action
	LINKSLC	0 to 15	<p><i>Signaling link number</i></p> <p>Enter a signaling link number to identify the link within the linkset. Subfields LINKSET and LINKSLC identify a particular link.</p> <p>The signaling link number must be the same at both ends of the linkset. The value in field LINKSLC in table C7LINK at opposing ends of the linkset must match. If the values in subfield LINKSLC do not match, the link cannot stabilize.</p> <p>Any links added to a linkset that is datafilled in table C7GTWLKS must have allocation scheme LIUBASIC and/or LIUCHANNEL. Gateway screening procedures are only supported on Common Channel Signaling 7 LIU7, HLIU and HSLR links.</p> <p>The only valid link indexes for Japan Public Networks 7 (JPN7) are 0 to 7.</p>
LINKDATA		see subfield	<p><i>Link data</i></p> <p>This field consists of subfield ALLOC.</p>

**C7LINK** (continued)**Field descriptions (Sheet 3 of 8)**

<b>Field</b>	<b>Subfield</b>	<b>Entry</b>	<b>Explanation and action</b>
	ALLOC	LIUBASIC, LIUCHANNEL, STBASIC STPOOL	<p><i>Allocation scheme</i></p> <p>This field contains the allocation scheme for the specified linkset.</p> <p>NTC7 links only support LIUBASIC, LIUPOOL, or LIUCHANNEL allocation schemes.</p> <p>If a link interface unit (LIU) is used to meet the throughput requirements of a signaling transfer point (STP), enter LIUBASIC and datafill subfields LIUTYPE and LIUNO.</p> <p>If a HSLR is used to provide link routing functionality, enter LIUBASIC.</p> <p><b>Note 1:</b> STBASIC and STPOOL are not supported entries on the DMS-INode switch, but they are visible options.</p> <p><b>Note 2:</b> Any link that belongs to a linkset datafilled in table C7GTWLKS must have an allocation scheme of LIUBASIC, LIUCHANNEL or both. Gateway screening procedures are only supported for LIU7/HSLR links.</p> <p>If the LIU channel provides the definition of the CCS7 signaling channel path, enter LIUCHANNEL and datafill subfields LIUTYPE, LIUNO, and TL.</p>

**C7LINK** (continued)

Field descriptions (Sheet 4 of 8)

Field	Subfield	Entry	Explanation and action
			<p>If both the signaling terminal (ST) and the transmission link (TL) are explicitly specified, enter STBASIC and datafill subfields STNO and TL.</p> <p>If the TL is specified and the ST is selected from the pool of STs, enter STPOOL and datafill subfields STPOOL and TL.</p> <p><b>Note:</b> For JPN7 networks, a validation is made to ensure that the value in field TF of table C7TIMER is in accordance with the value in field NUMFLAGS of table C7LKSET. JPN7 links only support LIUCHANNEL and LIUBASIC allocation schemes for signaling terminals. For channelized access, LIUCHANNEL must be used. The following equation is used to verify this restriction:</p> $tf = (\text{numflags} + 3) \vee 3$ <p>where</p> <p>tf is the flag count value from table C7TIMER</p> <p>numflags is the number of flags from table C7LKSET</p> <p>v is the positive integer value (greater than zero) that satisfies the equation</p>
	STNO	0 to 1023	<p><i>Signaling terminal number</i></p> <p>If the entry in field ALLOC is STBASIC, enter the ST number used for the link. This number is defined in table STINV.</p>
	STPOOL	0 to 14 or N	<p><i>Signaling terminal pool number</i></p> <p>If the entry in field ALLOC is STPOOL, enter the ST pool number to specify the pool of STs from which the reserved ST is selected for the link. The ST pool is defined in table STPOOL.</p>



**C7LINK** (continued)

## Field descriptions (Sheet 5 of 8)

Field	Subfield	Entry	Explanation and action
	TL	see subfields	<i>Transmission link</i>  This subfield consists of subfields CLLI and EXTRKNM. If the entry in field ALLOC is STBASIC, STPOOL, or LIUCHANNEL, datafill this subfield to specify the name of the digital trunk used to transmit data for the link. The specified trunk is used as the startup link.
	CLLI	alphanumeric (1 to 16 characters)	<i>Common language location identifier</i>  Enter the CLLI of the digital trunk used to transmit data for the link.
	EXTRKNM	0 to 9 999	<i>External trunk number</i>  Enter the external trunk number for the digital trunk that is specified in field CLLI.
	LIUTYPE	ELIU, HSLR, LIU7	<i>Link interface PM type</i>  Enter ELIU, HSLR, or LIU7 to specify the peripheral module (PM) type for the PM on which the LIU is mounted.  Enter ELIU if the ASU type is Ethernet link interface unit.  Enter HSLR if the ASU type is dual-link interface unit (DLIU).  Enter LIU7 if the ASU type is CCS7 link interface unit.
	LIUNO	0 to 511	<i>Link interface unit number</i>  Enter the number of the LIU. The LIU number must be datafilled in table LIUINV before datafilling this field.  Entries outside this range are invalid.
CLASDATA		see subfield	<i>Class data</i>  This field consists of subfield LINKCLAS.
	LINKCLAS	MTP2, SAAL	<i>Link class</i>  This field consists of subfields MTP2 and SAAL.
	MTP2	see subfields	<i>Message transfer part layer 2</i>  This field consists of subfield Q703_INDEX

**C7LINK** (continued)**Field descriptions (Sheet 6 of 8)**

<b>Field</b>	<b>Subfield</b>	<b>Entry</b>	<b>Explanation and action</b>
	Q703_INDEX	0 to 31	Enter the index number of the Q703 tuple in table C7TIMER that is used for this link.
	SAAL	see subfields	<i>Signaling ATM adaptation layer</i>  This field consists of subfields SAAL_INDEX, LKPARAM_INDEX, CARRMTC_INDEX, VPI, and VCI.
	SAAL_INDEX	0 to 31	Enter the index number of the SAAL tuple in table C7TIMER that is used for this link.
	LKPARAM_INDEX	0 to 31	Enter the index number of the SAAL tuple in table C7LKPARAM used for this link.
	CARRMTC_INDEX	character string	Enter the template number of the HLIU tuple in table CARRMTC used for this link.
	VPI	0 to 255	<i>Virtual path identifier</i>  Enter the value that identifies the virtual path for the connection of a high-speed link to an ATM network. The default value is 0.
	VCI	0 to 65535	<i>Virtual channel identifier</i>  Enter the value that identifies the virtual channel for the connection of a high-speed link to an ATM network. The default value is 5.
Q707		0 to 31	<i>Q707</i>  Enter the index number of the Q707 tuple in table C7TIMER that is used for this link.
LINKOPT		vector of up to 4 options	<i>Link options</i>  If fewer than two multiples are required, end the list with a \$.

**C7LINK** (continued)

## Field descriptions (Sheet 7 of 8)

Field	Subfield	Entry	Explanation and action
	OPTIONS	PCR MSBPCR SLMPR SUERM, or MLIU_CH	<p><i>Options</i></p> <p>If preventative cyclic retransmission (PCR) error correction is applied to the link, enter PCR and datafill subfield TLTIME. PCR can only be entered if CCS7 Preventative Cyclic Retransmission is present. This capability applies only to CCS7 signaling links using a LIU-type peripheral module that is restricted to the DMS-STP switch.</p> <p>If PCR error correction is used on the signaling terminal card of the message switch and buffer 7 (MSB7), enter MSBPCR and datafill subfield TLTIME. MSBPCR can only be entered if Preventative Cyclical Retransmission Error Correction is on MSB7. This capability applies only to the CCS7 signaling terminal card of an MSB7, and is restricted to a DMS-STP switch.</p> <p><b>Note:</b> MSB7 is not support on the DMS-INode switch.</p> <p>The basic error correction method applies if PCR error correction is not used.</p> <p>If the link is to be included in the signaling link marginal performance report, enter SLMPR. No additional data is required with this entry value. If Signaling Link Marginal Performance Report is present and SLMPR is not entered as an option, the link is not included in the report unless it exceeds one of the thresholds.</p> <p>To specify the signaling unit error rate value for the link, enter SUERM and datafill subfield SUERM. If the signaling unit error count exceeds the specified error rate threshold, the DMS takes down the links.</p> <p><b>Note:</b> Value MLIU_CH is functional in software release MMP-12. Subfield PORT_NUMBER is associated with value MLIU_CH. Value MLIU_CH is visible but does not affect functionality in software release TL11.</p>

**C7LINK** (continued)

## Field descriptions (Sheet 8 of 8)

Field	Subfield	Entry	Explanation and action
	PORT_ NUMBER	0 to 3	<i>Port number</i>  If the value in subfield OPTIONS is MLIU_CH, enter a value for the port number used by the link on the MLIU.
TLTIME		1 to 500	<i>Transmission link time</i>  This field only appears in table C7LINK if CCS7 Preventative Cyclical Retransmission is present and the entry in field OPTIONS is PCR, or if Preventative Cyclical Retransmission Facilities is on MSB7 and the entry in field OPTIONS is MSBPCR. Field TLTIME contains the time it takes to send a CCS7 message signaling unit (MSU) from one signaling point (SP) to another SP over a satellite transmission link.  Enter the time duration (in 100-ms units) between when an MSU leaves an LIU and when it reaches the LIU at the far end through a satellite. The value in field TLTIME is used to calculate the PCR threshold value (the number of unacknowledged bytes the ST transmits before retransmitting).
	SUERM	32 to 255	<i>Signaling unit error rate monitor</i>  If the value in field OPTIONS is SUERM, enter the signaling unit error rate threshold value for this link. The recommended range of values is 64 to 128.  An SUERM value lower than 64 is not recommended since this can cause higher sensitivity (lower tolerance) to errors. An SUERM value greater than 128 is not recommended since this can cause congested signaling links. In both cases, a message is generated to warn operating company personnel.  Link maintenance actions DEACT (deactivate) and ACT (activate) must be executed in order to make a change effective.  If the signaling unit error count exceeds the threshold, the DMS switch takes down the links.

**C7LINK** (continued)**Datafill example**

The following example shows sample datafill for table C7LINK.

**MAP display example for table C7LINK**

LINKNAME		LINKDATA			
Q703		Q707		LINKOPT	
C7LKSET1	0	LIUCHANNEL	LIU7 101	CCS7TL200	2
	0		0		
					\$
C7LKSET1	1	STBASIC	103	CCS7TL100	1
	0		0		
					\$
C7LKSET1	2	STBASIC	104	CCS7TL100	2
	0		0		
					\$
C7LKSET2	0	STBASIC	108	CCS7TL120	0
		MTP2	0	0	
					\$
C7LKSET2	1	STBASIC	109	CCS7TL120	1
		MTP2	0	0	
					\$
C7LKSET2	2	STBASIC	110	CCS7TL120	2
		MTP2	0	0	
					\$
C7LKSET3	0	LIUBASIC	HSLR 1	SAAL	0
			0	DEFAULT	0 5 0
					\$
C7C7LKSET3	1LKSET3 1	LIUBASIC	HSLR 2	SAAL	0
			0	DEFAULT	0 5 0
					\$
SSP1_LK	0	LIUCHANNEL	MLIU 25	CA_TRK	0
		MTP2	0		0
					\$

## C7LINK (continued)

---

### Supplementary information

This section provides information on error messages, restrictions, and dump and restore procedures for table C7LINK.

#### Adding a link

To add a link observe the following rules:

- The linkset specified must be listed in table C7LKSET.
- The link must be in the offline state when the fields are changed.
- If the allocation scheme is STBASIC, the ST number specified must be defined in table STINV and designated for CCS7 use.
- If the allocation scheme is STBASIC or STPOOL, the specified TL must be a defined trunk, not just a valid common language location identifier (CLLI).
- The signaling system 7 (SS7) must have a linkset type (field LSTYPE in table C7LKSET) of ALINK and an allocation scheme (field ALLOC in table C7LINK) of STBASIC or STPOOL. Assign these links to different digital trunk controllers (DTC) in table TRKMEM to provide redundancy. Failure to do this leads to an SS7 outage when the DTC goes out of service.
- If the allocation scheme is STPOOL, the ST pool must be defined for CCS7 use, the ST pool data must be valid, and the ST pool specified must be defined.
- If the allocation scheme is STBASIC, the ST must not already be reserved for use by another link.
- If the allocation scheme is STBASIC or STPOOL, the specified TL must not be allocated for use by another linkset.
- Any links added to a linkset that is datafilled in table C7GTWLKS must have an allocation scheme of LIUBASIC. Gateway screening procedures are supported only on LIU7 or HSLR-based links.
- Do not exceed the maximum of four HSLs per linkset.
- The link must be on the same MSB as the linkset to which this link is added.
- For all allocation schemes, the index specified in fields Q703 and Q707 must exist in table C7TIMER.

---

**C7LINK** (continued)

---

- For SSP or INode offices, LIU7 external routers must reside on any of the following platforms:
  - LPP, enhanced LPP (ELPP), fiberized LPP (FLPP)
  - SNSE LIS
  - FLIS
- For ITU and NTC7 networks, you can datafill more than 8 (up to 16) A, E, and F links, with the following restrictions:
  - The linkset to which you are adding the link is not a part of a combined linkset defined in table C7RTESET.
  - The linkset is not a member of a GTT equal cost result in table C7GTT.

**Maintaining redundancy**

If members of a linkset are mapped to the same MSB port and the connection is lost, the trunk goes down and causes an outage. It is, therefore, important to maintain redundancy.

To achieve redundancy, linksets must be distributed between ST cards that have different C-side port assignments. Check the C-side ports of the ST card to ensure that this criterion is met.

**Modifying a link**

To modify a link observe the following rules:

- The fields that can be modified are the fields that are prompted in association with the allocation scheme.
- If the allocation scheme is STBASIC, fields STNO, TL, Q703, and Q707 can be modified.
- If the allocation scheme is STPOOL, fields STPOOL, TL, Q703, and Q707 can be modified.
- If the allocation scheme is LIUBASIC, fields LIUTYPE, LIUNO, Q703, Q707, and LINKOPT can be modified. Options PCR and SLMPR only appear in field LINKOPT if CCS7 Preventative Cyclical Retransmission and Signaling Link Marginal Performance Report are present.
- Any link that belongs to a C7GTWLKS linkset cannot have its allocation scheme changed to anything other than LIUBASIC, LIUCHANNEL or both. Gateway screening procedures are supported only on LIU7-based links.

## C7LINK (continued)

---

- If a link is reassigned to a different linkset, delete it from the existing linkset and add it to the new linkset. The link is keyed on linkset name and link number. Keys cannot be modified.
- For all allocation schemes, the index specified in fields Q703 and Q707 must exist in table C7TIMER.

### Deleting a link

The linkset from which the link is deleted must be offline.

### Information message

If office parameter USP\_ACTIVE\_IN\_NETWORK is set to Y, you cannot access this table. The following message appears when you try:

```
*****
**                               ACCESS DENIED                               **
*****
**                               **
** The USP is now used to administer the SS7 data. **
** SS7 linksets and links now only exist on the USP. **
** There is no information to display for this table. **
**                               **
** Go to the GUI on the USP to access this data. **
*****
```

### Error messages

Error messages may be produced due to the constraints on the number of links in a linkset of a given linkset type. These error messages are described in the following text.

The maximum number of links in a linkset is four in networks AUSTR7 and CCITT7 with an LSTYPE of BLINK or DLINK. The maximum number of links with an LSTYPE of CLINK is eight in both networks. If the link being added exceeds the maximum number of links allowable for the LSTYPE, the tuple is rejected and the following error message is displayed:

No more than 4 HSLs can be datafilled per linkset.

**Note:** LSTYPE is defined in table C7LKSET.

The maximum number of links in a linkset is eight in network ANSI7 with an LSTYPE of BLINK, CLINK, or DLINK. The maximum number of links in a linkset is also eight in network AUSTR7 with an LSTYPE of ALINK, ELINK, or FLINK. If the link being added exceeds the maximum number of links



---

**C7LINK** (continued)

---

allowable for the LSTYPE, the tuple is rejected and the following error message is displayed:

```
LINKSET WOULD EXCEED THE MAXIMUM OF 8 LINKS FOR THE LSTYPE  
SELECTED.
```

The maximum number of links in a linkset is 16 in networks ITU and NTC7 with an LSTYPE of ALINK, ELINK, or FLINK. The system displays error messages when:

- you try to datafill more than eight links, and the indicated linkset is a member of a combined linkset (equal cost route defined in table C7RTESET). The following message appears:

```
LINKSET belongs to combined routing and would exceed link  
limit of 8 for this LSTYPE. Check table C7RTESET for equal  
cost route.
```

- you try to datafill more than eight links, and the indicated linkset is a member of an equal cost result defined in table C7GTT. The following message appears:

```
LINKSET belongs to equal cost GT result and would exceed link  
limit of 8 for this LSTYPE. Check table C7GTT for equal cost  
result.
```

If the 8-bit SLS signaling link selector (SLS) functionality is activated, the maximum number of links in a linkset is 16, if the network type is ANSI7 and the LSTYPE is BLINK, CLINK, or DLINK. If the link being added causes the maximum number of allowable links for the LSTYPE to be exceeded, the tuple is rejected and the following error message is displayed:

```
LINKSET WOULD EXCEED THE MAXIMUM OF 16 LINKS FOR THE LSTYPE  
SELECTED.
```

World Trade and GSM software loads increase the maximum number of links that can be datafilled in an SSP or INode office from 108 to 180 (refer to feature AU3246 and 59009996). The next error message applies to the World Trade and GSM software load only.

The following error message appears, when you attempt to datafill more than 108 links in table C7LINK when table LTCINV contains T1 DTC datafill and LIU7 external routing is not active:

```
FAILED: Can not add link because DTC datafilled in table LTCINV.  
Activate LIU7 external routing and remove MTP databases or  
remove DTC datafill to be able to add greater than 108 links.
```

**C7LINK** (continued)

If the value in table C7TIMER subfield SAALT3 or the value in table C7LKPARM subfield RPDU is too low, the following error message appears:

EXCESSIVE PROVING PDU RATE

The following parameter relationship has been violated for one or more links using this tuple:  $\{100\ 000 / c7timer-saal-t3\} * 1.2 \leq c7lkparm-rpdu$  100 000 is a unit conversion factor 1.2 provides a 20% safety margin

The error message includes an algebraic formula, in which:

- c7timer-saal-t3 indicates the value in table C7TIMER, parameter SAALT3.
- c7lkparm-rpdu indicates the value in table C7LKPARM, parameter RPDU.

To clear the error message increase one or both of the values. The following table indicates suggested values for each field.

**Suggested values for parameters SAALT3 in table C7TIMER and RPDU in table C7LKPARM**

C7TIMER-SAALT3	C7LKPARM-RPDU
90 - recommended value	1680 - recommended value
90	1335 to 1680
72 to 2300	1680
90 to 2300	1400

If the value in table C7TIMER subfield SAALT2 is too low or if the values in table C7TIMER subfield SAALT3 and table C7LKPARM subfield SSCFN1 are too high, the following error message appears:

EXCESSIVE PROVING TIME

The following parameter relationship has been violated for one or more links using this tuple:  $\{c7timer-saal-t3 * c7lkparm-sscfn1 * 1.2\} / 10\ 000 \leq c7timer-saal-t2$  10 000 is a unit conversion factor 1.2 provides a 20% safety margin

**C7LINK** (continued)

The error message includes an algebraic formula, in which:

- c7timer-saal-t3 indicates the value in table C7TIMER, parameter SAALT3.
- c7lkparm-sscf1 indicates the value in table C7LKPARM, parameter SSCFN1.
- c7timer-saal-t2 indicates the value in table C7TIMER, parameter SAALT2.

To clear the error message do one or more of the following:

- increase the value in table C7TIMER subfield SAALT2
- decrease the value of table C7TIMER subfield SAALT3
- decrease the value of table C7LKPARM subfield SSCFN1

The following table indicates suggested values for each field.

**Suggested values for parameters SAAL73 in table C7TIMER, SSCFN1 in table C7LKPARM, and SAALT2 in table C7TIMER**

C7TIMER-SAALT3	C7LKPARM-SSCFN1	C7TIMER-SAALT2
90 - recommended value	6250 - recommended value	120 - recommended value
90	6250	70 to 180
90	50 to 6250	120
90 to 160	6250	120

The system allows a manual verification of the value in the VCI field.

The system displays the following error messages when there is no entry in the VCI field:

```
Warning: VCI value missing, must be datafilled in the range: 0
- 65535.
```

The system displays the following error message if the value you enter in the VPI field is beyond the range of 0 to 255:

```
*** ERROR ***

TYPE OF VPI IS VPI_RANGE

TYPE IS VPI_RANGE {0 TO 255}
```

## **C7LINK** (end)

---

VPI:0

The system displays the following message if the value you enter in the VCI field is beyond the range of 0 to 65535:

VCI must be between 0 and 65535.

When table C7TRKMEM contains more than 100000 entries, it requires links in table C7LINK to use 32-Mbyte LIU7s. Any change operation on an existing link in table C7LINK must not change the LIU7 used by the link to a non-32-Mbyte LIU7. The system displays the following error message if the above conditions are violated:

The current number of ISUP Circuits is <number>. This link will not be able to support this. Please remove tuples from table C7TRKMEM before making this change to this table.

**C7LKPARM****Table name**

Common Channel Signaling 7 Link Parameter Table

**Functional description**

Table C7LKPARM contains the CCS7 link parameter values used in a single data structure and applied to multiple links in a class that have the same characteristics. Table C7LKPARM only contains datafill for CCS7 links with a signaling ATM adaptation layer (SAAL).

**Datafill sequence and implications**

There is no requirement to datafill other tables prior to table C7LKPARM.

**Table size**

32 tuples

**Datafill**

The following table lists datafill for table C7LKPARM.

**Field descriptions (Sheet 1 of 3)**

Field	Subfield or refinement	Entry	Explanation and action
LKPRMKEY			<i>Link parameter key</i> This field consists of subfields TYPE and ID.
	TYPE	SAAL	<i>Link protocol type</i> Enter the SAAL for the link protocol type.
	ID	0 to 31	<i>Unique link identifier</i> Enter the unique link identifier.
MAXCC		1 to 10	<i>Maximum value for VT(CC)</i> Enter the maximum value for the transmitter state variable (VT) connection control (CC) count in protocol data units (PDU). The default value is 4.
MAXPD		5 to 2120	<i>Maximum value for VT(PD)</i> Enter the maximum value for VT poll data (PD) count in PDUs. The default value is 500.

**C7LKPARM** (continued)

## Field descriptions (Sheet 2 of 3)

Field	Subfield or refinement	Entry	Explanation and action
MAXSTAT		3 to 1021	<p><i>Maximum list elements in STAT PDU</i></p> <p>Enter the maximum list elements in STAT PDU.</p> <p>The default value is 67.</p>
SSCFN1		50 to 6250	<p><i>PDU's sent during normal proving</i></p> <p>Enter the number of PDU's sent during normal proving.</p> <p>Enter the limit in units of 10.</p> <p>The default value is 6250 (62500 PDU's).</p>
MAXNRP		1 to 10	<p><i>Failed proving attempt threshold</i></p> <p>Enter the failed proving attempt threshold in terms of retransmitted messages.</p> <p>The default value is 1.</p>
ISERMALP		0 to 1000	<p><i>Exponential smoothing factor</i></p> <p>Enter the exponential smoothing factor.</p> <p>Enter the limit in units of .001.</p> <p>The default value is 100 (exponential smoothing factor .1).</p>
ISERMTHR		0 to 1000	<p><i>Quality of service threshold</i></p> <p>Enter the quality of service threshold.</p> <p>Enter the limit in units of .001.</p> <p>The default value is 244 (quality of service threshold .244)</p>
ISERMN		1 to 25	<p><i>Number of monitoring intervals</i></p> <p>Enter the number of monitoring intervals.</p> <p>The default value is 9.</p>
ISERMNBK		1 to 10	<p><i>Monitoring intervals per block</i></p> <p>Enter the number of monitoring intervals per block.</p> <p>The default value is 3.</p>

**C7LKPARM** (continued)

## Field descriptions (Sheet 3 of 3)

Field	Subfield or refinement	Entry	Explanation and action
RPDU		1 to 1680	<p><i>Rate in messages per second</i></p> <p>Enter the rate in messages per second for flow controlling received messages.</p> <p>The default value is 1680.</p> <p><b>Note:</b> For a signaling connection control part (SCCP) linkset, the range is 1 to 1400.</p>
FLOWBC		1 to 5	<p><i>Poll frequency using fixed credit flow control</i></p> <p>Enter the poll frequency used to update credit.</p> <p>The default value is 2.</p> <p><b>Note:</b> Nortel recommends using the default value. If you use any other value, the optimal operation of the link can be affected.</p>

**Datafill example**

The following example shows sample datafill for table C7LKPARM.

**MAP display example for table C7LKPARM**

```

LKPRMKEY MAXCC MAXPD MAXSTAT SSCFN1 MAXNRP ISERMALP
ISERMTHR ISERMN ISERMNBK RPDU FLOWBC
-----
SAAL 0      4    500      67    500      1      100
      244      9      3    1680      2

```

**Table history****TL11**

Removed datafill restrictions. Added error messages.

**TL10**

Updated default value for field RPDU.

**C7LKPARAM** (continued)**TL07**

Table C7LKPARAM was introduced.

**Supplementary information****Error messages**

If the value in table C7TIMER subfield SAALT3 or the value in table C7LKPARAM subfield RPDU is too low, the following error message appears:

EXCESSIVE PROVING PDU RATE

The following parameter relationship has been violated for one or more links using this tuple:  $\{100\ 000 / c7timer-saal-t3\} * 1.2 \leq c7lkparm-rpdu$  100 000 is a unit conversion factor 1.2 provides a 20% safety margin

The error message includes an algebraic formula, in which:

- c7timer-saal-t3 indicates the value in table C7TIMER, parameter SAALT3.
- c7lkparm-rpdu indicates the value in table C7LKPARAM, parameter RPDU.

To clear the error message increase one or both of the values. The following table indicates suggested values for each field.

**Suggested values for parameters SAALT3 in table C7TIMER and RPDU in table C7LKPARAM**

<b>C7TIMER-SAALT3</b>	<b>C7LKPARAM-RPDU</b>
90 - recommended value	1680 - recommended value
90	1335 to 1680
72 to 2300	1680
90 to 2300	1400

If the value in table C7TIMER subfield SAALT2 is too low or if the values in table C7TIMER subfield SAALT3 and table C7LKPARAM subfield SSCFN1 are too high, the following error message appears:

EXCESSIVE PROVING TIME

The following parameter relationship has been violated for one or more links using this tuple:  $\{c7timer-saal-t3 * c7lkparm-sscf1 * 1.2\} / 10\ 000 \leq c7timer-saal-t2$  10 000 is a unit conversion factor 1.2 provides a 20% safety margin



**C7LKPARM** (end)

The error message includes an algebraic formula, in which:

- c7timer-saal-t3 indicates the value in table C7TIMER, parameter SAALT3.
- c7lkparm-sscfn1 indicates the value in table C7LKPARM, parameter SSCFN1.
- c7timer-saal-t2 indicates the value in table C7TIMER, parameter SAALT2.

To clear the error message do one or more of the following:

- increase the value in table C7TIMER subfield SAALT2
- decrease the value of table C7TIMER subfield SAALT3
- decrease the value of table C7LKPARM subfield SSCFN1

The following table indicates suggested values for each field.

**Suggested values for parameters SAAL73 in table C7TIMER, SSCFN1 in table C7LKPARM, and SAALT2 in table C7TIMER**

<b>C7TIMER-SAALT3</b>	<b>C7LKPARM-SSCFN1</b>	<b>C7TIMER-SAALT2</b>
90 - recommended value	6250 - recommended value	120 - recommended value
90	6250	70 to 180
90	50 to 6250	120
90 to 160	6250	120

## C7LKSET

---

### Table name

CCS7 Linkset Table

### Functional description

Table C7LKSET defines the characteristics of a linkset. A linkset is a set of links grouped to provide one logical path between adjacent nodes. Each link carries traffic between the origination point code and a far-end point code. The table also defines attributes that are common to all links in the linkset. Individual links are defined in table C7LINK.

*Note:* If office parameter USP\_ACTIVE\_IN\_NETWORK is set to Y, you cannot access information in this table. A message appears referring you to the Graphical User Interface (GUI) on the Universal Signaling Point (USP) for access to data for this table.

Linksets are identified by name and type, and by the point code of the far-end switching unit. Each tuple in table C7RTESET has a destination point code (DPC) which identifies the final destination of the route in the network.

Signaling, Engineering, and Administration System (SEAS) specifies that the linkset's far end must also have an identifier. The identifier is specified in field FECLLI and is for SEAS use only.

### Linkset types

The following figure shows linkset types.

## Linkset types

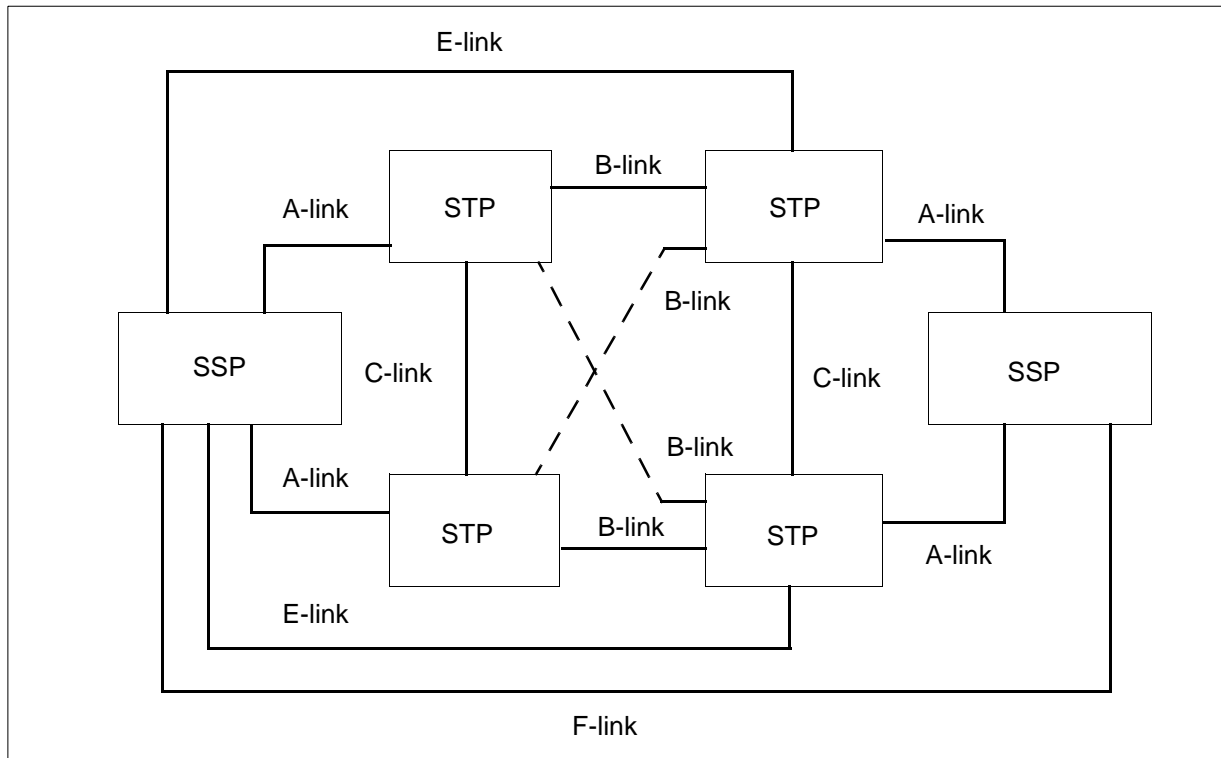

The link connections shown in the above figure are as follows:

- A-links (access links) connect service switching points (SSP) to home signal transfer points (STP).
- B-links (bridge links) connect STP pairs of the same level.
- C-links (cross links) connect STPs to mate STPs.
- D-links (diagonal links) connect primary to regional STPs (not shown).
- E-links (extended links) connect SSPs to remote STPs.
- F-links (fully associated links) connect SSPs.

### Adding a linkset

To add a new linkset to table C7LKSET, table C7NETWRK must be datafilled with a valid network name to which the linkset is assigned.

To add a linkset, the following additional information is required:

- linkset name
- linkset type
- type of network to which the linkset is added
- far-end point code (FEPC)

- far-end common language location identifier (FECLLI)
- whether the signaling link test is performed at periodic test intervals
- whether the routeset test is run when the linkset first goes into service
- whether the inhibit test is run if any link is inhibited
- index to the tuple in the Q704 timer set in table C7TIMER
- congestion index
- number of flags sent between consecutive signaling units (SU)
- whether message transfer part (MTP) restart is enabled or disabled
- whether the network indicator interworking functionality is enabled or disabled
- whether the automatic inhibiting functionality is enabled or disabled

### **Modifying a linkset**

The linkset must be offline in order to modify most of the fields. Only the MTPRES, NIRPLMT, and AUTOINH fields can be modified when the linkset is in service.

Field NETNAME (network name) cannot be modified.

### **Deleting a linkset**

To delete a linkset, follow the procedure outlined below:

1. Ensure that the linkset is offline.
2. Remove the linkset from all routesets that are defined in table C7RTESET with the linkset as a member.
3. Delete all links in the linkset. See table C7LINK for information about deleting a link.
4. If the linkset is assigned a destination in table C7LSDEST, delete this destination assignment.
5. If the linkset exists in table C7LSUSMT, delete the tuple with that linkset from table C7LSUSMT.
6. Using the linkset name to identify it, delete the linkset.

### **Datafill sequence and meaning**

The following tables must be datafilled before table C7LKSET:

- C7CNGSTN
- C7TIMER
- C7NETWRK

Delete datafill from table C7LSUSMT before deleting a linkset value from table C7LKSET.

### Table size

0 to 511 tuples

The size of table C7LKSET is dynamically allocated.

### Datafill

The following table lists datafill for table C7LKSET.

#### Field descriptions

Field	Subfield	Entry	Explanation and action
LINKSET		see subfield	<i>Linkset key</i> This field, which is the key to table C7LKSET, consists of subfield NAME.
	NAME	alphanumeric (1 to 16 characters)	<i>Linkset name</i> Enter the name of the linkset. A CCS7 linkset name can be all numeric characters. For example, a network can have the name of 99 999. This affects MAP-level commands.  To post a numerically named linkset at the appropriate MAP level, the name must be enclosed in single quotation marks ( ` ` ). For numerically named linksets longer than seven characters, no quotation marks are required. For example, linkset name 12345678 does not require quotation marks to be posted at the MAP level.  If STP SEAS is present in the load, the entry in this field must be eight characters.

## Field descriptions

Field	Subfield	Entry	Explanation and action
LSTYPE		ALINK, BLINK, CLINK, DLINK, ELINK, or FLINK	<p><i>Linkset type</i></p> <p>This field describes the position of the linkset in the North American CCS7 network architecture.</p> <p>The LSTYPE entry value, which depends on the type of CCS7 node that lies on either end of this linkset, indicates whether the linkset connects two end offices, two STPs, two mated STPs, or an end office and an STP. Figure 1 in the previous “Functional description” section illustrates these linkset types.</p> <p>Enter ALINK (access link) to specify a linkset that connects an SSP to a home STP.</p> <p>Enter BLINK (bridge link) to specify a linkset that connects STP pairs of the same level.</p> <p>Enter CLINK (cross link) to specify a linkset that connects an STP to a mate STP.</p> <p>Enter DLINK (diagonal link) to specify a linkset that connects a primary STP to a regional STP.</p> <p>Enter ELINK (extended link) to specify a linkset that connects an SSP to a remote STP.</p> <p>Enter FLINK (fully associated link) to specify a linkset that connects SSPs.</p> <p>For SSP switching units, use ALINK, ELINK, or FLINK linkset types.</p> <p>For Japan Public Network 7 (JPN7) networks, use ALINK or ELINK linkset types. While ALINK is the typical choice, ELINK can be used to help offset inter-STP traffic. FLINK is for internal testing purposes only and is not supported for operating company usage.</p>
NETNAME		alphanumeric (1 to 16 characters)	<p><i>Network name</i></p> <p>This field identifies the network to which the linkset belongs. Enter a common language network name as defined in table C7NETWRK.</p>

## Field descriptions

Field	Subfield	Entry	Explanation and action
FEPC		see subfields	<p><i>Far-end point code</i></p> <p>This subfield, which specifies the point code at the other end of the linkset, consists of subfield NETTYPE and its refinements. The refinements make up the point code for the specified network type.</p> <p><b>Note:</b> The far-end point code (FEPC) of the linkset must differ from the point code (PTCODE) of the network to which the linkset belongs. This PTCODE is found by comparing the NETNAME in table C7LKSET with the same NETNAME in table C7NETWRK.</p>
	NETTYPE	ANSI7, CCITT7, NTC7, JPN7, TTC7	<p><i>Network type</i></p> <p>If the network type is the North American variant, enter ANSI7 and datafill refinements NETWORK, CLUSTER, and MEMBER.</p> <p>If the network type is the international variant, enter CCITT7 and datafill refinement FORMAT and its associated subfield.</p> <p>If the network type is the NTC7 variant, enter NTC7 and datafill subfield PC.</p> <p>If the network type is Telecommunication Technology Committee Signaling System 7, enter TTC7 and datafill refinements MAINAREA, SUBAREA, and AREAUNIT.</p> <p>If the network type is Japan Public Network 7, enter JPN7 and datafill refinements MAINAREA, SUBAREA, and AREAUNIT.</p>

**NETTYPE = ANSI7**

If the entry in subfield NETTYPE is ANSI7, datafill the refinements NETWORK, CLUSTER and MEMBER.

**Field descriptions for conditional datafill**

Field	Subfield	Entry	Explanation and action
	NETWORK	0 to 255	<i>Network identifier</i> Enter the number of the network identifier that is assigned to the far-end switching unit of the specified network.
	CLUSTER	0 to 255	<i>Cluster identifier</i> Enter the number of the network identifier cluster that is assigned to the far-end switching unit of the specified network.
	MEMBER	0 to 255	<i>Member</i> Enter the number of the cluster member that is assigned to the far-end switching unit of the specified network.



**NETTYPE = CCITT7**

If the entry in subfield NETTYPE is CCITT7, datafill the subfield FORMAT and its refinements.

**Field descriptions for conditional datafill**

Field	Subfield	Entry	Explanation and action
	FORMAT	AUSTRIA, BASIC, CHINA, GERMAN, INTL, INTL2, or TURK	<p><i>CCITT format</i></p> <p>This field specifies the CCITT7 point code refinements that are required for the network.</p> <p>If the point code used is for Austria, enter AUSTRIA and datafill refinements ZONE, REGION, and SIGPOINT.</p> <p>If the point code used is based on one field, enter BASIC and datafill refinement PC.</p> <p>If the point code used is for China, enter CHINA and datafill refinements ZONE, EXCHANGE, and SIGPOINT.</p> <p>If the point code used is for Germany, enter GERMAN and datafill refinements NUMAREA, HVST, KVST and SIGPOINT.</p> <p>If the point code used is international, enter INTL and datafill refinements ZONE, AREANETW, and SIGPOINT.</p> <p>If the point code used is international-2 with a 4-3-4-3 bit format, enter INTL2 and datafill refinements NETWORK, REGION, GROUP, and MEMBER.</p> <p>If the point code used is for Turkey with a 4-3-7 bit format, enter TURK and datafill refinements ZONE, REGION, and SIGPOINT.</p>

## Field descriptions for conditional datafill

Field	Subfield	Entry	Explanation and action
	ZONE	0 to 31	<p><i>Zone identifier</i></p> <p>Enter the zone identifier assigned to the far-end switching unit for the specified network.</p> <p>If the entry in subfield FORMAT is AUSTRIA, the range is 0 to 31.</p> <p>If entry in subfield FORMAT is CHINA, the range is 0 to 15.</p> <p>If the entry in subfield FORMAT is INTL, the range is 0 to 7.</p> <p>If the entry in subfield FORMAT is TURK, the range is 0 to 15.</p>
	AREANETW	0 to 255	<p><i>Area/network identifier</i></p> <p>If the entry in subfield FORMAT is INTL, enter the number of the area/network identifier in the zone that has been assigned to the far-end switching unit for the specified network.</p>
	REGION	0 to 15	<p><i>Region</i></p> <p>If the entry in subfield FORMAT is AUSTRIA, enter the number of the region that has been assigned to the far-end switching unit for the specified network.</p> <p>If the entry in subfield FORMAT is TURK, the range is 0 to 7.</p>
	EXCHANGE	0 to 127	<p><i>Exchange</i></p> <p>If the entry in subfield FORMAT is CHINA, enter the number of the exchange in the zone that has been assigned to the far-end switching unit for the specified network.</p>
	NUMAREA	00 to 15	<p><i>Numbering Area</i></p> <p>If the entry in subfield FORMAT is GERMAN, enter the area number assigned to the office.</p>
	HVST	0 to 7	<p><i>HVSt Area</i></p> <p>If the entry in subfield FORMAT is GERMAN, enter the HVSt number assigned to the office.</p>

## Field descriptions for conditional datafill

Field	Subfield	Entry	Explanation and action
	KVST	00 to 15	<p><i>KVSt Area</i></p> <p>If the entry in subfield FORMAT is GERMAN, enter the KVSt number assigned to the office.</p>
	SIGPOINT	0 to 127	<p><i>Signal point identifier</i></p> <p>If the entry in subfield FORMAT is INTL, enter the number of the signal point in the area/network identifier that has been assigned to the far-end switching unit for the specified network. The range is 0 to 7.</p> <p>If the entry in subfield FORMAT is AUSTRIA, enter the number of the signal point in the region that has been assigned to the far-end switching unit for the specified network. The range is 0 to 31.</p> <p>If the entry in subfield FORMAT is CHINA, enter the number of the signal point in the exchange that has been assigned to the far-end switching unit for the specified network. The range is 0 to 7.</p> <p>If the entry in subfield FORMAT is TURK, the range is 0 to 127.</p> <p>If the entry in subfield FORMAT is GERMAN, enter the number of the signal point in the exchange that has been assigned to the far-end switching unit for the specified network. The range is 0 to 7.</p>
	NETWORK	0 to 15	<p><i>Network</i></p> <p>If the entry in subfield FORMAT is INTL2, enter the network assigned to the office.</p>
	REGION	0 to 7	<p><i>Region</i></p> <p>If the entry in subfield FORMAT is INTL2, enter the network assigned to this office.</p>
	GROUP	0 to 15	<p><i>Group</i></p> <p>If the entry in subfield FORMAT is INTL2, enter the group assigned to the office.</p>

---

**Field descriptions for conditional datafill**

<b>Field</b>	<b>Subfield</b>	<b>Entry</b>	<b>Explanation and action</b>
	MEMBER	0 to 7	<i>Member</i>  If the entry in subfield FORMAT is INTL2, enter a numeric value between 0 and 7 for the member assigned to the destination office for the specified network.
	PC	0 to 16383	<i>Point code</i>  If the entry in subfield FORMAT is BASIC, enter the number of the FEPC that has been assigned to the far-end switching unit for the specified network.

**NETTYPE = NTC7**

If the entry in subfield NETTYPE is NTC7, datafill the refinements NMAINAREA, NSUBAREA, and NSIGPOINT.

**Field descriptions for conditional datafill**

Field	Subfield	Entry	Explanation and action
	NMAINAREA, NSUBAREA, NSIGPOINT	0 to 255	<p><i>Point code</i></p> <p>This subfield is a vector of up to three values that make up the point code (PC) for the destination. This vector must be unique within the specified network.</p> <p><b>Note:</b> This field is different from the PC field that applies to CCITT7 networks with a CCITT format of BASIC.</p> <p>NMAINAREA corresponds to the main area that is assigned to the office and the specified network.</p> <p>NSUBAREA corresponds to the subarea in the main area that is assigned to the office and the specified network.</p> <p>NSIGPOINT corresponds to the area unit in the subarea that is assigned to the office and the specified network.</p> <p>Enter one, two, or three values to specify the PC vector. If the field contains one or two values, the vector must be terminated by a \$. If the field contains three values (a full PC combination), a \$ is not needed to end the vector. Each entry must be separated from the next by a blank space.</p>

**NETTYPE = JPN7 or TTC7**

If the entry in subfield NETTYPE is TTC7 or JPN7, datafill the refinements MAINAREA, SUBAREA, and AREAUNIT.

**Field descriptions for conditional datafill**

Field	Subfield	Entry	Explanation and action
	MAINAREA	0 to 31	<i>Main area</i> Enter the number of the main area that has been assigned to the far-end switching unit for the specified network.
	SUBAREA	0 to 15	<i>Subarea</i> Enter the number of the subarea of the main area that has been assigned to the far-end switching unit for the specified network.
	AREAUNIT	0 to 127	<i>Area unit</i> Enter the number of the area unit in the subarea assigned to the far-end switching unit for the specified network.

**For all NETTYPE values**

For all subfield NETTYPE values, datafill the fields FECLLI, SIGLKTST, RSTEST, INHTEST, Q704, CNGSTN, NUMFLAGS, and MTPRES.

For all subfield NETTYPE values, datafill the fields SIGLKTST, RSTEST, INHTEST, Q704, CNGSTN, CONGENH, NUMFLAGS, MTPRES, and CHNGSLs.

### Field descriptions

Field	Subfield	Entry	Explanation and action
FECLLI		alphanumeric (1 to 16 characters)	<p><i>Far-end common language location identifier</i></p> <p>This field is for SEAS use only. If STP SEAS-Operations is present in the load, the entry in field FECLLI must be exactly 11 characters.</p> <p>Enter the common language location identifier (CLLI) of the switching unit at the far end of the linkset.</p>
SIGLKTST		Y or N	<p><i>Signaling link test</i></p> <p>Enter Y if a signaling link test (SLT) is to be sent out periodically on each in-service link in the linkset. It is recommended that this field be set to Y.</p> <p>Enter N if this process is not required.</p> <p>For JPN7 linksets, this field must be set to N.</p> <p><b>Note:</b> All SIGLKTST tuples in C7LKSET must be set to Y when activating or deactivating the SLT feature with software optionality control (SOC). For more information on SOC, refer to the <i>Software Optionality Control User Guide</i>.</p>
RSTEST		Y or N	<p><i>Routeset test</i></p> <p>This field specifies whether the routeset test runs when a linkset in a routeset becomes available for traffic.</p> <p>Enter Y if a routeset test must be performed on routesets that use this linkset (when the linkset goes into service). Otherwise, enter N.</p> <p>For JPN7 linksets, and for CCITT7 networks used in Australia, this field must be set to N.</p>

## Field descriptions

Field	Subfield	Entry	Explanation and action
INHTEST		Y or N	<p><i>Inhibit test</i></p> <p>This field specifies whether the inhibit test runs when any link is inhibited. The inhibit test audits the inhibit indicators at either end of a linkset and corrects any inconsistencies.</p> <p>Enter Y if the inhibit test is required to run when any link is inhibited.</p> <p>This field must be set to N for the following:</p> <ul style="list-style-type: none"> <li>• NTC7 networks</li> <li>• CCITT7 networks used in Australia</li> <li>• JPN7 linksets</li> </ul> <p>Otherwise enter N (the default value).</p>
Q704		0 to 31	<p><i>Q704 timer index</i></p> <p>Enter the index of the table C7TIMER tuple that defines the Q704 timers used for this linkset.</p>
CNGSTN		0 to 63	<p><i>Congestion index</i></p> <p>Enter the index of the table C7CNGSTN tuple that defines the congestion thresholds used by this linkset.</p>
NUMFLAGS		1 to 255	<p><i>Number of flags sent between consecutive signaling units</i></p> <p>Enter a numeric value to specify the number of flags that are sent between consecutive signaling units. This value is inversely proportional to the rate at which message signaling signal units are sent over any one link. A lower rate of signal unit transmission results in a decreased load on the far-end signaling terminal since the total amount of traffic that can be carried over the link is reduced.</p>



## Field descriptions

Field	Subfield	Entry	Explanation and action
			<p>Far-end signaling terminals (ST) cannot always cope with all offered traffic. The sending of multiple flags is a throttling mechanism that reduces the load on an ST. This is an engineering issue that must be controlled by the far-end ST capability.</p> <p>The default value for this field is 1, which sends a single flag between consecutive signaling units. This value preserves the behavior of existing data. For CCITT7 networks that are used in Australia, this field is usually set to 1 and must never be greater than 32.</p>
MTPRES		Y or N	<p><i>MTP restart</i></p> <p>Enter Y to activate the MTP restart procedure for network type ANSI7, CCITT7 or NTC7. Otherwise, enter N.</p> <p>The default value is Y.</p> <p>Enter N for network types TTC7 and JPN7. If operating company personnel attempt to add value Y, the following message appears.</p> <p><code>MTP Restart is not supported for TTC7 or JPN7 networks. MTPRES must be set to N.</code></p> <p><b>Note:</b> If an MTP restart procedure is in progress, the changed value for field MTPRES takes effect after the completion of the in-progress MTP restart procedure. The following message is issued:</p> <p><code>If an MTP Restart procedure is in progress, the modified control parameter shall be effective at the completion of that procedure.</code></p>
CHNGSLS		N	<p>This field was created for feature enhancements and is not currently used. The default is N.</p> <p><b>Note:</b> The STP SEAS ADD_LS command automatically sets CHNGSLS to N.</p>

## Field descriptions

Field	Subfield	Entry	Explanation and action
SCCPONLY		Y or N	<p><i>SCCP traffic only traffic type present on the linkset</i></p> <p>If SCCP traffic is the only traffic type present on the linkset, enter Y. If other types of traffic are present, enter N.</p> <p><b>Note:</b> The STP SEAS ADD_LS command automatically sets CHNGSLS to N.</p>
SUFFLNKS		<p>0 to 16 (for ANSI STP nodes)</p> <p>1 (for non-ANSI STP nodes)</p>	<p><i>Sufficient links</i></p> <p>This field indicates the number of available links considered sufficient to declare the routeset available.</p> <p>For ANSI STP nodes, the default value is the number of links in the linkset divided by 2 (50%). An entry of 0 (zero) represents the default value.</p> <p>If the number entered in this field is greater than the number of links in the linkset, the system uses the default value.</p> <p>For non-ANSI and non-STP nodes, the only valid entry is 1.</p>
NIRPLMT		NIL, INTL, INTLSPARE, NATL, or NATLSPARE	<p><i>Network indicator replacement</i></p> <p>This field indicates whether the network indicator (NI) interworking function is enabled or disabled.</p> <p>Activate the network indicator interworking function by setting SOC option TEL00015 to ON.</p> <p>When the function is activated, the value in the NIRPLMT field indicates the replacement NI that the selected linkset uses.</p> <p>Enter INTL, INTLSPARE, NATL, or NATLSPARE to activate the network indicator replacement function on the selected linkset.</p>

**Field descriptions**

Field	Subfield	Entry	Explanation and action
			<p>The default value is NIL. Enter NIL to disable the network indicator replacement function on the selected linkset.</p> <p>When you activate the function, the system performs the following functions:</p> <ul style="list-style-type: none"><li>• The entry in field NIRPLMT replaces the existing NI of the outgoing messages on the selected linkset.</li><li>• The MTP discrimination function uses the entry in field NIRPLMT for the incoming messages on the selected linkset.</li><li>• When the incoming message carries the same NI as the entry in field NIRPLMT, the system converts the incoming message NI to the original NI datafilled in table C7NETWRK.</li></ul>

**Field descriptions**

<b>Field</b>	<b>Subfield</b>	<b>Entry</b>	<b>Explanation and action</b>
AUTOINH		Y, N	<p><i>Automatic inhibiting</i></p> <p>This field indicates whether the automatic inhibiting function is enabled or disabled.</p> <p>Enter Y to activate the automatic inhibiting function on the selected linkset.</p> <p>Enter N to turn off the automatic inhibiting function on the selected linkset.</p> <p>The default value is Y.</p> <p>After the automatic inhibiting function is activated, the ManB (manual busy) command puts any link, except the last one on the linkset, into local inhibit state.</p>
CONGENH		Y, N	<p><i>Congestion enhancement</i></p> <p>Enter N to disable the false link enhancements detailed below.</p> <p>Enter Y for the false link congestion enhancements to change the existing false link detection algorithm for that linkset. This adds a proving period before the congestion is reported to the reset of the route-set.</p> <p>The proving period is in the range 10 seconds to 2 minutes and is set by T31 timer in table C7TIMER. During the proving period the other links are monitored and if another link goes into congestion, the congestion state is immediately reported to the upper layers. If no congestion is detected on any other links during this timeframe, the LIU7 belonging to that link restarts to clear up any local problems, temporarily taking down the link. Normal operation is resumed when the LIU7 recovers.</p> <p>The default value for the CONGENH field is Y.</p> <p>This field is applicable to ANSI linksets only.</p>

**Datafill example**

The following example shows sample datafill for table C7LKSET.

This example is datafilled in accordance with the following requirements:

- two linksets: C7LKSET4 and C7LKSET5
- linkset type is FLINK
- network name for C7LKSET4 is C7NETWRK4
- network name for C7LKSET5 is C7NETWRK1
- FEPC for C7LKSET4 is ANSI7 4 5 6
- FEPC for C7LKSET5 is ANSI7 74 75 76
- far-end CLLI for C7LKSET4 is C7LKSET4
- far-end CLLI for C7LKSET5 is C7LKSET5
- the signaling link test is disabled
- routeset test is disabled for both linksets
- inhibit test is disabled for both linksets
- index for the Q704 timer in table C7TIMER is 0 (zero)
- congestion index is 0 (zero) for both linksets
- number of flags between consecutive signal units is 1
- MTP restart is enabled for both linksets
- SCCP is not the only traffic on both linksets
- NIRPLMT for C7LKSET4 is NIL
- NIRPLMT for C7LKSET5 is NATL
- Automatic inhibiting function is disabled for C7LKSET4
- Automatic inhibiting function is enabled for C7LKSET5

## Map display for table C7LKSET

LINKSET	LSTYPE	NETNAME	FECLLI	SIGLKTST	RSTEST	INHTEST	FEPC
			Q704	CNGSTN	NUMFLAGS	MTPRES	CHNGSLS
							SCCPONLY
							NIRPLMT
AUTOINH							
-----							
C7LKSET4	FLINK	C7NETWRK4				ANSI7	4 5 6
		C7LKSET4		N		Y	N
		0	0		1	Y	N
							N
							NIL
N							
C7LKSET5	FLINK	C7NETWRK5				ANSI7	74 75 76
		C7LKSET5		N		Y	N
		0	0		1	Y	N
							N
							NATL
Y							

## Table history

**CSP18/SN05**

Added field CONGENH for feature 19013269 to enhance False Congestion Controls for North American SSP markets using ANSI signaling.

**MMP15**

Format TURK added for feature 59022376.

**MSH14**

Message added to direct the user to the GUI on the USP for access to table data when office parameter USP\_ACTIVE\_IN\_NETWORK is set to Y.

**STP05**

Added fields NIRPLMT and AUTOINH for feature 19007803, Network Indicator Interworking. Expanded table size from 255 to 511 tuples for feature 19007799, Linkset Expansion to 432.

**STP04.1**

Added format INTL2 and the following refinements: NETWORK, REGION, GROUP, and MEMBER.

Added field SUFFLINKS.

**STP04.0**

Added field SCCPONLY.

**TL06**

Added error messages.

**TL05**

Added field MTPRES.

**Supplementary information**

This section provides information on datafilling table C7LKSET for specific applications, and product descriptive information related to table C7LKSET.

**Restrictions if SEAS is present in load**

If STP SEAS is present in the load, the following restrictions apply:

- The linkset name (field LINKSET) must be exactly eight characters. If it is not, the tuple is rejected and the following error message is displayed:

Example of a MAP display:

```
SEAS IS PRESENT ON THE STP. LINKSET CLLI MUST BE 8
CHARACTERS. FECLLI MUST BE 11 CHARACTERS.
```

- The name of the office on the far end of the linkset (field FECLLI) must be exactly 11 characters. If it is not, the tuple is rejected and the following error message is displayed:

Example of a MAP display:

```
SEAS IS PRESENT ON THE STP. LINKSET CLLI MUST BE 8
CHARACTERS. FECLLI MUST BE 11 CHARACTERS.
```

**Information message**

If office parameter USP\_ACTIVE\_IN\_NETWORK is set to Y, the system displays the following message when you try to access this table:

```
*****
**                                ACCESS DENIED                                **
*****
**                                **
** The USP is now used to administer the SS7 data **
** SS7 linksets and links only exist on the USP. **
** There is no information to display for this table.**
**                                **
** Go to the GUI on the USP to access this data. **
*****
```

**Error messages**

If the node type datafilled in table C7NETWRK is not an STP, then B, C, or D links cannot be added to the linkset tuple. The following error message is displayed:

```
LinkSet cannot be Type B, Type C or Type D.
```

If the node type datafilled in table C7NETWRK is either an STP or an SSP/STP, linkset tuples that contain F links cannot be added. The following error message is displayed:

```
LinkSet cannot be Type F.
```

If you try to delete a linkset, and tuples in table C7LSUSMT are using that linkset value, the following error message displays:

```
Error: The linkset is still in use in table C7LSUSMT
```



**C7LOCSSN****Table name**

CCS7 Local Subsystem Table

**Functional description**

Table provides information for the local subsystem. Table C7LOCSSN includes traffic mix information (TFMI) requirements, replication information, an adjacent intermediate node translator list (AINODES), and a concerned node list (PCNAMES).

For related information, refer to table C7NETSSN.

**Datafill sequence and implications**

Table C7NETSSN must be datafilled before table C7LOCSSN.

Replicated PCs must be datafilled in table C7NETSSN with a corresponding subsystem entry. PC names in either the AINODES or PCNAMES lists must be datafilled in C7NETSSN.

**Table size**

0 to 253 tuples

Memory is dynamically allocated.

**Datafill**

The following table lists datafill for table C7LOCSSN.

**Field descriptions (Sheet 1 of 5)**

Field	Subfield or refinement	Entry	Explanation and action
SSNAME		alphanumeric (1 to 8 characters)	<i>Subsystem name</i> The user of a signaling connection control part (SCCP) is known as a subsystem. Enter one of the pre-defined or user-defined subsystem names. The meanings of the predefined subsystem names are described below.
		ACCS	Enter ACCS to specify the automatic calling card service subsystem.
		ACCTSS	Enter ACCTSS to specify the account code validation subsystem.

**C7LOCSSN** (continued)**Field descriptions (Sheet 2 of 5)**

<b>Field</b>	<b>Subfield or refinement</b>	<b>Entry</b>	<b>Explanation and action</b>
		AIN01	Enter AIN01 to specify the advanced intelligent network (AIN) 0.1 messaging subsystem.
		AUTHSS	Enter AUTHSS to specify the authcode verification subsystem.
		BNS	Enter BNS to specify the billing number screening subsystem.
		CMS	Enter CMS to specify the call management service subsystem.
		CNAMD	Enter CNAMD to specify the Custom Local Area Signaling Service (CLASS) Calling Name Delivery (CNAMD) subsystem.
		E800	Enter E800 to specify the enhanced 800 service subsystem.
		ETSIIN	Enter ETSIIN to specify the European Telecommunications Standards Institute intelligent network subsystem.  This entry is also valid for Capability Set 1 Refined (CS-1R) on the DMS-100 service switching point (DMS-SSP).
		INTERWRK	Enter INTERWRK to specify the subsystem that is used for features that are interworked between PRA and SS7.
		ISDNSS	Enter ISDNSS to specify ETSI ISDN supplementary services.
		ISDNUP	Enter ISDNUP to specify the ISDN user part subsystem.
		MAPMSC	Enter MAPMSC to specify the mobile application part mobile switching center.
		NMS	Enter NMS to specify the network message service subsystem. In BCS30, this subsystem name is only used by the network message waiting indicator.

**C7LOCSSN** (continued)**Field descriptions (Sheet 3 of 5)**

<b>Field</b>	<b>Subfield or refinement</b>	<b>Entry</b>	<b>Explanation and action</b>
		NSSTCN	Enter NSSTCN to specify the network services software (NSS) travel card number subsystem.
		N00	Enter N00 to specify the N00 calling service subsystem.
		OAM	Enter OAM to specify the operations, administration, and maintenance subsystem.
		PRA	Enter PRA to specify the primary rate access subsystem. This subsystem allows Network Ring Again (NRAG) on primary rate access (ISDN PRA).
		PVN	Enter PVN to specify the private virtual network subsystem.
		REPLDIGS	Enter REPLDIGS to specify the NSS DBCP replace dialed digits application subsystem.
		SCPACCS	Enter SCPACCS to specify the ACCS database (SCP) subsystem.
		SCPBNS	Enter SCPBNS to specify the BNS database (SCP) subsystem.
		SCPE800	Enter SCPE800 to specify the E800 database (SCP) subsystem.
		TCN	Enter TCN to specify the travel card service subsystem.
		TOPSLNP	Enter TOPSLNP to specify the TOPS local number portability subsystem.
		TUP	Enter TUP to specify the telephone user part subsystem.
		800P	Enter 800P to specify the 800 Plus subsystem, which is the Canadian version of CCS7 800 service. 800P is provided if feature package NTX555 (800 Plus) is in the switching unit. Otherwise, E800 is provided.

**C7LOCSSN** (continued)

## Field descriptions (Sheet 4 of 5)

Field	Subfield or refinement	Entry	Explanation and action
SSNUMBER		numeric (0 to 255)	<p><i>Subsystem number</i> Enter a numeric value for the subsystem number at the specified PC. The subsystem number must be unique within table C7LOCSSN. Entries outside the 2 to 254 range are not valid.</p> <p>Enter 2 for subsystem TUP. Enter 3 for subsystem ISDNUP Enter 4 for subsystem OAM Enter 106 for subsystem ETSIIN</p>
MININST		numeric (1 to 32)	<p><i>Minimum number of instances</i> Enter a numeric value to specify the minimum number of instances of a local subsystem that must be available (in service) to provide normal service. The value is used to determine the aggregate status of the subsystem.</p>
REPLINFO		see subfield	<p><i>Replicate information</i> This field consists of subfield REPLFLAG.</p>
	REPLFLAG	Y or N	<p><i>Replication flag</i> If there is a replicated subsystem for the local subsystem, enter Y (yes) and datafill refinement PCNAME. If there is no replicated subsystem, enter N (no).</p>
	PCNAME	alphanumeric	<p><i>Point code name</i> If the entry in field REPLFLAG is Y, enter the point code CLLI for the replicated subsystem in the CCS7 network. The subsystem name must be datafilled for this PC in table C7NETSSN.</p>
TFMI		see subfield	<p><i>Traffic mix information</i> This field consists of subfield TFMI.</p>

**C7LOCSSN** (continued)**Field descriptions (Sheet 5 of 5)**

Field	Subfield or refinement	Entry	Explanation and action
	TFMI	Y or N	<i>Traffic mix information flag</i> If traffic mix information is required by the local subsystem, enter Y and datafill refinement AINODES. If traffic mix information is not required, enter N.
	AINODES	vector of up to 8 PCs	<i>Adjacent intermediate node translator list</i> This refinement, which is only datafilled if the entry in field TFMI is Y, is a vector of eight adjacent PC names. A node is adjacent if it is the last node to do a full translation to the local subsystem. Each entry must be separated from the next by a blank space. Each PC must be datafilled in table C7NETSSN.
PCNAMES		vector of up to 64 PCs	<i>Concerned node list</i> This field, which is a vector of up to 64 PC names, lists the nodes that are informed of status changes at the local subsystem. By default, all adjacent intermediate node translators are concerned nodes and are not required to appear in this list.  All concerned nodes that are not in the AINODES list must be included in this vector. The PCs for these nodes must be datafilled in table C7NETSSN.

**Datafill example**

The following example shows sample datafill for table C7LOCSSN.

In this example, subsystem number 120 in the AIN subsystem is defined as having a minimum instance value of 4, a replicated subsystem with a PC of SCP3, no required traffic mix information, and a concerned node list that consists of PC name SSP1.

**C7LOCSSN** (continued)**MAP display example for table C7LOCSSN**

SSNAME	SSNUMBER	MININST	REPLINFO	TFMI	PCNAMES
AIN	120	4	Y SCP3	N	SSP1\$

**Supplementary information**

This section provides additional information on datafilling table C7LOCSSN.

**Adding a tuple to table C7LOCSSN**

To add a local subsystem, the following information is required:

- The local subsystem name, which must be valid, must be specified. For valid subsystem names, see the entries for field SSNAME. A subsystem can only be datafilled if its software package has been installed in the switching unit.
- The subsystem number must be specified. This entry value must be unique within table C7LOCSSN.
- The minimum instance value must be specified. This is the number of instances of the local subsystem that must be in service to provide normal service.
- If the local subsystem is replicated, a point code (PC) for the location of the replicate must be supplied. Replicate information must be datafilled in table C7NETSSN and cannot exist in table C7RPLSSN for this subsystem. Replicate information can be in either the AINODES list or PCNAMES (a concerned node list).
- Traffic mix information (TFMI) must be specified if it is required by the local subsystem, in which case a list of adjacent intermediate node translators (AINODES) must be supplied. The PCs in the AINODES list must be datafilled in table C7NETSSN. The list must be unique.
- A concerned node list (PCNAMES) must be specified. This list identifies the nodes that are informed of status changes at the local subsystem. All PCs in this list must be datafilled in table C7NETSSN. The list must be unique and cannot contain any PCs from the AINODES list.

---

**C7LOCSSN** (end)

---

**Modifying a tuple in table C7LOCSSN**

Table C7LOCSSN fields that can be modified are listed below.

- The subsystem number can be modified when the subsystem is offline (OFFL). The subsystem numbers for TUP, ISDNUP, and OAM cannot be changed.
- The minimum instance value can be modified.
- The replication information can be modified. Whether or not the subsystem is replicated, the PC can be changed if it is replicated.
- The traffic mix information (TFMI) flag can be modified.
- The adjacent intermediate node translator (AINODES) list can be increased by adding new PC names to the list. List items can be deleted by repeating unchanged entries and leaving out the undesired entries.
- PCNAMES (a concerned node list) can be changed in the same manner that the AINODES list is modified.

**Deleting a tuple from table C7LOCSSN**

To delete a tuple, the following conditions must be met:

- The subsystem must be offline (OFFL).
- No global title translations in table C7GTT can result in this subsystem.

**Table History****APC008.1**

Entry ETSIIN is also valid for CS-1R on the DMS-SSP.

**APC008**

Feature AU2342 added entry ETSIIN to field SSNAME.

**TOPS07**

Value TOPSLNP added to field SSNAME by feature AF6549.

**EUR006**

Adds the entry ISDNSS to the field SSNAME to specify ETSI ISDN supplementary services.

## C7NETSSN

---

### Table name

CCS7 Network Subsystem Routing table

### Functional description

Table C7NETSSN provides the set of remote point codes (PC) and subsystems at the remote PCs, where messages are routed by the signaling connection control part (SCCP). A PC is a node in the CCS7 network that may be a service switching point (SSP), a signaling transfer point (STP), or a service control point (SCP or database). SCCP routes messages to subsystems at the PC, including SCCP management (SCMG) or SCCP itself, for further global title (GT) translation.

If an STP routeset is unavailable with the MNA7 INode, node isolation on the STP side of the switch is prevented by allowing GTT alternate routing through an available SSP routeset. Table C7NETSSN must be datafilled with identical STP and SSP routesets for this to occur, even when the alternate routeset is not datafilled as a GTT result.

### Adding a point code or subsystems to table C7NETSSN

To add a PC to table C7NETSSN (with or without subsystems), the following information is required:

- the PC name CLLI. Routing information for the PC must be datafilled in table C7RTESET.
- extended unit data indicator (XUDTIND). The XUDTIND capability indicator is required on remote nodes that perform global title translation (GTT). The indicator allows STPs to verify if the remote node can process an extended unit data (XUDT) / extended unit data service (XUDTS) message.
- the congestion timer CGT1, activated when the congestion increases
- the congestion timer CGT2, activated when the congestion decreases
- a list of subsystems present at the PC. This list can be nil (\$) since no subsystem name is required for an STP PCNAME. Otherwise, each symbolic ID can be either a member of predefined range of subsystems or a user defined subsystem name and a number. Each list item consists of a subsystem name (SSNAME) and its associated subsystem number (SSNUMBER). The list of subsystem names and numbers must be unique at this PC. If telephone user part (TUP) is specified, the subsystem number must be 2. If integrated services digital network user part (ISDNUP) is specified, the subsystem number must be 3. If operations, administration, and maintenance (OAM) is specified, the subsystem number must be 4.



---

**C7NETSSN** (continued)

---

**Modifying a point code or subsystem in table C7NETSSN**

The list of subsystems may be altered. Enter a new list of subsystems, repeating those that have not changed, and add any new subsystems. The subsystem names and numbers must be unique at the PC. You can also modify field XUPTIND. Enter Y or N as required, depending on the network configuration.

Any subsystems deleted from the list must not be replicated and must be offline (OFFL). If a subsystem is a member of a replicate pair in table C7RPLSSN, the operating company personnel are notified that table C7RPLSSN must be altered. The tuple containing the subsystem as a member of a replicate pair must be deleted or modified. Unchanged subsystems in the list are not affected.

The subsystem numbers for TUP, ISDNUP, and OAM cannot be changed.

*Note:* When adding custom local area signaling services (CLASS) functionality, the CCS7 links must first be busied at a MAP (maintenance and administration position) terminal. After completing the datafill, return the CCS7 links to service so that the CLASS feature can function.

**Deleting a point code or subsystem from table C7NETSSN**

Deletion is allowed if the following conditions are satisfied:

- The PC and all of its subsystems are OFFL at a MAP terminal.
- There are no global title translations (GTT) in table C7GTT that result in this PC or any of its subsystems.

If global title translations exist, the office personnel are informed, and are required to change the results of the translations before attempting to remove the PC or subsystems.

- None of the subsystems being deleted can be replicated.

If a subsystem is a member of a replicate pair in table C7RPLSSN, a warning is issued that table C7RPLSSN must be altered. The tuple

## C7NETSSN (continued)

---

containing the subsystem as a member of a replicate pair must be deleted or modified.



### **CAUTION**

#### **Loss of service**

Deletions from table C7NETSSN can affect table MSGRTE. The PC name (field PCNAME in table C7NETSSN) must not be referenced in table MSGRTE before deleting the tuple from table C7NETSSN. Failure to delete the PC name from table MSGRTE before table C7NETSSN results in message routing failure and can affect call processing.

If deleting tuples from table C7NETSSN, ensure that the PC name (field PCNAME in table C7NETSSN) is not referenced by table MSGRTE. If the PC name is referenced in table MSGRTE by an SS7 message route selector, the reference must be removed from table MSGRTE prior to deleting the C7NETSSN tuple.

Failure to delete the PC name reference from table MSGRTE, either by changing to a different PC name or by deleting the tuple entirely, results in invalid tuples being left in table MSGRTE after the referenced tuple is deleting in table C7NETSSN. An attempt to use an invalid tuple message routing results in message routing failure and can impact call processing.

If the PC name is referenced in table C7LOCSSN or C7RSSCRN, the reference must be removed before the tuple can be deleted.

### **Datafill sequence and implications**

Table C7RTESET must be datafilled before table C7NETSSN.

### **Table size**

Up to 2047 tuples

**C7NETSSN** (continued)**Datafill**

The following table lists datafill for table C7NETSSN.

**Field descriptions (Sheet 1 of 6)**

<b>Field</b>	<b>Subfield or refinement</b>	<b>Entry</b>	<b>Explanation and action</b>
PCNAME		alphanumeric (1 to 16 characters)	<i>Point code name</i> Enter a PC common language identifier (CLLI) defined by the operating company to identify a PC in the CCS7 network. Routing information for this PC must be datafilled in table C7RTESET. This CLLI corresponds to the remote PC where the subsystems are located.
XUDTIND		Y or N	<i>Extended unit data indicator</i> Enter Y (yes) to indicate that the remote node can support XUDT/XUDTS message types. Enter N (no) to indicate that the remote node cannot support XUDT/XUDTS message types.  The default value is Y.

**C7NETSSN** (continued)

## Field descriptions (Sheet 2 of 6)

Field	Subfield or refinement	Entry	Explanation and action
CGT1		0 to 31	<p><i>Congestion timer CGT1</i></p> <p>Enter an integer that starts the timer when the congestion is rising. Each integer represents 1 s.</p> <p>Timer CGT1 and an internal timer of 5 s specify the time during which the system discards all messages with the priority level lower than the internal congestion level. When the congestion level is higher than 1, and no transfer control (TFC) or message transfer part (MTP) messages arrive during the CGT1 plus 5 s period, the level of congestion decreases and timer CGT2 starts.</p> <p>The default value is 0, which deactivates this field. The recommended value is 2.</p> <p><b>Note 1:</b> The entries in fields CGT1 and CGT2 must both be either 0 or both other than 0.</p> <p><b>Note 2:</b> This field applies to ITU networks only. For all other networks, the only valid entry is 0, which deactivates the ITU SCCP Congestion Control feature.</p>

**C7NETSSN** (continued)

## Field descriptions (Sheet 3 of 6)

Field	Subfield or refinement	Entry	Explanation and action
CGT2		0 to 31	<p><i>Congestion timer CGT2</i> Enter an integer that starts the congestion timer when the congestion is decreasing. Each integer represents 1 s.</p> <p>When this timer expires, the internal timer of 5 s starts and the congestion level increases or decreases, depending on the reception or lack of reception of TFC or MTP messages. When the congestion level changes to 0, normal operation of a node starts.</p> <p>The default value is 0, which deactivates this field. The recommended value is 1.</p> <p><b>Note 1:</b> The entries in fields CGT1 and CGT2 must both be either 0 or both other than 0.</p> <p><b>Note 2:</b> This field applies to ITU networks only. For all other networks, the only valid entry is 0, which deactivates the ITU SCCP Congestion Control feature.</p>
SSNAMES		see subfields	<p><i>Subsystem names and numbers</i> This field is a vector of up to 27 multiples of subfields SSNAME and SSNUMBER. Separate each entry in the vector by a blank space and enter \$ (dollar sign) to indicate the end of the vector. Where the vector is nil, leave the subfields blank and enter \$.</p> <p><b>Note:</b> For STP and SSP routesets datafilled with the same destination, GTT alternate routing requires that this field be identical for both tuples.</p>

**C7NETSSN** (continued)

## Field descriptions (Sheet 4 of 6)

Field	Subfield or refinement	Entry	Explanation and action
	SSNAME	ACCS, ACCTSS, AIN01, AIN02, AUTHSS, BNS, CMS (see note), E800, ISDNUP, MAPHLR, NSSTCN, N00, OAM, OLNS, REPLDIGS, RTRS, SCPACCS, SCPBNS, SCPE800, TCN, TOPSLNP, TUP800P, or blank	<p><i>Subsystem name</i></p> <p>Enter one of the predefined or user-defined subsystem names, as described below. The subsystem names can be from one to eight characters in length.</p> <p>Enter ACCS for automated calling card service.</p> <p>Enter ACCTSS for account code validation.</p> <p>Enter AIN01 for advanced intelligent network (AIN) messaging subsystem.</p> <p>Enter AIN02 for advanced intelligent network (AIN) messaging subsystem.</p> <p>Enter AUTHSS for authcode verification.</p> <p>Enter BNS for billed number service.</p> <p>Enter CMS for call management service.</p> <p><b>Note:</b> Canada only</p> <p>Enter E800 for Enhanced 800 Service.</p> <p>Enter ISDNUP for ISDN user part.</p> <p>Enter MAPHLR for destination HLR.</p> <p>Enter NSSTCN for network service software travel card number.</p>

**C7NETSSN** (continued)**Field descriptions (Sheet 5 of 6)**

Field	Subfield or refinement	Entry	Explanation and action
			<p>Enter N00 for N00 calling service.</p> <p>Enter OAM for operations, administration, and maintenance.</p> <p>Enter OLNS for Originating Line Number Screening</p> <p>Enter REPLDIGS for NSS DBCP replace dialed digits.</p> <p>Enter RTRS for TOPS Real-Time Rating System.</p> <p>Enter SCPACCS for ACCS database (SCP).</p> <p>Enter SCPBNS for BNS database (SCP).</p> <p>Enter SCPE800 for E800 database (SCP).</p> <p>Enter TCN for travel card service.</p> <p>Enter TOPSLNP for TOPS Local Number Portability</p> <p>Enter TUP for telephone user part.</p> <p>Enter 800P for the Canadian version of CCS7 800 Service (800 Plus). 800P is provided if package X555 is in the switch. Otherwise, E800 is provided.</p> <p><b>Note:</b> For DMS-300 switches, leave field SSNAME blank.</p>

## C7NETSSN (continued)

### Field descriptions (Sheet 6 of 6)

Field	Subfield or refinement	Entry	Explanation and action
	SSNUMBER	2 to 254	<p><i>Subsystem number</i></p> <p>Enter the subsystem number at this PC. The subsystem number must be unique within table C7LOCSSN.</p> <p>If TUP is specified, the subsystem number must be 2.</p> <p>If ISDNUP is specified, the subsystem number must be 3.</p> <p>If OAM is specified, the subsystem number must be 4.</p> <p>Entries outside this range are invalid.</p> <p><b>Note:</b> For DMS-300 switches, leave field SSNUMBER blank.</p>

### Datafill example

The following example shows sample datafill for table C7NETSSN.

### MAP display example for table C7NETSSN

PCNAME	XUdTIND	CGT1	CGT2	SSNAMES
SSP1	Y	0	0	(ANI01 120) \$
ANSIRTSABC	N	0	0	(NETRAG 8) \$
ANSIRTSCBA	Y	0	0	(NETRAG 8) \$
CONG_RS3	Y	2	1	(SUB1 56) \$

### Table history

#### CSP14

Feature 59019374 adds fields CGT1 and CGT2.

#### CSP12

Feature 59009743 expands table C7NETSSN from 256 tuples to 2047 tuples.

#### CSP10

Field XUdTIND added to C7NETSSN by feature AU3082.



---

**C7NETSSN** (end)

---

**NA007**

Value AIN02 added to field SSNAME by feature AJ4099.

Value TOPSLNP added to field SSNAME by feature AF6549 in functionality TOPS LNP, OSEA0008.

**CSP06**

Value OLNS added to field SSNAME by feature AN1564 in functionality TOPS OLNS Interface, ABS00012. Added GTT alternate routing information to functional description and note to SSNAMES field (feature AG5085).

**CSP04**

Added value RTRS to field SSNAME according to feature AN1504 in functionality External RTRS Interface, ENSV0009

**UK002**

Entry MAPHLR was added to field SSNAME.

**CSP02**

A caution note was added regarding the danger of deleting tuples in table C7NETSSN without first deleting the referenced point code name in table MSGRTE.

**BCS36**

Entry AIN01 was added to field SSNAME.

---

## C7NETWRK

---

### Table name

CCS7 Network Table

### Functional description

Table C7NETWRK describes the signaling networks in use in a switching office. Data in table C7NETWRK defines the identity of all routesets in the switching office, with reference to network information. Common Channel Signaling 7 (CCS7) software uses this information to respond to changes in specifications between different network types. Many other CCS7 tables depend on the data in this table.

*Note:* When office parameter USP\_ACTIVE\_IN\_NETWORK is set to Y, the system displays table information, but does not allow the use of the DMS table editor to add, delete, or change a tuple in this table. If attempts are made to access this table, a message is generated referring the user to the Graphical User Interface (GUI) on the Universal Signaling Point (USP) for proper access to data for table C7NETWRK.

Field NETNAME (network name) is the key to table C7NETWRK. For each network and network type, the originating point code (OPC) of the office and the network indicator (NI) are specified. Each NI can have multiple signaling transfer point (STP) nodes datafilled. The STP point codes that have the same NI can have different network types.

Table C7NETWRK describes network options. The options specify the number of congestion levels used. The options also specify if signaling link selection (SLS) rotation is a part of the routing function, and if the transfer-restricted protocol is a part of the messaging protocol in the network.

Multiple CCS7 network address (MNA7) capability supports message transfer part (MTP) and signaling connection control part (SCCP) specifically for the DMS-STP/SSP Integrated Node (DMS-INode).

### Datafill sequence and meaning

Table C7TIMER must be datafilled before table C7NETWRK.

There is no requirement to datafill network names in table CLLI before using them in table C7NETWRK.

### Table size

0 to 16 tuples

## Datafill

The following table lists datafill for table C7NETWRK.

### Field descriptions

Field	Subfield	Entry	Explanation and action
NETNAME		alphanumeric (1 to 16 characters)	<p><i>Network name</i></p> <p>This field, which is the key to table C7NETWRK, contains the name of the defined network. Enter a network name that is unique to the switching office. This name can be up to 16 characters. An 11-character restriction applies under the following conditions outlined below:</p> <p>If STP-SEAS (Signaling, Engineering and Administration System) is present in the load, the entry in this field must be exactly 11 characters.</p> <p>If the network being datafilled has a field NI value of NATL and a field NETTYPE value of ANSI7, then the entry in field NETNAME must consist of the last 11 characters of office parameter SEAS_UAL_STP_NODE_NAME in table OFCENG.</p>
NODE TYPE		SSP, STP, SCP, SCP_STP, SCP_SSP_STP, SCP_SSP, or SSP_STP	<p><i>Node_type</i></p> <p>This field indicates the node functionality for the tuple entry.</p>
PTCODE		see subfield	<p><i>Office point code</i></p> <p>This field, which defines the address of the office in the network, consists of subfield NETTYPE and its refinements. Subfield NETTYPE specifies the type of network. The NETTYPE refinements specify a unique originating point code (OPC) in the network.</p>

**Field descriptions**

Field	Subfield	Entry	Explanation and action
	NETTYPE	ANSI7, CCITT7, JPN7, NTC7, TTC7	<p><i>Network type</i></p> <p>The value of the network type subfield determines which refinements specify the OPC for the network.</p> <p>If the network type is the North American variant, enter ANSI7 and datafill refinements NETWORK, CLUSTER, and MEMBER.</p> <p>If the network type is the international variant, enter CCITT7 and datafill refinement FORMAT.</p> <p>If the network type is the Japanese Public Network 7 variant, enter JPN7 and datafill refinements MAINAREA, SUBAREA, and AREAUNIT.</p> <p>If the network type is the NTC7 variant, enter NTC7 and datafill subfields NMAINAREA, NSUBAREA, and NSIGPOINT.</p> <p>If the network type is the Telecommunication Technology Committee System 7, enter TTC7 and datafill refinements MAINAREA, SUBAREA, and AREAUNIT.</p> <p>STP point codes with the same NI can have different network types.</p>

**NETTYPE = ANSI7**

If the entry in subfield NETTYPE is ANSI7, datafill refinements NETWORK, CLUSTER, and MEMBER.

**Field descriptions for conditional datafill**

Field	Subfield	Entry	Explanation and action
	NETWORK	0 to 255	<p><i>Network identifier</i></p> <p>Enter the network identifier assigned to the office for the specified network.</p>
	CLUSTER	0 to 255	<p><i>Cluster</i></p> <p>Enter the number of the cluster in the network assigned to the office for the specified network.</p>
	MEMBER	0 to 255	<p><i>Member</i></p> <p>Enter the number of the member in the cluster assigned to the office for the specified network.</p>

**NETTYPE = CCITT7**

If the entry in subfield NETTYPE is CCITT7, datafill subfield FORMAT and its refinements.

**Field descriptions for conditional datafill**

Field	Subfield	Entry	Explanation and action
	FORMAT	AUSTRIA, BASIC, CHINA, GERMAN, INTL, INTL2, or TURK	<p><i>CCITT format</i> This field specifies the CCITT7 point code refinements for the network.</p> <p>If the point code used is for Austria, enter AUSTRIA and datafill subfields ZONE, REGION, and SIGPOINT.</p> <p>If the point code used is based on one field, enter BASIC and datafill subfield PC.</p> <p>If the point code used is for China, enter CHINA and datafill subfields ZONE, EXCHANGE, and SIGPOINT.</p> <p>If the point code used is for Germany, enter GERMAN and datafill subfields NUMAREA, HVST, KVST, and SIGPOINT.</p> <p>If the point code used is international, enter INTL and datafill subfields ZONE, AREANETW, and SIGPOINT.</p> <p>If the point code used is international-2 with a 4-3-4-3 bit format, enter INTL2 and datafill refinements NETWORK, REGION, GROUP, and MEMBER.</p> <p>If the point code used is for Turkey, enter TURK and datafill subfields ZONE, REGION, and SIGPOINT.</p>
	ZONE	0 to 31	<p><i>Zone identifier</i> This field specifies the assigned zone identifier to the destination office and the specified network.</p> <p>If the entry subfield FORMAT is AUSTRIA, enter a number in the range 0 to 31.</p> <p>If the entry in subfield FORMAT is CHINA, enter a number in the range 0 to 15.</p> <p>If the entry in subfield FORMAT is INTL, enter a number in the range 0 to 7.</p>

## Field descriptions for conditional datafill

Field	Subfield	Entry	Explanation and action
			If the entry in subfield FORMAT is TURK, enter a value in the range 0 to 15.
	AREANETW	0 to 255	<i>Areanetwork identifier</i> If the entry in subfield FORMAT is INTL, enter the assigned number of the area/network identifier in the zone to the destination office for the specified network.
	REGION	0 to 15	<i>Region identifier</i> If the entry in subfield FORMAT is AUSTRIA, enter the number of the region identifier in the zone assigned to the destination office for the specified network.
			If the entry in subfield FORMAT is TURK, enter a value in the range 0 to 7.
	EXCHANGE	0 to 127	<i>Exchange</i> If the entry in subfield FORMAT is CHINA, enter the number of the exchange in the zone assigned to the destination office for the specified network.
	NUMAREA	0 to 15	<i>Numbering Area</i> If the entry in subfield FORMAT is GERMAN, enter the area number assigned to the office.
	HVST	0 to 7	<i>Hauptvermittlungsstelle (Tandem Level Switching Exchange)</i> If the entry in subfield FORMAT is GERMAN, enter the HVSt area assigned to the office.
	KVST	0 to 15	<i>Knotenvermittlungsstelle (Trunk Tandem Switching Exchange, regional exchange, 3rd level of transit/long distance network)</i> If the entry in subfield FORMAT is GERMAN, enter the KVSt area assigned to the office.

## Field descriptions for conditional datafill

Field	Subfield	Entry	Explanation and action
	SIGPOINT	0 to 127	<p><i>Signaling point identifier</i></p> <p>If the entry in subfield FORMAT is INTL, enter a numeric value between 0 and 7 for the signal point in the area/network assigned to the destination office for the specified network.</p> <p>If the entry in subfield FORMAT is AUSTRIA, enter a numeric value between 0 and 31 for the signal point in the region assigned to the destination office for the specified network.</p> <p>If the entry in subfield FORMAT is CHINA, enter a numeric value between 0 and 7 for the signal point in the exchange assigned to the destination office for the specified network.</p> <p>If the entry in subfield FORMAT is GERMAN, enter a numeric value between 0 and 7 specifying the signal point code of the exchange.</p> <p>If the entry in subfield FORMAT is TURK, enter a value in the range 0 to 127.</p>
	NETWORK	0 to 15	<p><i>Network</i></p> <p>If the entry in subfield FORMAT is INTL2, enter the network assigned to the office.</p>
	REGION	0 to 7	<p><i>Region</i></p> <p>If the entry in subfield FORMAT is INTL2, enter the region area assigned to the office.</p>
	GROUP	0 to 15	<p><i>Group</i></p> <p>If the entry in subfield FORMAT is INTL2, enter the group assigned to the office.</p>
	MEMBER	0 to 7	<p><i>Member</i></p> <p>If the entry in subfield FORMAT is INTL2, enter a numeric value between 0 and 7 for the member assigned to the destination office for the specified network.</p>

**NETTYPE = NTC7**

If the entry in subfield NETTYPE is NTC7, datafill refinements NMAINAREA, NSUBAREA, and NSIGPOINT.

**Field descriptions for conditional datafill**

Field	Subfield	Entry	Explanation and action
	NMAINAREA	0 to 255	<i>NTC7 main area</i> Enter the number of the main area assigned to the far-end switching unit for the specified network.
	NSUBAREA	0 to 255	<i>NTC7 subarea</i> Enter the number of the subarea of the main area assigned to the far-end switching unit for the specified network.
	NSIGPOINT	0 to 255	<i>NTC7 signaling point</i> Enter the number of the signaling point in the subarea assigned to the far-end switching unit for the specified network.

**NETTYPE = JPN7 or TTC7**

If the entry in subfield NETTYPE is has value JPN7 or TTC7, datafill refinements MAINAREA, SUBAREA, and AREAUNIT.

**Field descriptions for conditional datafill**

Field	Subfield	Entry	Explanation and action
	MAINAREA	0 to 31	<i>Main area</i> Enter the number of the main area assigned to the far-end switching unit for the specified network.
	SUBAREA	0 to 15	<i>Subarea</i> Enter a numeric value for the subarea in the main area assigned to this office for the specified network.
	AREAUNIT	0 to 127	<i>Area unit</i> Enter a numeric value for the area unit in the subarea assigned to this office for the specified network.



**For all NETTYPE values**

For all subfield NETTYPE entry values, datafill the following additional fields.

**Field descriptions for conditional datafill**

Field	Subfield	Entry	Explanation and action
NI		INTL, INTLSPARE, NATL, or NATLSPARE	<p><i>Network indicator</i></p> <p>Enter the type of network in this field. For an international network, enter INTL. For an international spare network, enter INTLSPARE. For a national network, enter NATL. For a national spare network, enter NATLSPARE.</p> <p>Both a network indicator (NI) and a network type (NETTYPE) are required to uniquely identify a network.</p> <p>Each NI can support up to 16 STP point codes.</p> <p><b>Note:</b> STP nodes sharing the same NI and network type must have unique point codes.</p> <p>STP point codes with the same NI can have different network types.</p>
SLSENH		Y or N	<p><i>SLS enhancement</i></p> <p>Enter N to use the original sls to link mapping algorithm.</p> <p>Enter Y to implement a new sls to link algorithm.</p> <p>The new SLS to link mapping is deterministic and provides correct balancing when vendors that use other methods send a non-full distribution of sls values.</p> <p>The default value for SLSENH is N. If patch SSG20/PFY20 is active before the ONP, it is recommended that this value be set to Y after the ONP has been completed. This field is only applicable to CCITT networks.</p>

## Field descriptions for conditional datafill

Field	Subfield	Entry	Explanation and action
SLSROT		Y or N	<p><i>SLS rotation</i></p> <p>This field determines if signaling link selection (SLS) rotation, for load sharing across links and combined linksets, is used as a part of the routing function. If the rotation of links in a linkset is required for loadsharing purposes, enter Y (yes). Otherwise, enter N (no).</p> <p><b>Note:</b> This field must be assigned Y in an ANSI network. If the field is assigned N in an ANSI network, the following error message displays:</p> <p>SLS ROTation has to be Y in ANSI network.</p> <p>Set this field to N for the following:</p> <ul style="list-style-type: none"> <li>• JPN7 networks</li> <li>• CCITT7 networks used in Australia</li> <li>• NTC7 networks</li> <li>• international networks</li> </ul>
TFR		Y or N	<p><i>Transfer restricted</i></p> <p>This field determines if transfer restricted is a part of the messaging protocol in the network. Enter Y if transfer restricted is a part of the messaging protocol in the network. Otherwise, enter N.</p> <p>Set this field to N for the following:</p> <ul style="list-style-type: none"> <li>• CCITT7 networks used in Australia</li> <li>• JPN7 networks</li> </ul>

## Field descriptions for conditional datafill

Field	Subfield	Entry	Explanation and action
MCS		1 or 3	<p><i>Multiple congestion</i></p> <p>This field determines the number of congestion levels used. Enter 1 if one level of congestion is required. Enter 3 if three levels of congestion are required.</p> <p>Set North American networks to 1 or 3.</p> <p>Set this field to 1 for the following:</p> <ul style="list-style-type: none"> <li>• CCITT7 networks used in Australia</li> <li>• NTC7 networks</li> <li>• international networks</li> </ul> <p>Set this field to 3 for JPN7 networks.</p>
CLUSTERS		Y or N	<p><i>Cluster messages</i></p> <p>This field determines if clustering is a part of the messaging protocol in the network. Enter Y if cluster messages (see note below) can be received. Otherwise, enter N.</p> <p>Set this field to Y for JPN7 networks.</p> <p>Set this field to N for the following:</p> <ul style="list-style-type: none"> <li>• CCITT7 networks used in Australia</li> <li>• NTC7 networks</li> </ul> <p><b>Note:</b> Cluster messages types include:  TCR - transfer cluster restricted  TCP - transfer cluster prohibited  TCA - transfer cluster allowed</p>
RCTEST		Y or N	<p><i>Routeset congestion test</i></p> <p>This field determines if the routeset congestion test is used to relieve remote route congestion. Enter Y if a routeset congestion test is used. Otherwise enter N.</p> <p>Set this field to N for the following:</p> <ul style="list-style-type: none"> <li>• CCITT7 networks used in Australia</li> <li>• JPN7 networks</li> </ul>

## Field descriptions for conditional datafill

Field	Subfield	Entry	Explanation and action
MTPRES		Y or N	<p><i>Message transfer part restart</i> Enter Y to enable the MTP restart procedure. Otherwise, enter N.</p> <p>The default value is Y.</p> <p>The MTP restart procedure can be enabled if the network type is ANSI7, CCITT7 or NTC7. The MTP restart procedure is disabled if the network type is TTC7 or JPN7.</p> <p><b>Note:</b> If an MTP restart procedure is in progress, the changed value for field MTPRES takes effect after the completion of the in-progress MTP restart procedure. The following message is issued.</p> <p>If an MTP Restart procedure is in progress, the modified control parameter shall be effective at the completion of that procedure.</p> <p><b>Note:</b> The value of field MTPRES is the same for all tuples of network types ANSI7, CCITT7 and NTC7. If an attempt is made to add a tuple with a different value of MTPRES to network types ANSI7, CCITT7 or NTC7 the following message appears:</p> <p>WARNING</p> <p>The MTPRES value must be the same for all networks that support MTP restart. The MTPRES has been updated same as other networks.</p>

## Field descriptions for conditional datafill

Field	Subfield	Entry	Explanation and action
			<p><b>Note:</b> The value of field MTPRES is the same for all tuples of network types ANSI7, CCITT7 and NTC7. If an attempt is made to change a tuple with a different value of MTPRES to network types ANSI7, CCITT7 or NTC7 the following message appears.</p> <pre>WARNING MTPRES has been changed for all network types that support MTP restart.</pre> <p><b>Note:</b> The value of field MTPRES must be set to N for network types JNP7 and TTC7. If an attempt is made to add a MTPRES field set to Y the following message will be issued.</p> <pre>WARNING MTP restart is not supported for this network type, MTPRES must be set to N.</pre>
PACERATE		0 to 10	<p>For ANSI STP networks, enter a value from 0 to 10. These values, expressed in tenths of a second, represent the pacing rate used when pacing transfer-allowed (TFA) / transfer-cluster-allowed (TCA) messages. The default value is 10. For non-ANSI and non-STP networks the default value is 0 and cannot be changed.</p>

## Datafill example

The following example shows sample datafill for table C7NETWRK.

## MAP display example for table C7NETWRK

NETNAME	NODETYPE			SLSROT	TFR	MCS	PTCODE CLUSTERS
	NI	MTPRES	PACERATE				
RCTEST							
NATL_NET	SSP_STP		ANSI7	171	1	0	
	NATL		Y	Y	3	Y	
Y	Y		10				
NATLSP_NET	SSP_STP		ANSI7	173	1	0	
	NATLSPARE		Y	Y	3	Y	
Y	Y		10				
INTL_NET	SSP_STP		ANSI7	172	1	0	
	INTL		Y	Y	3	Y	
Y	Y		10				
INTLSP_NET	ANSI7	2	2	2			
	SSP_STP		ANSI7	174	1	0	
	INTLSPARE		Y	Y	3	Y	
Y	Y		10				

## MAP display example for table C7NETWRK in a DMS-SSP or DMS-STP

NETNAME	NODETYPE			SLSROT	TFR	MCS	PTCODE CLUSTERS
	NI	MTPRES	PACERATE				
RCTEST							
STPNET	STP		ANSI7	240	248	16	
	NATL		Y	Y	3	Y	
Y	Y		10				
SSPNET	SSP		ANSI7	240	248	18	
	NATL		Y	Y	3	Y	
Y	Y		10				

**MAP display example for table C7NETWRK when USP\_ACTIVE\_IN\_NETWORK is set to Y**

NETNAME	NODETYPE				PTCODE
	NI	SLSROT	TFR	MCS	CLUSTERS
	RCTEST	MTPRES	PACERATE		
NEW_TESTNET	SSP	ANSI7	240	248	16
	NATL	Y	Y	3	Y
	N	N	N		

**Table history****CSP18/SN05**

Added field SLSSENH for SLS enhancements to non North American (CCITT) SSP markets using ITU signaling for feature 19013269.

**MMP15**

Added FORMAT TURK for feature 59022376.

**MSH14**

Information message added to direct the user to the USP GUI for access to table data when office parameter USP\_ACTIVE\_IN\_NETWORK is set to Y.

**STP05**

Modified table C7NETWRK as follows:

- Increased table size to 16 tuples.
- Allowed multiple STP nodes to be datafilled in the same NI.
- Allowed STP nodes with the same NI to have different network types.
- Added five messages to ensure the proper use of SEAS support for multiple point code (MPC) function.

**STP04.1**

The following changes were introduced:

- Added format INTL2 with the following refinements: NETWORK, REGION, GROUP, and MEMBER.
- Added field PACERATE.

**TL07**

Added note to SLSROT field for ANSI networks.

**TL06**

Added field NODE TYPE. Updated error messages to include restrictions for MNA7 capability.

**TL05**

Added field MTPRES.

**CSP02**

Explanatory text clarified for modifying tuples in the “Supplementary information” section.

**STP02**

Added NETTYPE NTC7 and its refinements.

## Supplementary information

This section provides additional information on datafilling table C7NETWRK.

If STP Signaling, Engineering, and Administration System (SEAS) software is present in the load, the following restrictions apply:

- The name selected to represent the network name (field NETNAME) must be exactly 11 characters. If an attempt is made to datafill a name that is not 11 characters, the tuple is rejected and the following error message is displayed:

*Example of a MAP display:*

```
SEAS IS PRESENT ON THE STP. NETNAME MUST BE 11 CHARACTERS.
```

- If the network being datafilled has a network indicator (field NI) of NATL and a network type (field NETTYPE) of ANSI7, the network name (field NETNAME) must consist of the last 11 characters of office parameter SEAS\_UAL\_STP\_NODE\_NAME in table OFCENG. If it does not, the tuple is rejected and the following error message is displayed:

*Example of a MAP display:*

```
SEAS IS PRESENT ON THE STP. NETNAME MUST BE <nnnnnnnnnnnn>.
```

In the actual error message displayed, the character string depicted as <nnnnnnnnnnnn> is replaced with the first 11 characters of office parameter SEAS\_UAL\_STP\_NODE\_NAME in table OFCENG.

**Note:** If MPC (TEL00012) is active, this restriction applies only to the first ANSI7 NATL tuple.



If MNA7 capability is present in the load, the following restrictions apply:

- When a tuple is added to table C7NETWRK, its type is verified against “C7\_current\_node\_type”. The node type supports SSP, STP, SCP or any combination. The following is an example of the node type that is displayed when an incorrect node type is added or modified:

*Example of a MAP display:*

The network node type must be a subset of the office node type. The office node type is an SSP.

- If the node type within a tuple is being changed, a check is performed against the link types datafilled in table C7LKSET. Only the transition from SSP to/from SSP/STP is allowed. The following error message is displayed if the transition is not allowed:

*Example of a MAP display:*

The node type change is not a valid transition.

- Tuples with the same NI must be the same network type. The following error message is displayed:

*Example of a MAP display:*

Tuples with the same network indicator must contain the same network type.

- Depending on the previously datafilled tuple of the same NI, one of the following messages is displayed:

*Examples of a MAP display:*

Expecting CCITT Standard network type.  
Expecting ANSI Standard network type.  
Expecting NTC Standard network type.  
Expecting Japan TTC Standard network type.  
Expecting Japan Public Standard network type.

- The OPC for each tuple with the same NI cannot be the same. Other tuples with a different NI within table C7NETWRK can have the same OPC data filled. If the OPC for a tuple is identical to the NI, the following error message is displayed:

*Example of a MAP display:*

The point code is already in use for the given network indicator.

- When you first datafill multiple network addresses, software optionality control (SOC) must be enabled. If SOC is not enabled, you can only activate links within one node of the two nodes with the same NI. If you have not enabled SOC, the following warning message is displayed:

*Example of a MAP display:*

WARNING: Datafill for multiple network addresses will be created.

Only one network can contain active links if MNA7 SOC is not enabled.

- MNA7 tuples cannot be datafilled in a network if those tuples are datafilled in GATEPC tables. MNA7 tuples exist if two or more C7NETWRK tuples contain the same NI.
- The last tuple with a specific NI cannot be deleted if the NI contains a tuple in table GATEPC.
- Only one node of the same type can be datafilled for a network. You cannot have two STP nodes in the same network. If you attempt to datafill two nodes in the same network, the following error message is displayed:

*Example of a MAP display:*

The node type is already in use for the given network indicator.

**Note:** The above restriction does not apply when MPC (TEL00012) is active.

- When MPC (TEL00012) is active, the maximum number of nodes for each network is 16. If this limit is exceeded, the following error message is displayed:

*Example of a MAP display:*

The maximum number of STP nodes already exists for the given NI.

- The maximum number of SSP nodes in a network is one. An SSP and an INode cannot exist under the same NI as they are considered to be alike. The following error message is displayed:

*Example of a MAP display:*

Only one node with SSP capability is supported for a given network indicator.

**Note:** The above restriction does not apply when MPC (TEL00012) is active.

- A network must contain only an SSP, STP or SSP/STP node type. An SSP/STP is considered to be an SSP node. Therefore, an SSP/STP and STP combination is a valid set, but an SSP/STP and SSP is not.

- The only transitions allowed when changing node types are changing an SSP to an SSP/STP, and changing an SSP/STP to an SSP.
- STP nodes must only contain A, B, C, D, or E links.
- SSP/SCP nodes must only contain A, E, or F links.
- An SSP or a service control point (SCP) do not support all linksets supported by an STP. The node type cannot be modified if the new node type does not support the links datafilled in table C7LKSET. The following error message is displayed:

*Example of a MAP display:*

```
An SSP or SCP cannot support the B, C, or D link type defined
in table C7LKSET.
```

- An STP does not support all linksets supported by other node types. The node type cannot be modified if the new node type does not support the links datafilled in table C7LKSET. The following error message is displayed:

*Example of a MAP display:*

```
An STP cannot support the F link type defined in table
C7LKSET.
```

- An SSP and STP does not support all linksets supported by other node types. The node type cannot be modified if the new node type does not support the links datafilled in table C7LKSET. The following error message is displayed:

*Example of a MAP display:*

```
An INode cannot support the F link type defined in table
C7LKSET.
```

- Tuples in table C7NETWRK with the same NI will be verified to have the same point code format. A warning message indicates if there is an incorrect point code format.
- If you attempt to add a multiple STP entry to an NI with an unsupported network type, the following error message is displayed:

*Example of a MAP display:*

```
The following network types are only supported for multiple
STP nodes per NI: ANSI, ITU and NTC7.
```

- When the multiple point code (MPC) SOC (TEL00012) is on, you can add national ANSI networks to table C7NETWRK. However, if the name of the network you add does not match the office parameter SEAS\_UAL\_STP\_NODE\_NAME, SEAS displays a warning message to indicate that SEAS cannot interact with the added network.

*Example of a MAP display:*

Warning: Network name does not match the office parameter SEAS\_UAL\_STP\_NODE\_NAME. SEAS cannot interact with this network.

- When you perform a one-night process (ONP), SEAS displays a warning message when there is no national ANSI network name in table C7NETWRK that matches the office parameter SEAS\_UAL\_STP\_NODE\_NAME.

*Example of a MAP display:*

Warning: Office parameter does not match a NATL, ANSI network name in table C7NETWRK. SEAS will not function with any network.

- If you attempt to use the C7RENAME command to rename a network in table C7NETWRK that is not a national ANSI network to the same network name in office parameter SEAS\_UAL\_STP\_NODE\_NAME, the system displays the following error message:

*Example of a MAP display:*

Error: Non-ANSI, non-NATL networks cannot have network names that match the office parameter SEAS\_UAL\_STP\_NODE\_NAME.

- If the network you attempt to add to table C7NETWRK from the MAP terminal is not a national ANSI network, and has the same network name as office parameter SEAS\_UAL\_STP\_NODE\_NAME, the system displays the following error message:

*Example of a MAP display:*

Error: Non-ANSI, non-NATL networks cannot have network names that match the office parameter SEAS\_UAL\_STP\_NODE\_NAME.

- If the network name you attempt to change in office parameter SEAS\_UAL\_STP\_NODE\_NAME matches a network name in table C7NETWRK that is not a national ANSI network, the system displays the following error message:

*Example of a MAP display:*

Error: Office parameter must belong to an ANSI, NATL network.

- If office parameter USP\_ACTIVE\_IN\_NETWORK is set to Y, the system displays the following message when you try to add, delete, or change a tuple:

*Example of a MAP display:*

```
*****
*                                     WRITE ACCESS DENIED                               **
*****
****
** The USP is now used to administer the SS7 data.
**
** Network information can only be displayed for this table.
**
**                                     **
** Go to the GUI on the USP to modify this data.
**
*****
****
```

**Adding a network to table C7NETWRK**

To add a network to table C7NETWRK, the following information must be specified:

- the name of the network
- the type of network
- the office's OPC
- a unique network indicator that is unique to the network
- whether SLS rotation is used
- the number of congestion levels used
- if clustering is a part of the network messaging protocol
- if MTP is enabled or disabled for the network

**Modifying a network in table C7NETWRK**

Only fields SLSROTAT, TFR, CLUSTERS, RCTEST, MTPRES, and PACERATE can be modified in table C7NETWRK. All other fields require that the network be deleted and re-added with the new data. Many tables in CCS7 are dependent on the data in table C7NETWRK, so that the rules for modifying any fields other than those listed are the same as for deleting a network.

**Deleting a network from table C7NETWRK**

A network cannot be deleted until all linksets and routesets have been deleted from that network. Use table control to delete linksets and routesets from tables C7LKSET and C7RTESET.

Additional dependencies apply when deleting linksets and routesets. Refer to the table descriptions for tables C7LKSET and C7RTESET.

## C7OPCTAB

---

### Table name

The CCS7 Origination Point Code Table

### Functional description

Table C7OPCTAB is an information base that identifies the origination points of CCS7 message signaling units (MSU) to a DMS-300 Gateway switching office.

The table lists the available origination point codes (OPC) for the DMS-300 office. This list allows you to record the volume of MSUs against specified origination nodes. The operating company uses the node volume for network traffic planning.

This table does not allow tuple changes. You must delete a tuple from table C7OPCTAB and add the tuple again.

### Datafill sequence and meaning

You must enter data in table C7NETWRK before you enter data in table C7OPCTAB.

### Table size

0 to 128 tuples

The system automatically allocates memory for 128 tuples.

### Datafill

The datafill for table C7OPCTAB appears in the following table.

#### Field descriptions (Sheet 1 of 2)

Field	Subfield or refinement	Entry	Explanation and action
INDEX		1 to 128	<i>Internal CCITT origination point code representation.</i> Enter the index for the OPC to add to the table. This field identifies the CCITT 14-bit point codes in compressed format.
NETNAME		alphanumeric (1 to 16 characters)	<i>Network name.</i> Enter the specified network to which the OPCs correspond.

**C7OPCTAB** (continued)**Field descriptions (Sheet 2 of 2)**

Field	Subfield or refinement	Entry	Explanation and action
NETTYPE		CCITT7	<i>Network type.</i> Enter CCITT7 to select the nature of the prompted OPC.
FORMAT		INTL	<i>Point code format.</i> Enter INTL for DMS-300 international point code format.
OPC		see subfields	<i>Origination point code.</i> This field contains subfields ZONE, AREANETW, and SIGPOINT. Each field represents part of a different addressing design used for each signaling origination network. The international FEPC (far end point code) network identification design contains these three parts.
	ZONE	0 to 7	<i>Zone identifier.</i> Enter the zone identifier for the international network.
	AREANETW	0 to 255	<i>Area network identifier.</i> Enter the area network identifier for the international network origination office.
	SIGPOINT	0 to 7	<i>Signal point identifier.</i> Enter the signal point identifier for the international network destination office.

**Datafill example**

Sample datafill for table C7OPCTAB appears in the following example.

**MAP example for table C7OPCTAB**

INDEX	NETNAME	NETTYPE	FORMAT	OPC
105	C7NETWRK2	CCITT7	INTL	6 241 3

**Additional information**

This section provides information on possible error messages when you enter data in table C7OPCTAB.



## **C7OPCTAB** (end)

---

### **Datafill error messages**

\$1>This table does not allow tuple changes. You must delete a tuple from table C7OPCTAB and add the tuple again. If you attempt to change a tuple in the table, the following error message appears:

```
'CHANGES NOT ALLOWED, USE DELETE THEN ADD'
```

\$1>If you attempt to add a tuple with the same index as a tuple you delete, a message appears. If you delete a tuple with the same index in the current 24 h period, the following error message appears:

```
'CANNOT ADD TUPLE, MANUAL DIRP ROTATE REQUIRED'
```

To prevent the Device Independent Recording Package (DIRP) message, manually rotate the DIRP after the next polled load from the LIUs. If you manually rotate the DIRP, you can make the preceding data changes and the DIRP error message does not appear.

---

**C7PECRCD**

---

**Table name**

Pan-European Cellular Radio Called Party Address Table

**Functional description**

Table C7PECRCD provides pan-European cellular radio (PECR) called party addresses. The DMS-300 uses this table to measure and record the volume of signaling connection control part (SCCP) messages that pass through the DMS-300. This table records messages sent from the link interface unit (LIU) for Common Channel Signaling 7 (LIU7) peripheral modules (PM).

The calling and called party addresses take the form of a string of digits. This string of digits conforms to E.164 or E.214. The E.164 or E.214 are identical for the purpose of message recording.

**Datafill sequence and meaning**

You must enter data in table C7NETWRK before you enter data in table C7PECRCD.

**Table size**

1 to 64 tuples

**C7PECRCD** (end)**Datafill**

Datafill for table C7PECRCD appears in the following table.

**Field descriptions**

Field	Subfield or refinement	Entry	Explanation and action
TUPLE		1 to 64	<i>Pan-European cellular radio address.</i> Enter the PECCR calling party address.  The default value is 0 (zero).
PECRCDDPA		0 to 99 999	<i>Pan-European called party address.</i> Enter the called party address. To specify a range of addresses, enter a maximum of five digits.  If you specify a range of addresses, the table does not allow entries that cause an overlap of ranges. For example, if the current value is 123, you cannot enter 12345 or 1239. You cannot enter 12345 or 1239 because 12345 and 1239 are in the range of the entered value. If the current value is 12345, you cannot enter 123 or 1239. You cannot enter 123 or 1239 because the ranges of 123 and 1239 overlap with the entered value.  The default value is 0 (zero).

**Datafill example**

Sample datafill for table C7PECRCD appears in the following example.

**MAP example for table C7PECRCD**

TUPLE	PECRCDDPA
1	34521

**Table history****BCS34**

Table C7PECRCD was introduced in BCS34.

---

**C7PECRCG**

---

**Table name**

Pan-European Cellular Radio Calling Party Address Table

**Functional description**

Table C7PECRCG provides pan-European cellular radio (PECR) gateway switch calling party addresses. The DMS-300 uses the table to measure and record the volume of the signaling control connection part (SCCP) messages that pass through DMS-300. The table records messages sent from the link interface unit (LIU) for Common Channel Signaling 7 (LIU7) peripheral modules (PM). The table also collects the counts of failure messages and messages that the system cannot route.

The calling and called party addresses take the form of a string of digits. The string of digits conforms to E.164 or E.214. The E.164 and E.214 are identical for the purpose of message recording.

**Datafill sequence and meaning**

You must enter data in table C7NETWRK before you enter data in table C7PECRCG.

**Table size**

1 to 64 tuples

## C7PECRCG (end)

### Datafill

Datafill for table C7PECRCG appears in the following table.

#### Field descriptions

Field	Subfield or refinement	Entry	Explanation and action
TUPLE		1 to 64	<i>Pan-European cellular radio address.</i> Enter the PECR calling party address.  The default value is 0 (zero).
PECRCGPA		0 to 99 999	<i>Calling party address.</i> Enter the calling party address. To specify a range of addresses, enter a maximum of five digits.  If you specify a range of addresses, this table does not allow entries that cause an overlap of ranges. For example, if the current value is 123, you cannot enter 12345 or 1239. You cannot enter 12345 or 1239 because 12345 and 1239 are in the range of the entered value. If the current value is 12345, you cannot enter 123 and 1239. You cannot enter 123 and 1239 because the ranges of 123 and 1239 overlap with the entered value.  The default value is 0 (zero).

### Datafill example

Sample datafill for table C7PECRCG appears in the following table.

#### MAP example for table C7PECRCG

TUPLE	PECRCGPA
1	34521

### Table history

#### BCS34

Table C7PECRCG was introduced in BCS34.

---

**C7ROUTER**

---

**Table name**

Common Channel Signaling System 7 Routers Table

**Functional description**

Table C7ROUTER serves as a look-up table for CCS7 link interface unit (LIU7) peripheral modules (PM) used by CCS7 digital trunk controllers (DTC7) to route ISDN user part (ISUP) messages to the appropriate links.

**Restrictions**

The following restrictions and error messages apply to table C7ROUTER:

- The LIU7 associated with a router must be an 8-Mbyte or 32-Mbyte LIU7.
- To support tuples beyond 100000 in table C7TRKMEM, the LIU7s associated with a router must all be 32 Mbyte. The system displays the following error message if the condition is not met:

```
The current number of ISUP Circuit is <number>. This Router
will not be able to support this. Please remove tuples from
table C7TRKMEM before making this change to this table.
```

- The associated LIU7 must be datafilled in table LIUINV.
- An LIU7 cannot be used simultaneously as a router and a link, that is, it cannot be datafilled in both table C7ROUTER and table C7LINK.
- To support external routing, routing information must be removed from the DTC7.
- Signaling transfer point (STP) links on an multiple network address (MNA7) integrated DMS-SSP/STP node (INode) do not have to reside in the LIM containing all the routers.
- Table C7ROUTER must be datafilled before enabling external routing.
- You can use LIU7 external routers on any of the following platforms:
  - link peripheral processor (LPP), enhanced LPP (ELPP), or fiberized LPP (FLPP)
  - DMS SuperNode SE link interface shelf (SNSE LIS)
  - fiber link interface shelf (FLIS)
- F-bus half-shelves used for LIU7 datafill must contain similar numbers of LIU7 routers. If a router is placed on a shelf that has significantly more

**C7ROUTER** (continued)

routers than any other shelf, the tuple is accepted, but the following warning message is displayed:

WARNING: LIU7 routers are not balanced on LPP/SNSE-LIS/FLIS half shelves.

**Note:** SNSE platforms support only one router for each ENET half-shelf.

**Datafill sequence and implications**

Table LIUINV must be datafilled before table C7ROUTER.

**Table size**

0 to 7 tuples

**Datafill**

The following table lists datafill for table C7ROUTER.

**Field descriptions**

Field	Subfield or refinement	Entry	Explanation and action
RTRNUM		1 to 32	<i>Router number</i> Enter a unique router number. This is the key field to table C7ROUTER.
RESOURCE		see subfields	<i>Resource description</i> This field consists of subfields PMTYPE and LIU7INDEX.
	PMTYPE	LIU7	<i>Peripheral module type</i> Enter LIU7 for a CCS7 link interface unit.
	LIU7INDEX	0 to 511	<i>LIU7 index</i> Enter the index number from field LIUNO in table LIUINV for the LIU7 designated as the router.  <b>Note:</b> The same LIU7 cannot be designated as the router for more than one router number. Datafilling the same LIU7 index a second time results in an error message.

**C7ROUTER** (continued)**Datafill example**

The following example shows sample datafill for table C7ROUTER.

**MAP display example for table C7ROUTER**

RTRNUM	RESOURCE
1	LIU7 101
2	LIU7 102
5	LIU7 103
24	LIU7 105
31	LIU7 107
32	LIU7 202

**Table history****NA013**

Added new restriction and error message to support tuples beyond 100000 in table C7TRKMEM for Succession Network VToA (Voice Trunking over ATM) application release 01.

**TL12**

Removed the restriction regarding the placement of LIU7 external routers on a single LPP or an LPP-LIS/LPP-FLIS combination.

**TL11**

Removed from section "Limits" restriction regarding the placement of SSP links and routers on the same LPP.

**TL09**

New error messages and restrictions were added to allow LIU7 router datafill on SNSE LIS or FLIS F-bus platforms.

**TL08**

New restrictions and error messages for allowable tuples in table C7ROUTER were introduced to allow SNSE LIS-based LIU7s to be datafilled as external routers.

**TL07**

Changes introduced in the CSP08 software release were patched back to CSP07.



## **C7ROUTER** (end)

---

### **TL06**

Table C7ROUTER updated to allow datafill on both an INode switch and an SSP switch.

### **TL04**

Table C7ROUTER sizing changed to reflect minimum and maximum number of entries to activate external routing.

### **BCS36**

Table C7ROUTER was introduced.

---

**C7RPLSSN**

---

**Table name**

CCS7 Replicate Subsystem Table

**Functional description**

Table C7RPLSSN provides the set of remote subsystem replicate pairs or replicate groups. It has a one-part key, the subsystem name. For each subsystem a list of point codes (PC) at which the replicated subsystems reside must be given.

If loadsharing is required between a replicated pair datafilled in table C7RPLSSN, both members of the pair also must be datafilled in table C7GTT as results with equal cost. If both results are datafilled in C7GTT with different costs, then the one with the lower cost will carry all traffic and the other will serve as a backup only.

For related information, refer to table C7NETSSN.

**Adding a subsystem to table C7RPLSSN**

To add a subsystem replicate pair to table C7RPLSSN, the following information is required:

- the subsystem name. The values of the UNKNOWN subsystem and SCMG are invalid.
- the list of PCs at which the replicate subsystems reside
- the corresponding subsystem at the given PCs, which must be datafilled in table C7NETSSN. The traffic mix information must be specified for each replicate pair.

**Modifying a subsystem in table C7RPLSSN**

The list of replicated subsystem pairs, as defined by a pair of PC names where the subsystem resides, can be modified. A new list of replicate pairs is entered, repeating those that have not changed and adding any new pairs. The subsystems in these pairs must be datafilled at the PC given in table C7NETSSN.

## **C7RPLSSN** (continued)

---

The following fields can be modified:

- **REPL\_NODE1** The first PC name of the replicate can be deleted or modified only if there are no GTTs in the CCS7 translation tables that result in the replicate pair.
- **REPL\_NODE2** The second PC name of the replicate can be deleted or modified only if there are no GTTs in the CCS7 translation tables that result in the replicate pair.
- **TFMI\_USERS** The flag, indicating whether signaling connection control part (SCCP) management generates subsystem backup routing (SBR) and subsystem normal routing (SNR) messages used for traffic mix information for this replicate, can be changed.

### **Deleting a subsystem from table C7RPLSSN**

The set of replicate pairs in field REPLIST for a given subsystem, can be deleted only if there are no GTTs in the CCS7 translation tables that result in any of the replicate pairs for this subsystem.

The set of replicate pairs for a given subsystem can be deleted without requiring that the affected subsystems be offline.

### **Datafill sequence and implications**

The following tables must be datafilled before table C7RPLSSN

- **C7NETSSN** Each network subsystem defined as a member of a replicate pair DRU="STP"> or replicate group must be defined in table C7NETSSN before it is datafilled in table C7RPLSSN.
- **C7LOCSSN**

Table C7GTT is datafilled after table C7RPLSSN if more than one result is used for a single GT range. DRU="STP"> Table C7GTRSLT is datafilled after table C7RPLSSN if any PCSSN result types, including NEWGT, are datafilled.

### **Table size**

0 to 256 tuples

The maximum number of tuples allowed in this table is fixed to the maximum number of subsystems defined.

**C7RPLSSN** (continued)**Datafill**

The following table lists datafill for table C7RPLSSN

**Field descriptions (Sheet 1 of 4)**

Field	Subfield or refinement	Entry	Explanation and action
SSNAME		see below	<i>Subsystem name</i> The subsystem names can be from one to eight characters in length. A predefined subsystem name entry is taken from table C7NETSSN, field PCSSN. A signaling connection control part (SCCP) user is known as a subsystem. The meanings of the predefined subsystem names are as follows:
		800P	800P (Canadian version of CCS7 800 Service [800 Plus] 800P is provided if feature package NTX555AB [800 Plus] is in the switching unit. Otherwise, E800 is provided.)
		ACCS	Enter ACCS to specify the automatic calling card service subsystem.
		ACCTSS	Enter ACCTSS to specify the account code validation subsystem.
		AUTHSS	Enter AUTHSS to specify the authcode verification subsystem.
		BNS	Enter BNS to specify the billing number screening subsystem.
		CMS	Enter CMS to specify the call management service subsystem.  <b>Note:</b> Entry CMS is Canada only.
		CNAMD	Enter CNAMD to specify the Custom Local Area Signaling Service (CLASS) Calling Name Delivery (CNAMD) subsystem.
		CS1R	Enter CS1R to specify the Capability Set 1 (CS1) subsystem.
		E800	Enter E800 to specify the Enhanced 800 service subsystem.

**C7RPLSSN** (continued)

## Field descriptions (Sheet 2 of 4)

Field	Subfield or refinement	Entry	Explanation and action
		INTERWRK	Enter INTERWRK to specify the subsystem used for features that are interworked between primary rate access (PRA) and SS7.
		ISDNUP	Enter ISDNUP to specify the ISDN user part subsystem.
		N00	Enter N00 to specify the N00 calling service subsystem.
		NMS	Enter NMS to specify the network message service subsystem.
		NSSTCN	Enter NSSTCN to specify the network services software (NSS) travel card number.
		OAM	Enter OAM to specify the operations, administration, and maintenance subsystem.
		OLNS	Enter OLNS to specify originating line number screening.
		PVN	Enter PVN to specify the private virtual network subsystem.
		REPLDIGS	Enter REPLDIGS to specify the NSS database control point DBCP replace dialed digits application.
		RTRS	Enter RTRS to specify the TOPS real-time rating system.
		SCPACCS	Enter SCPACCS to specify the ACCS database (SCP) subsystem.
		SCPBNS	Enter SCPBNS to specify the BNS database (SCP) subsystem.
		SCPE800	Enter SCPE800 to specify the E800 database (SCP) subsystem.
		TCN	Enter TCN to specify the travel card service subsystem.
		TOPSLNP	Enter TOPSLNP to specify the TOPS local number portability

**C7RPLSSN** (continued)

## Field descriptions (Sheet 3 of 4)

Field	Subfield or refinement	Entry	Explanation and action
REPLIST		TUP  see subfields	<p>Enter TUP to specify the telephone user part subsystem.</p> <p><i>Replicate list</i> This field is a vector of up to 12 replicated pairs. If fewer than 12 pairs are required, end the list with a \$ (dollar sign). Each member of the list represents a pair of point code (PC) names, the PCs where each member of the replicated pair resides, and a flag indicating whether signaling connection control part (SCCP) management generates subsystem backup routing (SBR) and subsystem normal routing (SNR) messages used for traffic mix information for this replicated pair.</p> <p>Datafill the first part of the pair in subfield REPL_NODE1, the second part of the pair in subfield REPL_NODE2, and the traffic mix information in subfield TFMI_USERS.</p> <p><b>Note:</b> REPL_NODE1 and REPL_NODE2 entries must be the same network type. For example, if REPL_NODE1 is an ANSI routeset and REPL_NODE2 is a CCITT routeset, the tuple is incorrect and results in an error message.</p> <p><b>Note 1:</b> REPL_NODE1 and REPL_NODE2 entries must be the same node type. For example, if REPL_NODE1 is an SSP routeset and REPL_NODE2 is an SSP/STP routeset, the tuple is incorrect and results in an error message.</p> <p><b>Note 2:</b> Routing information for the subsystem at the given PC must first be datafilled in table C7NETSSN.</p>

## C7RPLSSN (continued)

### Field descriptions (Sheet 4 of 4)

Field	Subfield or refinement	Entry	Explanation and action
	REPL_NODE1	alphanumeric (1 to 16 characters)	<p><i>Replicate node one</i> Enter the first PC name of the replicate at which the replicate subsystem resides.</p> <p><b>Note:</b> The PC must be datafilled in table C7NETSSN with the subsystem given in field PCNAME.</p>
	REPL_NODE2	alphanumeric (1 to 16 characters)	<p><i>Replicate node two</i> Enter the second PC name of the replicate at which the replicate subsystem resides.</p> <p><b>Note:</b> The PC must be datafilled in table C7NETSSN with the subsystem entered in field PCNAME.</p>
	TFMI_USERS	Y or N	<p><i>Traffic mix information users</i> Enter Y (yes) if SCCP management generates SBR and SNR messages used for traffic mix information for this replicate pair. Otherwise, enter N (no).</p>

### Datafill example

The following example shows sample datafill for table C7RPLSSN.

#### MAP display example for table C7RPLSSN

SSNAME	REPLIST	GRPLIST
ACCS	( SCP3 SCP4 N)\$	( (SCP5) (SCP6) (SCP7) \$) \$

For further information and datafill examples, see table C7NETSSN.

### Table history

#### GL03

Value CS1R added to field SSNAME.

---

**C7RPLSSN** (end)

---

**CSP06**

Value OLNS added to field SSNAME by feature AN1564 in functionality TOPS OLNS Interface, ABS00012.

**CSP04**

Added value RTRS to field SSNAME per feature AN1504 in functionality External RTRS Interface, ENSV0009

**BCS36**

Reference in subfield SSNAME to BCS30 was removed. Subsystem CNAMD was added to field SSNAME.



## **C7RSSCRN**

---

### **Table name**

Common Channel Signaling 7 Remote Subsystem Concerned Node Table

### **Functional description**

Table C7RSSCRN provides a list of concerned nodes for a remote subsystem point code combination. The table has a two part key. The first part is the point code (PC) and the second part is the subsystem name. The PC and subsystem combination must be datafilled in table C7NETSSN.

The concerned node list is a list of PC names that must each be datafilled in table C7NETSSN.

For related information, refer to table C7NETSSN.

### **Adding a tuple to table C7RSSCRN**

To add a tuple to table C7RSSCRN the following information is required:

- a remote PC and subsystem combination
- a list of PC names (concerned nodes) that need to know when the PC and subsystem changes state

### **Modifying a tuple in table C7RSSCRN**

The list of concerned nodes in field PCNAMES can be modified. To modify the list of concerned nodes, repeat those that have not changed and add any new nodes.

### **Datafill sequence and implications**

Table C7NETSSN must be datafilled before table C7RSSCRN.

Table C7RSSCRN depends on table C7NETSSN. Each PC and subsystem key must be datafilled in table C7NETSSN and each entry in field PCNAMES (the concerned node list) must also be datafilled in table C7NETSSN.

### **Table size**

0 to 256 tuples

Table size is limited by the number of PC and subsystem combinations datafilled in table C7NETSSN.

**C7RSSCRN** (continued)**Datafill**

The following table lists datafill for table C7RSSCRN.

**Field descriptions (Sheet 1 of 2)**

Field	Subfield or refinement	Entry	Explanation and action
PCSSN		see subfields	<i>Point code subsystem combination</i> This field consists of subfields PCNAME and SSNAME.
	PCNAME	alphanumeric (1 to 16 characters)	<i>Point code name</i> Enter the common language location identifier (CLLI) of the remote point code (PC) for which the concerned node list applies.
	SSNAME	800P, ACCS, ACCTSS, AIN01, AIN02, AUTHSS, BNS, CMS (see note), E800, INTERWRK, ISDNUP, N00, NMS, NSSTCN, OAM, PVN, REPLDIGS, SCPACCS, SCPBNS, SCPE800, TCN, or TUP	<p><i>Subsystem name</i>The subsystem names can be from one to eight characters in length. A pre-defined subsystem name entry is taken from table C7NETSSN, field PCSSN. The meanings of the predefined subsystem names are as follows:</p> <p>800P (Canadian version of CCS7 800 Service (800 +) 800P is provided if feature package NTX555AB (800 Plus) is in the switching unit. Otherwise, E800 is provided)</p> <p>ACCS (Automatic Calling Card Service)</p> <p>ACCTSS (account code validation)</p> <p>AIN01 (AIN essentials)</p> <p>AIN02 (AIN service enablers)</p> <p>AUTHSS (authcode verification)</p> <p>BNS (billed number screening)</p> <p>CMS (Call Management Service)</p> <p><b>Note:</b> Canada only</p> <p>E800 (Enhanced 800 Service)</p> <p>INTERWRK (used for features interworked between primary rate interface [PRA] and Signaling System 7 [SS7])</p>

**C7RSSCRN** (continued)

## Field descriptions (Sheet 2 of 2)

Field	Subfield or refinement	Entry	Explanation and action
	SSNAME (continued)		ISDNUP (ISDN user part) N00 (N00 calling service) NMS (network message service) NSSTCN (network services software [NSS] travel card number) OAM (operations, administration, and maintenance) PVN (private virtual network) REPLDIGS (NSS database control point [DBCP] replace dialed digits application) SCPACCS (ACCS database switching control point [SCP]) SCPBNS (BNS database [SCP]) SCPE800 (E800 database [SCP]) TCN (travel card service) TUP (telephone user part)
PCNAMES		vector of up to 8 PCs	<i>Remote concerned node list</i> This field is a vector of up to eight PC names. This field contains a list of nodes that are kept informed of status changes at the remote subsystem. The PCs must be datafilled in table C7NETSSN. If less than eight names are required, end the list with a \$ (dollar sign).

**Datafill example**

The following example shows sample datafill for table C7RSSCRN.

---

**C7RSSCRN** (end)

---

**MAP display example for table C7RSSCRN**

PCSSN	PCNAMES
ANSIRTSABC ACCS	(ANSIRTSCBA) \$

**Table history****NA007**

Value AIN02 added to field SSNAME by feature AJ4099.

Value TOPSLNP added to field SSNAME by feature AF6549.

**BCS36**

Reference in subfield SSNAME to BCS30 was removed.

## C7RTESET

---

### Table name

CCS7 Routeset Table

### Functional description

Table C7RTESET supports a logical association between linksets that are used as possible routes for each signaling point in the network. An office point code uniquely identifies a signaling point within any network. Each office point code must have a routeset.

The information in this table records which routesets and linksets can carry the signaling information to the destination signaling point. This table is also used for alternative routing decisions.

*Note:* When office parameter USP\_ACTIVE\_IN\_NETWORK is set to Y, you can display tuple information. Attempts to add, delete, or change a tuple in this table using the DMS table editor generate a message referring you to the Graphical User Interface (GUI) on the Universal Signaling Point (USP) for proper access to data for this table.

Signaling transfer points (STP) must have a routeset datafilled, regardless of whether any user parts terminate messages at the STP. This enables each linkset to identify the routeset that delivers messages to its far end.

*Note:* All references to signaling transfer point (STP) are applicable to the DMS integrated nodes (INode), unless otherwise specified.

Table C7RTESET is keyed on the name of the routeset. Because a routeset name is unique only within the network in which it is defined, the network name must be specified. Textual names provide a convenient way of representing the routeset name. The actual destination must also be specified. The destination point code (DPC) depends upon the network type that is chosen.

If it is possible to receive transfer messages for certain clusters, datafill those clusters with their own unique routeset. This datafill improves the handling of status messages for those clusters, allowing the LOG and OM systems to identify affected clusters. If a cluster does not have its own routeset, the remote service module (RSM) treats a cluster message as a group of destination-oriented messages.

A list of up to six linksets, in priority order, one at a time, can be specified to define a particular routeset. The order defines the sequence in which a signaling linkset is chosen for signaling to the DPC.

---

**C7RTESET** (continued)

---

A route is described by the linkset name and by a cost that is relative to this routeset. The cost is a value between 0 and 99. To specify a combined linkset, define two routes with the same cost.

It is the relative value of the cost that is important, rather than the value itself. When defining routes with respect to the cost, each route must have a cost equal to or greater than the cost of the route that was defined before it.

Routeset expansion is available for the SSP, STP, and DMS-INodes. The routeset limit for each of these nodes is 2K. Routeset expansion is SOC controlled and can be set to 255, 511, 767, 1023, 1279, 1535, 1791, or 2047.

External routing must be enabled on the SSP and DMS-INodes when the routeset tuples exceed 255.

**Interaction of table C7RTESET and table C7LKSET**

The default route mode of an added routeset tuple is QUASI. If the far-end point code (FEPC) of a linkset in table C7LKSET has the same point code as the added routeset, the linkset appears as a route in the routeset, and if the route has a unique cost so that it is not part of a combined linkset, the added routeset assumes the mode ASSOC and functions in the same manner as routes that are explicitly datafilled as ASSOC.

If a tuple in table C7LKSET is changed and the FEPC is also changed, all routesets defined in C7RTESET are checked. If an ASSOC route has been formed with the linkset and if the corresponding routeset is offline, the route becomes a QUASI route. A search is initiated for the routeset whose DPC matches the changed FEPC of the linkset. The route becomes the ASSOC route in the routeset.

*Note:* A linkset in a combined linkset cannot be implicitly made into the ASSOC route.

Route changes in a routeset tuple can cause the mode of a route (linkset) to change. Linksets that can change from ASSOC to QUASI or QUASI to ASSOC must be offline or the change is disallowed.

**Adding a routeset to table C7RTESET**

In order to add a routeset, the following information is required:

- a 1-to-16-character name that identifies the routeset. This name is defined in table C7RTESET.
- the name of the network to which the routeset is added. The network name must be defined in table C7NETWRK before adding a routeset.

## **C7RTESET** (continued)

---

- the network type, as defined in table C7NETWRK
- whether a transfer prohibited (TFP) or a transfer cluster prohibited (TCP) message is broadcast to all adjacent signaling points (if the switching unit is an STP)
- the point code of the destination office to which the routeset establishes signaling paths. The point codes must be unique within the network.
- the name of the linksets added to the routeset, listed in order of priority. These linksets are first defined in table C7LKSET.

The following restrictions apply when adding a routeset:

- When datafilling a routeset, at least one route (LINKSET) must be datafilled.
- The message switch and buffer (MSB) of the linkset must be defined, for example, it must have at least one link in it.
- The linkset must be on the same network as the routeset.
- The routes (linkset) selected must be on the same MSB as the routeset.
- There can be a maximum of six routes in a routeset.
- A route cannot be added twice to the routeset.
- All routes entered must be unique within the routeset.
- Only the first route of any routeset can be an associated route. This is a system restriction.

### **Modifying a routeset in table C7RTESET**

To modify a routeset, the routeset must first be taken offline. The routeset is keyed on the routeset name.

The exception occurs when attempting to delete a higher cost route from a routeset. If the linkset of the higher cost route is offline, you can delete the route without taking the routeset offline.

The DPC cannot be changed in order to modify this field. The routeset must be deleted and re-added with the new DPC.

The network name cannot be changed. The routeset must be deleted and re-added with a new name.

To change the linksets in the routeset, a new list of linksets is entered. The linksets are listed in order of priority. The conditions and restrictions that apply to adding a routeset in table C7RTESET also apply to modifying a

---

**C7RTESET** (continued)

---

routeset in table C7RTESET. Refer to the previous section, “Adding a routeset to table C7RTESET”.

**Deleting a routeset from table C7RTESET**

Before deleting a tuple from table C7RTESET, delete all references to the routeset from the following tables in the following order:

1. C7GTT
2. C7GTTTYPE
3. C7RPLSSN
4. C7LOCSSN
5. C7RSSCRN
6. C7NETSSN
7. C7TRKMEM

After deleting all references to the routeset, take the routeset offline. The routeset must be identified by a routeset name.

A routeset can be deleted without deleting the linksets defined within it. Linksets may be a part of many routesets.

**Datafill sequence and meaning**

The following tables must be datafilled before table C7RTESET:

- C7LKSET
- C7NETWRK

**Table size**

0 to 255 tuples without external routing.

0 to 511 with external routing enabled (for JPN-ISUP C7Routeset Expansion limitation configurations only).

0 to 2047 tuples for expanded routesets in an SSP office, a CCS7 multiple network address (MNA7) DMS INode, or an STP.

**Note 1:** Expanded routeset capability is controlled by software optionality control (SOC). Refer to the *Software Optionality Control User Manual*, 297-8991-901, for more information on using SOC.

**Note 2:** External routing must be enabled when more than 255 routeset tuples are required for the SSP or INode.



**C7RTESET** (continued)

Memory allocation is fixed for the maximum table size.

**Datafill**

The following tables list datafill for table C7RTESET.

**Field descriptions (Sheet 1 of 3)**

Field	Subfield	Entry	Explanation and action
ROUTESET		see subfield	<i>Routeset key</i> This field, which is the key to table C7RTESET, consists of subfield DESTNAME.
	DESTNAME	alphanumeric (1 to 16 characters)	<i>Routeset name</i> Enter a routeset name that is unique to the switching office. A routeset describes a collection of routes within a specific network.
NETNAME		alphanumeric (1 to 16 characters)	<i>Network name</i> This field identifies the network to which a destination point code (DPC) corresponds. Enter a network name that is unique to the switching office. This name must be previously datafilled in table C7NETWRK.  CCS7 linkset names can be numeric character strings. For example, a network can have the name of 99 999. To post a numerically named linkset at the appropriate MAP level, the name must be enclosed in single quotation marks ( ` ` ). For numerically named linksets that are longer than seven characters, no quotation marks are required, for example, linkset name 12345678 requires no quotation marks to post the linkset at the MAP level.

**C7RTESET** (continued)**Field descriptions (Sheet 2 of 3)**

<b>Field</b>	<b>Subfield</b>	<b>Entry</b>	<b>Explanation and action</b>
TFPBCAST		Y or N	<p><i>Transfer prohibited broadcast</i></p> <p>This field determines if a transfer prohibited (TFP) or transfer cluster prohibited (TCP) message is broadcast to all adjacent signaling points when the routeset becomes unavailable.</p> <p>If the switching unit is a signaling transfer point (STP) and a TFP or TCP must be broadcast to adjacent signaling points when the routeset becomes unavailable, enter Y.</p> <p>If no TFP or TCP broadcast is required or if the switching unit is not an STP, enter N. For Japan Public Network 7 (JPN7) networks, the only valid entry is N.</p>

**C7RTESET** (continued)

## Field descriptions (Sheet 3 of 3)

Field	Subfield	Entry	Explanation and action
DPC		see subfields	<p><i>Destination point code</i></p> <p>This field, which is a unique address given to each signaling DPC in the network, consists of subfield NETTYPE and refinements that depend on the NETTYPE entry value. The refinements define the point code of the destination office to which the routeset establishes signaling paths.</p> <p>Point codes within the same network must be unique.</p> <p>The DPC of the routeset must differ from the point code of the network to which the routeset belongs. This point code is found by comparing the network name of the routeset found in field NETNAME in table C7RTESET with the same network name in field NETNAME in table C7NETWRK.</p>
	NETTYPE	ANSI7, CCITT7, JPN7, NTC7, or TTC7	<p><i>Network type</i></p> <p>The entry value for this field determines the DPC format variant. Most switches have only one network type defined. Gateway switches that interface between two or more network types have more than one type defined.</p> <p>If the network type is the North American variant, enter ANSI7 and datafill subfield PC.</p> <p>If the network type is the international variant, enter CCITT7 and datafill subfield FORMAT and its refinements.</p> <p>If the network type is Japan Public Network 7, enter JPN7 and datafill subfield PC.</p> <p>If the network type is NTC7 variant, enter NTC7 and datafill subfield PC.</p> <p>If the network type is Telecommunication Technology Committee 7 (used in Japan for New Common Carriers [NCC]), enter TTC7 and datafill subfields MAINAREA, SUBAREA, and AREAUNIT described later in this table.</p>

**C7RTESET** (continued)**NETTYPE = ANSI7**

If the entry in field NETTYPE is ANSI7, datafill subfield PC.

**Field descriptions for conditional datafill**

Field	Subfield or refinement	Entry	Explanation and action
	PC	numeric (vector of up to three numeric values, 0 to 255)	<p><i>Point code</i></p> <p>Field PC is a vector of up to three values that make up the point code for the destination. This vector must be unique within the specified network.</p> <p><b>Note:</b> This field is different from the PC field that applies to CCITT7 networks with a CCITT format of BASIC.</p> <p>For ANSI7 networks, the vector consists of the following values:</p> <ul style="list-style-type: none"> <li>• The first value is the network identifier number that is assigned to the office and the specified network.</li> <li>• The second value is the number of the cluster in the network identifier that is assigned to the office and the specified network.</li> <li>• The third value is the number of the member in the cluster that is assigned to the office and the specified network.</li> </ul> <p>Enter one, two, or three values to specify the PC vector. If the field contains one or two values, the vector must be terminated by a \$. If the field contains three values (a full point code combination), a \$ is not needed to end the vector. Each entry must be separated from the next by a blank space.</p>

**C7RTESET** (continued)**NETTYPE = CCITT7**

If the entry in field NETTYPE is CCITT7, datafill subfield FORMAT and the appropriate refinements.

**Field descriptions for conditional datafill (Sheet 1 of 3)**

Field	Subfield	Entry	Explanation and action
	FORMAT	AUSTRIA, BASIC, CHINA, GERMANY, INTL, or TURK	<p><i>CCITT format</i></p> <p>This field specifies the CCITT7 point code refinements for the network.</p> <p>If the point code used is for Austria, enter AUSTRIA and datafill subfields ZONE, REGION, and SIGPOINT.</p> <p>If the point code used is based on one field, enter BASIC and datafill subfield PC.</p> <p>If the point code used is for China, enter CHINA and datafill subfields ZONE, EXCHANGE, and SIGPOINT.</p> <p>If the point code used is for Germany, enter GERMANY and datafill subfields NUMAREA, HVST, KVST, and SIGPOINT.</p> <p>If the point code used is international, enter INTL and datafill subfields ZONE, AREANETW, and SIGPOINT.</p> <p>If the point code used is for Turkey, enter TURK and datafill subfields ZONE, REGION, and SIGPOINT.</p>
	ZONE	0 to 31	<p><i>Zone identifier</i></p> <p>This field specifies the zone identifier that is assigned to the destination office and the specified network.</p> <p>If the entry subfield FORMAT is AUSTRIA, enter a number in the range 0 to 31.</p> <p>If the entry in subfield FORMAT is CHINA, enter a number in the range 0 to 15.</p> <p>If the entry in subfield FORMAT is INTL, enter a number in the range 0 to 7.</p> <p>If the entry in subfield FORMAT is TURK, enter a number in the range 0 to 15.</p>

**C7RTESET** (continued)**Field descriptions for conditional datafill (Sheet 2 of 3)**

<b>Field</b>	<b>Subfield</b>	<b>Entry</b>	<b>Explanation and action</b>
	AREANETW	0 to 255	<i>Area/network identifier</i> If the entry in subfield FORMAT is INTL, enter the number of the area/network identifier in the zone that is assigned to the destination office for the specified network.
	REGION	0 to 15	<i>Region identifier</i> If the entry in subfield FORMAT is AUSTRIA, enter the number of the region identifier in the zone that is assigned to the destination office for the specified network.  If the entry in subfield FORMAT is TURK, enter a value in the range 0 to 7.
	EXCHANGE	0 to 127	<i>Exchange</i> If the entry in subfield FORMAT is CHINA, enter the number of the exchange in the zone that is assigned to the destination office for the specified network.
	NUMAREA	00 to 15	<i>Numbering Area</i> If the entry in subfield FORMAT is GERMANY, enter the area number assigned to the office.
	HVST	0 to 7	<i>HVSt</i> If the entry in subfield FORMAT is GERMANY, enter the HVSt area assigned to the office.
	KVST	00 to 15	<i>KVSt</i> If the entry in subfield FORMAT is GERMANY, enter the KVSt area assigned to the office.
	SIGPOINT	0 to 127	<i>Signal point identifier</i> If the entry in subfield FORMAT is INTL, enter a numeric value between 0 and 7 for the signal point in the area/network that is assigned to the destination office for the specified network.  If the entry in subfield FORMAT is AUSTRIA, enter a numeric value between 0 and 31 for the signal point in the region that is assigned to the destination office for the specified network.

**C7RTESET** (continued)

## Field descriptions for conditional datafill (Sheet 3 of 3)

Field	Subfield	Entry	Explanation and action
	PC	0 to 16383	<p>If the entry in subfield FORMAT is CHINA, enter a numeric value between 0 and 7 for the signal point in the exchange that is assigned to the destination office for the specified network.</p> <p>If the entry in subfield FORMAT is GERMANY, enter a numeric value between 0 and 7 specifying the signal point code of the exchange.</p> <p>If the entry in subfield FORMAT is TURK, enter a value in the range 0 to 127.</p> <p><i>Point code</i></p> <p>If the entry in subfield FORMAT is BASIC, enter the DPC number for a basic CCITT7 network.</p>

**C7RTESET** (continued)**NETTYPE = NTC7 or JPN7**

If the entry in field NETTYPE is NTC7 or JPN7, datafill subfield PC.

**Field descriptions for conditional datafill**

Field	Subfield	Entry	Explanation and action
	PC	numeric (vector of up to three values, 0 to 255)	<p><i>Point code</i></p> <p>Field PC is a vector of up to three values that make up the point code for the destination. This vector must be unique within the specified network.</p> <p><b>Note:</b> This field is different from the PC field that applies to CCITT7 networks with a CCITT format of BASIC.</p> <p>The vector consists of the following values:</p> <ul style="list-style-type: none"> <li>• The first value corresponds to the main area that is assigned to the office and the specified network.</li> <li>• The second value corresponds to the subarea in the main area that is assigned to the office and the specified network.</li> <li>• The third value corresponds to the area unit in the subarea that is assigned to the office and the specified network.</li> </ul> <p>Enter one, two, or three values to specify the PC vector. If the field contains one or two values, the vector must be terminated by a \$. If the field contains three values (a full point code combination), a \$ is not needed to end the vector. Each entry must be separated from the next by a blank space.</p>



**C7RTESET** (continued)**NETTYPE = TTC7**

If the entry in field NETTYPE is TTC7, datafill subfields MAINAREA, SUBAREA, and AREAUNIT.

**Field descriptions for conditional datafill**

Field	Subfield	Entry	Explanation and action
	MAINAREA	0 to 31	<i>Main area</i> Enter the number of the main area that is assigned to the destination office and the specified network.
	SUBAREA	0 to 15	<i>Subarea</i> Enter the number of the subarea in the main area that is assigned to the destination office and the specified network.
	AREAUNIT	0 to 127	<i>Area unit</i> Enter the number of the area unit in the subarea that is assigned to the destination office and the specified network.

**For all NETTYPE values**

For all subfield NETTYPE values, datafill the following additional field and subfields.

**Field descriptions (Sheet 1 of 2)**

Field	Subfield	Entry	Explanation and action
ROUTES		see subfields (vector of up to 6 elements)	<i>Signaling routes</i> This field consists of subfields LINKSET and COST. For JPN7 networks, a maximum of two routes can be datafilled.

**C7RTESET** (continued)**Field descriptions (Sheet 2 of 2)**

Field	Subfield	Entry	Explanation and action
	LINKSET	alphanumeric (1 to 16 characters)	<i>Linkset name</i> Enter the linkset name, previously defined in table C7LKSET, that makes up part of the ROUTESET.  If Signaling Engineering and Administration System (SEAS) is present, the linkset name must be 8 characters.
	COST	0 to 99	<i>Cost</i> Enter the relative cost of using this route. Each route must have a cost equal to or greater than the cost of the route defined before it. This also defines the priority of the routes in the routeset.  JPN7 networks do not support combined linksets. For JPN7 networks, enter 0 (zero).

**Datafill example**

The following example shows sample datafill for table C7RTESET.

This example has the following requirements:

- Two routesets are used: C7RTESET1 and C7RTESET2.
- The network name used by routeset C7RTESET1 is C7NETWRK1.
- The network name used by routeset C7RTESET2 is C7NETWRK2.
- Both routesets have a network type of ANSI7.
- The DPC for C7RTESET1 contains network value of 4.
- The DPC for C7RTESET2 contains network and cluster values of 1 and 2.
- The route for C7RTESET1 is associated with linkset C7LKSET1.
- The route for C7RTESET2 is associated with linkset C7LKSET2.

**C7RTESET** (continued)**MAP display example for table C7RTESET**

ROUTESET	NETNAME	TFPBCAST	DPC	ROUTES
C7RTESET1	C7NETWRK1	N ANS17 ( 4) \$		( C7LKSET1 4) \$
C7RTESET2	C7NETWRK2	N ANS17 ( 1) ( 2) \$		( C7LKSET2 5) \$

**MAP display example for table C7RTESET when USP\_ACTIVE\_IN\_NETWORK is set to Y.**

ROUTESET	NETNAME	TFPBCAST	DPC	ROUTES
TEST_RTE	NEW_TESTNET	N ANS17 (1) (2) (3) \$		

**Table history****MMP15**

Added FORMAT TURK for feature 59022376.

**MSH14**

Message added to direct the user to the GUI on the USP for access to table data when office parameter USP\_ACTIVE\_IN\_NETWORK is set to Y.

**CSP14**

Error message added for ITU and NTC7 networks. The message appears when you try to add an equal cost route and one of the linksets in the combined linkset has more than eight A, E, or F links.

**CSP10**

Added error messages that appear when adding or removing the highest cost route in a routeset if the routeset is not offline.

---

**C7RTESET** (continued)

---

**TL08**

Table size increased to a maximum of 2047 routesets on an MNA7 DMS INode when external routing is enabled.

**TL06**

Table size increased to a maximum of 511 routesets on an STP/SSP INode when external routing is enabled.

**Supplementary information**

This section provides information on datafilling table C7RTESET for specific applications, and product descriptive information that is related to table C7RTESET.

**Error messages**

The following error message appears if operating company personnel attempt to add or remove the highest cost linkset that is not offline.

```
Attempt to add/delete the highest cost route. LINKSET must be offline.
```

The following error message appears if operating company personnel attempt to add or remove a linkset that is not the highest cost route in the specified routeset.

```
Linkset is not the highest cost route. ROUTESET must be offline.
```

The following error message appears if operating company personnel attempt to add or remove a linkset that is a part of a combined linkset.

```
Linkset is part of a combined linkset. ROUTESET must be offline.
```

The following error message appears if operating company personnel attempt to delete the only route in a routeset.

```
ROUTESET must have at least one LINKSET.
```

The following error message appears if operating company personnel try to add a linkset that is a part of a combined linkset (equal cost route) and either of the linksets has more than eight A, E, or F links.

```
Combined linkset not allowed. Linkset <linkset_name> exceeds link limit of 8.
```

**Note:** This error message applies to ITU and NTC7 networks.

## **C7RTESET** (continued)

---

### **STP route management functions**

The STP route management functions differ from signaling point (SP) route management functions in the following ways:

- STPs send TFP (transfer prohibited) messages.
- STPs send TFA (transfer allowed) messages.
- STPs send TFR (transfer restricted) messages.
- STPs send TCP (transfer cluster prohibited) messages.
- STPs send TCA (transfer cluster allowed) messages.
- STPs send TCR (transfer cluster restricted) messages.
- STPs send TFC (transfer controlled) messages.
- STPs must handle all signaling routeset test messages.

### **Transfer messages**

Transfer messages are sent from an STP when the STP determines that routing to a destination has been affected by an event in the network. Service switching points (SSP) and service control points (SCP) do not generate these messages because they do not transfer messages through the network.

Some examples of events and the possible messages sent are as follows:

Linkset failure:

- TFP (Transfer Prohibited) or TCP is sent to indicate current STP is unavailable to route messages.
- TFR (Transfer Restricted) or TCR is sent to indicate messages are being routed via an alternate STP.

Linkset restored:

- TFA (Transfer Allowed) or TCA is sent to indicate a message route is restored and available.
- Nothing is sent if the route is an alternate.

Link restored:

- TFA or TCA is sent to indicate a link is restored and available.
- Nothing is sent if the link is an alternate.

---

**C7RTESET** (end)

---

TFP received:

- TFR or TCR is sent to confirm STP is unavailable to route messages.
- TFP or TCP is sent to confirm that messages are being routed via an alternate STP.

Field TFPBCAST, which only applies to an STP, determines if a TFP or TCP message is broadcast to all adjacent signaling points. If the field is set to Y, a TFP or TCP message is broadcast. If it is set to N, message is not broadcast.

For non-STP switching units, the recommended entry value is N (however, it should be noted that Y is also a valid entry value since this field is not used within routeset management).

## C7TIMER

---

### Table name

Common Channel Signaling 7 Timer Table

### Functional description

Table C7TIMER contains the timers for message transfer part (MTP) levels two and three. The table is divided into four sets or groups of tuples: Q703, Q704, Q707, and the signaling ATM adaptation layer (SAAL) level for high-speed links (HSL). Each tuple in a set is accessed by its index.

Datafill for table C7TIMER includes the following items:

- datafill of all Q704 timers for each linkset
- datafill of Q707 timers for each link
- datafill of SAAL timers for each SAAL link
- datafill of Q703 timers for each MTP2 link

The following figure illustrates the dependencies between tables C7LKSET, C7LINK, and C7TIMER.

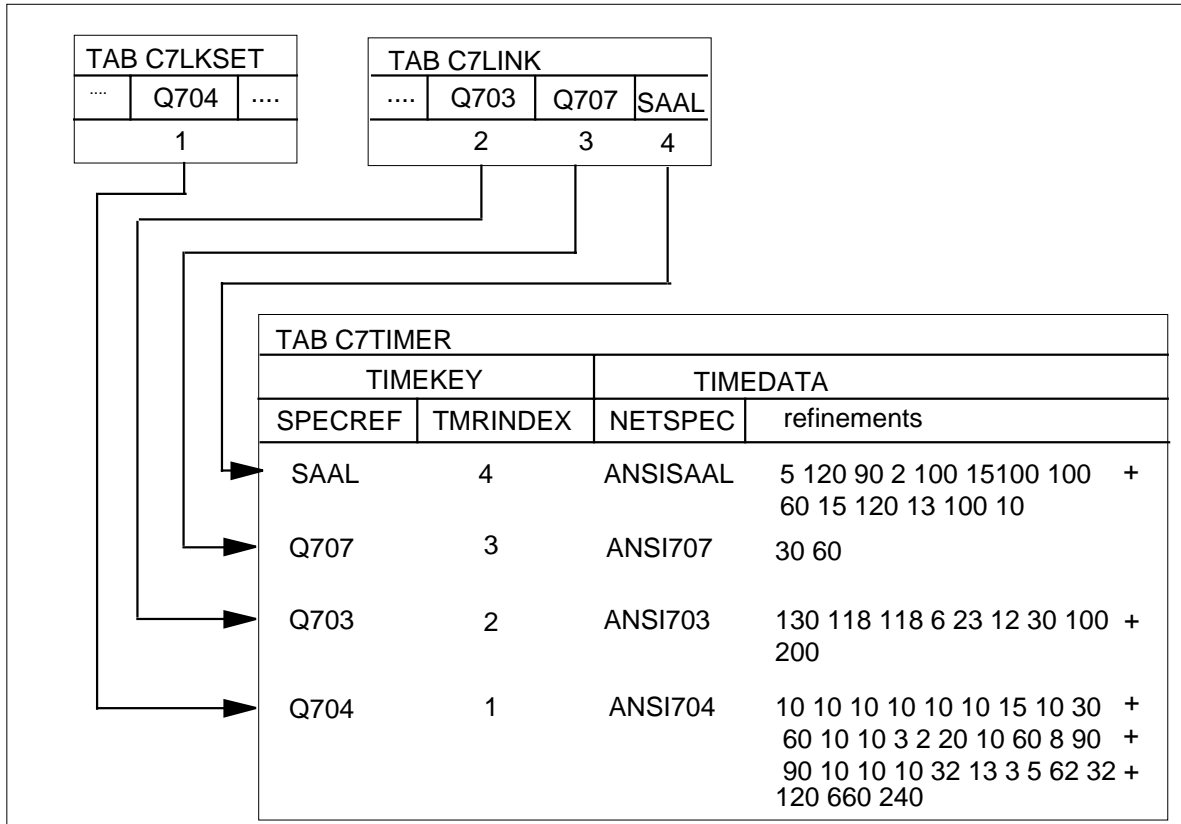
**C7TIMER** (continued)**Timer table control dependencies**

The following is a brief explanation of the figure above:

- Field SPECREF indicates the set of specification reference timers that is accessed. The four sets of reference timers are Q703, Q704, Q707 and SAAL.
- Field TMRINDEX points to a particular entry in a SPECREF set.
- Field NETSPEC indicates the network type and the timer values used.

**Adding, modifying, and deleting entries in table C7TIMER**

Table C7TIMER is not write protected. Operating companies can change timer values in this table to suit their needs. Consult Nortel's engineering



## C7TIMER (continued)

---

office for information concerning these timer values and how they can be modified.



### **CAUTION**

#### **Possible system disruptions and system failure**

Changing table C7TIMER timers from the recommended values to other values can cause system disruptions and possible system failure. Caution must be used when changing these timer values from the defaults.

### **Adding a set of timers**

Fields SPECREF and TMRINDEX are used to add timers to table C7TIMER. Field SPECREF identifies the timer specification set to be accessed and field TMRINDEX uniquely identifies the entries within the given SPECREF. Range checking ensures that the timer value does not go outside the timer limits specified for the network type. An entry must exist in table C7TIMER before it can be referenced by field Q704 in table C7LKSET and fields Q703, Q707, and SAAL\_INDEX in table C7LINK.

### **Modifying a timer table entry that is not in use**

If an entry in table C7TIMER is not referenced by any entry in tables C7LINK or C7LKSET, it is not in use. Any entry in table C7TIMER that is not in use can be modified.

### **Deleting a timer table entry that is not in use**

Any entry in table C7TIMER that is not in use can be deleted.

### **Modifying a timer table entry that is in use**

The following rules apply for modification of a timer table entry that is in use:

- All table C7LINK links that reference a Q703, Q707 or SAAL table entry must be offline for the entry to be modified. The links obtain the new timer values when they are activated.
- All table C7LKSET linksets that reference a Q704 table entry must be offline for the entry to be modified except for MTP Restart timers (T22 to T30) which can be changed when the linksets are in service. The values (except for the MTP Restart timers T22 to T30) are sent to all peripheral modules connected to links in the affected linkset, and the stored values are updated.

---

**C7TIMER** (continued)

---

**Deleting a timer table entry that is in use**

The following rules apply for deletion of a timer table entry that is in use:

- Prior to deleting a Q703, Q707, or SAAL table entry, all links in table C7LINK that reference the entry must be taken offline and changed to reference a different tuple in table C7TIMER. When no table C7LINK entries reference the tuple in table C7TIMER, it can be deleted.
- Prior to deleting a Q704 table entry, all linksets in table C7LKSET that reference a Q704 table entry must be taken offline and changed to reference a different table C7TIMER tuple. When no table C7LKSET entries reference the tuple in table C7TIMER, it can be safely deleted.

**Modifying a large number of timers**

The value of a timer cannot be changed unless all links that reference the timer tuple are offline. If a large number of timers need to be changed, taking the links offline results in an unacceptable service interruption.

The preferred approach is to add a new timer tuple, then change the links or linksets one-by-one to use the new tuple. Then only one link or linkset is temporarily out of service.

**Datafill sequence and implications**

There is no requirement to datafill other tables before table C7TIMER.

The following tables must be datafilled after table C7TIMER:

- C7LINK
- C7LKSET
- C7NETWRK

A table C7TIMER tuple for the Q703, Q704, and Q707 set types must exist before the entries in fields Q703 and Q707 of table C7LINK and field Q704 of table C7LKSET can reference it.

**Table size**

0 to 96 tuples

The maximum SPECREF set size is 32 tuples for each SPECREF. The minimum table size with no active links is 0 tuples. The minimum table size with at least one active link is 3 tuples. If only high-speed links (HSL) are present, only 1 SAAL tuple is required. The minimum SPECREF set size with at least one active link is 1 tuple.

**C7TIMER** (continued)**Datafill**

The following table lists datafill for table C7TIMER.

**Field descriptions (Sheet 1 of 4)**

<b>Field</b>	<b>Subfield or refinement</b>	<b>Entry</b>	<b>Explanation and action</b>
TIMEKEY		see subfields	<i>Timer key</i>  This field, which is the key to table C7TIMER, consists of subfields SPECREF and TMRINDEX.
	SPECREF	Q703, Q704, Q707 or SAAL	<i>Specification reference</i>  Enter Q703, Q704, Q707, or SAAL to specify the set of specification reference timers.
	TMRINDEX	0 to 31	<i>Timer index</i>  Enter a number to specify a C7TIMER index value that can be referenced by tables C7LKSET and C7LINK.
TIMEDATA		see subfields	<i>Timer data</i>  This field consists of subfield NETSPEC and refinements.

**C7TIMER** (continued)

## Field descriptions (Sheet 2 of 4)

Field	Subfield or refinement	Entry	Explanation and action
	NETSPEC	ANSI703 ANSI704 ANSI707 ANSISAAL CCITT703 CCITT704 CCITT707 NTC703 NTC704 NTC707 JPN703 JPN704 JPN707 TTC703 TTC704 TTC707	<p><i>Network type and specification reference</i></p> <p>Enter the network type and the last two digits of the specification reference.</p> <p><b>Note:</b> Network type ANSISAAL does not require the last two digits of the specification reference.</p> <p>If the network is the North American variant (ANSI7) and the entry in field SPECREF is Q703, enter ANSI703 and datafill refinements described in the table of section "NETSPEC = ANSI703".</p> <p>If the network is the North American variant (ANSI7) and the entry in field SPECREF is Q704, enter ANSI704 and datafill refinements described in the table of section "NETSPEC = ANSI704".</p> <p>If the network is the North American variant (ANSI7) and the entry in field SPECREF is Q707, enter ANSI707 and datafill refinements described in the table of section "NETSPEC = ANSI707".</p> <p>If the network is the North American variant (ANSI7) and the entry in field SPECREF is SAAL, enter ANSISAAL and datafill refinements in the table of section "NETSPEC = ANSISAAL".</p> <p>If the network is CCITT7 and the entry in field SPECREF is Q703, enter CCITT703 and datafill refinements described in then table of section "NETSPEC = CCITT703".</p> <p>If the network is CCITT7 and the entry in field SPECREF is Q704, enter CCITT704 and datafill refinements described in the table of section "NETSPEC = ANSI704".</p>

**C7TIMER** (continued)

**Field descriptions (Sheet 3 of 4)**

Field	Subfield or refinement	Entry	Explanation and action
			<p>If the network is CCITT7 and the entry in field SPECREF is Q707, enter CCITT707 and datafill refinements described in the table of section "NETSPEC = CCITT707".</p>
			<p>If the network is NTC7 and the entry in field SPECREF is Q703, enter NTC703 and datafill refinements described in the table of section "NETSPEC = NTC703".</p>
			<p>If the network is NTC7 and the entry in field SPECREF is Q704, enter NTC704 and datafill refinements described in the table of section "NETSPEC = NTC704".</p>
			<p>If the network is NTC7 and the entry in field SPECREF is Q707, enter NTC707 and datafill refinements described in the table of section "NETSPEC = NTC707".</p>
			<p>If the network is the Japan Public Network variant (JPN7) and the entry in field SPECREF is Q703, enter JPN703 and datafill refinements described in the table of section "NETSPEC = JPN703".</p>
			<p>If the network is the Japan Public Network variant (JPN7) and the entry in field SPECREF is Q704, enter JPN704 and datafill refinements described in the table of section "NETSPEC = JPN704".</p>
			<p>If the network is the Japan Public Network variant (JPN7) and the entry in field SPECREF is Q707, enter JPN707 and datafill refinements described in the table of section "NETSPEC = NTC707".</p>
			<p>If the network is the Japanese variant (TTC7) and the entry in field SPECREF is Q703, enter TTC703 and datafill refinements described in the table of section "NETSPEC = TTC703".</p>

**C7TIMER** (continued)**Field descriptions (Sheet 4 of 4)**

Field	Subfield or refinement	Entry	Explanation and action
			<p>If the network is the Japanese variant (TTC7) and the entry in field SPECREF is Q704, enter TTC704 and datafill refinements described in table of section "NETSPEC = TTC704".</p> <p>If the network is the Japanese variant (TTC7) and the entry in field SPECREF is Q707, enter TTC707 and datafill refinements described in the table of section "NETSPEC = TTC707".</p>

**NETSPEC = ANSI703**

If the entry in field NETSPEC is ANSI703, datafill refinements T1, T2, T3, T4E, T4N, T5, T6, and T7 as described in the following table.

When a new tuple is added in table C7TIMER, the default values from DEFDATA are automatically added. When the entry in field NETSPEC is changed, the default values from DEFDATA are not automatically entered.

**C7TIMER** (continued)

The value for each timer must be separated from the next by a single space.

**Field descriptions for conditional datafill (Sheet 1 of 2)**

Field	Subfield or refinement	Entry	Explanation and action
	T1	100 to 3200	<p><i>Aligned ready timer</i></p> <p>Enter the aligned ready time-out value in 100-ms units.</p> <p>The default time-out value is 130 (13 s).</p>
	T2	50 to 3000	<p><i>Not-aligned timer</i></p> <p>Enter the not-aligned time-out value in 100-ms units to define the period that the system waits for the alignment process to start at the other end of the signaling link before timing out (for example, when waiting for service information octet (SIO), normal alignment (SIN), or emergency alignment (SIE) status indications).</p> <p>Assign a different T2 value to each end of the Common Channel Signaling 7 (CCS7) signaling link to assist in the alignment process. The recommended values are 118 for one end of the linkset and 235 for the other end of the linkset.</p> <p>The default value is 118 (11.8 s).</p>
	T3	10 to 3000	<p><i>Aligned timer</i></p> <p>Enter the aligned time-out value in 100-ms units.</p> <p>The default time-out value is 118 (11.8 s).</p>
	T4E	4 to 150	<p><i>Emergency proving period timer</i></p> <p>Enter the emergency proving period time-out value in 100-ms units.</p> <p>The default time-out value is 6 (600 ms).</p>
<p><b>Note:</b> The above timers are described in the appropriate sections of the relevant CCS7 signaling specifications.</p>			

**C7TIMER** (continued)**Field descriptions for conditional datafill (Sheet 2 of 2)**

Field	Subfield or refinement	Entry	Explanation and action
	T4N	15 to 600	<i>Normal proving period timer</i> Enter the normal proving period time-out value in 100-ms units. The default time-out value is 23 (2.3 s).
	T5	8 to 500	<i>Sending status indication busy timer</i> Enter the sending status indication busy (SIB) time-out value in 10-ms units. The default time-out value is 20 (200 ms).
	T6	20 to 750	<i>Remote congestion timer</i> Enter the remote congestion time-out value in 100-ms units. The default time-out value is 30 (3 s).
	T7	50 to 2500	<i>Excessive delay of acknowledgement timer</i> Enter the excessive delay of acknowledgement time-out value in 10-ms intervals. The default time-out value is 100 (1 s).
<b>Note:</b> The above timers are described in the appropriate sections of the relevant CCS7 signaling specifications.			

**NETSPEC = CCITT703**

If the entry in field NETSPEC is CCITT703, datafill refinements T1, T2, T3, T4E, T4N, T5, T6, and T7 as described in the following table.

When a new tuple is added in table C7TIMER, the default values from DEFDATA are automatically added. When the entry in field NETSPEC is changed, the default values from DEFDATA are not automatically entered.



**C7TIMER** (continued)

The value for each timer must be separated from the next by a single space.

**Field descriptions for conditional datafill (Sheet 1 of 2)**

Field	Subfield or refinement	Entry	Explanation and action
	T1	100 to 3200	<p><i>Aligned ready timer</i></p> <p>Enter the aligned ready time-out value in 100-ms units.</p> <p>The default time-out value is 400 (40 s).</p>
	T2	50 to 3000	<p><i>Not-aligned timer</i></p> <p>Enter the not-aligned time-out value in 100-ms units to define the period that the system waits for the alignment process to start at the other end of the signaling link before timing out (for example, when waiting for service information octet (SIO), normal alignment (SIN), or emergency alignment (SIE) status indications).</p> <p>Assign a different T2 value to each end of the Common Channel Signaling 7 (CCS7) signaling link to assist in the alignment process. The recommended values are 50 (5 s) for one end of the linkset and 99 (9.9 s) for the other end of the linkset.</p> <p>The default value is 50 (5 s).</p>
	T3	10 to 3000	<p><i>Aligned timer</i></p> <p>Enter the aligned time-out value in 100-ms units.</p> <p>The default time-out value is 15 (1.5 s).</p>
	T4E	4 to 150	<p><i>Emergency proving period timer</i></p> <p>Enter the emergency proving period time-out value in 100-ms units.</p> <p>The default time-out value is 5 (500 ms).</p>
<p><b>Note:</b> The above timers are described in the appropriate sections of the relevant CCS7 signaling specifications.</p>			

**C7TIMER** (continued)**Field descriptions for conditional datafill (Sheet 2 of 2)**

Field	Subfield or refinement	Entry	Explanation and action
	T4N	15 to 600	<p><i>Normal proving period timer</i></p> <p>Enter the normal proving period time-out value in 100-ms units.</p> <p>The default time-out value is 82 (8.2 s).</p>
	T5	8 to 500	<p><i>Sending status indication busy timer</i></p> <p>Enter the sending status indication busy (SIB) time-out value in 10-ms units.</p> <p>The default time-out value is 20 (200 ms).</p>
	T6	20 to 750	<p><i>Remote congestion timer</i></p> <p>Enter the remote congestion time-out value in 100-ms units.</p> <p>The default time-out value is 30 (3 s).</p>
	T7	50 to 2500	<p><i>Excessive delay of acknowledgement timer</i></p> <p>Enter the excessive delay of acknowledgement time-out value in 10-ms intervals.</p> <p>The default time-out value is 100 (1 s).</p>
<p><b>Note:</b> The above timers are described in the appropriate sections of the relevant CCS7 signaling specifications.</p>			

**NETSPEC = NTC703**

If the entry in field NETSPEC is NTC703, datafill refinements T1, T2, T3, T4E, T4N, T5, T6, and T7 as described in the following table.

When a new entry is added in field NETSPEC, the default values from DEFDATA are automatically added. When the entry in field NETSPEC is changed, the default values from DEFDATA are not automatically entered.

**C7TIMER** (continued)

The value for each timer must be separated from the next by a single space.

**Field descriptions for conditional datafill (Sheet 1 of 2)**

Field	Subfield or refinement	Entry	Explanation and action
	T1	400 to 500	<p><i>Aligned ready timer</i></p> <p>Enter the aligned ready time-out value in 100-ms units.</p> <p>The default time-out value is 450 (45 s).</p>
	T2	50 to 1500	<p><i>Not-aligned timer</i></p> <p>Enter the not-aligned time-out value in 100-ms units to define the period that the system waits for the alignment process to start at the other end of the signaling link before timing out (for example, when waiting for service information octet (SIO), normal alignment (SIN), or emergency alignment (SIE) status indications).</p> <p>Assign a different T2 value to each end of the Common Channel Signaling 7 (CCS7) signaling link to assist in the alignment process.</p> <p>The default time-out value is 1320 (132 s).</p>
	T3	10 to 15	<p><i>Aligned timer</i></p> <p>Enter the aligned time-out value in 100-ms units.</p> <p>The default time-out value is 10 (1 s).</p>
	T4E	4 to 6	<p><i>Emergency proving period timer</i></p> <p>Enter the emergency proving period time-out value in 100-ms units.</p> <p>The default time-out value is 5 (500 ms).</p>
	T4N	75 to 95	<p><i>Normal proving period timer</i></p> <p>Enter the normal proving period time-out value in 100-ms units.</p> <p>The default time-out value is 82 (8.2 s).</p>
<p><b>Note:</b> The above timers are described in the appropriate sections of the relevant CCS7 signaling specifications.</p>			

**C7TIMER** (continued)

## Field descriptions for conditional datafill (Sheet 2 of 2)

Field	Subfield or refinement	Entry	Explanation and action
	T5	8 to 12	<p><i>Sending status indication busy timer</i></p> <p>Enter the sending status indication busy (SIB) time-out value in 10-ms units.</p> <p>The default time-out value is 10 (100 ms).</p>
	T6	30 to 60	<p><i>Remote congestion timer</i></p> <p>Enter the remote congestion time-out value in 100-ms units.</p> <p>The default time-out value is 50 (5 s).</p>
	T7	50 to 200	<p><i>Excessive delay of acknowledgement timer</i></p> <p>Enter the excessive delay of acknowledgement time-out value in 10-ms intervals.</p> <p>The default time-out value is 200 (2 s).</p>
<p><b>Note:</b> The above timers are described in the appropriate sections of the relevant CCS7 signaling specifications.</p>			

**NETSPEC = JPN703**

If the entry in field NETSPEC is JPN703, datafill refinements T1, T2, T3, T4E, T5, T6, T7, and TF as described in the following table.

When a new entry is added in field NETSPEC, the default values from DEFDATA are automatically added. When the entry in field NETSPEC is changed, the default values from DEFDATA are not automatically entered.

**C7TIMER** (continued)

The value for each timer must be separated from the next by a single space.

**Field descriptions for conditional datafill (Sheet 1 of 2)**

Field	Subfield or refinement	Entry	Explanation and action
	T1	10 to 300	<p><i>Aligned ready timer</i></p> <p>Enter the aligned ready time-out value in 100-ms units.</p> <p>The default time-out value is 30 (3 s).</p>
	T2	50 to 4800	<p><i>Not-aligned timer</i></p> <p>Enter the not-aligned time-out value in 100-ms units to define the period that the system will wait for the alignment process to start at the other end of the signaling link before timing out (for example, when waiting for service information octet (SIO), normal alignment (SIN), or emergency alignment (SIE) status indications).</p> <p>Assign a different T2 value to each end of the CCS7 signaling link to assist in the alignment process.</p> <p>The default time-out value is 4800 (480 s).</p>
	T3	50 to 4800	<p><i>Aligned timer</i></p> <p>Enter the aligned time-out in 100-ms units.</p> <p>The default time-out value is 4800 (480 s).</p>
	T4E	4 to 30	<p><i>Emergency proving period timer</i></p> <p>Enter the emergency proving period time-out value in 100-ms units.</p> <p>The default time-out value is 30 (3 s).</p>
	T5	10 to 150	<p><i>Sending status indication busy timer</i></p> <p>Enter the sending status indication busy (SIB) time-out value in 10-ms units.</p> <p>The default time-out value is 20 (200 ms).</p>
<p><b>Note:</b> The above timers are described in the appropriate sections of the relevant CCS7 signaling specifications.</p>			

**C7TIMER** (continued)

## Field descriptions for conditional datafill (Sheet 2 of 2)

Field	Subfield or refinement	Entry	Explanation and action
	T6	30 to 200	<p><i>Remote congestion timer</i></p> <p>Enter the remote congestion time-out value in 100-ms units.</p> <p>The default time-out value is 200 (20 s).</p>
	T7	50 to 300	<p><i>Excessive delay of acknowledgement timer</i></p> <p>Enter the excessive delay of acknowledgement time-out value in 10-ms intervals.</p> <p>The default time-out value is 200 (2 s).</p>
	TF	1 to 252	<p><i>Flag count</i></p> <p>Enter the flag count value to specify the rate at which repeated link status signal units (LSSU) or fill-in signal units (FISU) are transmitted by the local signaling terminal (ST). This value indicates the number of flags.</p> <p>The default value is 137 (137 flags).</p> <p><b>Note:</b> The flag count value is specific to the JPN7 network.</p>
<p><b>Note:</b> The above timers are described in the appropriate sections of the relevant CCS7 signaling specifications.</p>			

**NETSPEC = TTC703**

If the entry in field NETSPEC is TTC703, datafill refinements T1, T2, T3, T4E, T5, T6, and T7 as described in the following table.

When a new entry is added in field NETSPEC, the default values from DEFDATA are automatically added. When the entry in field NETSPEC is changed, the default values from DEFDATA are not automatically entered.

**C7TIMER** (continued)

The value for each timer must be separated from the next by a single space.

**Field descriptions for conditional datafill (Sheet 1 of 2)**

Field	Subfield or refinement	Entry	Explanation and action
	T1	100 to 3200	<p><i>Aligned ready timer</i></p> <p>Enter the aligned ready time-out value in 100-ms units.</p> <p>The default time-out value is 130 (13 s).</p>
	T2	50 to 4800	<p><i>Not-aligned timer</i></p> <p>Enter the not-aligned time-out value in 100-ms units to define the time period that the system waits for the alignment process to start at the other end of the signaling link before timing out (for example, when waiting for service information octet (SIO), normal alignment (SIN), or emergency alignment (SIE) status indications).</p> <p>Enter a T2 different value at each end of the CCS7 signaling link to assist in the alignment process. The recommended values are 118 for one end of the linkset and 235 for the other end of the linkset.</p> <p>The default time-out value is 4800 (480 s).</p>
	T3	10 to 4800	<p><i>Aligned timer</i></p> <p>Enter the aligned time-out value in 100-ms units.</p> <p>The default time-out value is 4800 (480 s).</p>
	T4E	4 to 30	<p><i>Emergency proving period timer</i></p> <p>Enter the emergency proving period time-out value in 100-ms units.</p> <p>The default time-out value is 30 (3 s).</p>
<p><b>Note:</b> The above timers are described in the appropriate sections of the relevant CCS7 signaling specifications.</p>			

**C7TIMER** (continued)**Field descriptions for conditional datafill (Sheet 2 of 2)**

<b>Field</b>	<b>Subfield or refinement</b>	<b>Entry</b>	<b>Explanation and action</b>
	T5	8 to 500	<p><i>Sending status indication busy timer</i></p> <p>Enter the sending status indication busy (SIB) time-out value in 10-ms units.</p> <p>The default time-out value is 20 (200 ms).</p>
	T6	30 to 200	<p><i>Remote congestion timer</i></p> <p>Enter the remote congestion time-out value in 100-ms intervals.</p> <p>The default time-out value is 200 (20 s).</p>
	T7	50 to 300	<p><i>Excessive delay of acknowledgement timer</i></p> <p>Enter the excessive delay of acknowledgement time-out value in 10-ms units.</p> <p>The default time-out value is 200 (2 s).</p>
<p><b>Note:</b> The above timers are described in the appropriate sections of the relevant CCS7 signaling specifications.</p>			

**NETSPEC = ANSI704**

If the entry in field NETSPEC is ANSI704, datafill refinements T1, T2, T3, T4, T5, T6, T7, T8, T10, T11, T12, T13, T14, T15, T16, T17, T18, T19, T20, T21, T22, T23, T24, T25, T26, T27, T28, T29, T30, T31, T33, and T34 as described in the following table.

When a new entry is added in field NETSPEC, the default values from DEFDATA are automatically added. When the entry in field NETSPEC is changed, the default values from DEFDATA are not automatically entered.



**C7TIMER** (continued)

The value for each timer must be separated from the next by a single space.

**CAUTION****Nodal timers are automatically changed for all ANSI704 networks**

Timers T22, T23, T24, and T26 are nodal. Each nodal timer is to be datafilled the same in all ANSI704 networks. When one of these nodal timers is changed in one ANSI704 network, the following warning message is issued indicating it has been changed for all ANSI704 networks.

\*\*\*WARNING\*\*\*

Nodal timers must be the same in all tuples for a network  
All other tuples for this network type will be modified

**Field descriptions for conditional datafill (Sheet 1 of 7)**

Field	Subfield or refinement	Entry	Explanation and action
	T1	5 to 250	<i>Mis-sequence changeover timer</i> Enter the mis-sequence changeover time-out value in 100-ms units. The default time-out value is 10 (1 s).
	T2	5 to 250	<i>Changeover acknowledgement timer</i> Enter the changeover acknowledgement time-out value in 100-ms units. The default time-out value is 10 (1 s).
	T3	5 to 250	<i>Mis-sequence changeback timer</i> Enter the mis-sequence changeback time-out value in 100-ms units. The default time-out value is 10 (1 s).
<b>Note:</b> The above timers are described in the appropriate sections of the relevant CCS7 signaling specifications.			

**C7TIMER** (continued)**Field descriptions for conditional datafill (Sheet 2 of 7)**

Field	Subfield or refinement	Entry	Explanation and action
	T4	5 to 250	<p><i>Changeback acknowledgement timer (first attempt)</i></p> <p>Enter the changeback acknowledgement time-out value (first attempt) in 100-ms units.</p> <p>The default time-out value is 10 (1 s).</p>
	T5	5 to 250	<p><i>Changeback acknowledgement timer (second attempt)</i></p> <p>Enter the changeback acknowledgement time-out value (second attempt) in 100-ms units.</p> <p>The default time-out value is 10 (1 s).</p>
	T6	5 to 250	<p><i>Controlled rerouting timer</i></p> <p>Enter the controlled rerouting time-out value in 100-ms units.</p> <p>The default time-out value is 10 (1 s).</p>
	T7	10 to 400	<p><i>Signaling data link connection acknowledgement timer</i></p> <p>Enter the signaling data link connection acknowledgement time-out value in 100-ms units.</p> <p>The default time-out value is 15 (1.5 s).</p>
	T8	5 to 250	<p><i>Transfer prohibited timer</i></p> <p>Enter the transfer prohibited time-out value in 100-ms units.</p> <p>The default time-out value is 10 (1 s).</p>
<p><b>Note:</b> The above timers are described in the appropriate sections of the relevant CCS7 signaling specifications.</p>			

**C7TIMER** (continued)**Field descriptions for conditional datafill (Sheet 3 of 7)**

Field	Subfield or refinement	Entry	Explanation and action
	T10	20 to 750	<p><i>Signaling routeset test message timer</i></p> <p>Enter the signaling routeset test message time-out value in 1-s units.</p> <p>The default time-out value is 30 (30 s).</p> <p><b>Note:</b> The default time-out value must be increased to 60 (60 s) if more than 511 routesets are enabled with software optionality control (SOC).</p>
	T11	30 to 1700	<p><i>Transfer restricted timer</i></p> <p>Enter the transfer restricted time-out value in 1-s units.</p> <p>The default time-out value is 90 s.</p>
	T12	5 to 250	<p><i>Uninhibit acknowledgement timer</i></p> <p>Enter the uninhibit acknowledge time-out value in 100-ms units.</p> <p>The default time-out value is 10 (1 s).</p>
	T13	5 to 250	<p><i>Forced uninhibit timer</i></p> <p>Enter the forced uninhibit time-out value in 100-ms units.</p> <p>The default time-out value is 10 (1 s).</p>
	T14	2 to 80	<p><i>Inhibit acknowledgement message timer</i></p> <p>Enter the inhibit acknowledgement message time-out value in 1-s units.</p> <p>The default value is 3 (3 s).</p>
	T15	1 to 60	<p><i>Repeat routeset congestion test timer</i></p> <p>Enter the repeat routeset congestion test time-out value in 1-s units.</p> <p>The default time-out value is 2 (2 s).</p>
<p><b>Note:</b> The above timers are described in the appropriate sections of the relevant CCS7 signaling specifications.</p>			

**C7TIMER** (continued)**Field descriptions for conditional datafill (Sheet 4 of 7)**

Field	Subfield or refinement	Entry	Explanation and action
	T16	5 to 500	<p><i>Routeset congestion status update timer</i></p> <p>Enter the routeset congestion status update time-out value in 100-ms units.</p> <p>The default time-out value is 20 (2 s).</p>
	T17	5 to 250	<p><i>Initial alignment failure and link restart timer</i></p> <p>Enter the initial alignment failure and link restart time-out value in 100-ms units.</p> <p>The default time-out value is 10 (1 s).</p>
	T18	30 to 1500	<p><i>Transfer cluster restricted timer</i></p> <p>Enter the transfer cluster restricted time-out value in 1-s units.</p> <p>The default value is 60 (60 s).</p>
	T19	7 to 200	<p><i>Failed link craft referral timer</i></p> <p>Enter the failed link craft referral time-out value in 1-min units.</p> <p>The default value is 8 (8 min).</p>
	T20	70 to 2200	<p><i>Local inhibit test timer</i></p> <p>Enter the local inhibit test time-out value in 1-s units.</p> <p>The default value is 90 (90 s).</p>
	T21	70 to 2200	<p><i>Remote inhibit test timer</i></p> <p>Enter the remote inhibit test time-out value in 1-s units.</p> <p>The default value is 90 (90 s).</p>
	T22	1 to 60	<p><i>Signaling link available timer</i></p> <p>Enter the waiting for signaling links available at restarting node time-out value in 1-s units.</p> <p>One timer entered for the node.</p> <p>The default value is 40 (40 s).</p>

**Note:** The above timers are described in the appropriate sections of the relevant CCS7 signaling specifications.

**C7TIMER** (continued)**Field descriptions for conditional datafill (Sheet 5 of 7)**

Field	Subfield or refinement	Entry	Explanation and action
	T23	1 to 60	<p><i>Receiving TRA messages timer</i></p> <p>Enter the receiving TRA (traffic restart allowed) messages time-out value in 1-s units. One timer entered for the node.</p> <p>The default value is 10 (10 s).</p>
	T24	1 to 60	<p><i>Broadcasting status messages timer</i></p> <p>Enter the broadcasting status time-out value in 1-s units. One timer entered for the node.</p> <p>The default value is 10 (10 s).</p>
	T25	1 to 60	<p><i>Adjacent node waiting for TRA message timer</i></p> <p>Enter the adjacent node to restart node waiting for TRA (traffic restart allowed) message time-out value in 1-s units. One timer entered per linkset.</p> <p>The default value is 32 (32 s).</p>
	T26	5 to 20	<p><i>Waiting to repeat TRW message timer</i></p> <p>Enter the waiting to repeat TRW (traffic restart waiting) message time-out value in 1-s units. One timer entered for the node.</p> <p>The default value is 13 (13 s).</p>
	T27	2 to 5	<p><i>Minimum duration of unavailability for full restart timer</i></p> <p>Enter the minimum duration of unavailability for full restart time-out value in 1-s units. One timer entered for the node.</p> <p>The default value is 3 (3 s).</p>
<p><b>Note:</b> The above timers are described in the appropriate sections of the relevant CCS7 signaling specifications.</p>			

**C7TIMER** (continued)**Field descriptions for conditional datafill (Sheet 6 of 7)**

Field	Subfield or refinement	Entry	Explanation and action
	T28	1 to 60	<p><i>Adjacent node waiting for TRW message timer</i></p> <p>Enter the waiting for TRW (traffic restart waiting) message at node adjacent to restart node time-out value in 1-s units. One timer entered per linkset.</p> <p>The default value is 5 (5 s).</p>
	T29	60 to 90	<p><i>TRA message sent in response to unexpected TRA or TRW timer</i></p> <p>Enter the TRA (traffic restart allowed) message sent in response to unexpected TRA or TRW (traffic restart waiting) message time-out value in 1-s units. One timer entered per linkset.</p> <p>The default value is 62 (62 s).</p>
	T30	1 to 60	<p><i>Limit sending TFP and TFR in response to unexpected TRA or TRW timer</i></p> <p>Enter the limit sending of TFP (transfer prohibited) and TFR (transfer restricted) messages in response to unexpected TRA or TRW (traffic restart waiting) message time-out value in 1-s units. One timer entered per linkset.</p> <p>The default value is 32 (32 s).</p>
	T31	10 to 120	<p><i>Limit the time a link remains in false congestion</i></p> <p>Enter the maximum time a link will remain in false congestion before the system restarts it. Enter one timer per linkset. Enter the value in 1s units. The default value is 120 (120 s).</p>
<p><b>Note:</b> The above timers are described in the appropriate sections of the relevant CCS7 signaling specifications.</p>			

**C7TIMER** (continued)**Field descriptions for conditional datafill (Sheet 7 of 7)**

Field	Subfield or refinement	Entry	Explanation and action
	T33	60 to 660	<p><i>Link probation timer</i></p> <p>Enter the probation time for the link brought into service. If the link becomes system busy (SysB) before the expiration of this timer, the system starts timer T34. The link remains in SysB state until timer T34 expires.</p> <p>Enter the value in 1-s units. The default value is 660 (660 s).</p>
	T34	5 to 240	<p><i>Link penalty timer</i></p> <p>Enter the maximum time a link will remain in SysB state before the system tries to return the link to service.</p> <p>Enter the value in 1-s units. The default value is 240 (240 s).</p>
<p><b>Note:</b> The above timers are described in the appropriate sections of the relevant CCS7 signaling specifications.</p>			

**NETSPEC = CCITT704**

If the entry in field NETSPEC is CCITT704, datafill refinements T1, T2, T3, T4, T5, T6, T7, T8, T10, T11, T12, T13, T14, T15, T16, T17, T18, T19, T20, T21, T22, T23 and T24 as described in the following table.

When a new entry is added in field NETSPEC, the default values from DEFDATA are automatically added. When the entry in field NETSPEC is changed, the default values from DEFDATA are not automatically entered.

**C7TIMER** (continued)

The value for each timer must be separated from the next by a single space.

**CAUTION****Nodal timers are automatically updated for all non-ANSI704 networks**

Timers T18 and T20 are nodal. Each nodal timer is to be datafilled the same in all non-ANSI704 networks. When one of these nodal timers is changed in one non-ANSI704 network, the following warning message is issued indicating it has been changed for all non-ANSI704 networks.

\*\*\*WARNING\*\*\*

Nodal timers must be the same in all tuples for a network  
All other tuples for this network type will be modified

**Field descriptions for conditional datafill (Sheet 1 of 5)**

Field	Subfield or refinement	Entry	Explanation and action
	T1	5 to 250	<i>Mis-sequence changeover timer</i> Enter the mis-sequence changeover time-out value in 100-ms units. The default time-out value is 10 (1 s).
	T2	5 to 250	<i>Changeover acknowledgement timer</i> Enter the changeover acknowledgement time-out value in 100-ms units. The default time-out value is 10 (1 s).
	T3	5 to 250	<i>Mis-sequence changeback timer</i> Enter the mis-sequence changeback time-out value in 100-ms units. The default time-out value is 10 (1 s).
<b>Note:</b> The above timers are described in the appropriate sections of the relevant CCS7 signaling specifications.			



**C7TIMER** (continued)**Field descriptions for conditional datafill (Sheet 2 of 5)**

Field	Subfield or refinement	Entry	Explanation and action
	T4	5 to 250	<p><i>Changeback acknowledgement timer (first attempt)</i></p> <p>Enter the changeback acknowledgement time-out value (first attempt) in 100-ms units.</p> <p>The default time-out value is 10 (1 s).</p>
	T5	5 to 250	<p><i>Changeback acknowledgement timer (second attempt)</i></p> <p>Enter the changeback acknowledgement time-out value (second attempt) in 100-ms units.</p> <p>The default time-out value is 10 (1 s).</p>
	T6	5 to 250	<p><i>Controlled rerouting timer</i></p> <p>Enter the controlled rerouting time-out value in 100-ms units.</p> <p>The default time-out value is 10 (1 s).</p>
	T7	10 to 400	<p><i>Signaling data link connection acknowledgement timer</i></p> <p>Enter the signaling data link connection acknowledgement time-out value in 100-ms units.</p> <p>The default time-out value is 15 (1.5 s).</p>
	T8	5 to 250	<p><i>Transfer prohibited timer</i></p> <p>Enter the transfer prohibited time-out value in 100-ms units.</p> <p>The default time-out value is 10 (1 s).</p>
<p><b>Note:</b> The above timers are described in the appropriate sections of the relevant CCS7 signaling specifications.</p>			

**C7TIMER** (continued)**Field descriptions for conditional datafill (Sheet 3 of 5)**

Field	Subfield or refinement	Entry	Explanation and action
	T10	20 to 750	<p><i>Signaling routeset test message timer</i></p> <p>Enter the signaling routeset test message time-out value in 1-s units.</p> <p>The default time-out value is 30 (30 s).</p> <p><b>Note:</b> The default time-out value must be increased to 60 (60 s) if more than 511 routesets are enabled with software optionality control (SOC).</p>
	T11	30 to 1700	<p><i>Transfer restricted timer</i></p> <p>Enter the transfer restricted time-out value in 1-s units.</p> <p>The default time-out value is 90 (90 s).</p>
	T12	5 to 250	<p><i>Uninhibit acknowledgement timer</i></p> <p>Enter the uninhibit acknowledge time-out value in 100-ms units.</p> <p>The default time-out value is 10 (1 s).</p>
	T13	5 to 250	<p><i>Forced uninhibit timer</i></p> <p>Enter the forced uninhibit time-out value in 100-ms units.</p> <p>The default time-out value is 10 (1 s).</p>
	T14	2 to 80	<p><i>Inhibit acknowledgement message timer</i></p> <p>Enter the inhibit acknowledgement message time-out value in 1-s units.</p> <p>The default value is 3 (3 s).</p>
	T15	1 to 60	<p><i>Repeat routeset congestion test timer</i></p> <p>Enter the repeat routeset congestion test time-out value in 1-s units.</p> <p>The default time-out value is 2 (2 s).</p>
<p><b>Note:</b> The above timers are described in the appropriate sections of the relevant CCS7 signaling specifications.</p>			

**C7TIMER** (continued)**Field descriptions for conditional datafill (Sheet 4 of 5)**

Field	Subfield or refinement	Entry	Explanation and action
	T16	5 to 500	<p><i>Routeset congestion status update timer</i></p> <p>Enter the routeset congestion status update time-out value in 100-ms units.</p> <p>The default time-out value is 20 (2 s).</p>
	T17	5 to 250	<p><i>Initial alignment failure and link restart time</i></p> <p>Enter the initial alignment failure and link restart time-out value in 100-ms units.</p> <p>The default time-out value is 10 (1 s).</p>
	T18	5 to 60	<p><i>MTP restart STP TRA received timer</i></p> <p>Enter the <i>MTP restart STP TRA received timer</i> value in 1-s units.</p> <p>The default value is 40 (40 s).</p>
	T19	60 to 90	<p><i>MTP restart late TRA filter timer</i></p> <p>Enter the MTP restart late TRA filter timer value in 1-s units.</p> <p>The default value is 67 (67 s).</p>
	T20	5 to 120	<p><i>MTP restart overall timer</i></p> <p>Enter the restart overall timer value in 1-s units.</p> <p>The default value is 60 (60 s).</p>
	T21	5 to 120	<p><i>MTP restart adjacent node timer</i></p> <p>Enter the MTP restart adjacent node timer value in 1-s units.</p> <p>The default value is 63 (63 s).</p>
	T22	70 to 2200	<p><i>Local inhibit test timer</i></p> <p>Enter the local inhibit test time-out value in 1-s units.</p> <p>The default value is 180 (3 min).</p>
<p><b>Note:</b> The above timers are described in the appropriate sections of the relevant CCS7 signaling specifications.</p>			

**C7TIMER** (continued)**Field descriptions for conditional datafill (Sheet 5 of 5)**

Field	Subfield or refinement	Entry	Explanation and action
	T23	70 to 2200	<p><i>Remote inhibit test timer</i></p> <p>Enter the remote inhibit test time-out value in 1-s units.</p> <p>The default value is 180 (3 min).</p>
	T24	7 to 200	<p><i>Failed link craft referral timer</i></p> <p>Enter the failed link craft referral time-out value in 1-min units.</p> <p>The default value is 8 (8 min).</p>
<p><b>Note:</b> The above timers are described in the appropriate sections of the relevant CCS7 signaling specifications.</p>			

**NETSPEC = NTC704**

If the entry in field NETSPEC is NTC704, datafill refinements T1, T2, T3, T4, T5, T6, T7, T8, T10, T11, T12, T13, T14, T15, T16, T17, T18, T19, T21, T22, and T23 as described in the following table.

When a new entry is added in field NETSPEC, the default values from DEFDATA are automatically added. When the entry in field NETSPEC is changed, the default values from DEFDATA are not automatically entered.

The value for each timer must be separated from the next by a single space.

**CAUTION****Nodal timers are automatically updated for all non-ANSI704 networks**

Timers T18 and T20 are nodal. Each nodal timer is to be datafilled the same in all non-ANSI704 networks. When one of these nodal timers is changed in one non-ANSI704 network, the following warning message is issued indicating it has been changed for all non-ANSI704 networks.

\*\*\*WARNING\*\*\*

Nodal timers must be the same in all tuples for a network  
All other tuples for this network type will be modified

**C7TIMER** (continued)**Field descriptions for conditional datafill (Sheet 1 of 4)**

<b>Field</b>	<b>Subfield or refinement</b>	<b>Entry</b>	<b>Explanation and action</b>
	T1	5 to 12	<p><i>Mis-sequence changeover timer</i></p> <p>Enter the mis-sequence changeover time-out value in 100-ms units.</p> <p>The default time-out value is 10 (1 s).</p>
	T2	7 to 20	<p><i>Changeover acknowledgement timer</i></p> <p>Enter the changeover acknowledgement time-out value in 100-ms units.</p> <p>The default time-out value is 10 (1 s).</p>
	T3	5 to 12	<p><i>Mis-sequence changeback timer</i></p> <p>Enter the mis-sequence changeback time-out value in 100-ms units.</p> <p>The default time-out value is 10 (1 s).</p>
	T4	5 to 12	<p><i>Changeback acknowledgement timer (first attempt)</i></p> <p>Enter the changeback acknowledgement time-out value (first attempt) in 100-ms units.</p> <p>The default time-out value is 10 (1 s).</p>
	T5	5 to 12	<p><i>Changeback acknowledgement timer (second attempt)</i></p> <p>Enter the changeback acknowledgement time-out value (second attempt) in 100-ms units.</p> <p>The default time-out value is 10 (1 s).</p>
	T6	5 to 12	<p><i>Controlled rerouting timer</i></p> <p>Enter the controlled rerouting time-out value in 100-ms units.</p> <p>The default time-out value is 10 (1 s).</p>
<p><b>Note:</b> The above timers are described in the appropriate sections of the relevant CCS7 signaling specifications.</p>			

**C7TIMER** (continued)

## Field descriptions for conditional datafill (Sheet 2 of 4)

Field	Subfield or refinement	Entry	Explanation and action
	T7	10 to 20	<p><i>Signaling data link connection acknowledgement timer</i></p> <p>Enter the signaling data link connection acknowledgement time-out value in 100-ms units.</p> <p>The default time-out value is 15 (1.5 s).</p>
	T8	8 to 12	<p><i>Transfer prohibited timer</i></p> <p>Enter the transfer prohibited time-out value in 100-ms units.</p> <p>The default time-out value is 10 (1 s).</p>
	T10	30 to 60	<p><i>Signaling routeset test message timer</i></p> <p>Enter the signaling routeset test message time-out value in 1-s units.</p> <p>The default time-out value is 30 (30 s).</p> <p><b>Note:</b> The default time-out value must be increased to 60 (60 s) if more than 511 routesets are enabled with software optionality control (SOC).</p>
	T11	30 to 90	<p><i>Transfer restricted timer</i></p> <p>Enter the transfer restricted time-out value in 1-s units.</p> <p>The default time-out value is 69 (69 s).</p>
	T12	8 to 15	<p><i>Uninhibit acknowledgement timer</i></p> <p>Enter the uninhibit acknowledge time-out value in 100-ms units.</p> <p>The default time-out value is 10 (1 s).</p>
<p><b>Note:</b> The above timers are described in the appropriate sections of the relevant CCS7 signaling specifications.</p>			

**C7TIMER** (continued)

## Field descriptions for conditional datafill (Sheet 3 of 4)

Field	Subfield or refinement	Entry	Explanation and action
	T13	8 to 15	<p><i>Forced uninhibit timer</i></p> <p>Enter the forced uninhibit time-out value in 100-ms units.</p> <p>The default time-out value is 10 (1 s).</p>
	T14	2 or 3	<p><i>Inhibit acknowledgement message timer</i></p> <p>Enter the inhibit acknowledgement message time-out value in 1-s units.</p> <p>The default value is 3 (3 s).</p>
	T15	2 or 3	<p><i>Repeat routeset congestion test timer</i></p> <p>Enter the repeat routeset congestion test time-out value in 1-s units.</p> <p>The default time-out value is 2 (2 s).</p>
	T16	14 to 20	<p><i>Routeset congestion status update timer</i></p> <p>Enter the routeset congestion status update time-out value in 100-ms units.</p> <p>The default time-out value is 20 (2 s).</p>
	T17	8 to 15	<p><i>Initial alignment failure and link restart timer</i></p> <p>Enter the initial alignment failure and link restart time-out value in 100-ms units.</p> <p>The default time-out value is 10 (1 s).</p>
	T18	5 to 60	<p><i>Restart STP TRA received timer</i></p> <p>Enter the STP TRA receiver timer value in 1s units.</p> <p>The default time-out value is 40 (40 s).</p>
	T19	60 to 90	<p><i>Restart Late TRA filter timer</i></p> <p>Enter the TRA filter timer value in 1s units.</p> <p>The default time-out value is 67 (67 s).</p>
<p><b>Note:</b> The above timers are described in the appropriate sections of the relevant CCS7 signaling specifications.</p>			

**C7TIMER** (continued)**Field descriptions for conditional datafill (Sheet 4 of 4)**

<b>Field</b>	<b>Subfield or refinement</b>	<b>Entry</b>	<b>Explanation and action</b>
	T20	5 to 120	<i>Restart overall timer</i> Enter the overall timer value in 1s units. The default time-out value is 59 (59 s).
	T21	5 to 120	<i>Restart adjacent node timer</i> Enter the adjacent node timer value in 1s units. The default time-out value is 63 (63 s).
	T22	180 to 360	<i>Local inhibit test timer</i> Enter the local inhibit test time-out value in 1-s units. The default value is 180 (3 min).
	T23	180 to 360	<i>Remote inhibit test timer</i> Enter the remote inhibit test time-out value in 1-s units. The default value is 180 (3 min).
<b>Note:</b> The above timers are described in the appropriate sections of the relevant CCS7 signaling specifications.			

**NETSPEC = JPN704**

If the entry in field NETSPEC is JPN704, datafill refinements T1, T2, T3, T4, T6, T10, T16, T17, T18, T19, T20 and T21 as described in the following table.

When a new entry is added in field NETSPEC, the default values from DEFDATA are automatically added. When the entry in field NETSPEC is changed, the default values from DEFDATA are not automatically entered.



**C7TIMER** (continued)

The value for each timer must be separated from the next by a single space.

**CAUTION****Nodal timers are automatically updated for all non-ANSI704 networks**

Timers T18 and T20 are nodal. Each nodal timer is to be datafilled the same in all non-ANSI704 networks. When one of these nodal timers is changed in one non-ANSI704 network, the following warning message is issued indicating it has been changed for all non-ANSI704 networks.

\*\*\*WARNING\*\*\*

Nodal timers must be the same in all tuples for a network  
All other tuples for this network type will be modified

**Field descriptions for conditional datafill (Sheet 1 of 3)**

Field	Subfield or refinement	Entry	Explanation and action
	T1	5 to 250	<i>Mis-sequence changeover timer</i> Enter the mis-sequence changeover time-out value in 100-ms units. The default time-out value is 10 (1 s).
	T2	5 to 250	<i>Changeover acknowledgement timer</i> Enter the changeover acknowledgement time-out value in 100-ms units. The default time-out value is 10 (1 s).
	T3	5 to 250	<i>Mis-sequence changeback timer</i> Enter the mis-sequence changeback time-out value in 100-ms units. The default time-out value is 10 (1 s).
<b>Note:</b> The above timers are described in the appropriate sections of the relevant CCS7 signaling specifications.			

**C7TIMER** (continued)**Field descriptions for conditional datafill (Sheet 2 of 3)**

Field	Subfield or refinement	Entry	Explanation and action
	T4	5 to 250	<p><i>Changeback acknowledgement timer (first attempt)</i></p> <p>Enter the changeback acknowledgement time-out value (first attempt) in 100-ms units.</p> <p>The default time-out value is 10 (1 s).</p>
	T6	5 to 250	<p><i>Controlled rerouting timer</i></p> <p>Enter the controlled rerouting time-out value in 100-ms units.</p> <p>The default time-out value is 10 (1 s).</p>
	T10	20 to 750	<p><i>Signaling routeset test message timer</i></p> <p>Enter the signaling routeset test message time-out value in 1-s units.</p> <p>The default time-out value is 30 (30 s).</p> <p><b>Note:</b> The default time-out value must be increased to 60 (60 s) if more than 511 routesets are enabled with software optionality control (SOC).</p>
	T16	1 to 100	<p><i>Transfer controlled congestion timer</i></p> <p>Enter the transfer controlled (TFC) and link congestion time-out value in 1-s units.</p> <p>The default time-out value is 90 (90 s).</p>
	T17	5 to 250	<p><i>Initial alignment failure and link restart timer</i></p> <p>Enter the initial alignment failure and link restart time-out value in 100-ms units.</p> <p>The default time-out value is 10 (1 s).</p>
	T18	5 to 60	<p><i>Restart STP TRA received timer</i></p> <p>Enter the STP TRA receiver timer value in 1s units.</p> <p>The default time-out value is 40 (40 s).</p>
<p><b>Note:</b> The above timers are described in the appropriate sections of the relevant CCS7 signaling specifications.</p>			

**C7TIMER** (continued)**Field descriptions for conditional datafill (Sheet 3 of 3)**

Field	Subfield or refinement	Entry	Explanation and action
	T19	60 to 90	<i>Restart Late TRA filter timer</i> Enter the TRA filter timer value in 1s units. The default time-out value is 67 (67 s).
	T20	5 to 120	<i>Restart overall timer</i> Enter the overall timer value in 1s units. The default time-out value is 59 (59 s).
	T21	5 to 120	<i>Restart adjacent node timer</i> Enter the adjacent node timer value in 1s units. The default time-out value is 63 (63 s).
<b>Note:</b> The above timers are described in the appropriate sections of the relevant CCS7 signaling specifications.			

**NETSPEC = TTC704**

If the entry in field NETSPEC is TTC704, datafill refinements T2, T4, T18, T19, T20, and T21 as described in the following table.

When a new entry is added in field NETSPEC, the default values from DEFDATA are automatically added. When the entry in field NETSPEC is changed, the default values from DEFDATA are not automatically entered.

**C7TIMER** (continued)

The value for each timer must be separated from the next by a single space.

**CAUTION****Nodal timers are automatically updated for all non-ANSI704 networks**

Timers T18 and T20 are nodal. Each nodal timer is to be datafilled the same in all non-ANSI704 networks. When one of these nodal timers is changed in one non-ANSI704 network, the following warning message is issued indicating it has been changed for all non-ANSI704 networks.

\*\*\*WARNING\*\*\*

Nodal timers must be the same in all tuples for a network  
All other tuples for this network type will be modified

**Field descriptions for conditional datafill (Sheet 1 of 2)**

Field	Subfield or refinement	Entry	Explanation and action
	T2	5 to 250	<p><i>Changeover acknowledgement timer</i></p> <p>Enter the changeover acknowledgement time-out value in 100-ms units.</p> <p>Any entry outside the range indicated for this field is invalid.</p> <p>The default time-out value is 10 (1 s).</p>
	T4	5 to 250	<p><i>Changeback acknowledgement timer (first attempt)</i></p> <p>Enter the changeback acknowledgement time-out value (first attempt) in 100-ms units.</p> <p>Any entry outside the range indicated for this field is invalid.</p> <p>The default value is 10 (1 s).</p>
<p><b>Note:</b> The above timers are described in the appropriate sections of the relevant CCS7 signaling specifications.</p>			

**C7TIMER** (continued)

## Field descriptions for conditional datafill (Sheet 2 of 2)

Field	Subfield or refinement	Entry	Explanation and action
	T18	5 to 60	<i>MTP restart STP TRA received timer</i> Enter the signaling links available and TRA received time-out value in 1-s units. The default value is 40 (40 s).
	T19	60 to 90	<i>MTP restart late TRA filter timer</i> Enter the late TRA filter time-out value in 1-s units The default value is 67 (67 s).
	T20	5 to 120	<i>MTP restart overall timer</i> Enter the MTP restart time-out value in 1-s units. The default value is 59 (59 s).
	T21	5 to 120	<i>MTP restart adjacent node timer</i> Enter the TRA message from the adjacent node time-out value in 1-s units. The default value is 63 (63 s).
<b>Note:</b> The above timers are described in the appropriate sections of the relevant CCS7 signaling specifications.			

**NETSPEC = ANSI707**

If the entry in field NETSPEC is ANSI707, datafill refinements T1 and T3 as described in the following table.

When a new entry is added in field NETSPEC, the default values from DEFDATA are automatically added. When the entry in field NETSPEC is changed, the default values from DEFDATA are not automatically entered.

**C7TIMER** (continued)

The value for each timer must be separated from the next by a single space.

**Field descriptions for conditional datafill**

Field	Subfield or refinement	Entry	Explanation and action
	T1	5 to 750	<p><i>Signaling link test acknowledgement timer</i></p> <p>Enter the signaling link test acknowledgement time-out value in 100-ms units.</p> <p>Any entry outside the range indicated for this field is invalid.</p> <p>The default value is 30 (3 s).</p>
	T3	30 to 750	<p><i>Signaling link test interval</i></p> <p>Enter the signaling link test interval in 1-s units.</p> <p>The default value is 60 (60 s).</p>
<p><b>Note:</b> The above timers are described in the appropriate sections of the relevant CCS7 signaling specifications.</p>			

**NETSPEC = CCITT707**

If the entry in field NETSPEC is CCITT707, datafill refinements T1 and T3 as described in the following table.

When a new entry is added in field NETSPEC, the default values from DEFDATA are automatically added. When the entry in field NETSPEC is changed, the default values from DEFDATA are not automatically entered.

**C7TIMER** (continued)

The value for each timer must be separated from the next by a single space.

**Field descriptions for conditional datafill**

Field	Subfield or refinement	Entry	Explanation and action
	T1	5 to 750	<p><i>Signaling link test acknowledgement timer</i></p> <p>Enter the signaling link test acknowledgement time-out value in 100-ms units.</p> <p>Any entry outside the range indicated for this field is invalid.</p> <p>The default value is 120 (12 s).</p>
	T3	30 to 750	<p><i>Signaling link test interval</i></p> <p>Enter the signaling link test interval in 1-s units.</p> <p>The default value is 90 (90 s).</p>
<p><b>Note:</b> The above timers are described in the appropriate sections of the relevant CCS7 signaling specifications.</p>			

**NETSPEC = NTC707**

If the entry in field NETSPEC is NTC707, datafill refinements T1 and T2 as described in the following table.

When a new entry is added in field NETSPEC, the default values from DEFDATA are automatically added. When the entry in field NETSPEC is changed, the default values from DEFDATA are not automatically entered.

**C7TIMER** (continued)

The value for each timer must be separated from the next by a single space.

**Field descriptions for conditional datafill**

Field	Subfield or refinement	Entry	Explanation and action
	T1	40 to 120	<p><i>Signaling link test acknowledgement timer</i></p> <p>Enter the signaling link test acknowledgement time-out value in 100-ms units.</p> <p>Any entry outside the range indicated for this field is invalid.</p> <p>The default value is 40 (4 s).</p>
	T2	30 to 90	<p><i>Signaling link test interval timer</i></p> <p>Enter the signaling link interval time-out value in 1-s units.</p> <p>The default value is 60 (60 s).</p>
<p><b>Note:</b> The above timers are described in the appropriate sections of the relevant CCS7 signaling specifications.</p>			

**NETSPEC = JPN707**

If the entry in field NETSPEC is JPN707, datafill refinement T10 as described in the following table.

When a new entry is added in field NETSPEC, the default values from DEFDATA are automatically added. When the entry in field NETSPEC is changed, the default values from DEFDATA are not automatically entered.

**Field descriptions for conditional datafill**

Field	Subfield or refinement	Entry	Explanation and action
	T10	30 to 100	<p><i>Signaling route test timer</i></p> <p>Enter the signaling route test time-out value in 100-ms units.</p> <p>The default time-out value is 100 (10 s).</p>
<p><b>Note:</b> The above timer is described in the appropriate section of the relevant CCS7 signaling specifications.</p>			



**C7TIMER** (continued)**NETSPEC = TTC707**

If the entry in field NETSPEC is TTC707, datafill refinement T10 as described in the following table.

When a new entry is added in field NETSPEC, the default values from DEFDATA are automatically added. When the entry in field NETSPEC is changed, the default values from DEFDATA are not automatically entered.

**Field descriptions for conditional datafill**

Field	Subfield or refinement	Entry	Explanation and action
	T10	30 to 100	<p><i>Signaling link test acknowledgement timer</i></p> <p>Enter the signaling link test acknowledgement time-out value in 100-ms units.</p> <p>The default time-out value is 100 (10 s).</p>
<p><b>Note:</b> The above timer is described in the appropriate section of the relevant CCS7 signaling specifications.</p>			

**NETSPEC = ANSISAAL**

If the entry in field NETSPEC is ANSISAAL, datafill the refinements in the following table.

**Field descriptions for conditional datafill (Sheet 1 of 4)**

Field	Subfield or refinement	Entry	Explanation and action
	SAALT1	1 to 15	<p><i>SAAL T1</i></p> <p>Enter the SSCF time (in units of 1 s) between the link release and the next re-establish action during alignment of the link.</p> <p>The default SAALT1 timer value is 5 (5 s).</p>
	SAALT2	15 to 180	<p><i>SAAL T2</i></p> <p>Enter the total time (in units of 1 s) the SSCF attempts to realign the link.</p> <p>The default SAALT2 timer value is 120 (120 s).</p>

**C7TIMER** (continued)**Field descriptions for conditional datafill (Sheet 2 of 4)**

<b>Field</b>	<b>Subfield or refinement</b>	<b>Entry</b>	<b>Explanation and action</b>
	SAALT3	72 to 2300	<p><i>SAAL T3</i></p> <p>Enter the SSCF time between proving PDUs in units of 0.1 ms.</p> <p>The default SAALT3 timer value is 90 (9 ms).</p>
	SAALTCC	1 to 20	<p><i>SAAL Timer Connection Controller</i></p> <p>Enter the Connection Control timer value in units of 100 ms.</p> <p>The default SAALTCC timer value is 2 (200 ms).</p>
	SAALKALV	25 to 500	<p><i>SAAL Keep Alive</i></p> <p>Enter the maximum time (in units of 1 ms) that SSCOP can remain in the transient phase.</p> <p>The default SAALKALV timer value is 100 (100 ms).</p>
	SAALNORS	5 to 20	<p><i>SAAL No Response</i></p> <p>Enter the maximum time interval during which at least one STAT PDU must be received. Enter the value in units of 100 ms</p> <p>The default SAALNORS timer value is 15 (1.5 s).</p>
	SAALPOLL	25 to 500	<p><i>SAAL Poll</i></p> <p>Enter the time (in units of 1 ms) between transmitting poll messages.</p> <p>The default SAALPOLL timer value is 100 (100 ms).</p> <p><b>Note:</b> Nortel recommends using the default value. If you use any other value, the optimal operation of the link can be affected.</p>

**C7TIMER** (continued)**Field descriptions for conditional datafill (Sheet 3 of 4)**

<b>Field</b>	<b>Subfield or refinement</b>	<b>Entry</b>	<b>Explanation and action</b>
	SAALIDLE	25 to 1000	<p><i>SAAL Idle</i></p> <p>Enter the maximum time (in units of 1 ms) that SSCOP can remain in the idle phase.</p> <p>The default SAALIDLE timer value is 100 (100 ms).</p>
	SAALSREC	1 to 180	<p><i>SAAL Recovery</i></p> <p>Enter the layer management timer (in units of 1 min) for repeat SSCOP recovery.</p> <p>The default SAALSREC timer value is 60 (60 min).</p>
	SAALNOCRD	10 to 60	<p><i>SAAL No Credit</i></p> <p>Enter the maximum time a 0 credit condition can exist before layer management fails the link. Enter the value in units of 100 ms.</p> <p>The default SAALNOCRD timer value is 15 (1.5 s).</p>
	SAALSUP	10 to 600	<p><i>SAAL Superblock</i></p> <p>Enter the layer management superblock size timer value (in units of 1 s).</p> <p>The default SAALSUP timer value is 120 (120 s).</p>
	SAALLOSS	5 to 100	<p><i>SAAL Loss</i></p> <p>Enter the layer management status loss limit timer value in units of 100 ms.</p> <p>The default SAALLOSS timer value is 13 (1.3 s).</p>

**C7TIMER** (continued)**Field descriptions for conditional datafill (Sheet 4 of 4)**

Field	Subfield or refinement	Entry	Explanation and action
	SAALTAU	25 to 500	<p><i>SSCF T3</i></p> <p>Enter the layer management error monitoring interval value (in units of 1 ms).</p> <p>The default SAALTAU timer value is 100 (100 ms).</p>
	SAALPROV	1 to 20	<p><i>SSCF Proving</i></p> <p>Enter the time (in units of 1 min) that layer management is to monitor the status of the link after proving and being placed into service.</p> <p>The default SAALPROV timer value is 10 (10 min).</p>

**Datafill example**

The following example shows sample datafill for table C7TIMER.

The example shows datafill for network type and specification reference (field NETSPEC) values of ANSI703 and ANSI704, and ANSISAAL.

**MAP display example for table C7TIMER**

TIMEKEY	TIMEDATA
Q703	0 ANSI703 130 118 118 6 23 12 30 100
Q704	0 ANSI704 10 10 10 10 10 10 15 10 30 69 10 10 3 2 20 10 60 8 90 90 10 10 10 32 13 3 5 62 32 120 660 240
SAAL	0 ANSISAAL 5 120 45 2 100 15 100 100 60 15 120 13 100 10

**Table history****TL14**

Added timers T33 and T34 for NETSPEC = ANSI704.

## **C7TIMER** (continued)

---

### **TL13**

Updated timers' default values for NETSPEC = CCITT703, CCITT704, and CCITT707.

### **TL11**

Removed the SAAL timers datafill restrictions. Added error messages.

### **TL10**

Changed default value for field SAALT3 to 90.

### **TL09**

Added timer T31 to specification reference (SPEC\_REF) Q704.

### **STP04.0**

Removed HLIU datafill restrictions.

### **TL07**

Added information on SAAL timers. These fields are visible but not datafillable.

Changed default value for ANSI704 timer T11 to 90 seconds.

### **TL05**

Added nine timers, T22 to T30, to the ANSI704 network type and specification.

### **STP03**

Added four timers, T18 to T21, to the CCITT704, NTC704, TTC704, JPN704 network types and specifications.

## **Supplementary Information**

### **Error messages**

If the value in table C7TIMER subfield SAALT3 or the value in table C7LKPARM subfield RPDU is too low, the following error message appears:

```
EXCESSIVE PROVING PDU RATE
The following parameter relationship has been violated for
one or more links using this tuple:
{100 000 / c7timer-saal-t3} * 1.2 <= c7ltparam-rpdu
100 000 is a unit conversion factor
1.2 provides a 20% safety margin
```

**C7TIMER** (end)

The error message includes an algebraic formula, in which:

- c7timer-saal-t3 indicates the value in table C7TIMER, parameter SAALT3.
- c7lkparm-rpdu indicates the value in table C7LKPARM, parameter RPDU.

To clear the error message increase one or both values. The following table indicates suggested values for each field.

If the value in table C7TIMER subfield SAALT2 is too low or if the values in table C7TIMER subfield SAALT3 and table C7LKPARM subfield SSCFN1 are too high, the following error message appears:

```
EXCESSIVE PROVING TIME
The following parameter relationship has been violated for
one or more links using this tuple:
{c7timer-saal-t3 * c7lkparm-sscfn1 * 1.2} / 10 000} <=
c7timer-saal-t2
10 000 is a unit conversion factor
1.2 provides a 20% safety margin
```

The error message includes an algebraic formula, in which:

- c7timer-saal-t3 indicates the value in table C7TIMER, parameter SAALT3.
- c7lkparm-sscfn1 indicates the value in table C7LKPARM, parameter SSCFN1.
- c7timer-saal-t2 indicates the value in table C7TIMER, parameter SAALT2.

To clear the error message do one or more of the following:

- increase the value in table C7TIMER subfield SAALT2
- decrease the value of table C7TIMER subfield SAALT3
- decrease the value of table C7LKPARM subfield SSCFN1

The following table indicates suggested values for each field.

## C7TRKMEM

---

### Table name

CCS7 Trunk Member Table

### Functional description

Signaling network identifiers (SNID), which consist of a network identifier, point code, and circuit identification code (CIC), are used by Common Channel Signaling 7 (CCS7) to reference specific circuits (trunks) within the CCS7 network.

Table C7TRKMEM is used by CCS7 to relate the CIC portion of the SNID to the common language location identifier (CLLI) and trunk member number.

CCS7 ISDN user part (ISUP) trunks and some United Kingdom versions of the user part trunks can be datafilled in this table.

Table C7TRKMEM is indexed at the operating company level by CLLI and MEMNAME (trunk member number). In addition to the table key, table C7TRKMEM contains a field that lists the CIC for the specified trunk. The network and point code portions of a trunk's SNID (identified by its routeset) are stored in table ISUPDEST.

### Datafill sequence and implications

The following tables must be datafilled before table C7TRKMEM.

- ISUPDEST
- TRKMEM

### Table size

58,000 tuples (default)

100,000 tuples

*Note:* To enable the above table size, the switch must be equipped with CCS7 external routers.

100,001 to 120,960 tuples

*Note:* To enable the above tuple range, the switch must be a stand-alone SSP that is equipped with external routing, 32-megabyte LIU7s. The external routing must be on, and the value of the Network\_Active office parameter must be set to EXTERNET.

**C7TRKMEM** (continued)

For an INode office, you cannot datafill more than 20 k tuples if table C7GTT has more than 25 k tuples.

For more information, refer to the appropriate engineering guidelines.

**Datafill**

The following table lists datafill for table C7TRKMEM.

**Field descriptions**

Field	Subfield or refinement	Entry	Explanation and action
MEMKEY		see subfields	<i>Member key</i> This field consists of subfields CLLI and MEMNAME.
	CLLI	alphanumeric (1 to 16 characters)	<i>Common language location identifier</i> Enter the code assigned in table CLLI to the trunk group of which the trunk is a member.
	MEMNAME	numeric (0 to 9999)	<i>Trunk member number</i> Enter the member number assigned to the trunk. This number is assigned in field EXTRKNM of table TRKMEM.
CIC		numeric (0 to 16383)	<i>CCS7 circuit identification code</i> Enter a digit to represent the CIC of the trunk circuit. Allocating CICs contiguously (top down, bottom up, or both) makes the most efficient use of data store.  For CCITT trunks, the valid range is limited to 0 to 4095.

**Datafill example**

The following example shows sample initial datafill for table C7TRKMEM. The example shows the assignment of CICs to the members of trunk groups ISUPINC, ISUPOTG, and ISUP2W.



**C7TRKMEM** (continued)**MAP display example for table C7TRKMEM**

MEMKEY	CIC
ISUPINC 0	100
ISUPINC 1	101
ISUPINC 2	102
ISUPOTG 0	100
ISUPOTG 1	101
ISUPOTG 2	102
ISUP2W 0	200
ISUP2W 1	201
ISUP2W 2	202

**Table history****NA013**

Added new table size range of 100,001 to 120,960 tuples for Succession Network VToA (Voice Trunking Over ATM) application (59012825).

**SHR12**

Updated table size limits and added an error message (feature 59009405).

**CSP08**

Added STP SOC and external routing effect on table size.

**Supplementary information**

This section provides additional information related to table C7TRKMEM.

**Data entry error messages**

If you try to add an entry that is associated with a subgroup for which no routeset has been defined in table ISUPDEST, the following error message is displayed:

```
A DESTINATION HAS NOT BEEN DEFINED FOR THIS MEMBER'S TRUNK
SUBGROUP - SEE TABLE xxxxDEST
```

CCS7 supports connections to a maximum of 256 CCS7 nodes (network and point code). If you try to datafill table C7TRKMEM with trunk CICs that are associated with more than the maximum number of nodes allowed, the following error message is displayed:

```
LIMIT ON POINT CODE CONNECTIONS EXCEEDED
```

---

**C7TRKMEM** (end)

---

If you try to datafill a trunk using the same CIC and associated routeset as an existing trunk, the following error message is displayed:

```
THE SNID SPECIFIED BY THE ROUTESET (FROM THE xxxxDEST table) AND  
THE CIC JUST ENTERED HAS ALREADY BEEN ALLOCATED
```

**Note:** While the cause of this error is often obvious, it can be obscured if the user has datafilled multiple ISUPDEST entries with the same routeset.

The range of CICs allowed in a CCITT network is smaller than the range allowed in an American National Standards Institute (ANSI) or NTC7 network (0 to 4095 rather than 0 to 16 383). If you are datafilling a CCITT trunk and have provided a CIC greater than 4095, the following error message is displayed:

```
INVALID CIRCUIT ID CODE FOR CCITT NETWORK
```

If the table control software is unable to establish a context in which to interpret the CIC just entered, this means that no associated entries exist in tables TRKMEM and TRKSGRP. In this case, an attempt to add an entry to table C7TRKMEM results in the display of the standard error message:

```
UNEXPECTED ERROR CONDITION
```

For an INode office, if table C7GTT has more than 25 k tuples, you cannot datafill more than 20 k tuples in table C7TRKMEM. If you try, the system displays the following error message:

```
Table C7TRKMEM is at the limit of 20 000 tuples. This limit is  
for offices functioning as INodes if Table C7GTT contains more  
than 25 000 tuples. Tuple NOT added.
```

---

## C7UPTMR

---

### Table name

CCS7 Signaling ISUP Timers Table

### Functional description

Table C7UPTMR contains call processing and maintenance timers. The timers are datafilled according to trunk subgroup.

Table TRKSGRP contains field TMRNAME, which is also the key to table C7UPTMR. The entry in field TMRNAME connects one or more trunk subgroups to one tuple in table C7UPTMR.

You use table C7UPTMR to datafill sets of timers. The timers are assigned according to the direction and protocol fields of table C7UPTMR.

**Note 1:** After changing timer values in C7UPTMR, you must reset the affected trunks for the changes to take effect.

**Note 2:** On SPMs the Backward Check Tone Timer (T24 Timer) is always fixed at the maximum value of 2 seconds (2000ms) and does not depend on the datafill in table C7UPTMR. See the specific signaling protocol sections, including CCITT250, Q767, TUP\_BLUE, and TUPPLUS, for further explanation of the Backward Check Tone Timer.

The following protocols can be datafilled in table C7UPTMR:

- AISUP is used for all versions of Australian ISDN user part (ISUP) in DMS-100 switches that include
  - Australian ISUP (AISUP)
  - Interconnect-ISUP (I-ISUP)
  - Malaysian ISUP (MISUP)
  - Philippines telephone user part (TUP) (PTUP)
- ATUP is used for the Australian telephone user part for DMS-100 and DMS-300 switches
- BTUP is used for the United Kingdom (UK) variant of national user part
- CCITT250 is used for CCITT ISUP on DMS-250 switches
- CTUP is used for Chinese telephone user part for MMP and CS2KC switches
- IBNISUP is used for Integrated Business Network 7 (IBN7), also known as American National Standards Institute 7 (ANSI7), call processing, and IBN7-to-IBN7 for global networking (GN) calls

**C7UPTMR** (continued)

- JPNISUP is used for Japan Public Network 7 (JPN7) trunks in DMS-100 switches
- MBTUP is used for interworking within operating company-specific networks
- NCCI is used if the operating company-specific CCITT7 protocols (NCCI7) are packaged on the DMS-100 switch
- Q764 is used for American National Standards Institute (ANSI) ISUP
- Q767 is used for ITU-T/ETSI ISUP in DMS-100 switches
- RBTUP is used for any Redbook TUP protocol
- TUP\_BLUE is used by the DMS-300 switch for interworking with signaling 7 protocols BTUP and TUPPLUS (TUP+)
- TUPPLUS is used for interworking BTUP with telephone user part plus (TUP+) (or any other signaling 7 protocol)

*Note:* Datafill in table C7UPTMR that references a particular protocol is ineffective unless the functionality that supports the protocol is installed. See the following table for a list of required feature packages for each protocol.

**Functionalities supporting protocols**

Protocol	Functionality
AISUP	Australian ISUP for DMS-100
ATUP	Australian TUP for DMS-100 DMS-300 Australian ISUP
BTUP	BTUP on DMS-300
CCITT250	DMS-300 International CCITT ISUP (Q.767) & ETSI ISUP
CTUP	International China TUP for MMP and CS2KC
IBNISUP	DMS-300 ANSI7+ Services
JPNISUP	JPN ISUP Trunk Signaling
MBTUP	BTUP on DMS-300
NCCI	DMS-100 NCCI#7 to ANSI7+ Interworking CCITT #7 and NCCI #7 for DMS-100

**C7UPTMR** (continued)**Functionalities supporting protocols**

Protocol	Functionality
Q764	DMS-300 ANSI7+ Services International ANSI ISUP
Q767	ETSI ISUP, including all versions and national variants currently supported
RBTUP	Standard Redbook TUP, SSUTR2 (French TUP), and Brazilian TUP
TUP_BLUE	DMS-300 ANSI7+Blue Book TUP I/W TUP Blue Book on DMS-300
TUPPLUS	TUP(+) on DMS-300
general	ATUP-ANSI ISUP/AISUP Interworking

Three directions can be datafilled:

- 2W (two-way)
- IC (incoming)
- OG (outgoing)

The sets of timers are as follows:

- AISUP incoming, outgoing, and two-way timers
- ATUP incoming, outgoing, and two-way timers
- BTUP incoming, outgoing, and two-way timers
- CCITT incoming, outgoing, and two-way timers
- CTUP incoming, outgoing, and two-way timers
- IBNISUP incoming, outgoing, and two-way timers
- JPNISUP incoming, outgoing, and two-way timers
- MBTUP incoming, outgoing, and two-way timers
- NCCI incoming, outgoing, and two-way timers
- Q764 incoming, outgoing, and two-way timers
- Q767 two-way timers
- Q767 incoming timers (for SSUTR2 only)
- Q767 outgoing timers (for SSUTR2 only)

## **C7UPTMR** (continued)

---

- RBTUP incoming, outgoing, and two-way timers
- TUP\_BLUE incoming, outgoing, and two-way timers
- TUPPLUS incoming, outgoing, and two-way timers

Any set of timers can be datafilled more than once. For example, table TRKSGRP can contain two tuples that require incoming CCITT timers, but require different values for the timers. The entry in field TMRNAME (timer name) is different for each tuple in table C7UPTMR.

The direction, protocol, and timer name (TMRNAME) values of table TRKSGRP must also exist in a tuple of table C7UPTMR. If this requirement is not met, the entry in table TRKSGRP is not valid.

### **Q33 timer on DMS-300 gateway**

If the Q33 option is present in the load, field OPTION is always visible, but is present only on selected incoming and two-way trunks.

The Q33 option cannot be deleted from table C7UPTMR if it is referenced by a tuple in table TRKSGRP that is datafilled with the Q33SUP option. The Q33SUP option must first be deleted from table TRKSGRP and then the Q33 option can be deleted from table C7UPTMR.

### **ANSI ISUP on DMS-300 gateway**

The DMS-300 gateway switch can support ANSI7 Signaling ISUP trunks and interwork calls on these trunks with CCITT No. 7 Signaling (N7) ISUP trunk calls.

ANSI trunks use ANSI timer values that are defined in table C7UPTMR. An ANSI timer must be datafilled in table C7UPTMR.

## **Datafill sequence and implications**

The following tables must be datafilled before table C7UPTMR:

- TRKGRP
- TRKMEM
- TRKBCHNL
- all message transfer part (MTP) tables
- ISUPDEST
- C7TRKMEM

**C7UPTMR** (continued)

The following tables must be datafilled after table C7UPTMR:

- TRKSGRP

**Table size**

0 to 31 tuples

The maximum number of tuples that can be datafilled is 31, with one tuple assigned the value NIL.

**Datafill**

The following table lists datafill for table C7UPTMR.

**Field descriptions**

Field	Subfield	Entry	Explanation and action
TMRKEY		alphanumeric (1 to 16 characters)	<i>Timer key</i> Enter a name that is the key to the table and is datafilled in table TRKSGRP.  For global trunks (GTRK), enter a name that is the key to the table and is datafilled in table TRKSIGPF.
C7UPDIR		2W, IC, or OG	<i>C7 trunk direction</i> If the trunk direction is two-way (or both ways), enter 2W. If the trunk direction is incoming, enter IC. If the trunk direction is outgoing, enter OG.

**C7UPTMR** (continued)**Field descriptions**

Field	Subfield	Entry	Explanation and action
TMRS		see subfield	<i>Timers</i>  This field contains subfield PROT. Datafill for subfield PROT depends on the signaling protocol.
	PROT	AISUP, ATUP, BTUP, CCITT250, CTUP, IBNISUP, JPNISUP, MBTUP, NCCI, Q764, Q767, RBTUP, TUP_BLUE, or TUPPLUS	Enter the required protocol, and enter the remaining datafill for subfield PROT as described in this document.

**Signaling protocol CTUP: Chinese Telephone User Part**

Signaling protocol CTUP is used for the Chinese telephone user part for DMS-100MMP and CS2KC.

**Datafill**

The following table lists the datafill for table C7UPTMR for signaling protocol CTUP.

**Field descriptions**

Field	Subfield	Entry	Explanation and action
	PROT	See subfields	<i>Protocol</i>  If the entry in field C7UPDIR is 2W, this subfield consists of subfield BWPROT described in section "C7UPDIR = 2W".  If the entry in field C7UPDIR is IC, this subfield consists of subfield ICPROT described in section "C7UPDIR = IC".  If the entry in field C7UPDIR is OG, this subfield consists of subfield OGPROT described in section "C7UPDIR = OG".



**C7UPTMR** (continued)**C7UPDIR=2W**

If the entry in subfield C7UPDIR is 2W, datafill subfield BWPROT and refinements as described in the following table, then datafill field OPTIONS.

**Field descriptions**

Field	Subfield	Entry	Explanation and action
	BWPROT	CTUP	<i>Two-way protocol</i>  Enter CTUP to indicate that the timers are CTUP timers
	ACMBSM	1 to 45	<i>Address complete or backward setup signal timer</i>  Times from the sending of last forward address message (IAM / IAI / SAM / SAO) to the receipt of an ACM or BSM. It is reset at the sending of each forward address message.  On timeout, the call is taken down.
	UBMCLF	4 to 15	<i>Unsuccessful backward message to clear forward signal timer</i>  Times from the sending of a UBM to the receipt of a CLF for the incoming circuit.  On timeout, a CFL is sent, and the UBMCLF timer is restarted.
	UBMCLF2	60 to 120	<i>Unsuccessful backward message to clear forward secondary signal timer</i>  This timer is started in parallel with the UBMCLF timer. It times from the sending of a UBM to  the receipt of a CLF for the incoming circuit. On timeout, the UBMCLF timer is stopped, the RSC is sent.
	CFLCLF	4 to 15	<i>Call failure to clear forward signal timer</i>  Times from the sending of a CFL to the receipt of a CLF for the incoming circuit.  On timeout a CFL is sent and the CFLCLF timer is restarted. Since CFLCLF timer is used with CFLCLF2 timer, CFLCLF timer is stopped when CFLCLF2 timer expires.

**C7UPTMR** (continued)**Field descriptions**

<b>Field</b>	<b>Subfield</b>	<b>Entry</b>	<b>Explanation and action</b>
	CFLCLF2	60 to 120	<p><i>Call failure to clear forward secondary signal timer</i></p> <p>This timer is started in parallel with the CFLCLF timer. It times from the sending of a CFL to the receipt of a CLF for the incoming circuit.</p> <p>On timeout, the CFLCLF timer is stopped, the RSC is sent, and the RSCRESP timer is started.</p>
	CLFRLG	4 to 15	<p><i>Clear forward to release guard signal timer</i></p> <p>Times from the sending of a CLF to the receipt of a RLG.</p> <p>On timeout, a CLF is sent and the CLFRLG timer is restarted. The CLFRLG timer is used in conjunction with CLFRLG2 timer. Thus CLFRLG timer is stopped when CLFRLG2 expires.</p>
	CLFRLG2	60 to 120	<p><i>Clear forward to release guard secondary signal timer</i></p> <p>This timer is started in parallel with the CLFRLG timer. It times from the sending of a CLF to the receipt of a RLG.</p> <p>On timeout, the CLFRLG timer is stopped, the RSC is sent, and the RSCRESP timer is started</p>
	RSCRESP	4 to 15	<p><i>Reset circuit response timer</i></p> <p>Times from the sending of a RSC to the receipt of an acknowledgement for this message. The particular acknowledgement received will depend on initial conditions. This ensures circuits are reset to idle after a fault has occurred.</p> <p>On timeout, the RSC is repeated and the RSCRESP timer is restarted. Since RSCRESP timer is used with secondary timer RSCRESP2, RSCRESP is stopped when RSCRESP2 expires.</p>

**C7UPTMR** (continued)**Field descriptions**

<b>Field</b>	<b>Subfield</b>	<b>Entry</b>	<b>Explanation and action</b>
	RSCRESP2	60 to 120	<p><i>Reset circuit response secondary timer</i></p> <p>Times from the sending of a RSC to the receipt of an acknowledgement for this message. The particular acknowledgement received will depend on initial conditions.</p> <p>On timeout, the RSCRESP timer is stopped, the RSC is sent and the RSCRESP2 timer is restarted.</p>
	ANSWER	50 to 70	<p><i>Answer timer for local calls</i></p> <p>Times from the reception of an ACM message to the reception of an ANC/ANN message for local calls.</p> <p>On timeout, the call is taken down. A CFL is used to take down the call in the backward direction when the originating trunk is a CTUP trunk.</p>
	ANSNATL	80 to 100	<p><i>Answer timer for national calls</i></p> <p>The functionality is the same for ANSWER timer, the only difference is the range which is 80-100 seconds. This timer is used instead of ANSWER timer when the nature of address signal in the message indicators of a received or sent IAM or IAI message is equal to 10 (national).</p>
	ANSINTL	100 to 140	<p><i>Answer timer for international calls</i></p> <p>The functionality is the same for ANSWER timer, the only difference is the range which is 100-140 seconds. This timer is used instead of ANSWER timer when the nature of address signal in the message indicators of a received or sent IAM or IAI message is equal to 11 (international).</p>

**C7UPTMR** (continued)**Field descriptions**

<b>Field</b>	<b>Subfield</b>	<b>Entry</b>	<b>Explanation and action</b>
	REANSWER	50 to 70	<p><i>Reanswer timer for local calls</i></p> <p>For incoming trunk, times from the sending of a CBK to the receipt of a CLF or RAN. On timeout, the call is taken down in the backward direction by sending a RSC.</p> <p>For the outgoing circuit it is used for waiting reanswer message. On timeout the call is taken down in the forward direction by sending a CLF.</p>
	REANSNATL	80 to 100	<p><i>Reanswer timer for national calls</i></p> <p>The functionality is the same as REANSWER timer above. This timer is used instead of REANSWER timer when the nature of address signal in the message indicators of a received or sent IAM or IAI message is equal to 10 (national).</p>
	REANSINTL	100 to 140	<p><i>Reanswer timer for international calls</i></p> <p>The functionality is the same as REANSWER timer above. This timer is used instead of REANSWER timer when the nature of address signal in the message indicators of a received or sent IAM or IAI message is equal to 11 (international).</p>
	IDGTBFR	4 to 21	<p><i>Interdigit timer before receipt of minimum number of digits</i></p> <p>Times from the receipt of an initial address message (IAM / IAI) or from each subsequent address message (SAM / SAO) before the minimum number of digits required for routing have been received (partial dialling).</p> <p>On timeout, the call is cleared down. The ADI is used for take down in the backward direction.</p>

**C7UPTMR** (continued)**Field descriptions**

Field	Subfield	Entry	Explanation and action
	IDGTAFT	4 to 21	<p><i>Interdigit timer after receipt of minimum number of digits</i></p> <p>Times from the receipt of an initial address message (IAM / IAI) or from each subsequent address message (SAM / SAO) after minimum number of digits required for routing have been received.</p> <p>Timeout indicates end of dialling; normal actions continue.</p>
OPTION		\$	<i>Timer options list. Enter \$.</i>

**C7UPDIR=IC**

If the entry in subfield C7UPDIR is IC, datafill subfield ICPROT and refinements as described in the following table, then datafill field OPTIONS.

**Field descriptions**

Field	Subfield	Entry	Explanation and action
	ICPROT	CTUP	<p><i>Incoming protocol</i></p> <p>Enter CTUP to indicate that the timers are CTUP timers</p>
	UBMCLF	4 to 15	<p><i>Unsuccessful backward message to clear forward signal timer</i></p> <p>Times from the sending of a UBM to the receipt of a CLF for the incoming circuit.</p> <p>On timeout, a CFL is sent, and the UBMCLF timer is restarted.</p>
	UBMCLF2	60 to120	<p><i>Unsuccessful backward message to clear forward secondary signal timer</i></p> <p>This timer is started in parallel with the UBMCLF timer. It times from the sending of a UBM to</p> <p>the receipt of a CLF for the incoming circuit. On timeout, the UBMCLF timer is stopped, the RSC is sent.</p>

**C7UPTMR** (continued)**Field descriptions**

<b>Field</b>	<b>Subfield</b>	<b>Entry</b>	<b>Explanation and action</b>
	CFLCLF	4 to 15	<p><i>Call failure to clear forward signal timer</i></p> <p>Times from the sending of a CFL to the receipt of a CLF for the incoming circuit.</p> <p>On timeout a CFL is sent and the CFLCLF timer is restarted. Since CFLCLF timer is used with CFLCLF2 timer, CFLCLF timer is stopped when CFLCLF2 timer expires.</p>
	CFLCLF2	60 to 120	<p><i>Call failure to clear forward secondary signal timer</i></p> <p>This timer is started in parallel with the CFLCLF timer. It times from the sending of a CFL to the receipt of a CLF for the incoming circuit.</p> <p>On timeout, the CFLCLF timer is stopped, the RSC is sent, and the RSCRESP timer is started.</p>
	RSCRESP	4 to 15	<p><i>Reset circuit response timer</i></p> <p>Times from the sending of a RSC to the receipt of an acknowledgement for this message. The particular acknowledgement received will depend on initial conditions. This ensures circuits are reset to idle after a fault has occurred.</p> <p>On timeout, the RSC is repeated and the RSCRESP timer is restarted. Since RSCRESP timer is used with secondary timer RSCRESP2, RSCRESP is stopped when RSCRESP2 expires.</p>
	RSCRESP2	60 to 120	<p><i>Reset circuit response secondary timer</i></p> <p>Times from the sending of a RSC to the receipt of an acknowledgement for this message. The particular acknowledgement received will depend on initial conditions.</p> <p>On timeout, the RSCRESP timer is stopped, the RSC is sent and the RSCRESP2 timer is restarted.</p>

**C7UPTMR** (continued)**Field descriptions**

<b>Field</b>	<b>Subfield</b>	<b>Entry</b>	<b>Explanation and action</b>
	REANSWER	50 to 70	<p><i>Reanswer timer for local calls</i></p> <p>Times from the sending of a CBK to the receipt of a CLF or RAN. On timeout, the call is taken down in the backward direction by sending a RSC.</p>
	REANSNATL	80 to 100	<p><i>Reanswer timer for national calls</i></p> <p>The functionality is the same as REANSWER timer above. This timer is used instead of REANSWER timer when the nature of address signal in the message indicators of a received or sent IAM or IAI message is equal to 10 (national).</p>
	REANSINTL	100 to 140	<p><i>Reanswer timer for international calls</i></p> <p>The functionality is the same as REANSWER timer above. This timer is used instead of REANSWER timer when the nature of address signal in the message indicators of a received or sent IAM or IAI message is equal to 11 (international).</p>
	IDGTBFR	4 to 21	<p><i>Interdigit timer before receipt of minimum number of digits</i></p> <p>Times from the receipt of an initial address message (IAM / IAI) or from each subsequent address message (SAM / SAO) before the minimum number of digits required for routing have been received (partial dialling).</p> <p>On timeout, the call is cleared down. The ADI is used for take down in the backward direction.</p>

**C7UPTMR** (continued)**Field descriptions**

Field	Subfield	Entry	Explanation and action
	IDGTAFT	4 to 21	<p><i>Interdigit timer after receipt of minimum number of digits</i></p> <p>Times from the receipt of an initial address message (IAM / IAI) or from each subsequent address message (SAM / SAO) after minimum number of digits required for routing have been received.</p> <p>Timeout indicates end of dialling; normal actions continue.</p>
OPTION		\$	<i>Timer options list. Enter \$.</i>

**C7UPDIR=OG**

If the entry in subfield C7UPDIR is OG, datafill subfield OGPROT and refinements as described in the following table, then datafill field OPTIONS described at the end of the following table.

**Field descriptions**

Field	Subfield	Entry	Explanation and action
	OGPROT	CTUP	<p><i>Outgoing protocol</i></p> <p>Enter CTUP to indicate that the timers are CTUP timers</p>
	ACMBSM	1 to 45	<p><i>Address complete or backward setup signal timer</i></p> <p>Times from the sending of last forward address message (IAM / IAI / SAM / SAO) to the receipt of an ACM or BSM. It is reset at the sending of each forward address message.</p> <p>On timeout, the call is taken down.</p>
	CLFRLG	4 to 15	<p><i>Clear forward to release guard signal timer</i></p> <p>Times from the sending of a CLF to the receipt of a RLG.</p> <p>On timeout, a CLF is sent and the CLFRLG timer is restarted. The CLFRLG timer is used in conjunction with CLFRLG2 timer. Thus CLFRLG timer is stopped when CLFRLG2 expires.</p>



**C7UPTMR** (continued)**Field descriptions**

<b>Field</b>	<b>Subfield</b>	<b>Entry</b>	<b>Explanation and action</b>
	CLFRLG2	60 to 120	<p><i>Clear forward to release guard secondary signal timer</i></p> <p>This timer is started in parallel with the CLFRLG timer. It times from the sending of a CLF to the receipt of a RLG.</p> <p>On timeout, the CLFRLG timer is stopped, the RSC is sent, and the RSCRESP timer is started</p>
	RSCRESP	4 to 15	<p><i>Reset circuit response timer</i></p> <p>Times from the sending of a RSC to the receipt of an acknowledgement for this message. The particular acknowledgement received will depend on initial conditions. This ensures circuits are reset to idle after a fault has occurred.</p> <p>On timeout, the RSC is repeated and the RSCRESP timer is restarted. Since RSCRESP timer is used with secondary timer RSCRESP2, RSCRESP is stopped when RSCRESP2 expires.</p>
	RSCRESP2	60 to 120	<p><i>Reset circuit response secondary timer</i></p> <p>Times from the sending of a RSC to the receipt of an acknowledgement for this message. The particular acknowledgement received will depend on initial conditions.</p> <p>On timeout, the RSCRESP timer is stopped, the RSC is sent and the RSCRESP2 timer is restarted.</p>
	ANSWER	50 to 70	<p><i>Answer timer for local calls</i></p> <p>Times from the reception of an ACM message to the reception of an ANC/ANN message for local calls.</p> <p>On timeout, the call is taken down. A CFL is used to take down the call in the backward direction when the originating trunk is a CTUP trunk.</p>

**C7UPTMR** (continued)**Field descriptions**

<b>Field</b>	<b>Subfield</b>	<b>Entry</b>	<b>Explanation and action</b>
	ANSNATL	80 to 100	<p><i>Answer timer for national calls</i></p> <p>The functionality is the same for ANSWER timer, the only difference is the range which is 80-100 seconds. This timer is used instead of ANSWER timer when the nature of address signal in the message indicators of a received or sent IAM or IAI message is equal to 10 (national).</p>
	ANSINTL	100 to 140	<p><i>Answer timer for international calls</i></p> <p>The functionality is the same for ANSWER timer, the only difference is the range which is 100-140 seconds. This timer is used instead of ANSWER timer when the nature of address signal in the message indicators of a received or sent IAM or IAI message is equal to 11 (international).</p>
	REANSWER	50 to 70	<p><i>Reanswer timer for local calls</i></p> <p>For incoming trunk, times from the sending of a CBK to the receipt of a CLF or RAN. On timeout, the call is taken down in the backward direction by sending a RSC.</p> <p>For the outgoing circuit it is used for waiting reanswer message. On timeout the call is taken down in the forward direction by sending a CLF.</p>
	REANSNATL	80 to 100	<p><i>Reanswer timer for national calls</i></p> <p>The functionality is the same as REANSWER timer above. This timer is used instead of REANSWER timer when the nature of address signal in the message indicators of a received or sent IAM or IAI message is equal to 10 (national).</p>

**C7UPTMR** (continued)**Field descriptions**

Field	Subfield	Entry	Explanation and action
	REANSINTL	100 to 140	<i>Reanswer timer for international calls</i>  The functionality is the same as REANSWER timer above. This timer is used instead of REANSWER timer when the nature of address signal in the message indicators of a received or sent IAM or IAI message is equal to 11 (international).
OPTION		\$	<i>Timer options list. Enter \$.</i>

**Datafill examples**

The figure that follows shows sample datafill for Q767 protocol for table C7UPTMR, with increased timer ranges after ISN06.

**MAP display example for table C7UPTMR**

```

TMRKEY C7UPDIR TMRS OPTIONS
-----
OGN7 OG Q767 15 180 326 900 90 20 180 10 900 10 900 1000
10 120 240 10 $
ICN7 IC Q767 15 180 326 900 90 15 5 15 10 900 10 900 10
900 10 900 10 900 10 900 10 120 240 10 20 4 $
2WN7 2W Q767 15 180 326 900 90 20 15 180 5 15 10 900 10
900 10 900 10 900 10 900 10 900 1000 10 120 240 10 15
20 4 10 $

```

The figure that follows shows sample datafill for protocol CTUP for table C7UPTMR

**C7UPTMR** (continued)**MAP display example for table C7UPTMR**

```
TMRKEY C7UPDIR TMRS OPTIONS
```

```

CTUP2WTMR IC CTUP 15 60 15 60 15 60 60 80 120 15 15 $
CTUP2WTMR OG CTUP 15 15 60 15 60 60 90 120 60 80 120 $
CTUP2WTMR 2W CTUP 15 15 60 15 60 15 60 15 60 60 90 120 60
80 120 15 15 $

```

**Table history****SN06 (DMS)**

Added support for Russian ISUP variant (feature A00000937) by increasing the maximum ranges of values for the following timers, within the BWPROT, ICPROT and OGPROT refinements for the Q767 protocol:

- NQ764T5, NQ764T13, NQ764T15, NQ764T17, NQ764T19, NQ764T21 and NQ764T23

The range in each case is now 1 to 900. These timers are described in detail in section “C7UPTMR signaling protocol Q767”.

Added CTUP to field PROT to specify the timer for CTUP trunk. Feature A89008212.

Included fixed 2 second Backward Check Tone Timer (T24 Timer) on SPMs for activity Q00733877.

Added note indicating that trunks must be reset to implement new timer values in C7UPTMR for activity Q00733616.

**MMP15**

Added timer T33 to CCITT refinement table added by feature AF7171.

**MMP13**

Added field VARIANT in protocol RBTUP.

**EUR010**

Added references to protocol Q767.

**APC008**

Added support to AISUP for I-ISUP, MISUP, and PTUP timers.

---

**C7UPTMR** (end)

---

**EUR008**

Added timers for RBTUP protocol.

**EUR006**

Added support for CCITT ISUP variants by increasing the maximum ranges of values for the following fields from 180 to 300:

- NQ764T5, NQ764T13, NQ764T15, NQ764T17, NQ764T19, NQ764T21 and NQ764T23

These timers and their ranges are described in *ITU Q.761 to Q.764*.

**GL02**

Added China telephone user part (CTUP) timers.

**APC004**

An optional minimum charge duration (MCD) timer was added to field OPTIONS for IC and 2W AISUP, ATUP, and Q764 protocols.

**BCS36**

The following changes were implemented:

- Added note to field PROT.
- Added entry Q33 to field OPTION for IC and 2W BTUP, CCITT250, TUP\_BLUE, and TUPPLUS protocols.
- Corrected ranges for field TUPT10.
- Removed fields Q118\_1 and Q118\_2 for protocol BTUP.
- Removed fields NQ764T35 and NQ764537 for protocol CCITT250.



---

## C7UPTMR signaling protocol AISUP

---

### Australian ISDN user part

AISUP is used for all versions of the Australian ISDN user part (AISUP) in DMS-100 switches which includes

- AISUP
- Interconnect-ISUP (I-ISUP)
- Malaysian ISUP (MISUP)
- Philippines telephone user part (PTUP)

### Datafill

The following table lists the datafill for table C7UPTMR signaling protocol AISUP.

#### Field descriptions

Field	Subfield or refinement	Entry	Explanation and action
	PROT	see subfields	<p><i>Protocol</i>If the entry in field C7UPDIR is 2W, this subfield consists of subfield BWPROT described in Section "C7UPDIR = 2W".</p> <p>If the entry in field C7UPDIR is IC, this subfield consists of subfield ICPROT described in Section "C7UPDIR = IC".</p> <p>If the entry in field C7UPDIR is OG, this subfield consists of subfield OGPROT described in Section "C7UPDIR = OG".</p>

---

**C7UPTMR signaling protocol AISUP** (continued)

---

**C7UPDIR = 2W**

If the entry in subfield C7UPDIR is 2W, datafill subfield BWPROT and refinements as described in the following table, then datafill field OPTIONS.

**Field descriptions for conditional datafill (Sheet 1 of 11)**

Field	Subfield or refinement	Entry	Explanation and action
	BWPROT	AISUP	<i>Two-way protocol</i> Enter AISUP to specify that the timers are used for the Australian ISUP in DMS-100 switches.
	RELRLC	4 to 60	<i>Release to release complete timer</i> Enter the time, in seconds, to wait for a release complete (RLC) message after a release (REL) message is sent. Timers RELRLC and RELRLC2 start when an REL message is sent, and stop when an RLC message is received or timer RELRLC2 expires.  If no RLC message is received by the time RELRLC expires, a second REL message is sent and timer RELRLC is reset. This process continues until timer RELRLC2 expires.  The default value is 6 (6 s).
	REANSWER	60 to 120	<i>Reanswer timer</i> Enter the time, in seconds, to wait for a resume (RES) message after sending a network-initiated suspend (SUS) message.  This timer starts when the controlling switch receives an SUS message and stops when an RES message is received.  The default value is 90 (90 s).



## C7UPTMR signaling protocol AISUP (continued)

### Field descriptions for conditional datafill (Sheet 2 of 11)

Field	Subfield or refinement	Entry	Explanation and action
	ACM	20 to 30	<p><i>Address complete timer</i> Enter the time, in seconds, to wait for an address complete message (ACM) or a connection (CON) message after sending an initial address message (IAM) or subsequent address message (SAM).</p> <p>The timer starts when an IAM or SAM is sent and stops when an ACM or a CON message is received.</p> <p>When the timer expires, a REL message is sent and all equipment and connections are released.</p> <p>The default value is 25 (25 s).</p>
	COT	10 to 15	<p><i>Continuity timer</i> Enter the time, in seconds, to wait for a continuity (COT) or REL message after responding to a continuity test request in the IAM.</p> <p>The timer starts when a continuity test request is received in the IAM and stops when a continuity message is received.</p> <p>When the timer expires, all equipment and connections into the national network are released and an REL message is sent.</p> <p>The default value is 13 (13 s).</p> <p><b>Note:</b> To accommodate DMS-300 switch requirements, this timer can be datafilled.</p>

## C7UPTMR signaling protocol AISUP (continued)

### Field descriptions for conditional datafill (Sheet 3 of 11)

Field	Subfield or refinement	Entry	Explanation and action
	ANSWER	60 to 240	<p><i>Answer timer</i> Enter the time, in seconds, to wait for an answer (ANS) message, after an ACM message is received.</p> <p>This timer starts when the national controlling or outgoing international switch receives an ACM, and stops when an ANS message is received.</p> <p>When the timer expires, all connections are released and an REL message is sent back.</p> <p>The default value is 180 (180 s).</p>
	IDGTAFT	4 to 6	<p><i>Interdigit timer after receipt of minimum number of digits</i> Enter the time allowed, in seconds, between the last digit received and receiving the next digit after the minimum number of digits required for routing have been received.</p> <p>This timer starts on the reception of an IAM or an IAM with additional information (IAI) or on each SAM or SAM with one signal (SAO), after the minimum number of digits required for routing have been received, and stops when the next address message is received.</p> <p>When the timer expires, this indicates the end of dialing.</p> <p>The default value is 5 (5 s).</p>
	INRINF	12 to 15	<p><i>Information request to information receipt timer</i> Enter the time allowed, in seconds, between sending an information request (INR) message and receiving an information (INF) message.</p> <p>The timer starts when the INR message is sent and stops when the INF message is received.</p> <p>When the timer expires, the call is released.</p> <p>The default value is 13 (13 s).</p>

## C7UPTMR signaling protocol AISUP (continued)

### Field descriptions for conditional datafill (Sheet 4 of 11)

Field	Subfield or refinement	Entry	Explanation and action
	IDGTBFR	15 to 20	<p><i>Interdigit timer before receipt of minimum number of digits</i></p> <p>Enter the time allowed, in seconds, between the last digit received and the next digit received, before the minimum number of digits required for routing have been received.</p> <p>This timer starts when an IAM or IAI is received or when each SAM or SAO is received, before the minimum number of digits required for routing have been received, and stops when the next address message is received.</p> <p>When the timer expires, an REL message is sent.</p> <p>The default value is 15 (15 s).</p>
	RSCRESP	4 to 60	<p><i>Reset circuit to reset circuit response timer</i></p> <p>Enter the time, in seconds, to wait for a reset circuit (RSC) acknowledgement message, an RLC message, after the RSC message is sent. Timers RSCRESP and RSCRESP2 start when an RSC message is sent, and stop when an RLC message is received or timer RSCRESP2 expires.</p> <p>If no RLC message is received by the time RSCRESP expires, a second RSC message is sent and timer RSCRESP is reset. This process continues until the reset circuit response secondary timer, RSCRESP2, expires.</p> <p>The default value is 13 (13 s).</p> <p><b>Note:</b> The type of acknowledgement received depends on initial conditions.</p>

---

**C7UPTMR signaling protocol AISUP** (continued)

---

**Field descriptions for conditional datafill (Sheet 5 of 11)**

<b>Field</b>	<b>Subfield or refinement</b>	<b>Entry</b>	<b>Explanation and action</b>
	RSCRESP2	60 to 320	<p><i>Reset circuit to reset circuit response secondary timer</i></p> <p>Enter the time, in seconds, to wait for a response to the RSC message after the initial RSC message is sent.</p> <p>Timers RSCRESP2 and RSCRESP start at the same time.</p> <p>When timer RSCRESP2 expires, timer RSCRESP stops, the RSC message is sent, and timer RSCRESP2 restarts. Timer RSCRESP is not restarted. The RSC message is resent at RSCRESP2 intervals until an RLC message is received.</p> <p>The default value is 60 (60 s).</p>
	RELRLC2	60 to 320	<p><i>Release to release complete secondary timer</i></p> <p>Enter the time, in seconds, to wait for a response to the REL message after the initial REL message is sent.</p> <p>Timers RELRLC2 and RELRLC start at the same time.</p> <p>When timer RELRLC2 expires, timer RELRLC stops, the REL message is sent, and timer RELRLC2 restarts. Timer RELRLC is not restarted. The REL message is resent at RELRLC2 intervals until an RLC message is received.</p> <p>The default value is 60 (60 s).</p>

## C7UPTMR signaling protocol AISUP (continued)

### Field descriptions for conditional datafill (Sheet 6 of 11)

Field	Subfield or refinement	Entry	Explanation and action
	BLOBLA	6 to 60	<p><i>Blocking to blocking acknowledgement timer</i> Enter the time, in seconds, to wait for a blocking acknowledgement (BLA) message after blocking (BLO) message is sent. If a BLO message is sent, timers BLOBLA and BLOBLA2 start and wait for a BLA message.</p> <p>If no BLA message is received by the time BLOBLA expires, a second BLO message is sent and timer BLOBLA is reset. This process continues until timer BLOBLA2 expires.</p> <p>Timer BLOBLA starts when a BLO message is sent and stops when a BLA message is received or when timer BLOBLA2 expires.</p> <p>The default value is 6 (6 s).</p>
	BLOBLA2	60 to 900	<p><i>Blocking to blocking acknowledgement secondary timer</i> Enter the time, in seconds, to wait for a response to the BLO message after the initial BLO message is sent.</p> <p>Timers BLOBLA and BLOBLA2 start at the same time.</p> <p>When timer BLOBLA2 expires, timer BLOBLA stops, the BLO message is sent, and timer BLOBLA2 restarts. Timer BLOBLA is not restarted. The BLO message is resent at BLOBLA2 intervals until a BLA message is received.</p> <p>The default value is 60 (60 s).</p>

## C7UPTMR signaling protocol AISUP (continued)

### Field descriptions for conditional datafill (Sheet 7 of 11)

Field	Subfield or refinement	Entry	Explanation and action
	UBLUBA	6 to 60	<p><i>Unblocking to unblocking acknowledgement timer</i></p> <p>Enter the time, in seconds, to wait for an unblocking acknowledgement (UBA) message after a release (UBL) message is sent. If a UBL message is sent, timers UBLUBA and UBLUBA2 start and wait for a UBA message.</p> <p>If no UBA message is received by the time UBLUBA expires, a second UBL message is sent and timer UBLUBA is reset. This process continues until timer UBLUBA2 expires.</p> <p>Timer UBLUBA starts when a UBL message is sent and stops when a UBA message is received or when timer UBLUBA2 expires.</p> <p>The default value is 6 (6 s).</p>
	UBLUBA2	60 to 900	<p><i>Unblocking to unblocking acknowledgement secondary timer</i></p> <p>Enter the time, in seconds, to wait for a response to the UBL message after the initial UBL message is sent.</p> <p>Timers UBLUBA2 and UBLUBA start at the same time.</p> <p>When timer UBLUBA2 expires, timer UBLUBA stops, the UBL message is sent, and timer UBLUBA2 restarts. Timer UBLUBA is not restarted. The UBL message is resent at UBLUBA2 intervals until a UBA message is received.</p> <p>The default value is 60 (60 s).</p>

## C7UPTMR signaling protocol AISUP (continued)

### Field descriptions for conditional datafill (Sheet 8 of 11)

Field	Subfield or refinement	Entry	Explanation and action
	GRPBLOBLA	8 to 60	<p><i>Group-blocking to group- blocking acknowledgement timer</i></p> <p>Enter the time, in seconds, to wait for a circuit group blocking acknowledgement (CGBA) message after the circuit group blocking (CGB) message is sent. Timers GRPBLOBLA and GRPBLOBLA2 start when a CGB message is sent, and stop when a CGBA message is received or timer GRPBLOBLA2 expires.</p> <p>If no CGBA message is received by the time GRPBLOBLA expires, a second CGB message is sent and timer GRPBLOBLA is reset.</p> <p>The default value is 12 (12 s).</p>
	GRPBLOBLA2	60 to 900	<p><i>Group-blocking to group- blocking acknowledgement secondary timer</i></p> <p>Enter the time, in seconds, to wait for the CGBA message after the initial group CGB message is sent.</p> <p>Timers GRPBLOBLA and GRPBLOBLA2 start at the same time.</p> <p>When timer GRPBLOBLA2 expires, timer GRPBLOBLA stops, the CGBA message is sent, and timer GRPBLOBLA2 restarts. Timer GRPBLOBLA is not restarted. The CGB message is resent at GRPBLOBLA2 intervals until a CGBA message is received.</p> <p>The default value is 60 (60 s).</p>

## C7UPTMR signaling protocol AISUP (continued)

### Field descriptions for conditional datafill (Sheet 9 of 11)

Field	Subfield or refinement	Entry	Explanation and action
	GRPUBLUBLA	8 to 60	<p><i>Group-unblocking to group-unblocking acknowledgement timer</i></p> <p>Enter the time, in seconds, to wait for a circuit group unblocking acknowledgement (CGUA) message after a circuit group unblocking (CGU) message is sent. Timers GRPUBLUBLA and GRPUBLUBLA2 start when a CGU message is sent, and stop when a CGUA message is received or timer GRPUBLUBLA2 expires.</p> <p>If no CGUA message is received by the time GRPUBLUBLA expires, a second CGU message is sent and timer GRPUBLUBLA is reset. This process continues until timer GRPUBLUBLA2 expires.</p> <p>The default value is 12 (12 s).</p>
	GRPUBLUBLA2	60 to 900	<p><i>Group-unblocking to group-unblocking acknowledgement secondary timer</i></p> <p>Enter the time, in seconds, to wait for a response to the CGU message after the initial CGU message is sent.</p> <p>Timers GRPUBLUBLA2 and GRPUBLUBLA start at the same time.</p> <p>When timer GRPUBLUBLA2 expires, timer GRPUBLUBLA stops, the CGU message is sent, and timer GRPUBLUBLA2 restarts. Timer GRPUBLUBLA is not restarted. The CGU message is resent at GRPUBLUBLA2 intervals until a CGUA message is received.</p> <p>The default value is 60 (60 s).</p>



**C7UPTMR signaling protocol AISUP** (continued)

## Field descriptions for conditional datafill (Sheet 10 of 11)

Field	Subfield or refinement	Entry	Explanation and action
	GRPRSCRESP	8 to 60	<p><i>Group-reset circuit to group-reset circuit response timer</i></p> <p>Enter the time, in seconds, to wait for a group reset acknowledgement (GRA) message after a group reset (GRS) message is sent. Timers GRPRSCRESP and GRPRSCRESP2 start when a GRS message is sent, and stop when an GRA message is received or timer GRPRSCRESP2 expires.</p> <p>If no GRA message is received by the time GRPRSCRESP expires, a second GRS message is sent and timer GRPRSCRESP is reset. This process continues until timer GRPRSCRESP2 expires.</p> <p>The default value is 12 (12 s).</p>
	GRPRSCRESP2	60 to 900	<p><i>Group-reset to group-reset response secondary timer</i></p> <p>Enter the time, in seconds, to wait for a response to the GRS message after the initial GRS message is sent.</p> <p>Timers GRPRSCRESP2 and GRPRSCRESP start at the same time.</p> <p>When timer GRPRSCRESP2 expires, timer GRPRSCRESP stops, the GRS message is sent, and timer GRPRSCRESP2 restarts. Timer GRPRSCRESP is not restarted. The GRS message is resent at GRPRSCRESP2 intervals until a GRA message is received.</p> <p>The default value is 60 (60 s).</p>
OPTIONS (BCS36-)		See subfields	<p><i>Timer options list</i></p> <p>Enter OPTION and datafill its subfields.</p>

---

**C7UPTMR signaling protocol AISUP** (continued)

---

**Field descriptions for conditional datafill (Sheet 11 of 11)**

<b>Field</b>	<b>Subfield or refinement</b>	<b>Entry</b>	<b>Explanation and action</b>
	OPTION	MCD	<p><i>Option</i></p> <p>Enter MCD for minimum call duration and datafill subfield MCD_TIMER.</p> <p>Enter \$ if no refinements have been defined.</p>
	MCD_TIMER	0 to 700	<p>Enter the time, in 10-ms units, between receiving an answer (ANS) message and sending a release message (REL).</p> <p>The MCD timer starts after an ANS message is received and stops after a REL message is sent.</p> <p>If a suspend (SUS) message is received while the MCD timer is active, a disconnect time is set and a REL message is sent when the timer expires.</p> <p>If a resume (RES) message is received before the MCD timer expires, the timer is cleared and no REL message is sent.</p> <p>A value other than 0 must be entered in order to activate the timer.</p> <p>The default value is 0.</p>

## C7UPTMR signaling protocol AISUP (continued)

### C7UPDIR = IC

If the entry in subfield C7UPDIR is IC, datafill subfield ICPROT and refinements as described in the following table, then datafill field OPTIONS.

#### Field descriptions for conditional datafill (Sheet 1 of 10)

Field	Subfield or refinement	Entry	Explanation and action
	ICPROT	AISUP	<i>Incoming protocol</i> Enter AISUP to specify that the timers are used for the Australian ISUP in DMS-100 switches.
	RELRLC	4 to 60	<i>Release to release complete timer</i> Enter the time, in seconds, to wait for a release complete (RLC) message after a release (REL) message is sent. Timers RELRLC and RELRLC2 start when a REL message is sent. They stop when an RLC message is received or timer RELRLC2 expires.  If no RLC message is received by the time RELRLC expires, a second REL message is sent and timer RELRLC is reset. This process continues until timer RELRLC2 expires.  The default value is 6 (6 s).
	REANSWER	60 to 120	<i>Reanswer timer</i> Enter the time, in seconds, to wait for a resume (RES) message after sending a network-initiated suspend (SUS) message.  This timer starts when the controlling switch receives an SUS message and stops when an RES message is received.  The default value is 90 (90 s).  <b>Note:</b> To accommodate DMS-300 switch requirements, this timer can be datafilled.

---

**C7UPTMR signaling protocol AISUP** (continued)

---

**Field descriptions for conditional datafill (Sheet 2 of 10)**

Field	Subfield or refinement	Entry	Explanation and action
	COT	10 to 15	<p><i>Continuity timer</i></p> <p>Enter the time, in seconds, to wait for a continuity (COT) or REL message after responding to a continuity test request in the initial address message (IAM). The timer starts if a continuity test request is received in the IAM and stops when a COT message is received.</p> <p>When the timer expires, all equipment and connections to the national network are released and an REL message is sent.</p> <p>The default value is 13 (13 s).</p> <p><b>Note:</b> To accommodate DMS-300 switch requirements, this timer can be datafilled.</p>
	ANSWER	60 to 240	<p><i>Answer timer</i></p> <p>Enter the time, in seconds, to wait for an answer (ANS) message, after an address complete message (ACM) is received.</p> <p>This timer starts when the national controlling or outgoing international switch receives an ACM message, and stops when an ANS message is received. When the timer expires, all connections are released and an REL message is sent back.</p> <p>The default value is 180 (180 s).</p>

## C7UPTMR signaling protocol AISUP (continued)

### Field descriptions for conditional datafill (Sheet 3 of 10)

Field	Subfield or refinement	Entry	Explanation and action
	IDGTAFT	4 to 6	<p><i>Interdigit timer after receipt of minimum number of digits</i></p> <p>Enter the time allowed, in seconds, between the last digit received and the next digit received, after the minimum number of digits required for routing were received.</p> <p>This timer starts when each subsequent address message (SAM) or SAM with one signal (SAO) is received, after the minimum number of digits required for routing were received, and stops when the next SAM or SAO is received.</p> <p>When the timer expires, routing can commence.</p> <p>The default value is 4 (4 s).</p>
	INRINF	12 to 15	<p><i>Information request to information receipt timer</i></p> <p>Enter the time allowed, in seconds, between the sending of an information request (INR) message and reception of an information (INF) message.</p> <p>The timer starts when the INR message is sent and stops when the INF message is received.</p> <p>When the timer expires, the call is released.</p> <p>The default value is 13 (13 s).</p>

## C7UPTMR signaling protocol AISUP (continued)

### Field descriptions for conditional datafill (Sheet 4 of 10)

Field	Subfield or refinement	Entry	Explanation and action
	IDGTBFR	15 to 20	<p><i>Interdigit timer before receipt of minimum number of digits</i></p> <p>Enter the time allowed, in seconds, between the last digit received and the next digit received, before the minimum number of digits required for routing were received.</p> <p>This timer starts when an IAM or IAM with additional information (IAI) is received or when each SAM or SAO is received, before the minimum number of digits required for routing were received, and stops when the next address message is received.</p> <p>When the timer expires, a REL message is sent.</p> <p>The default value is 15 (15 s).</p>
	RSCRESP	4 to 60	<p><i>Reset-circuit to reset-circuit response timer</i></p> <p>Enter the time, in seconds, to wait for a reset circuit (RSC) acknowledgement message or an RLC message after the RSC message is sent. Timers RSCRESP and RSCRESP2 start when an RSC message is sent and stop when an RLC message is received or timer RSCRESP2 expires.</p> <p>If no RLC message is received by the time RSCRESP expires, a second RSC message is sent and timer RSCRESP is reset. This process continues until the reset circuit response secondary timer, RSCRESP2, expires.</p> <p>The default value is 13 (13 s).</p> <p><b>Note:</b> The type of acknowledgement received depends on initial conditions.</p>

## C7UPTMR signaling protocol AISUP (continued)

### Field descriptions for conditional datafill (Sheet 5 of 10)

Field	Subfield or refinement	Entry	Explanation and action
	RSCRESP2	60 to 320	<p><i>Reset-circuit to reset-circuit response secondary timer</i></p> <p>Enter the time, in seconds, to wait for a response to the RSC message after the initial RSC message is sent.</p> <p>Timers RSCRESP2 and RSCRESP start at the same time.</p> <p>When timer RSCRESP2 expires, timer RSCRESP stops, the RSC message is sent, and timer RSCRESP2 restarts. Timer RSCRESP is not restarted. The RSC message is resent at RSCRESP2 intervals until an RLC message is received.</p> <p>The default value is 60 (60 s).</p>
	RELRLC2	60 to 320	<p><i>Release to release complete secondary timer</i></p> <p>Enter the time, in seconds, to wait for a response to the REL message after the initial REL message is sent.</p> <p>Timers RELRLC2 and RELRLC start at the same time.</p> <p>When timer RELRLC2 expires, timer RELRLC stops, the REL message is sent, and timer RELRLC2 restarts. Timer RELRLC is not restarted. The REL message is resent at RELRLC2 intervals until an RLC message is received.</p> <p>The default value is 60 (60 s).</p>

---

**C7UPTMR signaling protocol AISUP** (continued)

---

**Field descriptions for conditional datafill (Sheet 6 of 10)**

Field	Subfield or refinement	Entry	Explanation and action
	BLOBLA	6 to 60	<p><i>Blocking to blocking-acknowledgement timer</i></p> <p>Enter the time, in seconds, to wait for a blocking-acknowledgement (BLA) message after blocking (BLO) message is sent. If a BLO message is sent, timers BLOBLA and BLOBLA2 start and wait for a BLA message.</p> <p>If no BLA message is received by the time BLOBLA expires, a second BLO message is sent and timer BLOBLA is reset. This process continues until timer BLOBLA2 expires.</p> <p>Timer BLOBLA starts when a BLO message is sent and stops when a BLA message is received or when timer BLOBLA2 expires.</p> <p>The default value is 6 (6 s).</p>
	BLOBLA2	60 to 900	<p><i>Blocking to blocking-acknowledgement secondary timer</i></p> <p>Enter the time, in seconds, to wait for a response to the BLO message after the initial BLO message is sent.</p> <p>Timers BLOBLA and BLOBLA2 start at the same time.</p> <p>When timer BLOBLA2 expires, timer BLOBLA stops, the BLO message is sent, and timer BLOBLA2 restarts. Timer BLOBLA is not restarted. The BLO message is resent at BLOBLA2 intervals until a BLA message is received.</p> <p>The default value is 60 (60 s).</p>



## C7UPTMR signaling protocol AISUP (continued)

### Field descriptions for conditional datafill (Sheet 7 of 10)

Field	Subfield or refinement	Entry	Explanation and action
	UBLUBA	6 to 60	<p>Enter the time, in seconds, to wait for an unblocking acknowledgement (UBA) message after a release (UBL) message is sent. If a UBL message is sent, timers UBLUBA and UBLUBA2 start and wait for a UBA message.</p> <p>If no UBA message is received by the time UBLUBA expires, a second UBL message is sent and timer UBLUBA is reset. This process continues until timer UBLUBA2 expires.</p> <p>Timer UBLUBA starts when a UBL message is sent and stops when a UBA message is received or when timer UBLUBA2 expires.</p> <p>The default value is 6 (6 s).</p>
	UBLUBA2	60 to 900	<p><i>Unblocking to unblocking-acknowledgement secondary timer</i></p> <p>Enter the time, in seconds, to wait for a response to the UBL message after the initial UBL message is sent.</p> <p>Timers UBLUBA2 and UBLUBA start at the same time.</p> <p>When timer UBLUBA2 expires, timer UBLUBA stops, the UBL message is sent, and timer UBLUBA2 restarts. Timer UBLUBA is not restarted. The UBL message is resent at UBLUBA2 intervals until a UBA message is received.</p> <p>The default value is 60 (60 s).</p>

## C7UPTMR signaling protocol AISUP (continued)

### Field descriptions for conditional datafill (Sheet 8 of 10)

Field	Subfield or refinement	Entry	Explanation and action
	GRPBLOBLA	8 to 60	<p><i>Group-blocking to group-blocking acknowledgement timer</i></p> <p>Enter the time, in seconds, to wait for a circuit group blocking acknowledgement (CGBA) message after the circuit group blocking (CGB) message is sent. Timers GRPBLOBLA and GRPBLOBLA2 start when a CGB message is sent, and stop when a CGBA message is received or timer GRPBLOBLA2 expires.</p> <p>If no CGBA message is received by the time GRPBLOBLA expires, a second CGB message is sent and timer GRPBLOBLA is reset.</p> <p>The default value is 12 (12 s).</p>
	GRPBLOBLA2	60 to 900	<p><i>Group-blocking to group-blocking acknowledgement secondary timer</i></p> <p>Enter the time, in seconds, to wait for the CGBA message after the initial group CGB message is sent.</p> <p>Timers GRPBLOBLA and GRPBLOBLA2 start at the same time.</p> <p>When timer GRPBLOBLA2 expires, timer GRPBLOBLA stops, the CGBA message is sent, and timer GRPBLOBLA2 restarts. Timer GRPBLOBLA is not restarted. The CGB message is resent at GRPBLOBLA2 intervals until a CGBA message is received.</p> <p>The default value is 60 (60 s).</p>

**C7UPTMR signaling protocol AISUP** (continued)

## Field descriptions for conditional datafill (Sheet 9 of 10)

Field	Subfield or refinement	Entry	Explanation and action
	GRPUBLUBLA	8 to 60	<p><i>Group-unblocking to group-unblocking acknowledgement timer</i></p> <p>Enter the time, in seconds, to wait for a circuit group unblocking acknowledgement (CGUA) message after a circuit group unblocking (CGU) message is sent. Timers GRPUBLUBLA and GRPUBLUBLA2 start when a CGU message is sent, and stop when a CGUA message is received or timer GRPUBLUBLA2 expires.</p> <p>If no CGUA message is received by the time GRPUBLUBLA expires, a second CGU message is sent and timer GRPUBLUBLA is reset. This process continues until timer GRPUBLUBLA2 expires.</p> <p>The default value is 12 (12 s).</p>
	GRPUBLUBLA2	60 to 900	<p><i>Group-unblocking to group-unblocking acknowledgement secondary timer</i></p> <p>Enter the time, in seconds, to wait for a response to the CGU message after the initial CGU message is sent.</p> <p>Timers GRPUBLUBLA2 and GRPUBLUBLA start at the same time.</p> <p>When timer GRPUBLUBLA2 expires, timer GRPUBLUBLA stops, the CGU message is sent, and timer GRPUBLUBLA2 restarts. Timer GRPUBLUBLA is not restarted. The CGU message is resent at GRPUBLUBLA2 intervals until a CGUA message is received.</p> <p>The default value is 60 (60 s).</p>

## C7UPTMR signaling protocol AISUP (continued)

### Field descriptions for conditional datafill (Sheet 10 of 10)

Field	Subfield or refinement	Entry	Explanation and action
	GRPRSCRESP	8 to 60	<p><i>Group-reset circuit to group-reset circuit response timer</i></p> <p>Enter the time, in seconds, to wait for a group reset acknowledgement (GRA) message after a group reset (GRS) message is sent. Timers GRPRSCRESP and GRPRSCRESP2 start when a GRS message is sent, and stop when an GRA message is received or timer GRPRSCRESP2 expires.</p> <p>If no GRA message is received by the time GRPRSCRESP expires, a second GRS message is sent and timer GRPRSCRESP is reset. This process continues until timer GRPRSCRESP2 expires.</p> <p>The default value is 12 (12 s).</p>
	GRPRSCRESP2	60 to 900	<p><i>Group-reset to group-reset response secondary timer</i></p> <p>Enter the time, in seconds, to wait for a response to the GRS message after the initial GRS message is sent.</p> <p>Timers GRPRSCRESP2 and GRPRSCRESP start at the same time.</p> <p>When timer GRPRSCRESP2 expires, timer GRPRSCRESP stops, the GRS message is sent, and timer GRPRSCRESP2 restarts. Timer GRPRSCRESP is not restarted. The GRS message is resent at GRPRSCRESP2 intervals until a GRA message is received.</p> <p>The default value is 60 (60 s).</p>
OPTIONS (BCS36-)		\$	<p><i>Timer options list</i></p> <p>No refinements defined. Enter \$.</p>

## C7UPTMR signaling protocol AISUP (continued)

### C7UPDIR = OG

If the entry in subfield C7UPDIR is OG, datafill subfield OGPROT and refinements as described in the following table, then datafill field OPTIONS.

#### Field descriptions for conditional datafill (Sheet 1 of 10)

Field	Subfield or refinement	Entry	Explanation and action
	OGPROT	AISUP	<i>Outgoing protocol</i> Enter AISUP to specify that the timers are used for the Australian ISUP in DMS-100 switches.
	RELRLC	4 to 60	<i>Release to release-complete timer</i> Enter the time, in seconds, to wait for a release complete (RLC) message after a release (REL) message is sent. Timers RELRLC and RELRLC2 start when a REL message is sent, and stop when an RLC message is received or timer RELRLC2 expires.  If no RLC message is received by the time RELRLC expires, a second REL message is sent and timer RELRLC is reset. This process continues until timer RELRLC2 expires.  The default value is 6 (6 s).
	REANSWER	60 to 120	<i>Reanswer timer</i> Enter the time, in seconds, to wait for a resume (RES) message after sending a network-initiated suspend (SUS) message.  This timer starts when the controlling switch receives an SUS message and stops when an RES message is received.  The default value is 90 (90 s).

---

**C7UPTMR signaling protocol AISUP** (continued)

---

**Field descriptions for conditional datafill (Sheet 2 of 10)**

Field	Subfield or refinement	Entry	Explanation and action
	ACM	20 to 30	<p><i>Address-complete timer</i> Enter the time, in seconds, to wait for an address complete message (ACM) or a connection (CON) message after sending an initial address message (IAM) or subsequent address message (SAM).</p> <p>The timer starts when an IAM or SAM is sent and stops when an ACM or a CON message is received.</p> <p>When the timer expires, an REL message is sent and all equipment and connections are released.</p> <p>The default value is 25 (25 s).</p>
	ANSWER	60 to 240	<p><i>Answer timer</i> Enter the time, in seconds, to wait for an answer (ANS) message, after an ACM is received.</p> <p>This timer starts when the national controlling or outgoing international switch receives an ACM and stops when an ANS message is received.</p> <p>When the timer expires, all connections are released and an REL message is sent back.</p> <p>The default value is 180 (180 s).</p>

## C7UPTMR signaling protocol AISUP (continued)

### Field descriptions for conditional datafill (Sheet 3 of 10)

Field	Subfield or refinement	Entry	Explanation and action
	RSCRESP	4 to 60	<p><i>Reset-circuit to reset-circuit response timer</i> Enter the time, in seconds, to wait for a reset circuit (RSC) acknowledgement message, an RLC message, after the RSC message is sent. Timers RSCRESP and RSCRESP2 start when an RSC message is sent, and stop when an RLC message is received or timer RSCRESP2 expires.</p> <p>If no RLC message is received by the time RSCRESP expires, a second RSC message is sent and timer RSCRESP is reset. This process continues until the reset circuit response secondary timer, RSCRESP2, expires.</p> <p>The default value is 13 (13 s).</p> <p><b>Note:</b> The type of acknowledgement received depends on initial conditions.</p>
	RSCRESP2	60 to 320	<p><i>Reset-circuit to reset-circuit response secondary timer</i> Enter the time, in seconds, to wait for a response to the RSC message after the initial RSC message is sent.</p> <p>Timers RSCRESP2 and RSCRESP start at the same time.</p> <p>When timer RSCRESP2 expires, timer RSCRESP stops, the RSC message is sent, and timer RSCRESP2 restarts. Timer RSCRESP is not restarted. The RSC message is resent at RSCRESP2 intervals until an RLC message is received.</p> <p>The default value is 60 (60 s).</p>

---

**C7UPTMR signaling protocol AISUP** (continued)

---

**Field descriptions for conditional datafill (Sheet 4 of 10)**

Field	Subfield or refinement	Entry	Explanation and action
	RELRLC2	60 to 320	<p><i>Release to release-complete secondary timer</i></p> <p>Enter the time, in seconds, to wait for a response to the REL message after the initial REL message is sent.</p> <p>Timers RELRLC2 and RELRLC start at the same time.</p> <p>When timer RELRLC2 expires, timer RELRLC stops, the REL message is sent, and timer RELRLC2 restarts. Timer RELRLC is not restarted. The REL message is resent at RELRLC2 intervals until an RLC message is received.</p> <p>The default value is 60 (60 s).</p>
	BLOBLA	6 to 60	<p><i>Blocking to blocking-acknowledgement timer</i></p> <p>Enter the time, in seconds, to wait for a blocking acknowledgement (BLA) message after blocking (BLO) message is sent. If a BLO message is sent, timers BLOBLA and BLOBLA2 start and wait for a BLA message.</p> <p>If no BLA message is received by the time BLOBLA expires, a second BLO message is sent and timer BLOBLA is reset. This process continues until timer BLOBLA2 expires.</p> <p>Timer BLOBLA starts when a BLO message is sent and stops when a BLA message is received or when timer BLOBLA2 expires.</p> <p>The default value is 6 (6 s).</p>



## C7UPTMR signaling protocol AISUP (continued)

### Field descriptions for conditional datafill (Sheet 5 of 10)

Field	Subfield or refinement	Entry	Explanation and action
	BLOBLA2	60 to 900	<p><i>Blocking to blocking-acknowledgement secondary timer</i></p> <p>Enter the time, in seconds, to wait for a response to the BLO message after the initial BLO message is sent.</p> <p>Timers BLOBLA and BLOBLA2 start at the same time.</p> <p>When timer BLOBLA2 expires, timer BLOBLA stops, the BLO message is sent, and timer BLOBLA2 restarts. Timer BLOBLA is not restarted. The BLO message is resent at BLOBLA2 intervals until a BLA message is received.</p> <p>The default value is 60 (60 s).</p>
	UBLUBA	6 to 60	<p><i>Unblocking to unblocking-acknowledgement timer</i></p> <p>Enter the time, in seconds, to wait for an unblocking acknowledgement (UBA) message after a release (UBL) message is sent. If a UBL message is sent, timers UBLUBA and UBLUBA2 start and wait for a UBA message.</p> <p>If no UBA message is received by the time UBLUBA expires, a second UBL message is sent and timer UBLUBA is reset. This process continues until timer UBLUBA2 expires.</p> <p>Timer UBLUBA starts when a UBL message is sent and stops when a UBA message is received or when timer UBLUBA2 expires.</p> <p>The default value is 6 (6 s).</p>

---

**C7UPTMR signaling protocol AISUP** (continued)

---

**Field descriptions for conditional datafill (Sheet 6 of 10)**

Field	Subfield or refinement	Entry	Explanation and action
	UBLUBA2	60 to 900	<p><i>Unblocking to unblocking-acknowledgement secondary timer</i></p> <p>Enter the time, in seconds, to wait for a response to the UBL message after the initial UBL message is sent.</p> <p>Timers UBLUBA2 and UBLUBA start at the same time.</p> <p>When timer UBLUBA2 expires, timer UBLUBA stops, the UBL message is sent, and timer UBLUBA2 restarts. Timer UBLUBA is not restarted. The UBL message is resent at UBLUBA2 intervals until a UBA message is received.</p> <p>The default value is 60 (60 s).</p>
	GRPBLOBLA	8 to 60	<p><i>Group-blocking to group-blocking acknowledgement timer</i></p> <p>Enter the time, in seconds, to wait for a circuit group blocking acknowledgement (CGBA) message after the circuit group blocking (CGB) message is sent. Timers GRPBLOBLA and GRPBLOBLA2 start when a CGB message is sent, and stop when a CGBA message is received or timer GRPBLOBLA2 expires.</p> <p>If no CGBA message is received by the time GRPBLOBLA expires, a second CGB message is sent and timer GRPBLOBLA is reset.</p> <p>The default value is 12 (12 s).</p>

## C7UPTMR signaling protocol AISUP (continued)

### Field descriptions for conditional datafill (Sheet 7 of 10)

Field	Subfield or refinement	Entry	Explanation and action
	GRPBLOBLA2	60 to 900	<p><i>Group-blocking to group- blocking acknowledgement secondary timer</i></p> <p>Enter the time, in seconds, to wait for the CGBA message after the initial group CGB message is sent.</p> <p>Timers GRPBLOBLA and GRPBLOBLA2 start at the same time.</p> <p>When timer GRPBLOBLA2 expires, timer GRPBLOBLA stops, the CGBA message is sent, and timer GRPBLOBLA2 restarts. Timer GRPBLOBLA is not restarted. The CGB message is resent at GRPBLOBLA2 intervals until a CGBA message is received.</p> <p>The default value is 60 (60 s).</p>
	GRPUBLUBLA	8 to 60	<p><i>Group-unblocking to group-unblocking acknowledgement timer</i></p> <p>Enter the time, in seconds, to wait for a circuit group unblocking acknowledgement (CGUA) message after a circuit group unblocking (CGU) message is sent. Timers GRPUBLUBLA and GRPUBLUBLA2 start when a CGU message is sent, and stop when a CGUA message is received or timer GRPUBLUBLA2 expires.</p> <p>If no CGUA message is received by the time GRPUBLUBLA expires, a second CGU message is sent and timer GRPUBLUBLA is reset. This process continues until timer GRPUBLUBLA2 expires.</p> <p>The default value is 12 (12 s).</p>

## C7UPTMR signaling protocol AISUP (continued)

### Field descriptions for conditional datafill (Sheet 8 of 10)

Field	Subfield or refinement	Entry	Explanation and action
	GRPUBLUBLA2	60 to 900	<p><i>Group-unblocking to group-unblocking acknowledgement secondary timer</i> Enter the time, in seconds, to wait for a response to the CGU message after the initial CGU message is sent.</p> <p>Timers GRPUBLUBLA2 and GRPUBLUBLA start at the same time.</p> <p>When timer GRPUBLUBLA2 expires, timer GRPUBLUBLA stops, the CGU message is sent, and timer GRPUBLUBLA2 restarts. Timer GRPUBLUBLA is not restarted. The CGU message is resent at GRPUBLUBLA2 intervals until a CGUA message is received.</p> <p>The default value is 60 (60 s).</p>
	GRPRSCRESP	8 to 60	<p><i>Group-reset circuit to group-reset circuit response timer</i> Enter the time, in seconds, to wait for a group reset acknowledgement (GRA) message after a group reset (GRS) message is sent. Timers GRPRSCRESP and GRPRSCRESP2 start when a GRS message is sent, and stop when an GRA message is received or timer GRPRSCRESP2 expires.</p> <p>If no GRA message is received by the time GRPRSCRESP expires, a second GRS message is sent and timer GRPRSCRESP is reset. This process continues until timer GRPRSCRESP2 expires.</p> <p>The default value is 12 (12 s).</p>

## C7UPTMR signaling protocol AISUP (continued)

### Field descriptions for conditional datafill (Sheet 9 of 10)

Field	Subfield or refinement	Entry	Explanation and action
	GRPRSCRESP2	60 to 900	<p><i>Group-reset to group-reset response secondary timer</i></p> <p>Enter the time, in seconds, to wait for a response to the GRS message after the initial GRS message is sent.</p> <p>Timers GRPRSCRESP2 and GRPRSCRESP start at the same time.</p> <p>When timer GRPRSCRESP2 expires, timer GRPRSCRESP stops, the GRS message is sent, and timer GRPRSCRESP2 restarts. Timer GRPRSCRESP is not restarted. The GRS message is resent at GRPRSCRESP2 intervals until a GRA message is received.</p> <p>The default value is 60 (60 s).</p>
OPTIONS (BCS36-)		See subfields	<p><i>Timer options list</i></p> <p>Enter OPTION and datafill its subfields.</p>
	OPTION	MCD	<p><i>Option</i></p> <p>Enter MCD for minimum call duration and datafill subfield MCD_TIMER.</p> <p>Enter \$ if no refinements have been defined.</p>

**C7UPTMR signaling protocol AISUP (end)****Field descriptions for conditional datafill (Sheet 10 of 10)**

Field	Subfield or refinement	Entry	Explanation and action
	OPTION	MCD	<p><i>Option</i></p> <p>Enter MCD for minimum call duration and datafill subfield MCD_TIMER.</p> <p>Enter \$ if no refinements have been defined.</p>
	MCD_TIMER	0 to 700	<p>Enter the time, in 10-ms units, between receiving an answer (ANS) message and sending a release message (REL).</p> <p>The MCD timer starts after an ANS message is received and stops after a REL message is sent.</p> <p>If a suspend (SUS) message is received while the MCD timer is active, a disconnect time is set and a REL message is sent when the timer expires.</p> <p>If a resume (RES) message is received before the MCD timer expires, the timer is cleared and no REL message is sent.</p> <p>A value other than 0 must be entered in order to activate the timer.</p> <p>The default value is 0.</p>

**Datafill example**

The following example shows sample datafill for table C7UPTMR signaling protocol AISUP.

**MAP display example for table C7UPTMR signaling protocol AISUP**

```

TMRKEY      C7UPDIR      TMRS
OPTIONS
-----
2W AISUPTM      2W      AISUP
6 90 25 13 180 5 13 13 15 315 45 600 45 600 315 45 600 (MCD
600) $

```

## C7UPTMR signaling protocol ATUP

---

### Australian telephone user part

Signaling protocol ATUP is used for the Australian telephone user part for DMS-100 and DMS-300 switches.

### Datafill

The following table lists the datafill for table C7UPTMR signaling protocol ATUP.

#### Field descriptions

Field	Subfield or refinement	Entry	Explanation and action
	PROT	see subfields	<i>Protocol</i> If the entry in field C7UPDIR is 2W, this subfield consists of subfield BWPROT described in section "C7UPDIR = 2W".  If the entry in field C7UPDIR is IC, this subfield consists of subfield ICPROT described in section "C7UPDIR = IC".  If the entry in field C7UPDIR is OG, this subfield consists of subfield OGPROT described in section "C7UPDIR = OG".

---

**C7UPTMR signaling protocol ATUP** (continued)

---

**C7UPDIR = 2W**

If the entry subfield C7UPDIR is 2W, datafill subfield BWPROT and refinements as described below, and then datafill field OPTIONS.

**Field descriptions for conditional datafill (Sheet 1 of 9)**

Field	Subfield or refinement	Entry	Explanation and action
	BWPROT	ATUP	<i>Two-way protocol</i> Enter ATUP to indicate that the timers are used for the Australian telephone user part for DMS-100 and DMS-300 switches.
	ACMBSM	1 to 45	<i>Address complete or backward setup signal timer</i> Enter the time, in seconds, to wait for the receipt of an address complete message (ACM) or backward setup message (BSM) after sending the last forward address message.  For a DMS-100, the valid range is 1 to 30. For a DMS-300, the valid range is 1 to 45.  Any entry outside the range indicated for this field is invalid.  The timer is only started if the mixed signaling bit is not set in the initial address message (IAM) or IAM with additional information (IAI). It stops when a mixed signaling case message is received, and is reset at the sending of each forward address message.
	ACMBSM (continued)	1 to 45	When the timer expires, the call is taken down and a call failure signal is used to take down the call in the backward direction.  The default value is 15 (15 s).  <b>Note:</b> For DMS-300 switches, a value of 25 must be used.



## C7UPTMR signaling protocol ATUP (continued)

### Field descriptions for conditional datafill (Sheet 2 of 9)

Field	Subfield or refinement	Entry	Explanation and action
	UBMCLF	4 to 15	<p><i>Unsuccessful backward message to clear forward signal timer</i></p> <p>Enter the time, in seconds, to wait for a clear forward (CLF) signal after sending an unsuccessful backward message.</p> <p>This timer starts when an unsuccessful backward message is sent and stops when a CLF signal is received.</p> <p>When the timer expires, a call failure (CFL) signal is sent and the UBMCLF timer is restarted.</p> <p>The default value is 10 (10 s).</p>
	UBMCLF2	60 to 120	<p><i>Unsuccessful backward message to clear forward secondary signal timer</i></p> <p>This is a secondary timer. Enter the time, in multiples of 10 s, to wait for a clear forward signal, after sending an unsuccessful backward message. Timers UBMCLF2 and UBMCLF start at the same time.</p> <p>When timer UBMCLF2 expires, timer UBMCLF stops, a reset circuit (RSC) signal is sent, and timer RSCRESP2 starts.</p> <p>Any entry outside the range indicated for this field is invalid.</p> <p>The default value is 90 (90 s).</p>
	CFLCLF	4 to 15	<p><i>Call failure to clear forward signal timer</i></p> <p>Enter the time, in seconds, to wait for a CLF signal, after sending a CFL signal.</p> <p>This timer starts when a CFL signal is sent and stops when a CLF signal is received.</p> <p>When the timer expires, a CFL signal is sent and timer CFLCLF restarts.</p> <p>The default value is 10 (10 s).</p> <p><b>Note:</b> If timer UBMCLF timer has started, this timer does not start.</p>

## C7UPTMR signaling protocol ATUP (continued)

### Field descriptions for conditional datafill (Sheet 3 of 9)

Field	Subfield or refinement	Entry	Explanation and action
	CFLCLF2	60 to 120	<p><i>Call failure to clear forward secondary signal timer</i> Any entry outside the range indicated for this field is invalid.</p> <p>This is a secondary timer. Enter the time, in multiples of 10 s, to wait for a CLF signal after sending a CFL signal. Timers CFLCLF and CFLCLF2 start at the same time.</p> <p>When timer CFLCLF2 expires, timer CFLCLF stops, an RSC signal is sent, and timer RSCRESP2 starts.</p> <p>The default value is 90 (90 s).</p>
	CLFRLG	4 to 15	<p><i>Clear forward to release guard signal timer</i> Enter the time, in seconds, to wait for a release guard signal after sending a CLF signal.</p> <p>This timer starts when a CLF signal is sent and stops when a release guard signal is received.</p> <p>When the timer expires, a CLF signal is sent and the CLFRLG timer is restarted.</p> <p>The default value is 10 (10 s).</p>
	CLFRLG2	60 to 120	<p><i>Clear forward to release guard secondary signal timer</i> Any entry outside the range indicated for this field is invalid.</p> <p>This is a secondary timer. Enter the time, in multiples of 10 s, to wait for a release guard signal after sending a CLF signal.</p> <p>This timer starts in parallel with the CLFRLG timer.</p> <p>When the timer expires, the CLFRLG timer is stopped, the reset circuit signal is sent, and the RSCRESP2 timer starts.</p> <p>The default value is 90 (90 s).</p>

## C7UPTMR signaling protocol ATUP (continued)

### Field descriptions for conditional datafill (Sheet 4 of 9)

Field	Subfield or refinement	Entry	Explanation and action
	RSCRESP	4 to 15	<p><i>Reset circuit response timer</i> Enter the time, in seconds, to wait for a response to the reset circuit (RSC) signal after sending the RSC signal. The type of acknowledgement received depends on initial conditions. This ensures that circuits are reset to idle after a fault occurs.</p> <p>This timer starts when the RSC signal is sent and stops when an acknowledgement for this signal is received.</p> <p>When the timer expires, the RSC signal is sent and timer RSCRESP restarts.</p> <p>The default value is 10 (10 s).</p>
	RSCRESP2	60 to 120	<p><i>Reset circuit response secondary timer</i> This is a secondary timer.</p> <p>Enter the time, in multiples of 10 s, to wait for a response to the RSC signal after sending the RSC signal. The type of acknowledgement received depends on initial conditions.</p> <p>Timers RSCRESP2 and RSCRESP start at the same time.</p> <p>When timer RSCRESP2 expires, timer RSCRESP stops, the RSC signal is sent, and timer RSCRESP2 restarts.</p> <p>Any entry outside the range indicated for this field is invalid.</p> <p>The default value is 90 (90 s).</p>
	ANSWER	60 to 240	<p><i>Answer timer</i> See descriptions that follow.</p>

## C7UPTMR signaling protocol ATUP (continued)

### Field descriptions for conditional datafill (Sheet 5 of 9)

Field	Subfield or refinement	Entry	Explanation and action
			<p>For a DMS-100 switch</p> <p>When this timer is active on an outgoing trunk, enter the time, in multiples of 10 s, to wait for an ANS signal after receiving an ACM signal.</p> <p>This timer starts when an ACM signal is received and stops when an ANS signal is received. It is activated for originating offices only.</p> <p>When the timer expires, a CLF signal is sent.</p> <p>Any entry outside the range indicated for this field is invalid.</p> <p>The default value is 90 (90 s).</p>
	ANSWER (continued)		<p>For a DMS-300 switch</p> <p>When this timer is active on an incoming trunk, enter the time, in multiples of 10 s, between sending an ACM signal and sending an ANS signal.</p> <p>This timer starts when an ACM signal is sent and stops when an ANS signal is sent.</p> <p>When the timer expires, the call is taken down as follows:</p> <ul style="list-style-type: none"> <li>• For a call outgoing to the international network, a CLF signal is sent forward and the incoming trunk is routed to an announcement.</li> <li>• For a call incoming from the international network, a CLF signal is sent forward, but no backward messages are sent. The originating country takes care of releasing the international circuits.</li> </ul> <p>Any entry outside the range indicated for this field is invalid.</p> <p>The default value is 180 (180 s).</p> <p><b>Note:</b> For DMS-300 switches, a value of 180 must be used.</p>

## C7UPTMR signaling protocol ATUP (continued)

### Field descriptions for conditional datafill (Sheet 6 of 9)

Field	Subfield or refinement	Entry	Explanation and action
	CBKCLF	40 to 200	<p><i>Clear back to clear forward signal timer</i> Enter the time, in multiples of 10 s, to wait for a CLF signal after sending a clear back (CBK) signal.</p> <p>This timer starts when a CBK signal is sent and stops when a CLF or reanswer (RAN) signal is received.</p> <p>When the timer expires, the call is taken down in the forward direction by sending a CLF signal.</p> <p>For a DMS-100 switch, a force release (FRL) signal is sent and either the CLFRLG or FRLCLF timers are started.</p> <p>For a DMS-300 switch, the call is not taken down in the backward direction.</p> <p>The default value is 120 (120 s).</p> <p>Any entry outside the range indicated for this field is invalid.</p> <p><b>Note:</b> For DMS-300 switches, a value of 90 must be used.</p>
	REANSWER	30 to 180	<p><i>Reanswer timer</i> Enter the time, in multiples of 10 s, to wait for the receipt of an RAN, RSC, or FRL signal, or the sending of a CLF signal, after receiving a CBK signal. The RAN and CBK signals are not propagated backwards at the charging point for the DMS-100 switch. Although this timer is datafillable for the DMS-300 switch, there is currently no requirement for it.</p> <p>This timer starts when a CBK signal is received and stops on receipt of a RAN, RSC, or FRL signal, or the sending of a CLF signal.</p> <p>When the timer expires, the call is taken down. The FRL signal is used to take the call down in the backward direction.</p> <p>The default value is 90 (90 s).</p>

## C7UPTMR signaling protocol ATUP (continued)

### Field descriptions for conditional datafill (Sheet 7 of 9)

Field	Subfield or refinement	Entry	Explanation and action
	IDGTBFR	4 to 21	<p><i>Interdigit timer before receipt of minimum number of digits</i></p> <p>Enter the time allowed, in seconds, between the last digit received and the next digit received, before the minimum number of digits required for routing have been received.</p> <p>This timer starts when an IAM or IAI is received, or when each subsequent address message (SAM) or SAM with one signal (SAO) is received, before the minimum number of digits required for routing have been received, and stops when the next address message is received.</p> <p>When the timer expires, the call is taken down.</p> <p>Any entry outside the range indicated for this field is invalid.</p> <p>The default value is 5 (5 s).</p> <p><b>Note:</b> For DMS-300 switches, a value of 16 must be used.</p>
	IDGTAFT	4 to 6	<p><i>Interdigit timer after receipt of minimum number of digits</i></p> <p>Enter the time allowed, in seconds, between the last digit received and receiving the next digit, after the minimum number of digits required for routing have been received.</p> <p>This timer starts on the reception of an IAM or IAI or on each SAM or SAO, after the minimum number of digits required for routing have been received, and stops when the next address message is received.</p> <p>When the timer expires, this indicates the end of dialing.</p> <p>The default value is 5 (5 s).</p>

**C7UPTMR signaling protocol ATUP** (continued)

## Field descriptions for conditional datafill (Sheet 8 of 9)

Field	Subfield or refinement	Entry	Explanation and action
	OGSETUP	40 to 120	<p><i>Overall call setup on outgoing trunk</i> Enter the time, in multiples of 10 s, to wait for an ACM after sending an IAM.</p> <p>This timer starts when the IAM or IAI is sent and stops when an ACM is received.</p> <p>When the timer expires, the call is taken down. The CFL signal is used to take down the call in the backward direction.</p> <p>The default value is 90 (90 s).</p>
	FRLCLF	4 to 15	<p><i>Force release to clear forward signal timer</i> Enter the time, in seconds, to wait for a CLF signal after sending a FRL signal.</p> <p>This timer starts when an FRL signal is sent and stops when a CLF signal is received.</p> <p>When the timer expires, an FRL signal is sent and the timer FRLCLF restarts.</p> <p>The default value is 10 (10 s).</p>
	FRLCLF2	60 to 120	<p><i>Force release to clear forward secondary signal timer</i> This is a secondary timer. Enter the time, in multiples of 10 s, to wait for a CLF signal after sending an FRL signal.</p> <p>Timers FRLCLF2 and FRLCLF start at the same time.</p> <p>When timer FRLCLF2 expires, timer FRLCLF timer stops, the RSC signal is sent, and timer RSCRESP2 starts.</p> <p>The default value is 90 (90 s).</p>
OPTIONS (BCS36-)		See subfields	<p><i>Timer options list</i> Enter OPTION and datafill its subfields.</p>

---

**C7UPTMR signaling protocol ATUP** (continued)

---

**Field descriptions for conditional datafill (Sheet 9 of 9)**

Field	Subfield or refinement	Entry	Explanation and action
	OPTION	MCD	<p><i>Option</i> Enter MCD for Minimum Call Duration and datafill subfield MCD_TIMER.</p> <p>Enter \$ if no refinements have been defined.</p>
	MCD_TIMER	0 to 700	<p>Enter the time, in 10 ms units, between receiving an answer (ANS) message and sending a release message (REL).</p> <p>The MCD timer starts after an ANS message is received and stops after a REL message is sent.</p> <p>If a clear back (CBK) message is received while the MCD timer is active, a disconnect time is set and a REL message is sent when the timer expires.</p> <p>If a reanswer (RAN) message is received before the MCD timer expires, the timer will be cleared and a REL message will not be sent.</p> <p>A value other than 0 must be entered in order to activate the timer.</p> <p>The default value is 0.</p>



## C7UPTMR signaling protocol ATUP (continued)

### C7UPDIR = IC

If the entry in subfield C7UPDIR is IC, datafill subfield ICPROT and refinements as described below, and then datafill field OPTIONS as described on page.

#### Field descriptions for conditional datafill (Sheet 1 of 7)

Field	Subfield or refinement	Entry	Explanation and action
	ICPROT	ATUP	<i>Incoming protocol</i> Enter ATUP to indicate that the timers are used for the Australian telephone user part for DMS-100 and DMS-300 switches.
	UBMCLF	4 to 15	<i>Unsuccessful backward message to clear forward signal timer</i> Enter the time, in seconds, to wait for a clear forward (CLF) signal, after sending an unsuccessful backward message.  This timer starts when an unsuccessful backward message is sent and stops when a CLF signal is received.  When the timer expires, a call failure (CFL) signal is sent, and the UBMCLF timer is restarted.  The default value is 10 (10 s).
	UBMCLF2	60 to 120	<i>Unsuccessful backward message to clear forward secondary signal timer</i> This is a secondary timer.  Enter the time, in multiples of 10 s, to wait for a clear forward signal, after sending an unsuccessful backward message.  Timers UBMCLF2 and UBMCLF start at the same time.  If timer UBMCLF2 expires, timer UBMCLF stops, a reset circuit (RSC) signal is sent, and timer RSCRESP2 starts.  Any entry outside the range indicated for this field is invalid.  The default value is 90 (90 s).

## C7UPTMR signaling protocol ATUP (continued)

### Field descriptions for conditional datafill (Sheet 2 of 7)

Field	Subfield or refinement	Entry	Explanation and action
	CFLCLF	4 to 15	<p><i>Call failure to clear forward signal timer</i> Enter the time, in seconds, to wait for a CLF signal, after sending a CFL signal.</p> <p>This timer starts when a CFL signal is sent and stops when a CLF signal is received.</p> <p>When the timer expires, a CFL signal is sent, and timer CFLCLF restarts.</p> <p>The default value is 10 (10 s).</p> <p><b>Note:</b> If timer UBMCLF timer has started, this timer does not start.</p>
	CFLCLF2	60 to 120	<p><i>Call failure to clear forward secondary signal timer</i> This is a secondary timer. Enter the time, in multiples of 10 s, to wait for a CLF signal after sending a CFL signal. Timers CFLCLF and CFLCLF2 start at the same time.</p> <p>When timer CFLCLF2 expires, timer CFLCLF stops, an RSC signal is sent, and timer RSCRESP2 starts.</p> <p>Any entry outside the range indicated for this field is invalid.</p> <p>The default value is 90 (90 s).</p>
	RSCRESP	4 to 15	<p><i>Reset circuit response timer</i> Enter the time, in seconds, to wait for a response to the RSC signal after sending the an RSC signal. The type of acknowledgement received depends on initial conditions. This ensures that circuits are reset to idle after a fault occurs.</p> <p>This timer starts when the RSC signal is sent and stops when an acknowledgement for this signal is received.</p> <p>When the timer expires, the RSC signal is sent and timer RSCRESP restarts.</p> <p>The default value is 10 (10 s).</p>

## C7UPTMR signaling protocol ATUP (continued)

### Field descriptions for conditional datafill (Sheet 3 of 7)

Field	Subfield or refinement	Entry	Explanation and action
	RSCRESP2	60 to 120	<p><i>Reset circuit response secondary timer</i> This is a secondary timer.</p> <p>Enter the time, in multiples of 10 s, to wait for a response to the RSC signal after sending the RSC signal. The type of acknowledgement received depends on initial conditions.</p> <p>Timers RCSRESP2 and RCSRESP start at the same time.</p> <p>When timer RSCRESP2 expires, timer RSCRESP stops, the RSC signal is sent, and timer RSCRESP2 restarts.</p> <p>Any entry outside the range indicated for this field is invalid.</p> <p>The default value is 90 (90 s).</p>
	ANSWER	60 to 240	<p><i>Answer timer</i> See descriptions that follow.</p> <p>For a DMS-100 switch</p> <p>When this timer is active on an outgoing trunk, enter the time, in multiples of 10 s, to wait for an answer (ANS) signal, after receiving an address complete signal.</p> <p>This timer starts when an address complete signal is received and stops when an ANS signal is received. It is activated for originating offices only.</p> <p>When the timer expires, a CLF signal is sent.</p> <p>Any entry outside the range indicated for this field is invalid.</p> <p>The default value is 90 (90 s).</p>

---

**C7UPTMR signaling protocol ATUP** (continued)

---

**Field descriptions for conditional datafill (Sheet 4 of 7)**

Field	Subfield or refinement	Entry	Explanation and action
			<p>For a DMS-300 switch</p> <p>When active on an incoming trunk, enter the time, in multiples of 10 s, between sending an address complete signal and sending an ANS signal.</p> <p>This timer starts when an address complete signal is sent and stops when an ANS signal is sent.</p> <p>When the timer expires, the call is taken down as follows:</p> <ul style="list-style-type: none"> <li>• For a call outgoing to the international network, a CLF signal is sent forward and the incoming trunk is routed to an announcement.</li> <li>• For a call incoming from the International network, a CLF is sent forward, but no backward messages are sent. The originating country takes care of releasing the international circuits.</li> </ul> <p>Any entry outside the range indicated for this field is invalid.</p> <p>The default value is 180 (180 s).</p> <p><b>Note:</b> For DMS-300 switches, a value of 180 must be used.</p>

## C7UPTMR signaling protocol ATUP (continued)

### Field descriptions for conditional datafill (Sheet 5 of 7)

Field	Subfield or refinement	Entry	Explanation and action
	CBKCLF	40 to 200	<p><i>Clear back to clear forward signal timer</i> Enter the time, in multiples of 10 s, to wait for a CLF signal after sending a clear back (CBK) signal.</p> <p>This timer starts when a CBK signal is sent and stops when a CLF or reanswer (RAN) signal is received.</p> <p>When the timer expires, the call is taken down in the forward direction by sending a CLF signal.</p> <p>For a DMS-300 switch, the call is not taken down in the backward direction.</p> <p>For a DMS-100 switch, a force release (FRL) signal is sent and either the CLFRLG or FRLCLF timers are started.</p> <p>Any entry outside the range indicated for this field is invalid.</p> <p>The default value is 120 (120 s).</p> <p><b>Note:</b> For DMS-300 switches, a value of 90 must be used.</p>

## C7UPTMR signaling protocol ATUP (continued)

### Field descriptions for conditional datafill (Sheet 6 of 7)

Field	Subfield or refinement	Entry	Explanation and action
	IDGTBFR	4 to 21	<p><i>Interdigit timer before receipt of minimum number of digits</i></p> <p>Enter the time allowed, in seconds, between the last digit received and the next digit received, before the minimum number of digits required for routing were received.</p> <p>This timer starts when an initial address message (IAM) or IAM with additional information (IAI) is received or when each subsequent address message (SAM) or SAM with one signal (SAO) is received, before the minimum number of digits required for routing were received, and stops when the next address message is received.</p> <p>When the timer expires, the call is taken down.</p> <p>Any entry outside the range indicated for this field is invalid.</p> <p>The default value is 5 (5 s).</p> <p><b>Note:</b> For DMS-300 switches a value of 16 must be used.</p>
	IDGTAFT	4 to 6	<p><i>Interdigit timer after receipt of minimum number of digits</i></p> <p>Enter the time allowed, in seconds, between the last digit received and receiving the next digit, after the minimum number of digits required for routing were received.</p> <p>This timer starts on the reception of an IAM or IAI or on each SAM or SAO, after the minimum number of digits required for routing were received, and stops when the next address message is received.</p> <p>When the timer expires, this indicates the end of dialing.</p> <p>The default value is 5 (5 s).</p>

## C7UPTMR signaling protocol ATUP (continued)

### Field descriptions for conditional datafill (Sheet 7 of 7)

Field	Subfield or refinement	Entry	Explanation and action
	FRLCLF	4 to 15	<p><i>Force release to clear forward signal timer</i> Enter the time, in seconds, to wait for a CLF signal after sending a FRL signal.</p> <p>This timer starts when an FRL signal is sent and stops when a CLF signal is received.</p> <p>When the timer expires, an FRL signal is sent and the timer FRLCLF restarts.</p> <p>The default value is 10 (10 s).</p>
	FRLCLF2	60 to 120	<p><i>Force release to clear forward secondary signal timer</i> This is a secondary timer. Enter the time, in multiples of 10 s, to wait for a CLF signal after sending an FRL signal.</p> <p>Timers FRLCLF2 and FRLCLF start at the same time.</p> <p>When timer FRLCLF2 expires, timer FRLCLF timer stops, the RSC signal is sent, and timer RSCRESP2 starts.</p> <p>The default value is 90 (90 s).</p>
OPTIONS (BCS36-)		\$	<p><i>Timer options list</i> No refinements defined. Enter \$.</p>

## C7UPTMR signaling protocol ATUP (continued)

### C7UPDIR = OG

If the entry subfield C7UPDIR is OG, datafill subfield OGPROT and refinements as described below, and then datafill field OPTIONS.

#### Field descriptions for conditional datafill (Sheet 1 of 6)

Field	Subfield or refinement	Entry	Explanation and action
	OGPROT	ATUP	<p><i>Outgoing protocol</i> Enter ATUP to indicate that the timers are used for the Australian telephone user part for DMS-100 and DMS-300 switches.</p>
	ACMBSM	1 to 45	<p><i>Address complete or backward setup signal timer</i> Enter the time, in seconds, to wait for the receipt of an address complete message (ACM) or backward setup message (BSM) after sending the last forward address message.</p> <p>The timer is only started if the mixed signaling bit is not set in the initial address message (IAM) or IAM with additional information (IAI). It stops when a mixed signaling case message is received, and is reset at the sending of each forward address message.</p> <p>When the timer expires, the call is taken down and a call-failure (CFL) signal is used to take down the call in the backward direction.</p> <p>The default value is 15 (15 s).</p> <p><b>Note:</b> For DMS-300 switches, a value of 25 must be used.</p>
	CLFRLG	4 to 15	<p><i>Clear forward to release guard signal timer</i> Enter the time, in seconds, to wait for a release guard signal after sending a clear forward (CLF) signal.</p> <p>This timer starts when a CLF signal is sent and stops when a release guard signal is received.</p> <p>When the timer expires, a CLF signal is sent and the CLFRLG timer restarts.</p> <p>The default value is 10 (10 s).</p>



## C7UPTMR signaling protocol ATUP (continued)

### Field descriptions for conditional datafill (Sheet 2 of 6)

Field	Subfield or refinement	Entry	Explanation and action
	CLFRLG2	60 to 120	<p><i>Clear forward to release guard secondary signal timer</i></p> <p>This is a secondary timer. Enter the time, in multiples of 10 s, to wait for a release guard signal after sending a CLF signal.</p> <p>This timer starts in parallel with the CLFRLG timer. When the timer expires, the CLFRLG timer stops, the reset circuit (RSC) signal is sent, and the RSCRESP2 timer starts.</p> <p>Any entry outside the range indicated for this field is invalid.</p> <p>The default value is 90 (90 s).</p>
	RSCRESP	4 to 15	<p><i>Reset circuit response timer</i></p> <p>Enter the time, in seconds, to wait for a response to the RSC signal after sending the an RSC signal. The type of acknowledgement received depends on initial conditions. This ensures that circuits are reset to idle after a fault occurs.</p> <p>This timer starts when the RSC signal is sent and stops when an acknowledgement for this signal is received.</p> <p>When the timer expires, the RSC signal is sent and timer RSCRESP restarts.</p> <p>The default value is 10 (10 s).</p>

## C7UPTMR signaling protocol ATUP (continued)

### Field descriptions for conditional datafill (Sheet 3 of 6)

Field	Subfield or refinement	Entry	Explanation and action
	RSCRESP2	60 to 120	<p><i>Reset circuit response secondary timer</i> This is a secondary timer.</p> <p>Enter the time, in multiples of 10 s, to wait for a response to the RSC signal after sending the RSC signal. The type of acknowledgement received depends on initial conditions.</p> <p>Timers RCSRESP2 and RCSRESP start at the same time.</p> <p>When timer RSCRESP2 expires, timer RSCRESP stops, the RSC signal is sent, and timer RSCRESP2 restarts.</p> <p>Any entry outside the range indicated for this field is invalid.</p> <p>The default value is 90 (90 s).</p>
	ANSWER	60 to 240	<p><i>Answer timer</i> See descriptions that follow.</p> <p>For a DMS-100 switch:</p> <p>When this timer is active on an outgoing trunk, enter the time, in multiples of 10 s, to wait for an answer (ANS) signal, after receiving an ACM signal.</p> <p>This timer starts when an ACM signal is received and stops when an ANS signal is received. It is activated for originating offices only.</p> <p>When the timer expires, a CLF signal is sent.</p> <p>Any entry outside the range indicated for this field is invalid.</p> <p>The default value is 90 (90 s).</p>

## C7UPTMR signaling protocol ATUP (continued)

### Field descriptions for conditional datafill (Sheet 4 of 6)

Field	Subfield or refinement	Entry	Explanation and action
	ANSWER (continued)		<p>For a DMS-300 switch:</p> <p>Any entry outside the range indicated for this field is invalid.</p> <p>When active on an incoming trunk, enter the time, in multiples of 10 s, between sending an ACM signal and sending an ANS signal.</p> <p>This timer starts when an ACM signal is sent and stops when an ANS signal is sent.</p> <p>When the timer expires, the call is taken down as follows:</p> <ul style="list-style-type: none"> <li>• For a call outgoing to the international network, a CLF signal is sent forward and the incoming trunk is routed to an announcement.</li> <li>• For a call incoming from the international network, a CLF signal is sent forward, but no backward messages are sent. The originating country takes care of releasing the international circuits.</li> </ul> <p>The default value is 180 (180 s).</p> <p><b>Note:</b> For DMS-300 switches, a value of 180 must be used.</p>

## C7UPTMR signaling protocol ATUP (continued)

### Field descriptions for conditional datafill (Sheet 5 of 6)

Field	Subfield or refinement	Entry	Explanation and action
	REANSWER	30 to 180	<p><i>Reanswer timer</i> Enter the time, in multiples of 10 s, to wait for the receipt of a reanswer (RAN), RSC, or force release (FRL) signal, or the sending of a CLF signal, after receiving a clear back (CBK) signal. The RAN and CBK signals are not propagated backwards at the charging point for the DMS-100 switch. Although this timer is datafillable for the DMS-300 switch, there is currently no requirement for it.</p> <p>This timer starts when a CBK signal is received and stops on receipt of a RAN, RSC, or FRL signal, or the sending of a CLF signal.</p> <p>When the timer expires, the call is taken down. The FRL signal is used to take the call down in the backward direction.</p> <p>The default value is 90 (90 s).</p>
	OGSETUP	40 to 120	<p><i>Overall call setup on outgoing trunk</i> Enter the time, in multiples of 10 s, to wait for an ACM message after sending an IAM or IAI.</p> <p>This timer starts when the initial address message is sent and stops when an ACM is received.</p> <p>When the timer expires, the call is taken down. The CFL signal is used for take down in the backward direction.</p> <p>The default value is 90 (90 s).</p>
OPTIONS (BCS36-)		See subfields	<p><i>Timer options list</i> Enter OPTION and datafill its subfields.</p>

## C7UPTMR signaling protocol ATUP (end)

### Field descriptions for conditional datafill (Sheet 6 of 6)

Field	Subfield or refinement	Entry	Explanation and action
	OPTION	MCD	<p><i>Option</i> Enter MCD for Minimum Call Duration and datafill subfield MCD_TIMER.</p> <p>Enter \$ if no refinements have been defined.</p>
	MCD_TIMER	0 to 700	<p>Enter the time, in 10 ms units, between receiving an answer (ANS) message and sending a release message (REL).</p> <p>The MCD timer starts after an ANS message is received and stops after a REL message is sent.</p> <p>If a clear back (CBK) message is received while the MCD timer is active, a disconnect time is set and a REL message is sent when the timer expires.</p> <p>If a reanswer (RAN) message is received before the MCD timer expires, the timer will be cleared and a REL message will not be sent.</p> <p>A value other than 0 must be entered in order to activate the timer.</p> <p>The default value is 0.</p>

### Datafill example

The following example shows sample datafill for table C7UPTMR signaling protocol ATUP.

### MAP display example for table C7UPTMR signaling protocol ATUP

TMRKEY	C7UPDIR	TMRS																
OPTIONS																		
-----																		
2WATUPTM	2W	ATUP																
16	10	90	10	90	6	60	10	60	90	120	90	10	6	90	10	90		
(MCD 600) \$																		

---

## C7UPTMR signaling protocol BTUP

---

### United Kingdom variant of national user part

Signaling protocol BTUP is used for the United Kingdom (UK) variant of national user part.

### Datafill

The following table lists the datafill for table C7UPTMR signaling protocol BTUP.

### Field descriptions

Field	Subfield or refinement	Entry	Explanation and action
	PROT	see subfields	<p><i>Protocol</i></p> <p>If the entry in field C7UPDIR is 2W, this subfield consists of subfield BWPROT described in section "C7UPDIR = 2W".</p> <p>If the entry in field C7UPDIR is IC, this subfield consists of subfield ICPROT described in section "C7UPDIR = IC".</p> <p>If the entry in field C7UPDIR is OG, this subfield consists of subfield OGPROT described in section "C7UPDIR = OG".</p>

### C7UPDIR = 2W

If the entry subfield C7UPDIR is 2W, datafill subfield BWPROT and refinements as described below.

**Note:** Timers BTUPT<sub>n</sub> (n = 1, 2, 3, 4, 5) cannot be displayed if the EXT (external) file BTUPGWSB is used to datafill this table. This is normally the case on the integrated services switching unit (DMS-300). These fields do not appear if any display command, such as RANGE and CHANGE, is requested at the MAP (maintenance and administration position) within the table editor.

## C7UPTMR signaling protocol BTUP (continued)

### Field descriptions for conditional datafill (Sheet 1 of 8)

Field	Subfield or refinement	Entry	Explanation and action
	BWPROT	BTUP	<p><i>Two-way protocol</i> Enter BTUP to indicate that the timers are the United Kingdom (UK) variant of national user part timers.</p>
	BTUPT1	1 to 300	<p><i>Call reanswer timer</i> Enter the time, in seconds, to allow reanswer if the called subscriber releases the line. When the timer expires, a release (REL) message is sent forward and awaits a circuit free message. This timer is run at the originating node.</p> <p>The timer starts when the called subscriber clears and stops when an answer message is received.</p> <p>The default value is 120 (120 s).</p> <p><b>Note:</b> This timer cannot be displayed if the EXT (external) file BTUPGWSB is used to datafill this table.</p>
	BTUPT2	1 to 420	<p><i>Call answer timer</i> Enter the time, in seconds, to wait for the call answer after receiving all digits. This timer is run at the originating node.</p> <p>The timer starts when address complete message (ACM) is received and stops when the call is answered.</p> <p>When the timer expires, the call is released.</p> <p>The default value is 120 (120 s).</p> <p><b>Note:</b> This timer cannot be displayed if the EXT file BTUPGWSB is used to datafill this table.</p>

## C7UPTMR signaling protocol BTUP (continued)

### Field descriptions for conditional datafill (Sheet 2 of 8)

Field	Subfield or refinement	Entry	Explanation and action
	BTUPT3	1 to 300	<p><i>Call reanswer timer</i> Enter the time, in seconds, to wait for reanswer (RAN) signal after the called subscriber releases the line. This timer runs at the terminating node.</p> <p>The timer starts when the called subscriber clears first and stops when a RAN signal or a release forward signal is received.</p> <p>When the timer expires, an REL message is sent back giving a reason and the timer waits for forward release.</p> <p>The default value is 210 (210 s).</p> <p><b>Note:</b> This timer cannot be displayed if the EXT file BTUPGWSB is used to datafill this table.</p>
	BTUPT4	1 to 240	<p><i>Circuit overload timer</i> Enter the time, in seconds, after receiving a circuit overload message before releasing the circuit.</p> <p>The timer starts when an overload signal is received and is not canceled. When the timer expires, the circuit is released.</p> <p>The default value is 90 (90 s).</p>
	BTUPT5	2 to 600	<p><i>Call answer timer</i> Enter the time, in seconds, to wait for call answer after dialing is complete. This timer runs at the terminating node.</p> <p>The timer starts when an address complete message (ACM) is sent and stops when the call is answered. When the timer expires, the call is released.</p> <p>The default value is 180 (180 s).</p> <p><b>Note:</b> This timer cannot be displayed if the EXT file BTUPGWSB is used to datafill this table.</p>



## C7UPTMR signaling protocol BTUP (continued)

### Field descriptions for conditional datafill (Sheet 3 of 8)

Field	Subfield or refinement	Entry	Explanation and action
	BTUPT6	1 to 30	<p><i>Minimum digits timer</i> Enter the time, in seconds, between receiving the minimum number of digits and receiving a subsequent digit.</p> <p>The timer starts when the minimum number of digits have been received and stops when a subsequent digit is received.</p> <p>When the timer expires, the circuit is released.</p> <p>The default value is 4 (4 s).</p>
	BTUPT8	4 to 120	<p><i>Blocking or unblocking acknowledgement message timer</i> Enter the time, in seconds, between the sending of a blocking (BLO) or unblocking (UBL) message and the receipt of a blocking acknowledgement (BLA) or unblocking acknowledgement (UBA) message.</p> <p>The timer starts when a BLO or UBL message is sent and stops when BLA or UBA message is received.</p> <p>When the timer expires and the UBL message was sent three times without acknowledgement, the circuit is returned to idle.</p> <p>The default value is 30 (30 s).</p>
	BTUPT9	1 to 90	<p><i>Address complete message timer</i> Enter the time, in seconds, between sending of the initial address message (IAM) and the receipt of an ACM.</p> <p>The timer starts when IAM is sent and stops when an ACM is received.</p> <p>When the timer expires, the circuit is released and waits for a circuit-free signal.</p> <p>The default value is 20 (20 s).</p>

---

**C7UPTMR signaling protocol BTUP** (continued)
 

---

**Field descriptions for conditional datafill (Sheet 4 of 8)**

Field	Subfield or refinement	Entry	Explanation and action
	BTUPT10	1 to 120	<p><i>Forward release message timer</i> Enter the time, in seconds, to wait for a forward release message after an REL message is sent backwards.</p> <p>The timer starts when an REL message is sent and stops when an REL message is received.</p> <p>When the timer expires and an REL message was sent backwards twice, then it is assumed that release forward was received and the circuit is freed.</p> <p>The default value is 6 (6 s).</p>
	BTUPT12	1 to 60	<p><i>Circuit free message timer</i> Enter the time, in seconds, between the receipt of circuit free message after sending an REL message.</p> <p>The timer starts when an REL message is sent and stops when the circuit free signal is received.</p> <p>When the timer expires, the circuit is released giving a reason.</p> <p>The default value is 6 (6 s).</p>
	BTUPT13	4 to 300	<p><i>Unblocking message timer</i> Enter the time, in seconds, between the receipt of an unblocking (UBL) message after the receipt of a blocking (BLO) message.</p> <p>The timer starts when the BLO signal is received and stops when the UBL signal is received.</p> <p>When the timer expires, the circuit is made busy.</p> <p>The default value is 180 (180 s).</p>

## C7UPTMR signaling protocol BTUP (continued)

### Field descriptions for conditional datafill (Sheet 5 of 8)

Field	Subfield or refinement	Entry	Explanation and action
	BTUPT14	1 to 120	<p><i>Additional information request timer</i> Enter the time, in seconds, between requesting additional information and receiving it.</p> <p>The timer starts when the request for additional information is sent and stops when the information is received.</p> <p>When the timer expires, an REL message is sent back giving a reason and waits for a forward release message.</p> <p>The default value is 30 (30 s).</p>
	BTUPT15	1 to 60	<p><i>Initial or subsequent digit reception timer</i> Enter the time, in seconds, that the circuit waits for the initial or a subsequent digit.</p> <p>The timer starts when a seizure occurs (line goes off-hook) or if a digit is received, and stops when a subsequent digit is received.</p> <p>When the timer expires, the circuit is released.</p> <p>The default value is 20 (20 s).</p>
	BTUPT16	1 to 300	<p><i>Call setup timer</i> Enter the time, in seconds, that the switch is allowed to set up a single call.</p> <p>The timer starts when the calling party goes off-hook and stops when an ACM is received.</p> <p>When the timer expires, the circuit is released.</p> <p>The default value is 120 (120 s).</p>

## C7UPTMR signaling protocol BTUP (continued)

### Field descriptions for conditional datafill (Sheet 6 of 8)

Field	Subfield or refinement	Entry	Explanation and action
	BTUPT17	1 to 60	<p><i>Send-all-digits timer</i> Enter the time, in seconds, between sending a send-all-digits message and receiving a subsequent address message (SAM) or a final address message (FAM).</p> <p>The timer starts after sending a send-all-digits message and stops when a subsequent SAM or FAM is received.</p> <p>When the timer expires, a call failure (CFL) message with reason is sent back and the circuit is released giving a reason.</p> <p>The default value is 20 (20 s).</p>
	BTUPT18	1 to 300	<p><i>Send-n-digits timer</i> Enter the time, in seconds, between sending a send-n-digits message and receiving a subsequent address message (SAM) or a final address message (FAM).</p> <p>The timer starts after sending a send-n-digits message and stops when a subsequent SAM or FAM is received.</p> <p>When the timer expires, a call failure (CFL) message with reason is sent back and the circuit is released giving a reason.</p> <p>The default value is 180 (180 s).</p>
	BTUPT19	1 to 300	<p><i>Holding incoming circuit timer</i> Enter the time, in seconds, that an incoming circuit is held after rejecting the call due to an overload condition.</p> <p>The timer starts when the overload signal is sent and stops when the release signal is received.</p> <p>When the timer expires, a release signal is send back giving a reason.</p> <p>The default value is 180 (180 s).</p>

## C7UPTMR signaling protocol BTUP (continued)

### Field descriptions for conditional datafill (Sheet 7 of 8)

Field	Subfield or refinement	Entry	Explanation and action
	BTUPT20	4 to 600	<p><i>Notification timer</i> Enter the time, in seconds, between the near end trunk being busied and the end office being notified that the near end trunk was not returned to service.</p> <p>The timer starts when blocking is received and stops when unblocking is received.</p> <p>When the timer expires, the end office is notified that the near end trunk was not returned to service.</p> <p>The default value is 180 (180 s).</p>
	Q118_1 (-BCS35)	120 to 240	<p><i>Answer signal timer</i> Enter the time, in seconds, to wait for the answer signal after receiving the ACM.</p> <p>The timer starts when an ACM is received and stops when an answer signal is received.</p> <p>When the timer expires, the connection is released.</p> <p>The default value is 180 (180 s).</p>
	Q118_2 (-BCS35)	60 to 120	<p><i>Release or reanswer signal timer</i> Enter the time, in seconds, to wait for a release from the calling subscriber or a reanswer from the called subscriber after receiving a clear back signal.</p> <p>The timer starts when a clear back signal is received and stops when a release or reanswer signal is received. When the timer expires, the international part of the connection is released and charging for the call is stopped.</p> <p>The default value is 90 (90 s).</p>

---

**C7UPTMR signaling protocol BTUP** (continued)

---

**Field descriptions for conditional datafill (Sheet 8 of 8)**

Field	Subfield or refinement	Entry	Explanation and action
	Q118_3 (-BCS35)	120 to 240	<p><i>Clear forward timer</i> Enter the time, in seconds, to wait for a clear forward signal after sending a clear back signal.</p> <p>The timer starts when a clear back signal is sent and stops when a clear forward signal is received. When the timer expires, the national part of the connection is released.</p> <p>The default value is 150 (150 s).</p>
OPTIONS (BCS36-)		Q33 or \$	<p><i>Timer options list</i> Enter Q33 for the Q33 option and datafill refinement Q33_TIMER. Otherwise, enter \$.</p>
	Q33_TIMER	10 to 30	<p><i>Q33 timer</i> Enter the time, in seconds, for the Q33 timer.</p>

**C7UPDIR = IC**

If the entry in subfield C7UPDIR is IC, datafill subfield ICPROT and refinements as described below.

**Note:** Timers BTUPT3 and BTUPT5 cannot be displayed if the EXT (external) file BTUPGWSB is used to datafill this table. This is normally the case on the DMS-300 integrated services switching unit (ISSU). These fields do not appear if any display command, such as RANGE and CHANGE, is requested at the MAP (maintenance and administration position) within the table editor.

## C7UPTMR signaling protocol BTUP (continued)

### Field descriptions for conditional datafill (Sheet 1 of 5)

Field	Subfield or refinement	Entry	Explanation and action
	ICPROT	BTUP	<i>Incoming protocol</i> Enter BTUP to indicate that the timers are United Kingdom (UK) variant of national telephone user part timers
	BTUPT3	1 to 300	<i>Call reanswer timer</i> Enter the time, in seconds, to wait for reanswer (RAN) signal after the called subscriber releases the line. This timer runs at the terminating node.  The timer starts when the called subscriber clears first and stops when a RAN signal or a release forward signal is received.  When the timer expires, a release signal is sent back giving a reason and the timer waits for a forward release signal. The default value is 210 (210 s).  <b>Note:</b> This timer cannot be displayed if the EXT (external) file BTUPGWSB is used to datafill this table.
	BTUPT5	2 to 600	<i>Call answer timer</i> Enter the time, in seconds, to wait for call answer after dialing is complete. This timer runs at the terminating node.  The timer starts when an address complete message (ACM) is sent and stops when the call is answered. When the timer expires, the call is released.  The default value is 180 (180 s).  <b>Note:</b> This timer cannot be displayed if the EXT file BTUPGWSB is used to datafill this table.

## C7UPTMR signaling protocol BTUP (continued)

### Field descriptions for conditional datafill (Sheet 2 of 5)

Field	Subfield or refinement	Entry	Explanation and action
	BTUPT6	1 to 30	<p><i>Minimum digits timer</i> Enter the time allowed, in seconds, between receiving the minimum number of digits and receiving a subsequent digit.</p> <p>The timer starts when the minimum number of digits were received and stops when a subsequent digit is received.</p> <p>When the timer expires, the circuit is released.</p> <p>The default value is 4 (4 s).</p>
	BTUPT8	4 to 120	<p><i>Blocking or unblocking acknowledgement message timer</i> Enter the time allowed, in seconds, between the sending of a blocking (BLO) or unblocking (UBL) message and receiving a blocking acknowledgement (BLA) or an unblocking acknowledgement (UBA) message.</p> <p>The timer starts when a BLO or UBL message is sent and stops when a BLA or UBA message is received.</p> <p>When the timer expires and UBL was sent three times without acknowledgement, the circuit is returned to idle.</p> <p>The default value is 30 (30 s).</p>
	BTUPT10	1 to 120	<p><i>Forward release message timer</i> Enter the time, in seconds, to wait for a forward release message after a release (REL) message is sent backwards.</p> <p>The timer starts when an REL message is sent backwards, and stops when an REL message is received.</p> <p>When the timer expires and release was sent backwards twice, then it is assumed that a release forward message was received and the circuit is freed.</p> <p>The default value is 6 (6 s).</p>



## C7UPTMR signaling protocol BTUP (continued)

### Field descriptions for conditional datafill (Sheet 3 of 5)

Field	Subfield or refinement	Entry	Explanation and action
	BTUPT12	1 to 60	<p><i>Circuit-free message timer</i> Enter the time allowed, in seconds, between sending an REL message and receiving a circuit-free message.</p> <p>The timer starts when an REL message is sent and stops when the circuit-free signal is received.</p> <p>When the timer expires, the circuit is released giving a reason.</p> <p>The default value is 6 (6 s).</p>
	BTUPT14	1 to 120	<p><i>Additional information request timer</i> Enter the time allowed, in seconds, between requesting additional information and receiving it.</p> <p>The timer starts when a request for additional information is sent and stops when the information is received.</p> <p>When the timer expires, an REL message is sent back giving a reason and waits for a forward release message.</p> <p>The default value is 30 (30 s).</p>
	BTUPT15	1 to 60	<p><i>Initial or subsequent digit reception timer</i> Enter the time, in seconds, that the circuit waits for the initial or a subsequent digit.</p> <p>The timer starts when a seizure occurs (line goes off-hook) or when a digit is received, and stops when a subsequent digit is received.</p> <p>When the timer expires, the circuit is released.</p> <p>The default value is 20 (20 s).</p>

## C7UPTMR signaling protocol BTUP (continued)

### Field descriptions for conditional datafill (Sheet 4 of 5)

Field	Subfield or refinement	Entry	Explanation and action
	BTUPT17	1 to 60	<p><i>Send-all-digits timer</i> Enter the time allowed, in seconds, between sending a send-all-digits message and receiving a subsequent address message (SAM) or a final address message (FAM).</p> <p>The timer starts after sending a send-all-digits message and stops when a SAM or FAM is received.</p> <p>When the timer expires, call failure (CFL) message with reason is sent back and the circuit is released giving a reason.</p> <p>The default value is 20 (20 s).</p>
	BTUPT18	1 to 300	<p><i>Send-n-digits timer</i> Enter the time allowed, in seconds, between sending a send-n-digits message and receiving a SAM or a FAM.</p> <p>The timer starts after sending a send-n-digits message and stops when a subsequent SAM or FAM is received.</p> <p>When the timer expires, a CFL with reason is sent back and the circuit is released giving a reason.</p> <p>The default value is 180 (180 s).</p>
	BTUPT19	1 to 300	<p><i>Holding incoming circuit timer</i> Enter the time, in seconds, that an incoming circuit is held after rejecting the call due to an overload condition.</p> <p>The timer starts when the overload signal is sent and stops when the release signal is received.</p> <p>When the timer expires, a release signal is send back giving a reason.</p> <p>The default value is 180 (180 s).</p>

## C7UPTMR signaling protocol BTUP (continued)

### Field descriptions for conditional datafill (Sheet 5 of 5)

Field	Subfield or refinement	Entry	Explanation and action
	BTUPT20	4 to 600	<p><i>Notification timer</i> Enter the time allowed, in seconds, between the near-end trunk being busied, and the end office being notified that the near-end trunk was not returned to service.</p> <p>The timer starts when blocking is received and stops when unblocking is received.</p> <p>When the timer expires, the end office is notified that the near-end trunk was not returned to service.</p> <p>The default value is 180 (180 s).</p>
	Q118_1 (-BCS35)	120 to 240	<p><i>Answer signal timer</i> Enter the time, in seconds, to wait for the answer signal after receiving the ACM.</p> <p>The timer starts when an ACM is received and stops when an answer signal is received.</p> <p>When the timer expires, the connection is released.</p> <p>The default value is 180 (180 s).</p>
	Q118_2 (-BCS35)	60 to 120	<p><i>Release or reanswer signal timer</i> Enter the time, in seconds, to wait for a release from the calling subscriber or a reanswer from the called subscriber after receiving a clear back signal.</p> <p>The timer starts when a clear back signal is received and stops when a release or reanswer signal is received.</p> <p>When the timer expires, the international part of the connection is released and charging for the call is stopped.</p> <p>The default value is 90 (90 s).</p>
OPTIONS (BCS36-)		Q33 or \$	<p><i>Timer options list</i> Enter Q33 for the Q33 option and datafill refinement Q33_TIMER. Otherwise, enter \$.</p>
	Q33_TIMER	10 to 30	<p><i>Q33 timer</i> Enter the time, in seconds, for the Q33 timer.</p>

---

**C7UPTMR signaling protocol BTUP** (continued)

---

**C7UPDIR = OG**

If the entry subfield C7UPDIR is OG, datafill subfield OGPROT and refinements as described below.

**Note:** The BTUPT1 and BTUPT2 timers cannot be displayed if the EXT (external) file BTUPGWSB is used to datafill this table. This is normally the case on the integrated services switching unit (DMS-300). These fields do not appear if any display command, such as range and change, is requested at the MAP (maintenance and administration position) within the table editor.

**Field descriptions for conditional datafill (Sheet 1 of 4)**

Field	Subfield or refinement	Entry	Explanation and action
	OGPROT	BTUP	<i>Outgoing protocol</i> Enter BTUP to indicate that the timers are the United Kingdom (UK) variant of national user part timers.
	BTUPT1	1 to 300	<i>Call reanswer timer</i> Enter the time, in seconds, to allow reanswer if the called subscriber releases the line. When the timer expires, a release (REL) message is sent forward and awaits a circuit-free message. This timer is run at the originating node.  The timer starts when the called subscriber clears and stops when an answer message is received.  The default value is 120 (120 s).  <b>Note:</b> This timer cannot be displayed if the EXT file BTUPGWSB is used to datafill this table.

## C7UPTMR signaling protocol BTUP (continued)

### Field descriptions for conditional datafill (Sheet 2 of 4)

Field	Subfield or refinement	Entry	Explanation and action
	BTUPT2	1 to 420	<p><i>Call answer timer</i> Enter the time, in seconds, to wait for call answer after receiving all digits. This timer is run at the originating node.</p> <p>The timer starts when address complete message (ACM) is received and stops when the call is answered. When the timer expires, the call is released.</p> <p>The default value is 120 (120 s).</p> <p><b>Note:</b> This timer cannot be displayed if the EXT (external) file BTUPGWSB is used to datafill this table.</p>
	BTUPT4	1 to 240	<p><i>Circuit overload timer</i> Enter the time, in seconds, after receiving a circuit overload message before releasing the circuit.</p>
	BTUPT9	1 to 90	<p><i>Address complete message timer</i> Enter the time, in seconds, between sending of the initial address message (IAM) and the receipt of an ACM.</p> <p>The timer starts when the IAM is sent and stops when an ACM is received. When the timer expires, then the circuit is released and waits for a circuit-free message.</p> <p>The default value is 20 (20 s).</p>
	BTUPT12	1 to 60	<p><i>Circuit-free message timer</i> Enter the time, in seconds, between the receipt of circuit-free message after sending an REL message.</p> <p>The timer starts when an REL message is sent and stops when the circuit-free signal is received.</p> <p>When the timer expires, the circuit is released giving a reason.</p> <p>The default value is 6 (6 s).</p>

---

**C7UPTMR signaling protocol BTUP** (continued)

---

**Field descriptions for conditional datafill (Sheet 3 of 4)**

Field	Subfield or refinement	Entry	Explanation and action
	BTUPT13	4 to 300	<p><i>Unblocking message timer</i> Enter the time, in seconds, between the receipt of an unblocking (UBL) message after the receipt of a blocking (BLO) message.</p> <p>The timer starts when the BLO signal is received and stops when the UBL signal is received.</p> <p>When the timer expires, the circuit is made busy.</p> <p>The default value is 180 (180 s).</p>
	BTUPT14	1 to 120	<p><i>Additional information request timer</i> Enter the time, in seconds, between requesting additional information and receiving it.</p> <p>The timer starts when the request for additional information is sent and stops when the information is received.</p> <p>When the timer expires, an REL message is sent back giving reason and waits for a forward release message.</p> <p>The default value is 30 (30 s).</p>
	BTUPT16	1 to 300	<p><i>Call setup timer</i> Enter the time, in seconds, that the switch is allowed to set up a single call.</p> <p>The timer starts when the calling line goes off-hook and stops when an ACM is received.</p> <p>When the timer expires, the circuit is released.</p> <p>The default value is 120 (120 s).</p>

## C7UPTMR signaling protocol BTUP (continued)

### Field descriptions for conditional datafill (Sheet 4 of 4)

Field	Subfield or refinement	Entry	Explanation and action
	BTUPT20	4 to 600	<p><i>Notification timer</i> Enter the time, in seconds, between the near-end trunk being busied, and the end office being notified that the near-end trunk was not returned to service.</p> <p>The timer starts when blocking is received and stops when unblocking is received.</p> <p>When the timer expires, the end office is notified that the near-end trunk was not returned to service.</p> <p>The default value is 180 (180 s).</p>
	Q118_1 (-BCS35)	120 to 240	<p><i>Answer signal timer</i> Enter the time, in seconds, to wait for the answer signal after receiving the ACM.</p> <p>The timer starts when an ACM is received and stops when an answer signal is received.</p> <p>When the timer expires, the connection is released.</p> <p>The default value is 180 (180 s).</p>
	Q118_3 (-BCS35)	120 to 240	<p><i>Clear forward timer</i> Enter the time, in seconds, to wait for a clear forward signal after sending a clear back signal.</p> <p>The timer starts when a clear back signal is sent and stops when a clear forward signal is received.</p> <p>When the timer expires, the national part of the connection is released.</p> <p>The default value is 150 (150 s).</p>
OPTIONS (BCS36-)		\$	<p><i>Timer options list</i> No refinements defined. Enter \$.</p>

### Datafill example

The following example shows sample datafill for table C7UPTMR signaling protocol BTUP.

---

## C7UPTMR signaling protocol BTUP (end)

---

**MAP display example for table C7UPTMR signaling protocol BTUP**

TMRKEY C7UPDIR	TMRS
OPTIONS	
<hr/>	
\$	OGBTUP          OG   BTUP 100 100 100 90 60 300 120 10 30



## C7UPTMR signaling protocol CCITT250

---

### CCITT ISUP

Signaling protocol CCITT250 is used for CCITT ISUP.

### Datafill

The following table lists the datafill for table C7UPTMR signaling protocol CCITT250.

#### Field descriptions

Field	Subfield or refinement	Entry	Explanation and action
PROT		see subfields	<i>Protocol</i> If the entry in field C7UPDIR is 2W, this subfield consists of subfield BWPROT described in Section "C7UPDIR = 2W".  If the entry in field C7UPDIR is IC, this subfield consists of subfield ICPROT described in section "C7UPDIR =IC".  If the entry in field C7UPDIR is OG, this subfield consists of subfield OGPROT described in section "C7UPDIR = OG".

## C7UPTMR signaling protocol CCITT250 (continued)

### C7UPDIR = 2W

If the entry subfield C7UPDIR is 2W, datafill subfield BWPROT and refinements as described below, then datafill field OPTIONS.

#### Field descriptions for conditional datafill (Sheet 1 of 12)

Field	Subfield or refinement	Entry	Explanation and action
	BWPROT	CCITT250	<i>Two-way protocol</i> Enter CCITT250 to indicate that the timers are CCITT7 ISUP timers
	NQ764T1	1 to 60	<i>Release complete message timer</i> Enter the time, in seconds, during which the release complete message (RCM) must be received after the release (RLS) message is sent.  The timer starts when the RLS message is sent and stops when the RCM is received.  When the timer expires, the RLS message is repeated and the timer is reinitialized.  The default value is 15 (15 s).
	NQ764T2	1 to 240	<i>User suspend message timer</i> Enter the time, in seconds, that a call can be resumed after the user suspend message is sent.  The timer starts when the controlling switch receives the suspend (user) message and stops on receipt of the resume (user) message at the controlling switch.  When the timer expires, the call is released.  The default value is 180 (180 s).
	NQ764T4	1 to 326	<i>Modification complete timer</i> Enter the time allowed, in seconds, to modify the characteristics of a call if requested by the calling or called party to specialize in the transfer of speech or data.  The timer starts when the local switch sends the call modification message and stops when the modification complete message is received.  The default value is 326 (326 s).

**C7UPTMR signaling protocol CCITT250** (continued)

## Field descriptions for conditional datafill (Sheet 2 of 12)

Field	Subfield or refinement	Entry	Explanation and action
	NQ764T5	1 to 180	<p><i>Release complete message timer</i> Enter the time, in seconds, between sending the RLS message and the receipt of the RCM message.</p> <p>When the timer expires, send a reset circuit (RSC) message, alert maintenance personnel, and remove the circuit from service.</p> <p>The timer starts when the initial RLS message is sent and stops when an RCM is received.</p> <p>The default value is 60 (60 s).</p>
	NQ764T6	1 to 240	<p><i>Call resume timer</i> Enter the time, in seconds, in which a call can be resumed after a network suspend message is sent.</p> <p>The timer starts when the controlling switch receives a suspend (network) message and stops when a resume (network) message is received at the controlling switch.</p> <p>When the timer expires, the circuit is released.</p> <p>The default value is 90 (90 s).</p>
	NQ764T7	1 to 60	<p><i>Address complete message timer</i> Enter the time, in seconds, between the sending of the address message and the receipt of an address complete message (ACM). This ensures the conditions for normal release of address and routing information are met.</p> <p>The timer starts when the latest address message is sent and stops when an ACM is received.</p> <p>When the timer expires, all equipment and connections are released.</p> <p>The default value is 20 (20 s).</p>

## C7UPTMR signaling protocol CCITT250 (continued)

### Field descriptions for conditional datafill (Sheet 3 of 12)

Field	Subfield or refinement	Entry	Explanation and action
	NQ764T8	1 to 60	<p><i>Continuity message timer</i> Enter the time, in seconds, between a transit or an international switch receiving an initial address message (IAM) and the receipt of a continuity (COT) message.</p> <p>The timer starts when a transit or incoming international switch receives an IAM and stops when a COT message is received.</p> <p>When the timer expires, all equipment and connections to the national network are released.</p> <p>The default value is 15 (15 s).</p>
	NQ764T9	1 to 300	<p><i>Answer message timer</i> Enter the time allowed, in seconds, to receive an answer (ANS) message after the controlling or outgoing international switch has received an ACM.</p> <p>The timer starts when either a controlling or outgoing international switch receives an ACM and stops on receipt of an ANS message.</p> <p>When the timer expires, all connections are released.</p> <p>The default value is 180 (180 s).</p>
	NQ764T10	1 to 30	<p><i>Interdigit timer</i> Enter the time allowed, in seconds, between the last digit received and the receipt of additional information.</p> <p>The timer starts when the last digit is received in the interworking situation and stops when fresh information is received.</p> <p>When the timer expires, send an ACM.</p> <p>The default value is 5 (5 s).</p>

**C7UPTMR signaling protocol CCITT250** (continued)

## Field descriptions for conditional datafill (Sheet 4 of 12)

Field	Subfield or refinement	Entry	Explanation and action
	NQ764T11	1 to 60	<p><i>Address complete message timer</i> Enter the time allowed, in seconds, between the receipt of the latest address message in the interworking situation and the receipt of an ACM.</p> <p>The timer starts when the latest address message is received in an interworking situation and stops when an ACM is received.</p> <p>When the timer expires, send an ACM.</p> <p>The default value is 15 (15 s).</p>
	NQ764T12	1 to 60	<p><i>Blocking acknowledgement message timer (first attempt)</i> Enter the time allowed, in seconds, between the sending of the first blocking (BLO) message and the receipt of blocking acknowledgement (BLA) message.</p> <p>The timer starts when a BLO message is sent and stops on receipt of a BLA message.</p> <p>When the timer expires, the BLO message is repeated and the timer is reinitialized.</p> <p>The default value is 10 (10 s).</p>
	NQ764T13	1 to 180	<p><i>Blocking acknowledgement message timer (second attempt)</i> Enter the time allowed, in seconds, between the second or repeated sending of a BLO message and the receipt of a BLA message.</p> <p>The timer starts when the initial BLO message is sent and stops when the BLA message is received.</p> <p>When the timer expires, alert maintenance personnel of the non-receipt of the BLA message and repeat the BLO message at 1-min intervals.</p> <p>The default value is 60 (60 s).</p>

## C7UPTMR signaling protocol CCITT250 (continued)

### Field descriptions for conditional datafill (Sheet 5 of 12)

Field	Subfield or refinement	Entry	Explanation and action
	NQ764T14	1 to 60	<p><i>Unblocking acknowledgement message timer (first attempt)</i> Enter the time allowed, in seconds, between the sending of the first unblocking (UBL) message and the receipt of the unblocking acknowledgement (UBA) message.</p> <p>The timer starts when the UBL message is sent and stops on receipt of the UBA message.</p> <p>When the timer expires, the UBL message is repeated and the timer is reinitialized.</p> <p>The default value is 10 (10 s).</p>
	NQ764T15	1 to 180	<p><i>Unblocking acknowledgement message timer (second attempt)</i> Enter the time allowed, in seconds, between the second or repeated sending of a UBL message and the receipt of a UBA message.</p> <p>The timer starts when the initial UBL message is sent and stops when the UBA message is received.</p> <p>When the timer expires, alert maintenance personnel of the non-receipt of the UBA message and repeat the UBL message at 1-min intervals.</p> <p>The default value is 60 (60 s).</p>
	NQ764T16	1 to 60	<p><i>Release complete message timer (first attempt)</i> Enter the time allowed, in seconds, between the sending of an RSC message and the receipt of an RCM.</p> <p>The timer starts when RSC is sent and stops when an RCM is received.</p> <p>When the timer expires, repeat the RSC message.</p> <p>The default value is 10 (10 s).</p>

**C7UPTMR signaling protocol CCITT250** (continued)

## Field descriptions for conditional datafill (Sheet 6 of 12)

Field	Subfield or refinement	Entry	Explanation and action
	NQ764T17	1 to 180	<p><i>Release complete message timer (second attempt)</i></p> <p>Enter the time allowed, in seconds, between the second or repeated sending of an RSC message and the receipt of an RCM.</p> <p>The timer starts when the initial RSC message is sent and stops when the RCM is received.</p> <p>When the timer expires, alert maintenance personnel of the non-receipt of the RCM and repeat the RSC message at 1-min intervals.</p> <p>The default value is 60 (60 s).</p>
	NQ764T18	1 to 60	<p><i>Group blocking acknowledgement message timer (first attempt)</i></p> <p>Enter the time allowed, in seconds, between the sending of the first group BLO message and the receipt of the group BLA message.</p> <p>The timer starts when a group BLO message is sent and stops when a group BLA message is received.</p> <p>When the timer expires, the group BLO message is repeated and the timer is reinitialized.</p> <p>The default value is 10 (10 s).</p>

---

**C7UPTMR signaling protocol CCITT250** (continued)

---

**Field descriptions for conditional datafill (Sheet 7 of 12)**

Field	Subfield or refinement	Entry	Explanation and action
	NQ764T19	1 to 180	<p><i>Group blocking acknowledgement message timer (second attempt)</i> Enter the time allowed, in seconds, between the second or repeated sending of a group BLO message and the receipt of a group BLA message.</p> <p>The timer starts when the initial group BLO message is sent and stops when the group BLA message is received.</p> <p>When the timer expires, alert maintenance personnel of the non-receipt of group BLA and repeat the group BLO message at 1-min intervals.</p> <p>The default value is 60 (60 s).</p>
	NQ764T20	1 to 60	<p><i>Group unblocking acknowledge message timer (first attempt)</i> Enter the time allowed, in seconds, between the sending of the first group UBL message and the receipt of a group UBA message.</p> <p>The timer starts when a group UBL message is sent and stops when a group UBA message is received.</p> <p>When the timer expires, the group UBL message is repeated and timer is reinitialized.</p> <p>The default value is 10 (10 s).</p>



**C7UPTMR signaling protocol CCITT250** (continued)

## Field descriptions for conditional datafill (Sheet 8 of 12)

Field	Subfield or refinement	Entry	Explanation and action
	NQ764T21	1 to 180	<p><i>Group unblocking acknowledgement message timer (first attempt)</i> Enter the time allowed, in seconds, between the second or repeated sending of a group UBL message and the receipt of a group UBA message.</p> <p>The timer starts when the initial group UBL message is sent and stops when the group UBA acknowledgement message is received.</p> <p>When the timer expires, alert maintenance personnel of the non-receipt of a group UBA message and repeat the group UBL message at 1-min intervals.</p> <p>The default value is 60 (60 s).</p>
	NQ764T22	1 to 60	<p><i>Group release complete message timer (first attempt)</i> Enter the time allowed, in seconds, between the sending of a group RSC message and the receipt of a group RCM.</p> <p>The timer starts when an RSC message is sent and stops when the RCM is received.</p> <p>When the timer expires, repeat the group RSC message.</p> <p>The default value is 10 (10 s).</p>

---

**C7UPTMR signaling protocol CCITT250** (continued)

---

## Field descriptions for conditional datafill (Sheet 9 of 12)

Field	Subfield or refinement	Entry	Explanation and action
	NQ764T23	1 to 180	<p><i>Group release complete message timer (second attempt)</i> Enter the time allowed, in seconds, between the second or repeated sending of a group RSC message and the receipt of a group RSC message.</p> <p>The timer starts when the initial group RSC message is sent and stops when the group RSC message is received.</p> <p>When the timer expires, alert maintenance personnel of the non-receipt of the group RSC message and repeat the group RSC message at 1-min intervals.</p> <p>The default value is 60 (60 s).</p>
	NQ764T24	100 to 2000	<p><i>Backward check tone timer</i> Enter the time allowed, in milliseconds, to receive the backward check tone after the check tone is sent.</p> <p>The timer starts when the check tone is sent and stops when the backward check tone is received.</p> <p>When the timer expires, report the failure.</p> <p>The default value is 1000 (1 s).</p>
	NQ764T25	1 to 30	<p><i>Continuity check request message timer</i> Enter the time allowed, in seconds, after a continuity check failure is detected and the continuity check request message is sent.</p> <p>The timer starts when a continuity check failure is detected and stops when information is not given.</p> <p>When the timer expires, the continuity check request message is sent.</p> <p>The default value is 10 (10 s).</p>

## C7UPTMR signaling protocol CCITT250 (continued)

### Field descriptions for conditional datafill (Sheet 10 of 12)

Field	Subfield or refinement	Entry	Explanation and action
	NQ764T26	1 to 240	<p><i>Second continuity check request message timer</i> Enter the time allowed, in seconds, after the second continuity check failure is detected and the continuity check request message is sent.</p> <p>The timer starts when the second continuity check failure is detected and stops when information is not given.</p> <p>When the timer expires, a continuity check request message is sent.</p> <p>The default value is 120 (120 s).</p>
	NQ764T27	1 to 300	<p><i>Continuity check request message timer</i> Enter the time allowed, in seconds, to receive a continuity check request message after a continuity recheck is requested.</p> <p>The timer starts when continuity recheck is requested and stops when a continuity check request message is received.</p> <p>When the timer expires, return the circuit to idle.</p> <p>The default value is 240 (240 s).</p>
	NQ764T28	1 to 30	<p><i>Circuit group query reception message timer</i> Enter the time allowed, in seconds, to receive a circuit group query reception message after sending a circuit group query message.</p> <p>The timer starts when the circuit group query message is sent and stops when a circuit group query reception message is received.</p> <p>When the timer expires, alert maintenance personnel.</p> <p>The default value is 10 (10 s).</p>

---

**C7UPTMR signaling protocol CCITT250** (continued)

---

**Field descriptions for conditional datafill (Sheet 11 of 12)**

Field	Subfield or refinement	Entry	Explanation and action
	NQ764T35 (-BCS35)	1 to 60	<p><i>Minimum number of digits to commence overlap outpulsing timer</i></p> <p>Enter the time allowed, in seconds, to receive the minimum number of address digits required to commence overlap outpulsing.</p> <p>The timer starts on receipt of an IAM containing less than the minimum number of digits required to commence outpulsing.</p> <p>The timer does not start if the IAM contains an ST signal.</p> <p>The timer is reset each a subsequent address message (SAM) that fails to increment the total number of digits to equal or exceed the minimum required is received.</p> <p>The timer is terminated if an outgoing trunk is seized.</p> <p>When the timer expires, the call is taken down. The treatment of the incoming trunk depends on the datafill in table TMTMAP.</p> <p>The default value is 20 (20 s).</p>

## C7UPTMR signaling protocol CCITT250 (continued)

### Field descriptions for conditional datafill (Sheet 12 of 12)

Field	Subfield or refinement	Entry	Explanation and action
	NQ764T37 (-BCS35)	1 to 30	<p><i>Completion of address digit collection timer</i> Enter the time allowed, in seconds, to receive the remaining address digits.</p> <p>The timer starts on seizure of an outgoing trunk if there is no indication that all digits are received (ST digit or 18 digits).</p> <p>The timer is reset each time a SAM that does not contain an ST digit is received.</p> <p>The timer is terminated on receipt of an ST signal, or on the receipt of an ACM or CON message that indicates the completion of overlap outpulsing.</p> <p>The expiry of this timer indicates that all address digit related to this call are were received and call processing can proceed.</p> <p>The default value is 4 (4 s).</p> <p><b>Note:</b> Outpulsing enbloc cannot commence until after this timer expires.</p>
OPTIONS (BCS36-)		Q33 or \$	<p><i>Timer options list</i> Enter Q33 for the Q33 option and datafill refinement Q33_TIMER. Otherwise, enter \$.</p>
	Q33_TIMER	10 to 30	<p><i>Q33 timer</i> Enter the time, in seconds, for the Q33 timer.</p>

---

**C7UPTMR signaling protocol CCITT250** (continued)

---

**C7UPDIR = IC**

If the entry in subfield C7UPDIR is IC, datafill subfield ICPROT and refinements as described below, then datafill field OPTIONS.

**Field descriptions for conditional datafill (Sheet 1 of 10)**

Field	Subfield or refinement	Entry	Explanation and action
	ICPROT	CCITT250	<i>Incoming protocol</i> Enter CCITT250 to indicate that the timers are CCITT7 ISUP timers.
	NQ764T1	1 to 60	<i>Release complete message timer</i> Enter the time, in seconds, to wait for a release complete message (RCM) after the release (RLS) message is sent.  The timer starts when the RLS message is sent and stops when the RCM is received.  When the timer expires, the RLS message is sent and the timer is reinitialized.  The default value is 15 (15 s).
	NQ764T2	1 to 240	<i>User suspend message timer</i> Enter the time, in seconds, to wait for a call to be resumed after the user suspend (SUS) message is sent.  The timer starts when the controlling switch receives the SUS message and stops when the resume (RES) (user) message is received at the controlling switch.  When the timer expires, the call is released.  The default value is 180 (180 s).
	NQ764T4	1 to 326	<i>Modification complete timer</i> Enter the time allowed, in seconds, to modify the characteristics of a call, if requested by the calling or called party, to specialize in the transfer of speech or data.  The timer starts when the local switch sends the call modification message and stops when the modification complete message is received.  The default value is 326 (326 s).

## C7UPTMR signaling protocol CCITT250 (continued)

### Field descriptions for conditional datafill (Sheet 2 of 10)

Field	Subfield or refinement	Entry	Explanation and action
	NQ764T5	1 to 180	<p><i>Release complete message timer</i> Enter the time, in seconds, between sending the RLS message and receiving the RCM.</p> <p>When the timer expires, send a reset circuit (RSC) signal, alert maintenance personnel, and remove the circuit from service.</p> <p>The timer starts when the initial RLS message is sent and stops when an RCM is received.</p> <p>The default value is 60 (60 s).</p>
	NQ764T6	1 to 240	<p><i>Call resume timer</i> Enter the time, in seconds, to wait for a call to be resumed after a network suspend message is sent.</p> <p>The timer starts when the controlling switch receives an SUS (network) message and stops when an RES (network) message is received at the controlling switch.</p> <p>When the timer expires, the circuit is released.</p> <p>The default value is 90 (90 s).</p>
	NQ764T8	1 to 60	<p><i>Continuity message timer</i> Enter the time, in seconds, between a transit switch or an international switch receiving an initial address message (IAM) and receiving a continuity (COT) message.</p> <p>The timer starts when a transit or incoming international switch receives an IAM and stops when a COT message is received.</p> <p>When the timer expires, all equipment and connections to the national network are released.</p> <p>The default value is 15 (15 s).</p>

---

**C7UPTMR signaling protocol CCITT250** (continued)
 

---

**Field descriptions for conditional datafill (Sheet 3 of 10)**

Field	Subfield or refinement	Entry	Explanation and action
	NQ764T10	1 to 30	<p><i>Interdigit timer</i> Enter the time allowed, in seconds, between the last digit and receiving additional information.</p> <p>The timer starts when the last digit is received in the interworking situation and stops when additional information is received.</p> <p>When the timer expires, send an address complete message (ACM).</p> <p>The default value is 5 (5 s).</p>
	NQ764T11	1 to 60	<p><i>Address complete message timer</i> Enter the time allowed, in seconds, between receiving the latest address message in the interworking situation and receiving an ACM.</p> <p>The timer starts when the latest address message is received in an interworking situation and stops when an ACM is received.</p> <p>When the timer expires, send an ACM.</p> <p>The default value is 15 (15 s).</p>
	NQ764T12	1 to 60	<p><i>Blocking acknowledgement message timer (first attempt)</i> Enter the time allowed, in seconds, between sending the first blocking (BLO) message and receiving the blocking acknowledgement (BLA) message.</p> <p>The timer starts when BLO message is sent and stops when a BLA message is received.</p> <p>When the timer expires, a BLO message is sent and the timer is reinitialized.</p> <p>The default value is 10 (10 s).</p>



## C7UPTMR signaling protocol CCITT250 (continued)

### Field descriptions for conditional datafill (Sheet 4 of 10)

Field	Subfield or refinement	Entry	Explanation and action
	NQ764T13	1 to 180	<p><i>Blocking acknowledgement message timer (second attempt)</i> Enter the time allowed, in seconds, between sending a second or repeated BLO message and receiving a BLA message.</p> <p>The timer starts when the initial BLO message is sent and stops when the BLA message is received.</p> <p>When the timer expires, alert maintenance personnel that a BLA message was not received and send a BLO message at 1-min intervals.</p> <p>The default value is 60 (60 s).</p>
	NQ764T14	1 to 60	<p><i>Unblocking acknowledgement message timer (first attempt)</i> Enter the time allowed, in seconds, between sending the first unblocking (UBL) message and receiving the unblocking acknowledgement (UBA) message.</p> <p>The timer starts when a UBL message is sent and stops when a UBA message is received.</p> <p>When the timer expires, a UBL message is sent and the timer is reinitialized.</p> <p>The default value is 10 (10 s).</p>
	NQ764T15	1 to 180	<p><i>Unblocking acknowledgement message timer (second attempt)</i> Enter the time allowed, in seconds, between the second or repeated UBL message and receiving a UBA message.</p> <p>The timer starts when the initial UBL message is sent and stops when the UBA message is received.</p> <p>When the timer expires, alert maintenance personnel that a UBA message was not received and send a UBL message at 1-min intervals.</p> <p>The default value is 60 (60 s).</p>

---

**C7UPTMR signaling protocol CCITT250** (continued)

---

## Field descriptions for conditional datafill (Sheet 5 of 10)

Field	Subfield or refinement	Entry	Explanation and action
	NQ764T16	1 to 60	<p><i>Release complete message timer (first attempt)</i> Enter the time allowed, in seconds, between sending an RSC message and receiving an RCM.</p> <p>The timer starts when an RSC message is sent and stops when an RCM is received.</p> <p>When the timer expires, send the RSC message again.</p> <p>The default value is 10 (10 s).</p>
	NQ764T17	1 to 180	<p><i>Release complete message timer (second attempt)</i> Enter the time allowed, in seconds, between the second or repeated RSC message and receiving an RCM.</p> <p>The timer starts when the initial RSC message is sent and stops when the RCM is received.</p> <p>When the timer expires, alert maintenance personnel that an RCM was not received and send RSC messages at 1-min intervals.</p> <p>The default value is 60 (60 s).</p>
	NQ764T18	1 to 60	<p><i>Group blocking acknowledgement message timer (first attempt)</i> Enter the time allowed, in seconds, between sending the first group BLO message and receiving the group BLA message.</p> <p>The timer starts when a group BLO message is sent and stops when a group BLA message is received.</p> <p>When the timer expires, the group BLO message is sent and the timer is reinitialized.</p> <p>The default value is 10 (10 s).</p>

**C7UPTMR signaling protocol CCITT250** (continued)

## Field descriptions for conditional datafill (Sheet 6 of 10)

Field	Subfield or refinement	Entry	Explanation and action
	NQ764T19	1 to 180	<p><i>Group blocking acknowledgement message timer (second attempt)</i> Enter the time allowed, in seconds, between the second or repeated group BLO message and receiving a group BLA message.</p> <p>The timer starts when the initial group BLO message is sent and stops when the group BLA message is received.</p> <p>When the timer expires, alert maintenance personnel that a group BLA was not received and send the group BLO message at 1-min intervals.</p> <p>The default value is 60 (60 s).</p>
	NQ764T20	1 to 60	<p><i>Group unblocking acknowledge message timer (first attempt)</i> Enter the time allowed, in seconds, between sending the first group UBL message and receiving a group UBA message.</p> <p>The timer starts when a group UBL message is sent and stops when a group UBA message is received.</p> <p>When the timer expires, the group UBL message is repeated and timer is reinitialized.</p> <p>The default value is 10 (10 s).</p>

## C7UPTMR signaling protocol CCITT250 (continued)

### Field descriptions for conditional datafill (Sheet 7 of 10)

Field	Subfield or refinement	Entry	Explanation and action
	NQ764T21	1 to 180	<p><i>Group unblocking acknowledgement message timer (second attempt)</i> Enter the time allowed, in seconds, between sending the second or repeated group UBL message and receiving of a group UBA message.</p> <p>The timer starts when the initial group UBL message is sent and stops when the group UBA message is received.</p> <p>When the timer expires, alert maintenance personnel that a group UBA message was not received and send the group UBL message at 1-min intervals.</p> <p>The default value is 60 (60 s).</p>
	NQ764T22	1 to 60	<p><i>Group release complete message timer (first attempt)</i> Enter the time allowed, in seconds, between sending a group RES message and receiving a group RLC message.</p> <p>The timer starts when an RSC message is sent and stops when an RCM is received.</p> <p>When the timer expires, send the group RSC message again.</p> <p>The default value is 10 (10 s).</p>
	NQ764T23	1 to 180	<p><i>Group release complete message timer (second attempt)</i> Enter the time allowed, in seconds, between sending the second or repeated group RSC message and receiving a group RCM.</p> <p>The timer starts when the initial group RSC message is sent and stops when the group RCM is received.</p> <p>When the timer expires, alert maintenance personnel that the group RCM was not received and repeat the group RSC message at 1-min intervals.</p> <p>The default value is 60 (60 s).</p>

## C7UPTMR signaling protocol CCITT250 (continued)

### Field descriptions for conditional datafill (Sheet 8 of 10)

Field	Subfield or refinement	Entry	Explanation and action
	NQ764T25	1 to 30	<p><i>Continuity check request message timer</i> Enter the time allowed, in seconds, between detecting a continuity check failure and sending a continuity check request (CCR) message.</p> <p>The timer starts when continuity check failure is detected and stops when information is not given.</p> <p>When the timer expires, the CCR message is sent.</p> <p>The default value is 10 (10 s).</p>
	NQ764T26	1 to 240	<p><i>Second continuity check request message timer</i> Enter the time allowed, in seconds, between detecting a second continuity check failure and sending a CCR message.</p> <p>The timer starts when the second continuity check failure is detected and stops when information is not given.</p> <p>When the timer expires, a CCR message is sent.</p> <p>The default value is 120 (120 s).</p>
	NQ764T27	1 to 300	<p><i>Continuity check request message timer</i> Enter the time allowed, in seconds, to receive a CCR message after a continuity recheck is requested.</p> <p>The timer starts when continuity recheck is requested and stops when a CCR message is received.</p> <p>When the timer expires, return the circuit to idle.</p> <p>The default value is 240 (240 s).</p>

---

**C7UPTMR signaling protocol CCITT250** (continued)

---

**Field descriptions for conditional datafill (Sheet 9 of 10)**

Field	Subfield or refinement	Entry	Explanation and action
	NQ764T28	1 to 30	<p><i>Circuit group query reception message timer</i> Enter the time allowed, in seconds, to receive a circuit group query reception message after sending a circuit group query message.</p> <p>The timer starts when the circuit group query message is sent and stops when a circuit group query reception message is received.</p> <p>When the timer expires, alert maintenance personnel.</p> <p>The default value is 10 (10 s).</p>
	NQ764T35 (-BCS35)	1 to 60	<p><i>Minimum number of digits to commence overlap outpulsing timer</i> Enter the time allowed, in seconds, to receive the minimum number of address digits required to commence overlap outpulsing.</p> <p>The timer starts on receipt of an IAM containing less than the minimum number of digits required to commence outpulsing.</p> <p>The timer does not start if the IAM contains an ST signal.</p> <p>The timer is reset each a subsequent address message (SAM) that fails to increment the total number of digits to equal or exceed the minimum required is received.</p> <p>The timer is terminated if an outgoing trunk is seized.</p> <p>When the timer expires, the call is taken down. The treatment of the incoming trunk depends on the datafill in table TMTMAP.</p> <p>The default value is 20 (20 s).</p>

## C7UPTMR signaling protocol CCITT250 (continued)

### Field descriptions for conditional datafill (Sheet 10 of 10)

Field	Subfield or refinement	Entry	Explanation and action
	NQ764T37 (-BCS35)	1 to 30	<p><i>Completion of address digit collection timer</i> Enter the time allowed, in seconds, to receive the remaining address digits.</p> <p>The timer starts on seizure of an outgoing trunk if there is no indication that all digits are received (ST digit or 18 digits).</p> <p>The timer is reset each time a SAM that does not contain an ST digit is received.</p> <p>The timer is terminated on receipt of an ST signal, or on the receipt of an ACM or CON message that indicates the completion of overlap outpulsing.</p> <p>The expiry of this timer indicates that all address digit related to this call are were received and call processing can proceed.</p> <p>The default value is 4 (4 s).</p> <p><b>Note:</b> Outpulsing enbloc cannot commence until after this timer expires.</p>
OPTIONS (BCS36-)		Q33 or \$	<p><i>Timer options list</i> Enter Q33 for the Q33 option and datafill refinement Q33_TIMER. Otherwise, enter \$.</p>
	Q33_TIMER	10 to 30	<p><i>Q33 timer</i> Enter the time, in seconds, for the Q33 timer.</p>

## C7UPTMR signaling protocol CCITT250 (continued)

### C7UPDIR = OG

If the entry subfield C7UPDIR is OG, datafill subfield OGPROT and refinements as described below, then datafill field OPTIONS.

#### Field descriptions for conditional datafill (Sheet 1 of 6)

Field	Subfield or refinement	Entry	Explanation and action
	OGPROT	CCITT250	<i>Outgoing protocol</i> Enter CCITT250 to indicate that the timers are CCITT7 ISUP timers
	NQ764T1	1 to 60	<i>Release complete message timer</i> Enter the time, in seconds, during which the release complete message (RCM) must be received after the release (RLS) message is sent.  The timer starts when the RLS message is sent and stops when the RCM is received.  When the timer expires, the RLS message is repeated and the timer is reinitialized.  The default value is 15 (15 s).
	NQ764T2	1 to 240	<i>User suspend message timer</i> Enter the time, in seconds, during which a call can be resumed after the user suspend message is sent.  The timer starts when the controlling switch receives the suspend (user) message and stops when the resume (user) message is received at the controlling switch.  When the timer expires, the call is released.  The default value is 180 (180 s).
	NQ764T4	1 to 326	<i>Modification complete timer</i> Enter the time allowed, in seconds, to modify the characteristics of a call if requested by the calling or called party to specialize in the transfer of speech or data.  The timer starts when the local switch sends the call modification message and stops when the modification complete message is received.  The default value is 326 (326 s).



## C7UPTMR signaling protocol CCITT250 (continued)

### Field descriptions for conditional datafill (Sheet 2 of 6)

Field	Subfield or refinement	Entry	Explanation and action
	NQ764T5	1 to 180	<p><i>Release complete message timer</i> Enter the time allowed, in seconds, between sending of the RLS message and the receipt of the RCM.</p> <p>When the timer expires, send a reset circuit (RSC) message, alert maintenance personnel, and remove the circuit from service.</p> <p>The timer starts when the initial RLS message is sent and stops when an RCM is received.</p> <p>The default value is 60 (60 s).</p>
	NQ764T6	1 to 240	<p><i>Call resume timer</i> Enter the time, in seconds, in which a call can be resumed after a network suspend message is sent.</p> <p>The timer starts when the controlling switch receives suspend (network) message and stops when a resume (network) message is received at the controlling switch.</p> <p>When the timer expires, the circuit is released.</p> <p>The default value is 90 (90 s).</p>
	NQ764T7	1 to 60	<p><i>Address complete message timer</i> Enter the time allowed, in seconds, between the sending of the address message and the receipt of an address complete message (ACM). This ensures that the conditions for normal release of address and routing information are met.</p> <p>The timer starts when the latest address message is sent and stops when an ACM is received.</p> <p>When the timer expires, all equipment and connections are released.</p> <p>The default value is 20 (20 s).</p>

---

**C7UPTMR signaling protocol CCITT250** (continued)

---

## Field descriptions for conditional datafill (Sheet 3 of 6)

Field	Subfield or refinement	Entry	Explanation and action
	NQ764T9	1 to 300	<p><i>Answer message timer</i> Enter the time allowed, in seconds, to receive an answer message after the controlling or outgoing international switch received an ACM.</p> <p>The timer starts when either a controlling or outgoing international switch receives an ACM and stops on receipt of an answer message.</p> <p>When the timer expires, all connections are released.</p> <p>The default value is 180 (180 s).</p>
	NQ764T16	1 to 60	<p><i>Release complete message timer (first attempt)</i> Enter the time allowed, in seconds, between the sending of a RSC message and the receipt of an RCM.</p> <p>The timer starts when an RSC message is sent and stops when an RCM is received.</p> <p>When the timer expires, repeat the RSC message.</p> <p>The default value is 10 (10 s).</p>
	NQ764T17	1 to 180	<p><i>Release complete message timer (second attempt)</i> Enter the time allowed, in seconds, between the second or repeated sending of an RSC message and the receipt of a RCM.</p> <p>The timer starts when the initial RSC message is sent and stops when the RCM is received.</p> <p>When the timer expires, alert maintenance personnel of the non-receipt of the RCM and repeat the RSC message at 1-min intervals.</p> <p>The default value is 60 (60 s).</p>

**C7UPTMR signaling protocol CCITT250** (continued)

## Field descriptions for conditional datafill (Sheet 4 of 6)

Field	Subfield or refinement	Entry	Explanation and action
	NQ764T22	1 to 60	<p><i>Group release complete message timer (first attempt)</i> Enter the time allowed, in seconds, between the sending of a group reset circuit message and the receipt of a group release complete message.</p> <p>The timer starts when an RSC message is sent and stops when RCM is received.</p> <p>When the timer expires, repeat the group reset circuit message.</p> <p>The default value is 10 (10 s).</p>
	NQ764T23	1 to 180	<p><i>Group release complete message timer (second attempt)</i> Enter the time allowed, in seconds, between the second or repeated sending of a group reset circuit message and the receipt of a group release circuit message.</p> <p>The timer starts when the initial group reset circuit message is sent and stops when the group release circuit message is received.</p> <p>When the timer expires, alert maintenance personnel of the non-receipt of the group release circuit message and repeat the group reset circuit at 1-min intervals.</p> <p>The default value is 60 (60 s).</p>
	NQ764T24	100 to 2000	<p><i>Backward check tone timer</i> Enter the time allowed, in milliseconds, to receive the backward check tone after the check tone is sent.</p> <p>The timer starts when the check tone is sent and stops when the backward check tone is received.</p> <p>When the timer expires, report the failure.</p> <p>The default value is 1000 (1 s).</p>

---

**C7UPTMR signaling protocol CCITT250** (continued)

---

**Field descriptions for conditional datafill (Sheet 5 of 6)**

Field	Subfield or refinement	Entry	Explanation and action
	NQ764T25	1 to 30	<p><i>Continuity check request message timer</i> Enter the time allowed, in seconds, after continuity check failure is detected and the continuity check request (CCR) message is sent.</p> <p>The timer starts when continuity check failure is detected and stops when information is not given.</p> <p>When the timer expires, the CCR message is sent.</p> <p>The default value is 10 (10 s).</p>
	NQ764T26	1 to 240	<p><i>Second continuity check request message timer</i> Enter the time allowed, in seconds, after the second continuity check failure is detected and the CCR message is sent.</p> <p>The timer starts when the second continuity check failure is detected and stops when information is not given.</p> <p>When the timer expires, a CCR message is sent.</p> <p>The default value is 120 (120 s).</p>
	NQ764T27	1 to 300	<p><i>Continuity check request message timer</i> Enter the time allowed, in seconds, to receive a CCR message after a continuity recheck is requested.</p> <p>The timer starts when continuity recheck is requested and stops when a CCR message is received.</p> <p>When the timer expires, return the circuit to idle.</p> <p>The default value is 240 (240 s).</p>

**C7UPTMR signaling protocol CCITT250 (end)**

**Field descriptions for conditional datafill (Sheet 6 of 6)**

Field	Subfield or refinement	Entry	Explanation and action
	NQ764T28	1 to 30	<p><i>Circuit group query reception message timer</i> Enter the time allowed, in seconds, to receive a circuit group query reception message after sending a circuit group query message.</p> <p>The timer starts when the circuit group query message is sent and stops when a circuit group query reception message is received.</p> <p>When the timer expires, alert maintenance personnel.</p> <p>The default value is 10 (10 s).</p>
OPTIONS (BCS36-)		\$	<p><i>Timer options list</i> No refinements defined. Enter \$.</p>

**Datafill example**

The following example shows sample datafill for table C7UPTMR signaling protocol CCITT250.

**MAP display example for table C7UPTMR signaling protocol CCITT250**

```

TMRKEY C7UPDIR
                                TMRS
OPTIONS
-----
OGCCITT250      OG  CCITT250 15 10 90 10 90 60 90 60 60
60 60 100 30 200 100 30      $
    
```

---

## C7UPTMR signaling protocol IBNISUP

---

### Integrated Business Network 7

Signaling protocol IBNISUP used for Integrated Business Network 7 (IBN7), also known as American National Standards Institute 7 (ANSI7), call processing, and IBN7-to-IBN7 for global networking (GN) calls.

### Datafill

The following table lists the datafill for table C7UPTMR signaling protocol IBNISUP.

### Field descriptions

Field	Subfield or refinement	Entry	Explanation and action
	PROT	see subfields	<p><i>Protocol</i>If the entry in field C7UPDIR is 2W, this subfield consists of subfield BWPROT described in section "C7UPDIR = 2W".</p> <p>If the entry in field C7UPDIR is IC, this subfield consists of subfield ICPROT described in section "C7UPDIR = IC".</p> <p>If the entry in field C7UPDIR is OG, this subfield consists of subfield OGPROT described in section "C7UPDIR = OG".</p>

---

**C7UPTMR signaling protocol IBNISUP** (continued)

---

**C7UPDIR = 2W**

If the entry subfield C7UPDIR is 2W, datafill subfield BWPROT and refinements as described below, then datafill field OPTIONS.

**Field descriptions for conditional datafill (Sheet 1 of 7)**

Field	Subfield or refinement	Entry	Explanation and action
	BWPROT	IBNISUP	<p><i>Two-way protocol</i> Enter IBNISUP to indicate that the timers are Integrated Business Network 7 (IBN7) ISUP timers for full IBN7 call processing.</p>
	COT	10 to 15	<p><i>Continuity timer</i> Enter the time, in seconds, to wait for a continuity (COT) or release (REL) message after responding to a continuity test request in the initial address message (IAM).</p> <p>The timer starts when a continuity test request is received in the IAM and stops when a COT or REL message is received.</p> <p>When the timer expires, a reset circuit (RSC) message is sent.</p> <p>The default value is 13 (13 s).</p>
	TONE	2	<p><i>Tone timer</i> Enter the time, 2 s, to wait for the reception of a suitable tone and its removal from the far end, after requesting a continuity check in an IAM.</p> <p>The timer starts when the request for a continuity check is sent and stops when a suitable tone is received and removed.</p> <p>When the timer expires, an RSC message is sent.</p> <p>The default value is 2 (2 s).</p>

---

**C7UPTMR signaling protocol IBNISUP** (continued)

---

**Field descriptions for conditional datafill (Sheet 2 of 7)**

Field	Subfield or refinement	Entry	Explanation and action
	ACM	20 to 30	<p><i>Address complete timer</i> Enter the time, in seconds, to wait for an address complete message (ACM), an answer message (ANM), or a release (REL) message after sending an IAM.</p> <p>The timer starts when an IAM is sent and stops on receipt of an ACM, ANM, or a REL message.</p> <p>When the timer expires, the call is routed to reorder tone.</p> <p>The default value is 25 (25 s).</p>
	RLCSREL	4 to 15	<p><i>Release complete after sending release short timer</i> Enter the time, in seconds, to wait for a release complete (RLC) message after sending an REL message. When the REL message is sent, timers RLCSREL and RLCLREL start and wait for an RLC message. If no RLC message is received by the time timer RLCSREL expires, a second REL message is sent and timer RLCSREL is reset. This process continues until timer RLCLREL expires.</p> <p>The timer starts when a REL message is sent and stops on receipt of an RLC message.</p> <p>The default value is 6 (6 s).</p>



## C7UPTMR signaling protocol IBNISUP (continued)

### Field descriptions for conditional datafill (Sheet 3 of 7)

Field	Subfield or refinement	Entry	Explanation and action
	RLCLREL	60	<p><i>Release complete after sending release long timer</i></p> <p>Enter the time, 60 s, to wait for an RLC message after sending an REL message. When a REL message is sent, timers RLCSREL and RLCLREL start and wait for an RLC message. If no RLC message is received by the time timer RLCSREL expires, a second REL message is sent and timer RLCSREL is reset. This process continues until timer RLCLREL expires.</p> <p>The timer starts when the first REL message is sent and stops when an RLC message is received.</p> <p>When the timer expires:</p> <ul style="list-style-type: none"> <li>• An RSC message is sent to the far end.</li> <li>• A log is produced to notify the maintenance personnel.</li> <li>• The sending of REL messages stops.</li> <li>• The circuit is removed from service.</li> <li>• Additional RSC messages are sent at 1-min intervals until an RLC message is received or until maintenance intervenes.</li> </ul> <p>The default value is 60 (60 s).</p>
	IRETEST	1 to 10	<p><i>Initial retest timer</i></p> <p>Enter the time, in seconds, to wait before sending a continuity check request (CCR) message after receiving the first continuity test failure.</p> <p>The timer starts when the first continuity test failure is received and stops when a CCR message is sent.</p> <p>When the timer expires, a CCR message is sent.</p> <p>The default value is 10 (10 s).</p>

---

**C7UPTMR signaling protocol IBNISUP** (continued)

---

**Field descriptions for conditional datafill (Sheet 4 of 7)**

Field	Subfield or refinement	Entry	Explanation and action
	SRETEST	60 to 180	<p><i>Subsequent retest timer</i> Enter the time, in seconds, to wait before sending a CCR message after receiving a subsequent continuity test failure.</p> <p>The timer starts when the subsequent continuity test failure is received and stops when the CCR message is sent.</p> <p>When the timer expires, a CCR message is sent and a log is produced to notify the maintenance personnel.</p> <p>The default value is 180 (180 s).</p>
	ICCR	16 to 20	<p><i>Initial continuity check request message timer</i> Enter the time allowed, in seconds, after the first continuity test failure is detected and the CCR message is received.</p> <p>The timer starts when continuity check failure is detected and stops when the CCR message is received.</p> <p>When the timer expires, an RSC message is sent.</p> <p>The default value is 20 (20 s).</p>
	SCCR	180 to 300	<p><i>Subsequent continuity check request message timer</i> Enter the time allowed, in seconds, after the second continuity check failure is detected and the CCR message is received.</p> <p>The timer starts when the second continuity check failure is detected and stops when a CCR message is received.</p> <p>When the timer expires, an RSC message is sent.</p> <p>The default value is 200 (200 s).</p>

**C7UPTMR signaling protocol IBNISUP** (continued)

## Field descriptions for conditional datafill (Sheet 5 of 7)

Field	Subfield or refinement	Entry	Explanation and action
	RLCSRSC	4 to 15	<p><i>Release complete after sending reset circuit short timer</i></p> <p>Enter the time, in seconds, to wait for the RLC message after sending an RSC message. When the RSC message is sent, timers RLCSRSC and RLCLRSC start and wait for an RLC message. If no RLC message is received by the time timer RLCSRSC expires, a second RSC message is sent and timer RLCSRSC is reset. This process continues until timer RLCLRSC expires.</p> <p>The timer starts when the RSC message is sent and stops on receipt of an RLC message.</p> <p>The default value is 13 (13 s).</p>
	RLCLRSC	60	<p><i>Release complete after sending reset circuit long timer</i></p> <p>Enter the time, 60 s, to wait for the RLC message after sending an RSC message. When the RSC message is sent, timers RLCSRSC and RLCLRSC start and wait for an RLC message. If no RLC message is received by the time timer RLCSRSC expires, a second RSC message is sent and timer RLCSRSC is reset. This process continues until timer RLCLRSC expires.</p> <p>The timer starts when the first RSC message is sent and stops when an RLC message is received.</p> <p>When the timer expires, a log is produced to notify the maintenance personnel.</p> <p>The default value is 60 (60 s).</p>

## C7UPTMR signaling protocol IBNISUP (continued)

### Field descriptions for conditional datafill (Sheet 6 of 7)

Field	Subfield or refinement	Entry	Explanation and action
	LPA	2	<p><i>Loopback acknowledgement timer</i> Enter the time, 2 s, to wait for receipt of a loopback acknowledge (LPA) message after sending a CCR message.</p> <p>The timer starts when a CCR message is sent and stops on receipt of an LPA message.</p> <p>When the timer expires, the central control (CC), computing module (CM), or message switch (MS) is informed that continuity (COT) failed and a COT message indicating "continuity check failed" is sent to the far end. After timer SRETEST expires, another continuity test is performed.</p> <p>The default value is 2 (2 s).</p>
	EXM	30 to 40	<p><i>Exit message timer</i> This is an ISUP equal access timer. Enter the time, in seconds, to wait for an exit message (EXM) after sending an IAM.</p> <p>The timer starts when the IAM is sent and stops on receipt of an EXM.</p> <p>When the timer expires, the call is routed to reorder tone.</p> <p>The default value is 32 (32 s).</p>
	CRM	3 to 4	<p><i>Circuit reservation message timer</i> This is an ISUP equal access timer. Enter the time, in seconds, to wait for a circuit reservation acknowledge (CRA) message after sending a circuit reservation message (CRM).</p> <p>The timer starts when a CRM is sent and stops on receipt of a CRA.</p> <p>When the timer expires, a failure message is sent to the CC, the timer is reset, and another attempt is made.</p> <p>The default value is 3 (3 s).</p>

**C7UPTMR signaling protocol IBNISUP** (continued)

## Field descriptions for conditional datafill (Sheet 7 of 7)

Field	Subfield or refinement	Entry	Explanation and action
	WEXD	0 to 1200	<p><i>Exit message delay timer</i> This timer is an ISUP equal access timer.</p> <p>Enter the time, in milliseconds, to delay the sending of the EXM to synchronize the sending of the IAM forward and the sending of the EXM backward.</p> <p>The timer starts when the IAM is sent forward.</p> <p>When the timer expires, the EXM is sent backward.</p> <p>The default value is 600 (600 ms).</p>
OPTIONS (BCS36-)		\$	<p><i>Timer options list</i> No refinements defined. Enter \$.</p>

**C7UPDIR = IC**

If the entry in subfield C7UPDIR is IC, datafill subfield ICPROT and refinements as described below, then datafill field OPTIONS.

## Field descriptions for conditional datafill (Sheet 1 of 5)

Field	Subfield or refinement	Entry	Explanation and action
	ICPROT	IBNISUP	<p><i>Incoming protocol</i> Enter IBNISUP to indicate that the timers are Integrated Business Network 7 (IBN7) ISUP timers for full IBN7 call processing.</p>
	COT	10 to 15	<p><i>Continuity timer</i> Enter the time, in seconds, to wait for a continuity (COT) or release (REL) message after responding to a continuity test request in the initial address message (IAM).</p> <p>The timer starts when a continuity test request is received in the IAM and stops when a COT message is received.</p> <p>When the timer expires, a reset circuit (RSC) message is sent.</p> <p>The default value is 13 (13 s).</p>

---

**C7UPTMR signaling protocol IBNISUP** (continued)
 

---

**Field descriptions for conditional datafill (Sheet 2 of 5)**

Field	Subfield or refinement	Entry	Explanation and action
	RLCSREL	4 to 15	<p data-bbox="867 464 1398 520"><i>Release complete after sending release short timer</i></p> <p data-bbox="867 527 1398 842">Enter the time, in seconds, to wait for a release complete (RLC) message after sending an REL message. When an REL message is sent, timers RLCSREL and RLCLREL start and wait for an RLC message. If no RLC message is received by the time timer RLCSREL expires, a second REL message is sent and timer RLCSREL is reset. This process continues until timer RLCLREL expires.</p> <p data-bbox="867 863 1398 947">The timer starts when an REL message is sent and stops when an RLC message is received.</p> <p data-bbox="867 968 1398 999">The default value is 6 (6 s).</p>

## C7UPTMR signaling protocol IBNISUP (continued)

### Field descriptions for conditional datafill (Sheet 3 of 5)

Field	Subfield or refinement	Entry	Explanation and action
	RLCLREL	60	<p><i>Release complete after sending release long timer</i></p> <p>Enter the time, 60 s, to wait for an RLC message after sending an REL message. When an REL message is sent, timers RLCSREL and RLCLREL start and wait for an RLC message. If no RLC message is received by the time timer RLCSREL expires, a second REL message is sent and timer RLCSREL is reset. This process continues until timer RLCLREL expires.</p> <p>The timer starts when the first REL is sent and stops when an RLC is received.</p> <p>When the timer expires</p> <ul style="list-style-type: none"> <li>• An RSC message is sent to the far end.</li> <li>• A log is produced to notify maintenance personnel.</li> <li>• REL message sending stops.</li> <li>• The circuit is removed from service.</li> <li>• Additional RSC messages are sent at 1-min intervals until an RLC message is received or until maintenance intervenes.</li> </ul> <p>The default value is 60 (60 s).</p>
	ICCR	16 to 20	<p><i>Initial continuity check request message timer</i></p> <p>Enter the time allowed, in seconds, between detecting the first continuity test failure and receiving the continuity check request (CCR) message.</p> <p>The timer starts when continuity check failure is detected and stops when a CCR message is received.</p> <p>When the timer expires, an RSC message is sent.</p> <p>The default value is 20 (20 s).</p>

---

**C7UPTMR signaling protocol IBNISUP** (continued)

---

**Field descriptions for conditional datafill (Sheet 4 of 5)**

Field	Subfield or refinement	Entry	Explanation and action
	SCCR	180 to 300	<p><i>Subsequent continuity check request message timer</i></p> <p>Enter the time allowed, in seconds, between detecting the second continuity check failure and receiving the CCR message.</p> <p>The timer starts when the second continuity check failure is detected and stops when a CCR message is received.</p> <p>When the timer expires, an RSC message is sent.</p> <p>The default value is 200 (200 s).</p>
	RLCSRSC	4 to 15	<p><i>Release complete after sending reset circuit short timer</i></p> <p>Enter the time, in seconds, to wait for the RLC message after sending an RSC message. When an RSC message is sent, timers RLCSRSC and RLCLRSC start and wait for an RLC message. If no RLC message is received by the time timer RLCSRSC expires, a second RSC message is sent and timer RLCSRSC is reset. This process continues until timer RLCLRSC expires.</p> <p>The timer starts when the RSC message is sent and stops when an RLC message is received.</p> <p>The default value is 13 (13 s).</p>



**C7UPTMR signaling protocol IBNISUP** (continued)

## Field descriptions for conditional datafill (Sheet 5 of 5)

Field	Subfield or refinement	Entry	Explanation and action
	RLCLRSC	60	<p><i>Release complete after sending reset circuit long timer</i></p> <p>Enter the time, 60 s, to wait for the RLC message after sending an RSC message. When an RSC message is sent, timers RLCSRSC and RLCLRSC start and wait for an RLC message. If no RLC message is received by the time timer RLCSRSC expires, a second RSC message is sent and timer RLCSRSC is reset. This process continues until timer RLCLRSC expires.</p> <p>The timer starts when the first RSC message is sent and stops when an RLC message is received.</p> <p>When the timer expires, a log is produced to notify the maintenance personnel.</p> <p>The default value is 60 (60 s).</p>
	WEXD	0 to 1200	<p><i>Exit message delay timer</i></p> <p>This timer is an ISUP equal access timer. Enter the time, in milliseconds, to delay the sending of the exit message (EXM) to synchronize the sending of the IAM forward and the sending of the EXM backward. The timer starts when the IAM is sent forward. When the timer expires, the EXM is sent backward.</p> <p>The default value is 600 (600 ms).</p>
OPTIONS (BCS36-)		\$	<p><i>Timer options list</i></p> <p>No refinements defined. Enter \$.</p>

---

**C7UPTMR signaling protocol IBNISUP** (continued)

---

**C7UPDIR = OG**

If the entry subfield C7UPDIR is OG, datafill subfield OGPROT and refinements as described below, then datafill field OPTIONS.

**Field descriptions for conditional datafill (Sheet 1 of 6)**

Field	Subfield or refinement	Entry	Explanation and action
	OGPROT	IBNISUP	<i>Outgoing protocol</i> Enter IBNISUP to indicate that the timers are Integrated Business Network 7 (IBN7) ISUP timers for full IBN7 call processing
	TONE	2	<i>Tone timer</i> Enter the time, 2 s, to wait for the reception of a suitable tone and its removal from the far end, after requesting a continuity check in an initial address message (IAM).  The timer starts when the request for a continuity check is sent and stops when a suitable tone is received and removed.  When the timer expires, a reset circuit (RSC) message is sent.  The default value is 2 (2 s).
	ACM	20 to 30	<i>Address complete timer</i> Enter the time, in seconds, to wait for an address complete message (ACM), an answer message (ANM), or a release (REL) message after sending an IAM.  The timer starts when IAM is sent and stops on receipt of an ACM, ANM, or an REL message.  When the timer expires, the call is routed to reorder tone.  The default value is 25 (25 s).

---

**C7UPTMR signaling protocol IBNISUP** (continued)

---

**Field descriptions for conditional datafill (Sheet 2 of 6)**

<b>Field</b>	<b>Subfield or refinement</b>	<b>Entry</b>	<b>Explanation and action</b>
	RLCSREL	4 to 15	<p><i>Release complete after sending release short timer</i></p> <p>Enter the time, in seconds, to wait for a release complete message (RLC) after sending an REL message. When the REL message is sent, timers RLCSREL and RLCLREL start and wait for an RLC message. If no RLC message is received, by the time timer RLCSREL expires, a second REL message is sent and timer RLCSREL is reset. This process continues until timer RLCLREL expires.</p> <p>The timer starts when an REL message is sent and stops on receipt of an RLC message.</p> <p>The default value is 6 (6 s).</p>

## C7UPTMR signaling protocol IBNISUP (continued)

### Field descriptions for conditional datafill (Sheet 3 of 6)

Field	Subfield or refinement	Entry	Explanation and action
	RLCLREL	60	<p><i>Release complete after sending release long timer</i></p> <p>Enter the time, 60 s, to wait for a RLC message after sending an REL message. When an REL message is sent, timers RLCSREL and RLCLREL start and wait for an RLC message. If no RLC message is received by the time timer RLCSREL expires, a second REL message is sent and timer RLCSREL is reset. This process continues until timer RLCLREL expires.</p> <p>The timer starts when the first REL message is sent and stops when the RLC message is received.</p> <p>When the timer expires:</p> <ul style="list-style-type: none"> <li>• An RSC message is sent to the far end.</li> <li>• A log is produced to notify the maintenance personnel.</li> <li>• The sending of REL messages stops.</li> <li>• The circuit is removed from service.</li> <li>• Additional RSC messages are sent at 1-min intervals until an RLC message is received or until maintenance intervenes.</li> </ul> <p>The default value is 60 (60 s).</p>
	IRETEST	1 to 10	<p><i>Initial retest timer</i></p> <p>Enter the time, in seconds, to wait before sending a continuity check request (CCR) message after receiving the first continuity test failure.</p> <p>The timer starts when the first continuity test failure is received and stops when a CCR message is sent.</p> <p>When the timer expires, a CCR message is sent.</p> <p>The default value is 10 (10 s).</p>

## C7UPTMR signaling protocol IBNISUP (continued)

### Field descriptions for conditional datafill (Sheet 4 of 6)

Field	Subfield or refinement	Entry	Explanation and action
	SRETEST	60 to 180	<p><i>Subsequent retest timer</i> Enter the time, in seconds, to wait before sending a CCR message after receiving a subsequent continuity test failure.</p> <p>The timer starts when the subsequent continuity test failure is received and stops when a CCR message is sent.</p> <p>When the timer expires, a CCR message is sent and a log is produced to notify the maintenance personnel.</p> <p>The default value is 180 (180 s).</p>
	RLCSRSC	4 to 15	<p><i>Release complete after sending reset circuit short timer</i> Enter the time, in seconds, to wait for the RLC message after sending an RSC message. When an RSC message is sent, timers RLCSRSC and RLCLRSC start and wait for an RLC message. If no RLC message is received by the time timer RLCSRSC expires, a second RSC message is sent and timer RLCSRSC is reset. This process continues until timer RLCLRSC expires.</p> <p>The timer starts when the RSC message is sent and stops on receipt of an RLC message.</p> <p>The default value is 13 (13 s).</p>

## C7UPTMR signaling protocol IBNISUP (continued)

### Field descriptions for conditional datafill (Sheet 5 of 6)

Field	Subfield or refinement	Entry	Explanation and action
	RLCLRSC	60	<p><i>Release complete after sending reset circuit long timer</i></p> <p>Enter the time, 60 s, to wait for the RLC message after sending an RSC message. When an RSC message is sent, timers RLCSRSC and RLCLRSC start and wait for an RLC message. If no RLC message is received by the time timer RLCSRSC expires, a second RSC message is sent and timer RLCSRSC is reset. This process continues until timer RLCLRSC expires.</p> <p>The timer starts when the first RSC message is sent and stops when the RLC message is received.</p> <p>When the timer expires, a log is produced to notify the maintenance personnel.</p> <p>The default value is 60 (60 s).</p>
	LPA	2	<p><i>Loopback acknowledgement timer</i></p> <p>Enter the time, 2 s, to wait for receipt of a loopback acknowledge (LPA) message after sending a CCR message.</p> <p>The timer starts when a CCR message is sent and stops on receipt of an LPA message.</p> <p>When the timer expires, the central control (CC), computing module (CM), or message switch (MS) is informed that continuity (COT) failed and a COT message indicating "continuity check failed" is sent to the far end. After timer SRETEST expires another continuity test is performed.</p> <p>The default value is 2 (2 s).</p>

## C7UPTMR signaling protocol IBNISUP (continued)

### Field descriptions for conditional datafill (Sheet 6 of 6)

Field	Subfield or refinement	Entry	Explanation and action
	EXM	30 to 40	<p><i>Exit message timer</i> This is an ISUP equal access timer. Enter the time, in seconds, to wait for an exit message (EXM) after sending an IAM.</p> <p>The timer starts when the IAM is sent and stops on receipt of an EXM.</p> <p>When the timer expires, the call is routed to reorder tone.</p> <p>The default value is 32 (32 s).</p>
	CRM	3 to 4	<p><i>Circuit reservation message timer</i> This is an ISUP equal access timer. Enter the time, in seconds, to wait for a circuit reservation acknowledge (CRA) message after sending a circuit reservation message (CRM).</p> <p>The timer starts when a CRM is sent and stops on receipt of a CRA message.</p> <p>When the timer expires, a failure message is sent to the CC, the timer is reset, and another attempt is made.</p> <p>The default value is 3 (3 s).</p>
OPTIONS (BCS36-)		\$	<p><i>Timer options list</i> No refinements defined. Enter \$.</p>

### Datafill example

The following example shows sample datafill for table C7UPTMR signaling protocol IBNISUP.





## C7UPTMR signaling protocol JPNISUP

---

### Japan Public Network 7

Signaling protocol JPNISUP is used for Japan Public Network 7 (JPN7) trunks in DMS-100 switches.

### Datafill

The following table lists the datafill for table C7UPTMR signaling protocol JPNISUP.

#### Field descriptions

Field	Subfield or refinement	Entry	Explanation and action
	PROT	JPNISUP	<p><i>Protocol</i></p> <p>Enter JPNISUP to indicate that the timers are for Japanese Public Network 7 (JPN7) ISUP trunks on the DMS-100 switch.</p> <p>If the entry in field C7UPDIR is 2W, this subfield consists of subfield BWPROT described in section "C7UPDIR = 2W".</p> <p>If the entry in field C7UPDIR is IC, this subfield consists of subfield ICPROT described in section "C7UPDIR = IC".</p> <p>If the entry in field C7UPDIR is OG, this subfield consists of subfield OGPROT described in section "C7UPDIR = OG".</p>

---

**C7UPTMR signaling protocol JPNISUP** (continued)

---

**C7UPDIR = 2W**

If the entry in subfield C7UPDIR is 2W, datafill subfield BWPROT and refinements as described below, then datafill field OPTIONS.

**Field descriptions for conditional datafill (Sheet 1 of 5)**

Field	Subfield or refinement	Entry	Explanation and action
	BWPROT	see subfields	<i>Two-way protocol</i>
	JPNT1	1 to 60	<p><i>Release complete message timer</i> Enter the time, in seconds, during which the release complete (RLC) message must be received after the release (REL) message is sent.</p> <p>The timer starts when the REL message is sent and stops when the RLC message is received.</p> <p>When the timer expires, the REL message is repeated and the timer is reinitialized.</p> <p>The default value is 6 (6 s).</p>
	JPNT5	1 to 180	<p><i>Release complete message timer</i> Enter the time, in seconds, between sending of the REL message and the receipt of the RLC message.</p> <p>When the timer expires, send a reset circuit (RSC) message, alert maintenance personnel, and remove the circuit from service.</p> <p>The timer starts when the initial REL message is sent and stops when the RLC message is received.</p> <p>The default value is 60 (60 s).</p>

## C7UPTMR signaling protocol JPNISUP (continued)

### Field descriptions for conditional datafill (Sheet 2 of 5)

Field	Subfield or refinement	Entry	Explanation and action
	JPNT6	1 to 60	<p><i>Call resume timer</i> Enter the time, in seconds, in which a call can be resumed after a network suspend message is sent.</p> <p>The timer starts when the controlling switch receives suspend (network) message and stops when a resume (network) message is received at the controlling switch.</p> <p>When the timer expires, the circuit is released.</p> <p>The default value is 1 (1 s).</p>
	JPNT7	1 to 60	<p><i>Address complete message timer</i> Enter the time, in seconds, between the sending of the address message and the receipt of an address complete message (ACM). This ensures that the conditions for normal release of address and routing information are met.</p> <p>The timer starts when the latest address message is sent and stops when an ACM is received.</p> <p>When the timer expires, all equipment and connections are released.</p> <p>The default value is 25 (25 s).</p>
	JPNT8	1 to 60	<p><i>Continuity message timer</i> Enter the time, in seconds, between a transit or an international switch receiving an initial address message (IAM) and the receipt of a continuity (COT) message.</p> <p>The timer starts when a transit or incoming international switch receives an IAM and stops when a COT message is received.</p> <p>When the timer expires, all equipment and connections to the national network are released.</p> <p>The default value is 13 (13 s).</p>

## C7UPTMR signaling protocol JPNISUP (continued)

### Field descriptions for conditional datafill (Sheet 3 of 5)

Field	Subfield or refinement	Entry	Explanation and action
	JPNT12	1 to 60	<p><i>Blocking acknowledgement message timer (first attempt)</i> Enter the time allowed, in seconds, between the sending of the first blocking (BLO) message and the receipt of blocking acknowledgement (BLA) message.</p> <p>The timer starts when a BLO message is sent and stops on receipt of the BLA message.</p> <p>When the timer expires, the BLO message is repeated and the timer is reinitialized.</p> <p>The default value is 8 (8 s).</p>
	JPNT14	1 to 60	<p><i>Unblocking acknowledgement message timer (first attempt)</i> Enter the time allowed, in seconds, between the sending of the first unblocking (UBL) message and the receipt of the unblocking acknowledgement (UBA) message.</p> <p>The timer starts when the UBL message is sent and stops on receipt of the UBA message.</p> <p>When the timer expires, the UBL message is repeated and the timer is reinitialized.</p> <p>The default value is 12 (12 s).</p>
	JPNT16	1 to 60	<p><i>Release complete message timer (first attempt)</i> Enter the time allowed, in seconds, between the sending of an RSC message and the receipt of the RLC message.</p> <p>The timer starts when an RSC message is sent and stops when an RLC message is received.</p> <p>When the timer expires, repeat the RSC message.</p> <p>The default value is 13 (13 s).</p>

## C7UPTMR signaling protocol JPNISUP (continued)

### Field descriptions for conditional datafill (Sheet 4 of 5)

Field	Subfield or refinement	Entry	Explanation and action
	JPNT17	1 to 180	<p><i>Release complete message timer (second attempt)</i> Enter the time allowed, in seconds, between the second or repeated sending of an RSC message and the receipt of an RLC message.</p> <p>The timer starts when the initial RSC message is sent and stops when the RLC message is received.</p> <p>When the timer expires, alert maintenance personnel of the non-receipt of the RLC message and repeat the RSC message at 1-min intervals.</p> <p>The default value is 60 (60 s).</p>
	JPNT22	1 to 60	<p><i>Group release complete message timer</i> Enter the time allowed, in seconds, between the sending of a group reset circuit message and the receipt of a group release complete message.</p> <p>The timer starts when an RSC message is sent and stops when an RLC message is received.</p> <p>When the timer expires, repeat the group reset circuit message.</p> <p>The default value is 12 (12 s).</p>

## C7UPTMR signaling protocol JPNISUP (continued)

### Field descriptions for conditional datafill (Sheet 5 of 5)

Field	Subfield or refinement	Entry	Explanation and action
	JPNTLPBK	1 to 180	<p><i>Loopback acknowledgement timer</i> Enter the time, in seconds, to wait for receipt of a loopback acknowledge (LPA) message after sending a continuity check request (CCR) message.</p> <p>The timer starts when the CCR message is sent and stops on receipt of the LPA message.</p> <p>When the timer expires, the central control (CC), computing module (CM), or message switch (MS) is informed that COT failed and a COT message indicating "continuity check failed" is sent to the far end.</p> <p>The default value is 30 (30 s).</p>
OPTIONS (BCS36-)		\$	<p><i>Timer options list</i> No refinements defined. Enter \$.</p>

### C7UPDIR = IC

If the entry in subfield C7UPDIR is IC, datafill subfield ICPROT and refinements as described below, then datafill field OPTIONS.

### Field descriptions for conditional datafill (Sheet 1 of 4)

Field	Subfield or refinement	Entry	Explanation and action
	ICPROT	see subfields	<i>Incoming protocol</i>
	JPNT1	1 to 60	<p><i>Release complete message timer</i> Enter the time, in seconds, during which the release complete (RLC) message must be received after the release (REL) message is sent.</p> <p>The timer starts when the REL message is sent and stops when the RLC message is received.</p> <p>When the timer expires, the REL message is repeated and the timer is reinitialized.</p> <p>The default value is 6 (6 s).</p>

## C7UPTMR signaling protocol JPNISUP (continued)

### Field descriptions for conditional datafill (Sheet 2 of 4)

Field	Subfield or refinement	Entry	Explanation and action
	JPNT5	1 to 180	<p><i>Release complete message timer</i> Enter the time, in seconds, between sending of the REL message and the receipt of the RLC message.</p> <p>When the timer expires, send a reset circuit (RSC) message, alert maintenance personnel, and remove the circuit from service.</p> <p>The timer starts when the initial REL message is sent and stops when an RLC is received.</p> <p>The default value is 60 (60 s).</p>
	JPNT8	1 to 60	<p><i>Continuity message timer</i> Enter the time, in seconds, between a transit or an international switch receiving an initial address message (IAM) and the receipt of a continuity (COT) message.</p> <p>The timer starts when a transit or incoming international switch receives an IAM and stops when a COT message is received.</p> <p>When the timer expires, all equipment and connections to the national network are released.</p> <p>The default value is 13 (13 s).</p>
	JPNT12	1 to 60	<p><i>Blocking acknowledgement message timer (first attempt)</i> Enter the time allowed, in seconds, between the sending of the first blocking (BLO) message and the receipt of blocking acknowledgement (BLA) message.</p> <p>The timer starts when a BLO message is sent and stops on receipt of the BLA message.</p> <p>When the timer expires, the BLO message is repeated and the timer is reinitialized.</p> <p>The default value is 8 (8 s).</p>

**C7UPTMR signaling protocol JPNISUP** (continued)

## Field descriptions for conditional datafill (Sheet 3 of 4)

Field	Subfield or refinement	Entry	Explanation and action
	JPNT14	1 to 60	<p><i>Unblocking acknowledgement message timer (first attempt)</i> Enter the time allowed, in seconds, between the sending of the first unblocking (UBL) message and the receipt of the unblocking acknowledgement (UBA) message.</p> <p>The timer starts when the UBL message is sent and stops on receipt of the UBA message.</p> <p>When the timer expires, the UBL message is repeated and the timer is reinitialized.</p> <p>The default value is 12 (12 s).</p>
	JPNT16	1 to 60	<p><i>Release complete message timer (first attempt)</i> Enter the time allowed, in seconds, between the sending of an RSC message and the receipt of an RLC message.</p> <p>The timer starts when an RSC message is sent and stops when an RLC message is received.</p> <p>When the timer expires, repeat the RSC message.</p> <p>The default value is 13 (13 s).</p>
	JPNT17	1 to 180	<p><i>Release complete message timer (second attempt)</i> Enter the time allowed, in seconds, between the second or repeated sending of an RSC message and the receipt of an RLC message.</p> <p>The timer starts when the initial RSC message is sent and stops when the RLC message is received.</p> <p>When the timer expires, alert maintenance personnel of the non-receipt of an RLC message and repeat the RSC message at 1-min intervals.</p> <p>The default value is 60 (60 s).</p>



**C7UPTMR signaling protocol JPNISUP** (continued)

## Field descriptions for conditional datafill (Sheet 4 of 4)

Field	Subfield or refinement	Entry	Explanation and action
	JPNT22	1 to 60	<p><i>Group release complete message timer</i> Enter the time allowed, in seconds, between the sending of a group RSC message and the receipt of a group RLC message.</p> <p>The timer starts when the RSC message is sent and stops when an RLC message is received.</p> <p>When the timer expires, repeat the group RSC message.</p> <p>The default value is 12 (12 s).</p>
OPTIONS (BCS36-)		\$	<p><i>Timer options list</i> No refinements defined. Enter \$.</p>

**C7UPDIR = OG**

If the entry subfield C7UPDIR is OG, datafill subfield OGPROT and refinements as described below, then datafill field OPTIONS.

## Field descriptions for conditional datafill (Sheet 1 of 5)

Field	Subfield or refinement	Entry	Explanation and action
	OGPROT	see subfields	<i>Outgoing protocol</i>
	JPNT1	1 to 60	<p><i>Release complete message timer</i> Enter the time, in seconds, during which the release complete (RLC) message must be received after the release (REL) message is sent.</p> <p>The timer starts when the REL message is sent and stops when the RLC message is received.</p> <p>When the timer expires, the REL message is repeated and the timer is reinitialized.</p> <p>The default value is 6 (6 s).</p>

## C7UPTMR signaling protocol JPNISUP (continued)

### Field descriptions for conditional datafill (Sheet 2 of 5)

Field	Subfield or refinement	Entry	Explanation and action
	JPNT5	1 to 180	<p><i>Release complete message timer</i> Enter the time, in seconds, between sending of the REL message and the receipt of the RLC message.</p> <p>When the timer expires, send the RSC message, alert maintenance personnel, and remove the circuit from service.</p> <p>The timer starts when the initial REL message is sent and stops when the RLC message is received.</p> <p>The default value is 60 (60 s).</p>
	JPNT6	1 to 60	<p><i>Call resume timer</i> Enter the time, in seconds, in which a call can be resumed after a network suspend message is sent.</p> <p>The timer starts when the controlling switch receives suspend (network) message and stops when a resume (network) message is received at the controlling switch.</p> <p>When the timer expires, the circuit is released.</p> <p>The default value is 0.01 (10 ms).</p>
	JPNT7	1 to 60	<p><i>Address complete message timer</i> Enter the time, in seconds, between the sending of the address message and the receipt of an address complete message (ACM). This ensures that the conditions for normal release of address and routing information are met.</p> <p>The timer starts when the latest address message is sent and stops when an ACM is received.</p> <p>When the timer expires, all equipment and connections are released.</p> <p>The default value is 25 (25 s).</p>

## C7UPTMR signaling protocol JPNISUP (continued)

### Field descriptions for conditional datafill (Sheet 3 of 5)

Field	Subfield or refinement	Entry	Explanation and action
	JPNT12	1 to 60	<p><i>Blocking acknowledgement message timer (first attempt)</i> Enter the time allowed, in seconds, between the sending of the first blocking (BLO) message and the receipt of blocking acknowledgement (BLA) message.</p> <p>The timer starts when a BLO message is sent and stops on receipt of the BLA message.</p> <p>When the timer expires, the BLO message is repeated and the timer is reinitialized.</p> <p>The default value is 8 (8 s).</p>
	JPNT14	1 to 60	<p><i>Unblocking acknowledgement message timer (first attempt)</i> Enter the time allowed, in seconds, between the sending of the first unblocking (UBL) message and the receipt of the unblocking acknowledgement (UBA) message.</p> <p>The timer starts when the UBL message is sent and stops on receipt of the UBA message.</p> <p>When the timer expires, the UBL message is repeated and the timer is reinitialized.</p> <p>The default value is 12 (12 s).</p>
	JPNT16	1 to 60	<p><i>Release complete message timer (first attempt)</i> Enter the time allowed, in seconds, between the sending of an RSC message and the receipt of the RLC message.</p> <p>The timer starts when the RSC message is sent and stops when the RLC message is received.</p> <p>When the timer expires, repeat the RSC message.</p> <p>The default value is 13 (13 s).</p>

---

**C7UPTMR signaling protocol JPNISUP** (continued)

---

**Field descriptions for conditional datafill (Sheet 4 of 5)**

Field	Subfield or refinement	Entry	Explanation and action
	JPNT17	1 to 180	<p><i>Release complete message timer (second attempt)</i></p> <p>Enter the time allowed, in seconds, between the second or repeated sending of an RSC message and the receipt of an RLC message.</p> <p>The timer starts when the initial RSC message is sent and stops when the RLC message is received.</p> <p>When the timer expires, alert maintenance personnel of the non-receipt of the RLC message and repeat the RSC message at 1-min intervals.</p> <p>The default value is 60 (60 s).</p>
	JPNT22	1 to 60	<p><i>Group release complete message timer</i></p> <p>Enter the time allowed, in seconds, between the sending of a group reset circuit message and the receipt of a group release complete message.</p> <p>The timer starts when the RSC message is sent and stops when the RLC message is received.</p> <p>When the timer expires, repeat the group reset circuit message.</p> <p>The default value is 12 (12 s).</p>



---

## C7UPTMR signaling protocol MBTUP

---

### Operating company specific network interworking

Signaling protocol MBTUP is used for interworking within operating company-specific networks.

### Datafill

The following table lists the datafill for table C7UPTMR signaling protocol MBTUP.

#### Field descriptions

Field	Subfield or refinement	Entry	Explanation and action
	PROT	see subfields	<p><i>Protocol</i></p> <p>If the entry in field C7UPDIR is 2W, this subfield consists of subfield BWPROT described in Section "C7UPDIR = 2W".</p> <p>If the entry in field C7UPDIR is IC, this subfield consists of subfield ICPROT described in Section "C7UPDIR = IC".</p> <p>If the entry in field C7UPDIR is OG, this subfield consists of subfield OGPROT described in Section "C7UPDIR + OG".</p>

#### C7UPDIR = 2W

If the entry subfield C7UPDIR is 2W, datafill subfield BWPROT and refinements as described below, then datafill field OPTIONS.

**Note:** The BTUPT<sub>n</sub> (n = 1, 2, 3, 5) timers cannot be displayed if the EXT (external) file BTUPGWSB is used to datafill this table. This is normally the case on the integrated services switching unit (DMS-300). These fields do not appear if any display command, such as RANGE and CHANGE, is requested at the MAP (maintenance and administration position) within the table editor.

## C7UPTMR signaling protocol MBTUP (continued)

### Field descriptions for conditional datafill (Sheet 1 of 8)

Field	Subfield or refinement	Entry	Explanation and action
	BWPROT	MBTUP	<p><i>Two-way protocol</i> Enter MBTUP to indicate that the timers are a customer-specific version of the BTUP timers.</p>
	BTUPT1	1 to 300	<p><i>Reanswer timer</i> Enter the time, in seconds, to allow reanswer if the called subscriber releases the line. When the timer expires, a release (REL) message is sent forward and awaits a circuit free message. This timer is run at the originating node.</p> <p>The timer starts when the called subscriber clears and stops when an answer (ANS) message is received.</p> <p>The default value is 120 (120 s).</p> <p><b>Note:</b> This timer cannot be displayed if the EXT (external) file BTUPGWSB is used to datafill this table.</p>
	BTUPT2	1 to 420	<p><i>Call answer timer</i> Enter the time, in seconds, to wait for the call answer after receiving all digits. This timer is run at the originating node.</p> <p>The timer starts when address complete message (ACM) is received and stops when the call is answered.</p> <p>When the timer expires, the call is released.</p> <p>The default value is 120 (120 s).</p> <p><b>Note:</b> This timer cannot be displayed if the EXT file BTUPGWSB is used to datafill this table.</p>

## C7UPTMR signaling protocol MBTUP (continued)

### Field descriptions for conditional datafill (Sheet 2 of 8)

Field	Subfield or refinement	Entry	Explanation and action
	BTUPT3	1 to 300	<p><i>Call reanswer timer</i> Enter the time, in seconds, to allow reanswer after the called subscriber releases the line. This timer is run at the terminating node.</p> <p>The timer starts when the called subscriber clears first and stops when a reanswer or forward release message is received.</p> <p>When the timer expires, an REL message is sent back giving a reason and waits for forward release.</p> <p>The default value is 210 (210 s).</p> <p><b>Note:</b> This timer cannot be displayed if the EXT file BTUPGWSB is used to datafill this table.</p>
	BTUPT4	1 to 240	<p><i>Circuit overload timer</i> Enter the time, in seconds, after receiving a circuit overload message before releasing the circuit.</p> <p>The timer starts when an overload signal is received and is not canceled. When the timer expires, the circuit is released.</p> <p>The default value is 90 (90 s).</p>
	BTUPT5	2 to 600	<p><i>Call answer timer</i> Enter the time, in seconds, to wait for a call answer after dialing is complete. This timer is run at the terminating node.</p> <p>The timer starts when an ACM is sent and stops when the call is answered.</p> <p>When the timer expires, the call is released.</p> <p>The default value is 180 (180 s).</p> <p><b>Note:</b> This timer cannot be displayed if the EXT file BTUPGWSB is used to datafill this table.</p>



## C7UPTMR signaling protocol MBTUP (continued)

### Field descriptions for conditional datafill (Sheet 3 of 8)

Field	Subfield or refinement	Entry	Explanation and action
	BTUPT6	1 to 30	<p><i>Minimum digits timer</i> Enter the time, in seconds, between receiving the minimum number of digits and receiving a subsequent digit.</p> <p>The timer starts when the minimum number of digits were received and stops when a subsequent digit is received.</p> <p>When the timer expires, the circuit is released.</p> <p>The default value is 4 (4 s).</p>
	BTUPT8	4 to 120	<p><i>Blocking or unblocking acknowledgement message timer</i> Enter the time, in seconds, between the sending of a blocking (BLO) or unblocking (UBL) message and the receipt of a blocking acknowledgement (BLA) or unblocking acknowledgement (UBA) message.</p> <p>The timer starts when BLO or UBL is sent and stops when BLA or UBA is received.</p> <p>When the timer expires and the UBL message was sent three times without acknowledgement, the circuit is returned to idle.</p> <p>The default value is 30 (30 s).</p>
	BTUPT9	1 to 90	<p><i>Address complete message timer</i> Enter the time, in seconds, between sending of the initial address message (IAM) and the receipt of an ACM.</p> <p>The timer starts when an IAM is sent and stops when an ACM is received.</p> <p>When the timer expires, then the circuit is released and waits for a circuit-free message.</p> <p>The default value is 20 (20 s).</p>

## C7UPTMR signaling protocol MBTUP (continued)

### Field descriptions for conditional datafill (Sheet 4 of 8)

Field	Subfield or refinement	Entry	Explanation and action
	BTUPT10	1 to 120	<p><i>Forward release message timer</i> Enter the time, in seconds, to wait for a forward release message after an REL message is sent backwards.</p> <p>The timer starts when an REL message is sent and stops when an REL message is received.</p> <p>When the timer expires and an REL message was sent backwards twice, then it is assumed that forward release message was received and the circuit is freed.</p> <p>The default value is 6 (6 s).</p>
	BTUPT12	1 to 60	<p><i>Circuit free message timer</i> Enter the time, in seconds, between the receipt of circuit free message after sending an REL message.</p> <p>The timer starts when an REL message is sent and stops when the circuit free signal is received.</p> <p>When the timer expires, the circuit is released giving a reason.</p> <p>The default value is 6 (6 s).</p>
	BTUPT13	4 to 300	<p><i>Unblocking message timer</i> Enter the time, in seconds, between the receipt of an unblocking (UBL) message after the receipt of a blocking (BLO) message.</p> <p>The timer starts when the BLO signal is received and stops when the UBL signal is received.</p> <p>When the timer expires, the circuit is made busy.</p> <p>The default value is 180 (180 s).</p>

## C7UPTMR signaling protocol MBTUP (continued)

### Field descriptions for conditional datafill (Sheet 5 of 8)

Field	Subfield or refinement	Entry	Explanation and action
	BTUPT14	1 to 120	<p><i>Additional information request timer</i> Enter the time, in seconds, between requesting additional information and receiving it.</p> <p>The timer starts when the request for additional information is sent and stops when the information is received.</p> <p>When the timer expires, an REL message is sent back giving a reason and waits for a forward release message.</p> <p>The default value is 30 (30 s).</p>
	BTUPT15	1 to 60	<p><i>Initial or subsequent digit reception timer</i> Enter the time, in seconds, that the circuit waits for the initial or a subsequent digit.</p> <p>The timer starts when a seizure occurs (line goes off-hook) or if a digit is received and stops when a subsequent digit is received.</p> <p>When the timer expires, the circuit is released.</p> <p>The default value is 20 (20 s).</p>
	BTUPT16	1 to 300	<p><i>Call setup timer</i> Enter the time, in seconds, that the switch is allowed to set up a single call.</p> <p>The timer starts when the calling line goes off-hook and stops when an ACM is received.</p> <p>When the timer expires, the circuit is released.</p> <p>The default value is 120 (120 s).</p>

## C7UPTMR signaling protocol MBTUP (continued)

### Field descriptions for conditional datafill (Sheet 6 of 8)

Field	Subfield or refinement	Entry	Explanation and action
	BTUPT17	1 to 60	<p><i>Send-all-digits timer</i> Enter the time, in seconds, between sending a send-all-digits message and receiving a subsequent address message (SAM) or a final address message (FAM).</p> <p>The timer starts after sending a send-all-digits message and stops when a subsequent SAM or FAM is received.</p> <p>When the timer expires, a call failure message with reason is sent back and the circuit is released giving a reason.</p> <p>The default value is 20 (20 s).</p>
	BTUPT18	1 to 300	<p><i>Send-n-digits timer</i> Enter the time, in seconds, between sending a send-n-digits message and receiving a SAM or a FAM.</p> <p>The timer starts after sending a send-n-digits message and stops when a subsequent SAM or FAM is received.</p> <p>When the timer expires, a call failure message with reason is sent back and the circuit is released giving a reason.</p> <p>The default value is 180 (180 s).</p>
	BTUPT19	1 to 300	<p><i>Holding incoming circuit timer</i> Enter the time, in seconds, that an incoming circuit is held after rejecting the call due to an overload condition.</p> <p>The timer starts when the overload signal is sent and stops when the release signal is received.</p> <p>When the timer expires, an REL signal is sent back giving a reason.</p> <p>The default value is 180 (180 s).</p>

## C7UPTMR signaling protocol MBTUP (continued)

### Field descriptions for conditional datafill (Sheet 7 of 8)

Field	Subfield or refinement	Entry	Explanation and action
	BTUPT20	4 to 600	<p><i>Notification timer</i> Enter the time, in seconds, between the near-end trunk being busied, and the end office being notified that the near-end trunk was not returned to service.</p> <p>The timer starts when blocking is received and stops when an unblocking message is received.</p> <p>When the timer expires, the end office is notified that the near-end trunk was not returned to service.</p> <p>The default value is 180 (180 s).</p>
	Q118_1	120 to 240	<p><i>Answer signal timer</i> Enter the time, in seconds, to wait for the answer signal after receiving the ACM.</p> <p>The timer starts when an ACM is received and stops when an answer signal is received.</p> <p>When the timer expires, the connection is released.</p> <p>The default value is 180 (180 s).</p>
	Q118_2	60 to 120	<p><i>Release or reanswer signal timer</i> Enter the time, in seconds, to wait for a release from the calling subscriber or a reanswer from the called subscriber after receiving a clear back signal.</p> <p>The timer starts when a clear back signal is received and stops when a release or reanswer signal is received.</p> <p>When the timer expires, the international part of the connection is released and charging for the call is stopped.</p> <p>The default value is 90 (90 s).</p>

---

**C7UPTMR signaling protocol MBTUP** (continued)

---

**Field descriptions for conditional datafill (Sheet 8 of 8)**

Field	Subfield or refinement	Entry	Explanation and action
	Q118_3	120 to 180	<p><i>Clear forward timer</i> Enter the time, in seconds, to wait for a clear forward signal after sending a clear back signal.</p> <p>The timer starts when a clear back signal is sent and stops when a clear forward signal is received.</p> <p>When the timer expires, the national part of the connection is released.</p> <p>The default value is 150 (150 s).</p>
OPTIONS (BCS36-)		\$	<p><i>Timer options list</i> No refinements defined. Enter \$.</p>

**C7UPDIR = IC**

If the entry in subfield C7UPDIR is IC, datafill subfield ICPROT and refinements as described below, then datafill field OPTIONS.

**Note:** Timers BTUPT3 and BTUPT5 cannot be displayed if the EXT (external) file BTUPGWSB is used to datafill this table. This is normally the case on the DMS-300 integrated services switching unit (ISSU). These fields do not appear if any display command, such as RANGE and CHANGE, is requested at the MAP (maintenance and administration position) within the table editor.

## C7UPTMR signaling protocol MBTUP (continued)

### Field descriptions for conditional datafill (Sheet 1 of 5)

Field	Subfield or refinement	Entry	Explanation and action
	ICPROT	MBTUP	<p><i>Incoming protocol</i> Enter MBTUP to indicate that the timers are an operating company-specific version of the BTUP timers.</p>
	BTUPT3	1 to 300	<p><i>Call reanswer timer</i> Enter the time, in seconds, to wait for reanswer (RAN) signal after the called subscriber releases the line. This timer runs at the terminating node.</p> <p>The timer starts when the called subscriber clears first and stops when a RAN signal or a release forward signal is received.</p> <p>When the timer expires, release is sent back giving a reason and the timer waits for forward release.</p> <p>The default value is 210 (210 s).</p> <p><b>Note:</b> This timer cannot be displayed if the EXT (external) file BTUPGWSB is used to datafill this table.</p>
	BTUPT5	2 to 600	<p><i>Call answer timer</i> Enter the time, in seconds, to wait for call answer after dialing is complete. This timer runs at the terminating node.</p> <p>The timer starts when an address complete message (ACM) is sent and stops when the call is answered. When the timer expires, the call is released.</p> <p>The default value is 180 (180 s).</p> <p><b>Note:</b> This timer cannot be displayed if the EXT file BTUPGWSB is used to datafill this table.</p>

## C7UPTMR signaling protocol MBTUP (continued)

### Field descriptions for conditional datafill (Sheet 2 of 5)

Field	Subfield or refinement	Entry	Explanation and action
	BTUPT6	1 to 30	<p><i>Minimum digits timer</i> Enter the time allowed, in seconds, between receiving the minimum number of digits and receiving a subsequent digit.</p> <p>The timer starts when the minimum number of digits were received and stops when a subsequent digit is received.</p> <p>When the timer expires, the circuit is released.</p> <p>The default value is 4 (4 s).</p>
	BTUPT8	4 to 120	<p><i>Blocking or unblocking acknowledgement message timer</i> Enter the time allowed, in seconds, between the sending of a blocking (BLO) or unblocking (UBL) message and receiving a blocking acknowledgement (BLA) or an unblocking acknowledgement (UBA) message.</p> <p>The timer starts when a BLO or UBL message is sent and stops when a BLA or UBA message is received.</p> <p>When the timer expires and the UBL message was sent three times without acknowledgement, the circuit is returned to idle.</p> <p>The default value is 30 (30 s).</p>
	BTUPT10	1 to 120	<p><i>Forward release message timer</i> Enter the time, in seconds, to wait for a forward release message after a release (REL) message is sent backwards.</p> <p>The timer starts when an REL message is sent backwards and stops when an REL message is received.</p> <p>When the timer expires and an REL message was sent backwards twice, then it is assumed that a release forward message was received and the circuit is freed.</p> <p>The default value is 6 (6 s).</p>



## C7UPTMR signaling protocol MBTUP (continued)

### Field descriptions for conditional datafill (Sheet 3 of 5)

Field	Subfield or refinement	Entry	Explanation and action
	BTUPT12	1 to 60	<p><i>Circuit-free message timer</i> Enter the time allowed, in seconds, between sending an REL message and receiving a circuit-free message.</p> <p>The timer starts when an REL message is sent and stops when the circuit-free signal is received.</p> <p>When the timer expires, the circuit is released giving a reason.</p> <p>The default value is 6 (6 s).</p>
	BTUPT14	1 to 120	<p><i>Additional information request timer</i> Enter the time allowed, in seconds, between requesting additional information and receiving it.</p> <p>The timer starts when a request for additional information is sent and stops when the information is received.</p> <p>When the timer expires, an REL message is sent back giving a reason and waits for a forward release message.</p> <p>The default value is 30 (30 s).</p>
	BTUPT15	1 to 60	<p><i>Initial or subsequent digit reception timer</i> Enter the time, in seconds, that the circuit waits for the initial or a subsequent digit.</p> <p>The timer starts when a seizure occurs (line goes off-hook) or when a digit is received, and stops when a subsequent digit is received.</p> <p>When the timer expires, the circuit is released.</p> <p>The default value is 20 (20 s).</p>

## C7UPTMR signaling protocol MBTUP (continued)

### Field descriptions for conditional datafill (Sheet 4 of 5)

Field	Subfield or refinement	Entry	Explanation and action
	BTUPT17	1 to 60	<p><i>Send-all-digits timer</i> Enter the time allowed, in seconds, between sending a send-all-digits message and receiving a subsequent address message (SAM) or a final address message (FAM).</p> <p>The timer starts after sending a send-all-digits message and stops when a SAM or FAM is received.</p> <p>When the timer expires, call failure (CFL) message with reason is sent back and the circuit is released giving a reason.</p> <p>The default value is 20 (20 s).</p>
	BTUPT18	1 to 300	<p><i>Send-n-digits timer</i> Enter the time allowed, in seconds, between sending a send-n-digits message and receiving a SAM or a FAM.</p> <p>The timer starts after sending a send-n-digits message and stops when a SAM or FAM is received.</p> <p>When the timer expires, a CFL message with reason is sent back and the circuit is released giving a reason.</p> <p>The default value is 180 (180 s).</p>
	BTUPT19	1 to 300	<p><i>Holding incoming circuit timer</i> Enter the time, in seconds, that an incoming circuit is held after rejecting the call due to an overload condition.</p> <p>The timer starts when the overload signal is sent and stops when the release signal is received.</p> <p>When the timer expires, a release signal is sent back giving a reason.</p> <p>The default value is 180 (180 s).</p>

## C7UPTMR signaling protocol MBTUP (continued)

### Field descriptions for conditional datafill (Sheet 5 of 5)

Field	Subfield or refinement	Entry	Explanation and action
	BTUPT20	4 to 600	<p><i>Notification timer</i> Enter the time allowed, in seconds, between the near-end trunk being busied, and the end office being notified that the near-end trunk was not returned to service.</p> <p>The timer starts when a BLO message is received and stops when an UBL message is received.</p> <p>When the timer expires, the end office is notified that the near-end trunk was not returned to service.</p> <p>The default value is 180 (180 s).</p>
	Q118_1	120 to 240	<p><i>Answer signal timer</i> Enter the time, in seconds, to wait for the answer signal after receiving the ACM.</p> <p>The timer starts when an ACM is received and stops when an answer signal is received.</p> <p>When the timer expires, the connection is released.</p> <p>The default value is 180 (180 s).</p>
	Q118_2	60 to 120	<p><i>Release or reanswer signal timer</i> Enter the time, in seconds, to wait for a release from the calling subscriber or a RAN from the called subscriber after receiving a clear back (CBK) signal.</p> <p>The timer starts when a CBK signal is received and stops when an REI or RAN signal is received.</p> <p>When the timer expires, the international part of the connection is released and charging for the call is stopped.</p> <p>The default value is 90 (90 s).</p>
OPTIONS (BCS36-)		\$	<p><i>Timer options list</i> No refinements defined. Enter \$.</p>

---

**C7UPTMR signaling protocol MBTUP** (continued)
 

---

**C7UPDIR = OG**

If the entry subfield C7UPDIR is OG, datafill subfield OGPROT and refinements as described below, then datafill field OPTIONS.

**Note:** The BTUPT1 and BTUPT2 timers cannot be displayed if the EXT (external) file BTUPGWSB is used to datafill this table. This is normally the case on the integrated services switching unit (DMS-300). These fields do not appear if any display command, such as range and change, is requested at the MAP (maintenance and administration position) within the table editor.

**Field descriptions for conditional datafill (Sheet 1 of 5)**

Field	Subfield or refinement	Entry	Explanation and action
	OGPROT	MBTUP	<i>Outgoing protocol</i> Enter MBTUP to indicate that the timers are a customer-specific version of the BTUP timers.
	BTUPT1	1 to 300	<i>Reanswer timer</i> Enter the time, in seconds, to allow reanswer if the called subscriber releases the line. When the timer expires, a release message is sent forward and awaits a circuit-free message. This timer runs at the originating node.  The timer starts when the called subscriber clears and stops when an answer message is received.  The default value is 120 (120 s).  <b>Note:</b> This timer cannot be displayed if the EXT (external) file BTUPGWSB is used to datafill this table.

## C7UPTMR signaling protocol MBTUP (continued)

### Field descriptions for conditional datafill (Sheet 2 of 5)

Field	Subfield or refinement	Entry	Explanation and action
	BTUPT2	1 to 420	<p><i>Call answer timer</i> Enter the time, in seconds, to wait for call answer after receiving all digits.</p> <p>This timer runs at the originating node. The timer starts when address complete message (ACM) is received and stops when the call is answered.</p> <p>When the timer expires, the call is released.</p> <p>The default value is 120 (120 s).</p> <p><b>Note:</b> This timer cannot be displayed if the EXT file BTUPGWSB is used to datafill this table.</p>
	BTUPT4	1 to 240	<p><i>Circuit overload timer</i> Enter the time, in seconds, after receiving a circuit overload message before releasing the circuit.</p> <p>The timer starts when an overload signal is received and is not canceled. When the timer expires, the circuit is released.</p> <p>The default value is 90 (90 s).</p>
	BTUPT9	1 to 90	<p><i>Address complete message timer</i> Enter the time, in seconds, between sending of the initial address message (IAM) and the receipt of an ACM.</p> <p>The timer starts when IAM is sent and stops when an ACM is received. When the timer expires, the circuit is released and waits for a circuit-free message.</p> <p>The default value is 20 (20 s).</p>

---

**C7UPTMR signaling protocol MBTUP** (continued)
 

---

**Field descriptions for conditional datafill (Sheet 3 of 5)**

Field	Subfield or refinement	Entry	Explanation and action
	BTUPT12	1 to 60	<p><i>Circuit-free message timer</i> Enter the time, in seconds, between the receipt of circuit-free message after sending a release (REL) message.</p> <p>The timer starts when a release is sent and stops when the circuit-free signal is received.</p> <p>When the timer expires, the circuit is released giving a reason.</p> <p>The default value is 6 (6 s).</p>
	BTUPT13	4 to 300	<p><i>Unblocking message timer</i> Enter the time, in seconds, between the receipt of an (UBL) unblocking message after the receipt of a blocking (BLO) message.</p> <p>The timer starts when the blocking signal is received and stops when the unblocking signal is received.</p> <p>When the timer expires, the circuit is made busy.</p> <p>The default value is 180 (180 s).</p>
	BTUPT14	1 to 120	<p><i>Additional information request timer</i> Enter the time, in seconds, between requesting additional information and receiving it.</p> <p>The timer starts when the request for additional information is sent and stops when the information is received.</p> <p>When the timer expires, an REL message is sent back giving reason and waits for a forward release message.</p> <p>The default value is 30 (30 s).</p>

## C7UPTMR signaling protocol MBTUP (continued)

### Field descriptions for conditional datafill (Sheet 4 of 5)

Field	Subfield or refinement	Entry	Explanation and action
	BTUPT16	1 to 300	<p><i>Call setup timer</i> Enter the time, in seconds, that the switch is allowed to set up a single call.</p> <p>The timer starts when the calling line goes off-hook and stops when an ACM is received.</p> <p>When the timer expires, the circuit is released.</p> <p>The default value is 120 (120 s).</p>
	BTUPT20	4 to 600	<p><i>Notification timer</i> Enter the time, in seconds, between the near-end trunk being busied, and the end office being notified that the near-end trunk was not returned to service.</p> <p>The timer starts when a BLO message is received and stops when a UBL message is received.</p> <p>When the timer expires, the end office is notified that the near-end trunk was not returned to service.</p> <p>The default value is 180 (180 s).</p>
	Q118_1	120 to 240	<p><i>Answer signal timer</i> Enter the time, in seconds, to wait for the answer signal after receiving the ACM.</p> <p>The timer starts when an ACM is received and stops when an answer signal is received.</p> <p>The default value is 180 (180 s).</p>

## C7UPTMR signaling protocol MBTUP (end)

### Field descriptions for conditional datafill (Sheet 5 of 5)

Field	Subfield or refinement	Entry	Explanation and action
	Q118_3	120 to 180	<p><i>Clear forward timer</i> Enter the time, in seconds, to wait for a clear forward signal after sending a clear back signal.</p> <p>The timer starts when a clear back signal is sent and stops when a clear forward signal is received.</p> <p>When the timer expires, the national part of the connection is released.</p> <p>The default value is 150 (150 s).</p>
OPTIONS (BCS36-)		\$	<p><i>Timer options list</i> No refinements defined. Enter \$.</p>

### Datavill example

The following example shows sample datafill for table C7UPTMR signaling protocol MBTUP.

### MAP display example for table C7UPTMR signaling protocol MBTUP

TMRKEY C7UPDIR	TMRS
OPTIONS	
180 180 150	OG MBTUP 120 120 90 20 6 180 30 120
OGMBTUP	\$



## C7UPTMR signaling protocol NCCI

---

### Operating company specific CCITT7 protocols

NCCI is used if the operating company-specific CCITT7 protocols (NCCI7) are packaged on the DMS-100 switch.

### Datafill

The following table lists the datafill for table C7UPTMR signaling protocol NCCI.

#### Field descriptions

Field	Subfield or refinement	Entry	Explanation and action
	PROT	see subfields	<i>Protoco</i> If the entry in field C7UPDIR is 2W, this subfield consists of subfield BWPROT described oin Section "C7UPDIR = 2W".  If the entry in field C7UPDIR is IC, this subfield consists of subfield ICPROT described in Section "C7UPDIR = IC".  If the entry in field C7UPDIR is OG, this subfield consists of subfield OGPROT described in Section "C7UPDIR = OG".

---

**C7UPTMR signaling protocol NCCI** (continued)

---

**C7UPDIR = 2W**

If the entry subfield C7UPDIR is 2W, datafill subfield BWPROT and refinements as described below, then datafill field OPTIONS.

**Field descriptions for conditional datafill (Sheet 1 of 6)**

Field	Subfield or refinement	Entry	Explanation and action
	BWPROT	NCCI	<p><i>Two-way protocol</i> Enter NCCI to indicate the timers are operating company-specific CCITT7 timers used when the NCCI7 protocol is packaged on the DMS-100 switch.</p>
	NCCIT1	1 to 60	<p><i>Release complete message timer</i> Enter the time, in seconds, during which the release complete message (RCM) must be received after the release (RLS) message is sent.</p> <p>The timer starts when the RLS message is sent and stops when the RCM is received.</p> <p>When the timer expires, the RLS message is repeated and the timer is reinitialized.</p> <p>The default value is 15 (15 s).</p>
	NCCIT2	1 to 240	<p><i>User suspend message timer</i> Enter the time, in seconds, in which a call can be resumed after the user suspend message is sent.</p> <p>The timer starts when the controlling switch receives the suspend (user) message and stops on receipt of the resume (user) message at the controlling switch.</p> <p>When the timer expires, the call is released.</p> <p>The default value is 180 (180 s).</p>

## C7UPTMR signaling protocol NCCI (continued)

### Field descriptions for conditional datafill (Sheet 2 of 6)

Field	Subfield or refinement	Entry	Explanation and action
	NCCITA	1 to 180	<p><i>Release complete message timer</i> Enter the time, in seconds, between sending of the RLS message and the receipt of the RCM.</p> <p>When the timer expires, send a reset circuit (RSC) message, alert maintenance personnel, and remove the circuit from service.</p> <p>The timer starts when the initial RLS message is sent and stops when RCM is received.</p> <p>The default value is 60 (60 s).</p>
	NCCITP	1 to 240	<p><i>Call resume timer</i> Enter the time, in seconds, in which a call can be resumed after a network suspend message is sent.</p> <p>The timer starts when the controlling switch receives suspend (network) message and stops when a resume (network) message is received at the controlling switch.</p> <p>When the timer expires, the circuit is released.</p> <p>The default value is 90 (90 s).</p>
	NCCITE	1 to 60	<p><i>Address complete message timer</i> Enter the time, in seconds, between the sending of the address message and the receipt of an address complete message (ACM). This ensures that the conditions for normal release of address and routing information are met.</p> <p>The timer starts when the latest address message is sent and stops when an ACM is received.</p> <p>When the timer expires, all equipment and connections are released.</p> <p>The default value is 20 (20 s).</p>

## C7UPTMR signaling protocol NCCI (continued)

### Field descriptions for conditional datafill (Sheet 3 of 6)

Field	Subfield or refinement	Entry	Explanation and action
	NCCITF	1 to 60	<p><i>Continuity message timer</i> Enter the time, in seconds, between a transit or an international switch receiving an initial address message (IAM) and the receipt of a continuity message.</p> <p>The timer starts when a transit or incoming international switch receives an IAM and stops when a continuity message is received.</p> <p>When the timer expires, all equipment and connections to the national network are released.</p> <p>The default value is 15 (15 s).</p>
	NCCITK	1 to 60	<p><i>Blocking acknowledgement message timer (first attempt)</i> Enter the time allowed, in seconds, between the sending of the first blocking (BLO) message and the receipt of the blocking acknowledgement (BLA) message.</p> <p>The timer starts when the BLO message is sent and stops on receipt of the BLA message.</p> <p>When the timer expires, the BLO message is repeated and the timer is reinitialized.</p> <p>The default value is 10 (10 s).</p>
	NCCITB	1 to 180	<p><i>Blocking acknowledgement message timer (second attempt)</i> Enter the time allowed, in seconds, between the second or repeated sending of a BLO message and the receipt of a BLA message.</p> <p>The timer starts when the initial BLO message is sent and stops when the BLA message is received.</p> <p>When the timer expires, alert maintenance personnel of the non-receipt of the BLA message and repeat the BLO message at 1-min intervals.</p> <p>The default value is 60 (60 s).</p>

**C7UPTMR signaling protocol NCCI** (continued)

## Field descriptions for conditional datafill (Sheet 4 of 6)

Field	Subfield or refinement	Entry	Explanation and action
	NCCITL	1 to 60	<p><i>Unblocking acknowledgement message timer (first attempt)</i> Enter the time allowed, in seconds, between the sending of the first unblocking (UBL) message and the receipt of the unblocking acknowledgement (UBA) message.</p> <p>The timer starts when the UBL message is sent and stops on receipt of the UBA message.</p> <p>When the timer expires, the UBL message is repeated and the timer is reinitialized.</p> <p>The default value is 10 (10 s).</p>
	NCCITC	1 to 180	<p><i>Unblocking acknowledgement message timer (second attempt)</i> Enter the time allowed, in seconds, between the second or repeated sending of a UBL message and the receipt of a UBA message.</p> <p>The timer starts when the initial UBL message is sent and stops when the UBA message is received.</p> <p>When the timer expires, alert maintenance personnel of the non-receipt of the UBA message and repeat the UBL message at 1-min intervals.</p> <p>The default value is 60 (60 s).</p>
	NCCITI	1 to 60	<p><i>Release complete message timer (first attempt)</i> Enter the time allowed, in seconds, between the sending of a RSC message and the receipt of the RCM.</p> <p>The timer starts when the RSC message is sent and stops when an RCM is received.</p> <p>When the timer expires, repeat the RSC message.</p> <p>The default value is 10 (10 s).</p>

---

**C7UPTMR signaling protocol NCCI** (continued)

---

**Field descriptions for conditional datafill (Sheet 5 of 6)**

Field	Subfield or refinement	Entry	Explanation and action
	NCCITJ	1 to 180	<p><i>Release complete message timer (second attempt)</i></p> <p>Enter the time allowed, in seconds, between the second or repeated sending of an RSC message and the receipt of an RCM.</p> <p>The timer starts when the initial RSC message is sent and stops when the RCM is received.</p> <p>When the timer expires, alert maintenance personnel of the non-receipt of the RCM and repeat the RSC message at 1-min intervals.</p> <p>The default value is 60 (60 s).</p>
	NCCITN	1 to 60	<p><i>Group release complete message timer (first attempt)</i></p> <p>Enter the time allowed, in seconds, between the sending of a group reset circuit message and the receipt of a group release complete message.</p> <p>The timer starts when the RSC message is sent and stops when an RCM is received.</p> <p>When the timer expires, repeat the group reset circuit message.</p> <p>The default value is 10 (10 s).</p>

---

**C7UPTMR signaling protocol NCCI** (continued)
 

---

**Field descriptions for conditional datafill (Sheet 6 of 6)**

Field	Subfield or refinement	Entry	Explanation and action
	NCCITO	1 to 180	<p><i>Group release complete message timer (second attempt)</i></p> <p>Enter the time allowed, in seconds, between the second or repeated sending of a group reset circuit message and the receipt of a group release circuit message.</p> <p>The timer starts when the initial group reset circuit message is sent and stops when the group release circuit message is received.</p> <p>When the timer expires, alert maintenance personnel of the non-receipt of the group release circuit message and repeat the group reset circuit at 1-min intervals.</p> <p>The default value is 60 (60 s).</p>
OPTIONS (BCS36-)		\$	<p><i>Timer options list</i></p> <p>No refinements defined. Enter \$.</p>

---

**C7UPTMR signaling protocol NCCI (continued)**

---

**C7UPDIR = IC**

If the entry in subfield C7UPDIR is IC, datafill subfield ICPROT and refinements as described below, then datafill field OPTIONS.

**Field descriptions for conditional datafill (Sheet 1 of 5)**

Field	Subfield or refinement	Entry	Explanation and action
	ICPROT	NCCI	<i>Incoming protocol</i> Enter NCCI to indicate the timers are operating company-specific CCITT7 timers used when the NCCI7 protocol is packaged on the DMS-100 switch.
	NCCIT1	1 to 60	<i>Release complete message timer</i> Enter the time, in seconds, during which the release complete message (RCM) must be received after the release (RLS) message is sent.  The timer starts when the RLS message is sent and stops when the RCM message is received.  When the timer expires, the RLS message is repeated and the timer is reinitialized.  The default value is 15 (15 s).
	NCCITT2	1 to 240	<i>User suspend message timer</i> Enter the time, in seconds, in which a call can be resumed after the user suspend (SUS) message is sent.  The timer starts when the controlling switch receives the SUS message and stops on receipt of the resume (user) (RES) message at the controlling switch.  When the timer expires, the call is released.  The default value is 180 (180 s).



**C7UPTMR signaling protocol NCCI** (continued)

## Field descriptions for conditional datafill (Sheet 2 of 5)

Field	Subfield or refinement	Entry	Explanation and action
	NCCITA	1 to 180	<p><i>Release complete message timer</i> Enter the time, in seconds, between sending of the RLS message and the receipt of the RCM.</p> <p>When the timer expires, send an RSC message, alert maintenance personnel, and remove the circuit from service.</p> <p>The timer starts when the initial RLS message is sent and stops when an RCM is received.</p> <p>The default value is 60 (60 s).</p>
	NCCITP	1 to 240	<p><i>Call resume timer</i> Enter the time, in seconds, in which a call can be resumed after a network suspend message is sent.</p> <p>The timer starts when the controlling switch receives suspend (network) message and stops when a resume (network) message is received at the controlling switch.</p> <p>When the timer expires, the circuit is released.</p> <p>The default value is 90 (90 s).</p>
	NCCITF	1 to 60	<p><i>Continuity message timer</i> Enter the time, in seconds, between a transit or an international switch receiving an initial address message (IAM) and the receipt of a continuity message.</p> <p>The timer starts when a transit or incoming international switch receives an initial address message and stops when a continuity message is received.</p> <p>When the timer expires, all equipment and connections to the national network are released.</p> <p>The default value is 15 (15 s).</p>

## C7UPTMR signaling protocol NCCI (continued)

### Field descriptions for conditional datafill (Sheet 3 of 5)

Field	Subfield or refinement	Entry	Explanation and action
	NCCITK	1 to 60	<p><i>Blocking acknowledgement message timer (first attempt)</i> Enter the time allowed, in seconds, between the sending of the first blocking (BLO) message and the receipt of blocking acknowledgement (BLA) message.</p> <p>The timer starts when a BLO message is sent and stops on receipt of the BLA message.</p> <p>When the timer expires, the BLO message is repeated and the timer is reinitialized.</p> <p>The default value is 10 (10 s).</p>
	NCCITB	1 to 180	<p><i>Blocking acknowledgement message timer (second attempt)</i> Enter the time allowed, in seconds, between the second or repeated sending of a BLO message and the receipt of a BLA message.</p> <p>The timer starts when the initial BLO message is sent and stops when the BLA message is received.</p> <p>When the timer expires, alert maintenance personnel of the non-receipt of the BLA message and repeat the BLO message at 1-min intervals.</p> <p>The default value is 60 (60 s).</p>
	NCCITL	1 to 60	<p><i>Unblocking acknowledgement message timer (first attempt)</i> Enter the time allowed, in seconds, between the sending of the first unblocking (UBL) message and the receipt of the unblocking acknowledgement (UBA) message.</p> <p>The timer starts when the UBL message is sent and stops on receipt of the UBA message.</p> <p>When the timer expires, the UBL message is repeated and the timer is reinitialized.</p> <p>The default value is 10 (10 s).</p>

**C7UPTMR signaling protocol NCCI** (continued)

## Field descriptions for conditional datafill (Sheet 4 of 5)

Field	Subfield or refinement	Entry	Explanation and action
	NCCITC	1 to 180	<p><i>Unblocking acknowledgement message timer (second attempt)</i> Enter the time allowed, in seconds, between the second or repeated sending of an UBL message and the receipt of a UBA message.</p> <p>The timer starts when the initial UBL message is sent and stops when the UBA message is received.</p> <p>When the timer expires, alert maintenance personnel of the non-receipt of the UBA message and repeat the UBL message at 1-min intervals.</p> <p>The default value is 60 (60 s).</p>
	NCCITI	1 to 60	<p><i>Release complete message timer (first attempt)</i> Enter the time allowed, in seconds, between the sending of a reset circuit (RSC) message and the receipt of an RCM.</p> <p>The timer starts when an RSC message is sent and stops when an RCM is received.</p> <p>When the timer expires, repeat the RSC message.</p> <p>The default value is 10 (10 s).</p>
	NCCITJ	1 to 180	<p><i>Release complete message timer (second attempt)</i> Enter the time allowed, in seconds, between the second or repeated sending of an RSC message and the receipt of an RCM.</p> <p>The timer starts when the initial RSC message is sent and stops when the RCM is received.</p> <p>When the timer expires, alert maintenance personnel of the non-receipt of an RCM and repeat the RSC message at 1-min intervals.</p> <p>The default value is 60 (60 s).</p>

---

**C7UPTMR signaling protocol NCCI** (continued)

---

**Field descriptions for conditional datafill (Sheet 5 of 5)**

Field	Subfield or refinement	Entry	Explanation and action
	NCCITN	1 to 60	<p><i>Group release complete message timer (first attempt)</i> Enter the time allowed, in seconds, between the sending of a group RSC message and the receipt of a group RCM.</p> <p>The timer starts when an RSC message is sent and stops when an RCM is received.</p> <p>When the timer expires, repeat the group RSC message.</p> <p>The default value is 10 (10 s).</p>
	NCCITO	1 to 180	<p><i>Group release complete message timer (second attempt)</i> Enter the time allowed, in seconds, between the second or repeated sending of a group RSC message and the receipt of a group RCM.</p> <p>The timer starts when the initial group RSC message is sent and stops when the group RCM is received.</p> <p>When the timer expires, alert maintenance personnel of the non-receipt of the group RCM and repeat the group RSC message at 1-min intervals.</p> <p>The default value is 60 (60 s).</p>
OPTIONS (BCS36-)		\$	<p><i>Timer options list</i> No refinements defined. Enter \$.</p>

## C7UPTMR signaling protocol NCCI (continued)

### C7UPDIR = OG

If the entry subfield C7UPDIR is OG, datafill subfield OGPROT and refinements as described below, then datafill field OPTIONS.

#### Field descriptions for conditional datafill (Sheet 1 of 5)

Field	Subfield or refinement	Entry	Explanation and action
	OGPROT	NCCI	<p><i>Outgoing protocol</i> Enter NCCI to indicate the timers are operating company-specific CCITT7 timers used when the NCCI7 protocol is packaged on the DMS-100 switch.</p>
	NCCIT1	1 to 60	<p><i>Release complete message timer</i> Enter the time, in seconds, during which the release complete message (RCM) must be received after the release (RLS) message is sent.</p> <p>The timer starts when the RLS message is sent and stops when the RCM message is received.</p> <p>When the timer expires, the RLS message is repeated and the timer is reinitialized.</p> <p>The default value is 15 (15 s).</p>
	NCCIT2	1 to 240	<p><i>User suspend message timer</i> Enter the time, in seconds, in which a call can be resumed after the user suspend message is sent.</p> <p>The timer starts when the controlling switch receives the suspend (user) message and stops when the resume (user) message is received at the controlling switch.</p> <p>When the timer expires, the call is released.</p> <p>The default value is 180 (180 s).</p>

---

**C7UPTMR signaling protocol NCCI** (continued)

---

**Field descriptions for conditional datafill (Sheet 2 of 5)**

Field	Subfield or refinement	Entry	Explanation and action
	NCCITA	1 to 180	<p><i>Release complete message timer</i> Enter the time, in seconds, between sending of the RLS message and the receipt of the RLC message.</p> <p>When the timer expires, send the reset circuit (RSC) message, alert maintenance personnel, and remove the circuit from service.</p> <p>The timer starts when the initial RLS message is sent and stops when RCM is received.</p> <p>The default value is 60 (60 s).</p>
	NCCITP	1 to 240	<p><i>Call resume timer</i> Enter the time, in seconds, in which a call can be resumed after a network suspend message is sent.</p> <p>The timer starts when the controlling switch receives suspend (network) message and stops when a resume (network) message is received at the controlling switch.</p> <p>When the timer expires, the circuit is released.</p> <p>The default value is 90 (90 s).</p>
	NCCITE	1 to 60	<p><i>Address complete message timer</i> Enter the time, in seconds, between the sending of the address message and the receipt of an address complete message (ACM). This ensures that the conditions for normal release of address and routing information are met.</p> <p>The timer starts when the latest address message is sent and stops when an ACM is received.</p> <p>When the timer expires, all equipment and connections are released.</p> <p>The default value is 20 (20 s).</p>

**C7UPTMR signaling protocol NCCI** (continued)

## Field descriptions for conditional datafill (Sheet 3 of 5)

Field	Subfield or refinement	Entry	Explanation and action
	NCCITK	1 to 60	<p><i>Blocking acknowledgement message timer (first attempt)</i> Enter the time allowed, in seconds, between the sending of the first blocking (BLO) message and the receipt of blocking acknowledgement (BLA) message.</p> <p>The timer starts when a BLO message is sent and stops on receipt of the BLA message.</p> <p>When the timer expires, the BLO message is repeated and the timer is reinitialized.</p> <p>The default value is 10 (10 s).</p>
	NCCITB	1 to 180	<p><i>Blocking acknowledgement message timer (second attempt)</i> Enter the time allowed, in seconds, between the second or repeated sending of a BLO message and the receipt of a BLA message.</p> <p>The timer starts when the initial BLO message is sent and stops when the BLA message is received.</p> <p>When the timer expires, alert maintenance personnel of the non-receipt of the BLA message and repeat the BLO message at 1-min intervals.</p> <p>The default value is 60 (60 s).</p>
	NCCITL	1 to 60	<p><i>Unblocking acknowledgement message timer (first attempt)</i> Enter the time allowed, in seconds, between the sending of the first unblocking (UBL) message and the receipt of the unblocking acknowledgement (UBA) message.</p> <p>The timer starts when the UBL message is sent and stops on receipt of the UBA message.</p> <p>When the timer expires, the UBL message is repeated and the timer is reinitialized.</p> <p>The default value is 10 (10 s).</p>

## C7UPTMR signaling protocol NCCI (continued)

### Field descriptions for conditional datafill (Sheet 4 of 5)

Field	Subfield or refinement	Entry	Explanation and action
	NCCITC	1 to 180	<p><i>Unblocking acknowledgement message timer (second attempt)</i> Enter the time allowed, in seconds, between the second or repeated sending of a UBL message and the receipt of a UBA message.</p> <p>The timer starts when the initial UBL message is sent and stops when the UBA message is received.</p> <p>When the timer expires, alert maintenance personnel of the non-receipt of the UBA message and repeat the UBL message at 1-min intervals.</p> <p>The default value is 60 (60 s).</p>
	NCCITI	1 to 60	<p><i>Release complete message timer (first attempt)</i> Enter the time allowed, in seconds, between the sending of an RSC message and the receipt of the RCM.</p> <p>The timer starts when the RSC message is sent and stops when an RCM is received.</p> <p>When the timer expires, repeat the RSC message.</p> <p>The default value is 10 (10 s).</p>
	NCCITJ	1 to 180	<p><i>Release complete message timer (second attempt)</i> Enter the time allowed, in seconds, between the second or repeated sending of an RSC message and the receipt of an RCM.</p> <p>The timer starts when the initial RSC message is sent and stops when the RCM message is received.</p> <p>When the timer expires, alert maintenance personnel of the non-receipt of the RCM and repeat the RSC message at 1-min intervals.</p> <p>The default value is 60 (60 s).</p>



**C7UPTMR signaling protocol NCCI** (continued)

## Field descriptions for conditional datafill (Sheet 5 of 5)

Field	Subfield or refinement	Entry	Explanation and action
	NCCITN	1 to 60	<p><i>Group release complete message timer (first attempt)</i> Enter the time allowed, in seconds, between the sending of a group reset circuit message and the receipt of a group release complete message.</p> <p>The timer starts when the RSC message is sent and stops when an RCM is received.</p> <p>When the timer expires, repeat the group reset circuit message.</p> <p>The default value is 10 (10 s).</p>
	NCCITO	1 to 180	<p><i>Group release complete message timer (second attempt)</i> Enter the time allowed, in seconds, between the second or repeated sending of a group reset circuit message and the receipt of a group release circuit message.</p> <p>The timer starts when the initial group reset circuit message is sent and stops when the group release circuit message is received.</p> <p>When the timer expires, alert maintenance personnel of the non-receipt of the group release circuit message and repeat the group reset circuit at 1-min intervals.</p> <p>The default value is 60 (60 s).</p>
OPTIONS (BCS36-)		\$	<p><i>Timer options list</i> No refinements defined. Enter \$.</p>

**Datafill example**

The following example shows sample datafill for table C7UPTMR signaling protocol NCCI.



## C7UPTMR signaling protocol Q764

---

### American National Standards Institute

Signaling protocol Q764 is used for American National Standards Institute (ANSI) ISUP.

### Datafill

The following table lists the datafill for table C7UPTMR signaling protocol Q764.

### Field descriptions

Field	Subfield or refinement	Entry	Explanation and action
	PROT	see subfields	<i>Protocol</i> If the entry in field C7UPDIR is 2W, this subfield consists of subfield BWPROT.  If the entry in field C7UPDIR is IC, this subfield consists of subfield ICPROT.  If the entry in field C7UPDIR is OG, this subfield consists of subfield OGPROT.

---

**C7UPTMR signaling protocol Q764** (continued)

---

**C7UPDIR = 2W**

If the entry subfield C7UPDIR is 2W, datafill subfield BWPROT and refinements as described below, then datafill field OPTIONS.

**Field descriptions for conditional datafill (Sheet 1 of 7)**

Field	Subfield or refinement	Entry	Explanation and action
	BWPROT	Q764	<p><i>Two-way protocol</i> Enter Q764 to indicate that the timers are American National Standards Institute 7 (ANSI7) ISUP timers.</p> <p><b>Note:</b> If Q764 timers are used with fields PROT or BWPROT, only basic call setup and maintenance are supported. As of BCS31, feature package NTXE66 (CCS7 ISUP Option Controls) is required in order to modify Q764 timer values. Prior to BCS31, table C7UPTMR was visible if feature package NTX167 (CCS7 - Trunk Signaling) was present, and Q764 timer values could be modified. However, these new values were not downloaded to the extended multiprocessor system (XMS)-based peripheral module (XPM) and the default values continued to be used.</p>
	COT	10 to 15	<p><i>Continuity timer</i> Enter the time, in seconds, to wait for a continuity (COT) or release (REL) message after responding to a COT test request in the initial address message (IAM).</p> <p>The timer starts when a COT test request is received in the IAM and stops when a COT or REL message is received.</p> <p>When the timer expires, a reset circuit (RSC) message is sent.</p> <p>The default value is 13 (13 s).</p>

## C7UPTMR signaling protocol Q764 (continued)

### Field descriptions for conditional datafill (Sheet 2 of 7)

Field	Subfield or refinement	Entry	Explanation and action
	TONE	2	<p><i>Tone timer</i> Enter the time, 2 s, to wait for the reception of a suitable tone and its removal from the far end, after requesting a continuity check in an IAM.</p> <p>The timer starts when the request for a continuity check is sent and stops when a suitable tone is received and removed.</p> <p>When the timer expires, an RSC message is sent.</p> <p>The default value is 2 (2 s).</p>
	ACM	20 to 30	<p><i>Address complete timer</i> Enter the time, in seconds, to wait for an address complete message (ACM), an answer message (ANM), or an REL message after sending an IAM.</p> <p>The timer starts when IAM is sent and stops on receipt of an ACM, ANM, or an REL message.</p> <p>When the timer expires, the call is routed to reorder tone.</p> <p>The default value is 25 (25 s).</p>
	RLCSREL	4 to 15	<p><i>Release complete after sending release short timer</i> Enter the time, in seconds, to wait for a release complete (RLC) message after sending an REL message. When an REL message is sent, timers RLCSREL and RLCLREL start and wait for an RLC message. If no RLC message is received by the time timer RLCSREL expires, a second REL message is sent and timer RLCSREL is reset. This process continues until timer RLCLREL expires.</p> <p>The timer starts when an REL message is sent and stops on receipt of an RLC message.</p> <p>The default value is 6 (6 s).</p>

## C7UPTMR signaling protocol Q764 (continued)

### Field descriptions for conditional datafill (Sheet 3 of 7)

Field	Subfield or refinement	Entry	Explanation and action
	RLCLREL	60	<p><i>Release complete after sending release long timer</i></p> <p>Enter the time, 60 s, to wait for an RLC message after sending an REL message. When the REL message is sent, timers RLCSREL and RLCLREL start and wait for an RLC message. If no RLC message is received by the time timer RLCSREL expires, a second REL message is sent and timer RLCSREL is reset. This process continues until timer RLCLREL expires.</p> <p>The timer starts when the first REL message is sent and stops when an RLC message is received.</p> <p>When the timer expires:</p> <p>An RSC message is sent to the far end.</p> <ul style="list-style-type: none"> <li>• A log is produced to notify the maintenance personnel.</li> <li>• The sending of REL messages stops.</li> <li>• The circuit is removed from service.</li> <li>• Additional RSC messages are sent at 1 min intervals until a RLC message is received or until maintenance intervenes.</li> </ul> <p>The default value is 60 (60 s).</p>
	IRETEST	1 to 10	<p><i>Initial retest timer</i></p> <p>Enter the time, in seconds, to wait before sending a continuity check request (CCR) message after receiving the first continuity test failure.</p> <p>The timer starts when the first continuity test failure is received and stops when a CCR message is sent.</p> <p>When the timer expires, a CCR message is sent.</p> <p>The default value is 10 (10 s).</p>

## C7UPTMR signaling protocol Q764 (continued)

### Field descriptions for conditional datafill (Sheet 4 of 7)

Field	Subfield or refinement	Entry	Explanation and action
	SRETEST	60 to 180	<p><i>Subsequent retest timer</i> Enter the time, in seconds, to wait before sending a CCR message after receiving a subsequent continuity test failure.</p> <p>The timer starts when the subsequent continuity test failure is received and stops when a CCR message is sent.</p> <p>When the timer expires, a CCR message is sent and a log is produced to notify the maintenance personnel.</p> <p>The default value is 180 (180 s).</p>
	ICCR	16 to 20	<p><i>Initial continuity check request message timer</i> Enter the time allowed, in seconds, after the first continuity test failure is detected and the CCR message is received.</p> <p>The timer starts when continuity check failure is detected and stops when a CCR message is received.</p> <p>When the timer expires, an RSC message is sent.</p> <p>The default value is 20 (20 s).</p>
	SCCR	180 to 300	<p><i>Subsequent continuity check request message timer</i> Enter the time allowed, in seconds, after the second continuity check failure is detected and the CCR message is received.</p> <p>The timer starts when the second continuity check failure is detected and stops when a CCR is received.</p> <p>When the timer expires, an RSC message is sent.</p> <p>The default value is 200 (200 s).</p>

---

**C7UPTMR signaling protocol Q764** (continued)

---

**Field descriptions for conditional datafill (Sheet 5 of 7)**

Field	Subfield or refinement	Entry	Explanation and action
	RLCSRSC	4 to 15	<p><i>Release complete after sending reset circuit short timer</i></p> <p>Enter the time, in seconds, to wait for the RLC message after sending an RSC message. When an RSC message is sent, timers RLCSRSC and RLCLRSC start and wait for an RLC message. If no RLC message is received by the time timer RLCSRSC expires, a second RSC message is sent and timer RLCSRSC is reset. This process continues until timer RLCLRSC expires.</p> <p>The timer starts when the RSC message is sent and stops on receipt of an RLC message.</p> <p>The default value is 13 (13 s).</p>
	RLCLRSC	60	<p><i>Release complete after sending reset circuit long timer</i></p> <p>Enter the time, 60 s, to wait for the RLC message after sending an RSC message. When an RSC message is sent, two timers RLCSRSC and RLCLRSC start and wait for an RLC message. If no RLC message is received by the time timer RLCSRSC expires, a second RSC message is sent and timer RLCSRSC is reset. This process continues until timer RLCLRSC expires.</p> <p>The timer starts when the first RSC message is sent and stops when an RLC message is received.</p> <p>When the timer expires, a log is produced to notify the maintenance personnel.</p> <p>The default value is 60 (60 s).</p>



## C7UPTMR signaling protocol Q764 (continued)

### Field descriptions for conditional datafill (Sheet 6 of 7)

Field	Subfield or refinement	Entry	Explanation and action
	LPA	2	<p><i>Loopback acknowledgement timer</i> Enter the time, 2 s, to wait for receipt of a loopback acknowledgement (LPA) message after sending a CCR message.</p> <p>The timer starts when the CCR message is sent and stops on receipt of the LPA message.</p> <p>When the timer expires, the central control (CC), computing module (CM), or message switch (MS) is informed that COT failed and a COT message indicating "continuity check failed" is sent to the far end. After timer SRETEST expires, another continuity test is performed.</p> <p>The default value is 2 (2 s).</p>
	EXM	30 to 40	<p><i>Exit message timer</i> This is an ISUP equal access timer. Enter the time, in seconds, to wait for an exit message (EXM) after sending an IAM.</p> <p>The timer starts when the IAM is sent and stops on receipt of an EXM. When the timer expires, the call is routed to reorder tone.</p> <p>The default value is 32 (32 s).</p>
	CRM	3 to 4	<p><i>Circuit reservation message timer</i> This is an ISUP equal access timer. Enter the time, in seconds, to wait for a circuit reservation acknowledge (CRA) message after sending a circuit reservation message (CRM) .</p> <p>The timer starts when a CRM is sent and stops on receipt of a CRA message.</p> <p>When the timer expires, a failure message is sent to the CC, the timer is reset, and another attempt is made.</p> <p>The default value is 3 (3 s).</p>

## C7UPTMR signaling protocol Q764 (continued)

### Field descriptions for conditional datafill (Sheet 7 of 7)

Field	Subfield or refinement	Entry	Explanation and action
	WEXD	0 to 1200	<p><i>Exit message delay timer</i> This timer is an ISUP equal access timer. Enter the time, in milliseconds, to delay the sending of the exit message (EXM) to synchronize the sending of the IAM forward and the sending of the EXM backward.</p> <p>The timer starts when the IAM is sent forward.</p> <p>When the timer expires, the EXM is sent backward.</p> <p>The default value is 600 (600 ms).</p>
OPTIONS (BCS36-)		See subfields	<p><i>Timer options list</i> Enter OPTION and datafill its subfields.</p>
	OPTION	MCD	<p><i>Option</i> Enter MCD for Minimum Call Duration and datafill subfield MCD_TIMER.</p> <p>Enter \$ if no refinements have been defined.</p>
	MCD_TIMER	0 to 700	<p>Enter the time, in 10 ms units, between receiving an answer (ANS) message and sending a release message (REL).</p> <p>The MCD timer starts after an ANM message is received and stops after a REL message is sent.</p> <p>If a suspend (SUS) message is received while the MCD timer is active, a disconnect time is set and a REL message is sent when the timer expires.</p> <p>If a resume (RES) message is received before the MCD timer expires, the timer will be cleared and a REL message will not be sent.</p> <p>A value other than 0 must be entered in order to activate the timer.</p> <p>The default value is 0.</p>

---

**C7UPTMR signaling protocol Q764** (continued)
 

---

**C7UPDIR = IC**

If the entry in subfield C7UPDIR is IC, datafill subfield ICPROT and refinements as described below, then datafill field OPTIONS.

**Field descriptions for conditional datafill (Sheet 1 of 5)**

Field	Subfield or refinement	Entry	Explanation and action
	ICPROT	Q764	<p><i>Incoming protocol</i> Enter Q764 to indicate that the timers are American National Standards Institute 7 (ANSI7) ISUP timers.</p> <p><b>Note:</b> If Q764 timers are used with fields PROT or BWPROT, only basic call setup and maintenance are supported. As of BCS31, feature package NTXE66 (CCS7 ISUP Option Controls) is required in order to modify Q764 timer values. Prior to BCS31, table C7UPTMR was visible if feature package NTX167 (CCS7—Trunk Signaling) was present, and Q764 timer values could be modified. However, these new values were not downloaded to the extended multiprocessor system (XMS)-based peripheral module (XPM) and the default values continued to be used.</p>
	COT	10 to 15	<p><i>Continuity timer</i> Enter the time, in seconds, to wait for a continuity (COT) or release (REL) message after responding to a continuity test request in the initial address message (IAM).</p> <p>The timer starts when a continuity test request is received in the IAM and stops when a continuity message is received. When the timer expires, a reset circuit (RSC) message is sent.</p> <p>The default value is 13 (13 s).</p>

---

**C7UPTMR signaling protocol Q764** (continued)
 

---

**Field descriptions for conditional datafill (Sheet 2 of 5)**

Field	Subfield or refinement	Entry	Explanation and action
	RLCSREL	4 to 15	<p><i>Release complete after sending release short timer</i></p> <p>Enter the time, in seconds, to wait for a release complete (RLC) message after sending an REL message. When an REL message is sent, timers RLCSREL and RLCLREL start and wait for an RLC message. If no RLC message is received by the time timer RLCSREL expires, a second REL message is sent and timer RLCSREL is reset. This process continues until timer RLCLREL expires.</p> <p>The timer starts when an REL message is sent and stops on receipt of an RLC message.</p> <p>The default value is 6 (6 s).</p>

## C7UPTMR signaling protocol Q764 (continued)

### Field descriptions for conditional datafill (Sheet 3 of 5)

Field	Subfield or refinement	Entry	Explanation and action
	RLCLREL	60	<p><i>Release complete after sending release long timer</i></p> <p>Enter the time, 60 s, to wait for an RLC message after sending an REL message. When an REL message is sent, timers RLCSREL and RLCLREL start and wait for an RLC message. If no RLC message is received by the time timer RLCSREL expires, a second REL is sent and timer RLCSREL is reset. This process continues until timer RLCLREL expires.</p> <p>The timer starts when the first REL message is sent and stops when an RLC message is received.</p> <p>When the timer expires</p> <ul style="list-style-type: none"> <li>• An RSC message is sent to the far end.</li> <li>• A log is produced to notify the maintenance personnel.</li> <li>• The sending of REL messages stops.</li> <li>• The circuit is removed from service.</li> <li>• Additional RSC messages are sent at 1 min intervals until an RLC message is received or until maintenance intervenes.</li> </ul> <p>The default value is 60 (60 s).</p>
	ICCR	16 to 20	<p><i>Initial continuity check request message timer</i></p> <p>Enter the time allowed, in seconds, after the first continuity test failure is detected and the continuity check request (CCR) message is received.</p> <p>The timer starts when continuity check failure is detected and stops when a CCR message is received.</p> <p>When the timer expires, an RSC message is sent.</p> <p>The default value is 20 (20 s).</p>

---

**C7UPTMR signaling protocol Q764** (continued)

---

**Field descriptions for conditional datafill (Sheet 4 of 5)**

Field	Subfield or refinement	Entry	Explanation and action
	SCCR	180 to 300	<p><i>Subsequent continuity check request message timer</i></p> <p>Enter the time allowed, in seconds, after the second continuity check failure is detected and the CCR message is received.</p> <p>The timer starts when the second continuity check failure is detected and stops when a CCR message is received.</p> <p>When the timer expires, an RSC message is sent.</p> <p>The default value is 200 (200 s).</p>
	RLCSRSC	4 to 15	<p><i>Release complete after sending reset circuit short timer</i></p> <p>Enter the time, in seconds, to wait for the RLC message after sending an RSC message. When an RSC message is sent, timers RLCSRSC and RLCLRSC start and wait for an RLC message. If no RLC message is received by the time timer RLCSRSC expires, a second RSC message is sent and timer RLCSRSC is reset. This process continues until timer RLCLRSC expires.</p> <p>The timer starts when the RSC message is sent and stops on receipt of the RLC message.</p> <p>The default value is 13 (13 s).</p>

## C7UPTMR signaling protocol Q764 (continued)

### Field descriptions for conditional datafill (Sheet 5 of 5)

Field	Subfield or refinement	Entry	Explanation and action
	RLCLRSC	60	<p><i>Release complete after sending reset circuit long timer</i></p> <p>Enter the time, 60 s, to wait for the RLC message after sending an RSC message. When the RSC message is sent, timers RLCSRSC and RLCLRSC start and wait for an RLC message. If no RLC message is received by the time timer RLCSRSC expires, a second RSC message is sent and timer RLCSRSC is reset. This process continues until timer RLCLRSC expires.</p> <p>The timer starts when the first RSC message is sent and stops when an RLC message is received.</p> <p>When the timer expires, a log is produced to notify the maintenance personnel.</p> <p>The default value is 60 (60 s).</p>
	WEXD	0 to 1200	<p><i>Exit message delay timer</i></p> <p>This timer is an ISUP equal access timer.</p> <p>Enter the time, in milliseconds, to delay the sending of the exit message (EXM) to synchronize the sending of the IAM forward and the sending of the EXM backward.</p> <p>The timer starts when the IAM is sent forward.</p> <p>When the timer expires, the EXM is sent backward.</p> <p>The default value is 600 (600 ms).</p>
OPTIONS (BCS36-)		\$	<p><i>Timer options list</i></p> <p>No refinements defined. Enter \$.</p>

---

**C7UPTMR signaling protocol Q764** (continued)

---

**C7UPDIR = OG**

If the entry subfield C7UPDIR is OG, datafill subfield OGPROT and refinements as described below, then datafill field OPTIONS.

**Field descriptions for conditional datafill (Sheet 1 of 7)**

Field	Subfield or refinement	Entry	Explanation and action
	OGPROT	Q764	<p><i>Outgoing protocol</i> Enter Q764 to indicate that the timers are American National Standards Institute 7 (ANSI7) ISUP timers.</p> <p><b>Note:</b> If Q764 timers are used with fields PROT or BWPROT, only basic call setup and maintenance are supported. As of BCS31, feature package NTXE66 (CCS7 ISUP Option Controls) is required in order to modify Q764 timer values. Prior to BCS31, table C7UPTMR was visible if feature package NTX167 (CCS7—Trunk Signaling) was present, and Q764 timer values could be modified. However, these new values were not downloaded to the extended multiprocessor system (XMS)-based peripheral module (XPM) and the default values continued to be used.</p>
	TONE	2	<p><i>Tone timer</i> Enter the time, 2 s, to wait for the reception of a suitable tone and its removal from the far end, after requesting a continuity check in an initial address message (IAM).</p> <p>The timer starts when the request for a continuity check is sent and stops when a suitable tone is received and removed. When the timer expires, a reset circuit (RSC) message is sent.</p> <p>The default value is 2 (2 s).</p>



## C7UPTMR signaling protocol Q764 (continued)

### Field descriptions for conditional datafill (Sheet 2 of 7)

Field	Subfield or refinement	Entry	Explanation and action
	ACM	20 to 30	<p><i>Address complete timer</i> Enter the time, in seconds, to wait for an address complete message (ACM), an answer message (ANM), or a release message (REL), after sending an IAM.</p> <p>The timer starts when IAM is sent and stops on receipt of an ACM, ANM, or an REL message.</p> <p>When the timer expires, the call is routed to reorder tone.</p> <p>The default value is 25 (25 s).</p>
	RLCSREL	4 to 15	<p><i>Release complete after sending release short timer</i> Enter the time, in seconds, to wait for a release complete (RLC) message after sending an REL message. When the REL message is sent, timers RLCSREL and RLCLREL start and wait for an RLC message. If no RLC message is received by the time timer RLCSREL expires, a second REL message is sent and timer RLCSREL is reset. This process continues until timer RLCLREL expires.</p> <p>The timer starts when the REL message is sent and stops on receipt of an RLC message.</p> <p>The default value is 6 (6 s).</p>

---

**C7UPTMR signaling protocol Q764** (continued)

---

**Field descriptions for conditional datafill (Sheet 3 of 7)**

Field	Subfield or refinement	Entry	Explanation and action
	RLCLREL	60	<p><i>Release complete after sending release long timer</i></p> <p>Enter the time, 60 s, to wait for an RLC message after sending an REL message.). When the REL message is sent, timers RLCSREL and RLCLREL start and wait for an RLC message. If no RLC message is received by the time timer RLCSREL expires, a second REL message is sent and timer RLCSREL is reset. This process continues until timer RLCLREL expires.</p> <p>The timer starts when the first REL message is sent and stops when an RLC message is received.</p> <p>When the timer expires:</p> <ul style="list-style-type: none"> <li>• An RSC message is sent to the far end.</li> <li>• A log is produced to notify the maintenance personnel.</li> <li>• The sending of REL messages stops.</li> <li>• The circuit is removed from service.</li> <li>• Additional RSC messages are sent at 1 min intervals until an RLC message is received or until maintenance intervenes.</li> </ul> <p>The default value is 60 (60 s).</p>
	IRETEST	1 to 10	<p><i>Initial retest timer</i></p> <p>Enter the time, in seconds, to wait before sending a continuity check request (CCR) message after receiving the first continuity test failure message.</p> <p>The timer starts when the first continuity test failure message is received and stops when a CCR message is sent.</p> <p>When the timer expires, a CCR message is sent.</p> <p>The default value is 10 (10 s).</p>

## C7UPTMR signaling protocol Q764 (continued)

### Field descriptions for conditional datafill (Sheet 4 of 7)

Field	Subfield or refinement	Entry	Explanation and action
	SRETEST	60 to 180	<p><i>Subsequent retest timer</i> Enter the time, in seconds, to wait before sending a CCR message after receiving a subsequent continuity test failure message.</p> <p>The timer starts when the subsequent continuity test failure message is received and stops when a CCR message is sent.</p> <p>When the timer expires, a CCR message is sent and a log is produced to notify the maintenance personnel.</p> <p>The default value is 180 (180 s).</p>
	RLCSRSC	4 to 15	<p><i>Release complete after sending reset circuit short timer</i> Enter the time, in seconds, to wait for the RLC message after sending an RSC message.</p> <p>When an RSC message is sent, timers RLCSRSC and RLCLRSC start and wait for an RLC message. If no RLC message is received by the time timer RLCSRSC expires, a second RSC message is sent and timer RLCSRSC is reset. This process continues until timer RLCLRSC expires.</p> <p>The timer starts when the RSC message is sent and stops on receipt of an RLC message.</p> <p>The default value is 13 (13 s).</p>

---

**C7UPTMR signaling protocol Q764** (continued)

---

## Field descriptions for conditional datafill (Sheet 5 of 7)

Field	Subfield or refinement	Entry	Explanation and action
	RLCLRSC	60	<p><i>Release complete after sending reset circuit long timer</i></p> <p>Enter the time, 60 s, to wait for the RLC message after sending an RSC message. When an RSC message is sent, timers RLCSRSC and RLCLRSC start and wait for an RLC message. If no RLC message is received by the time timer RLCSRSC expires, a second RSC message is sent and timer RLCSRSC is reset. This process continues until timer RLCLRSC expires.</p> <p>The timer starts when the first RSC message is sent and stops when an RLC message is received.</p> <p>When the timer expires, a log is produced to notify the maintenance personnel.</p> <p>The default value is 60 (60 s).</p>
	LPA	2	<p><i>Loopback acknowledgement timer</i></p> <p>Enter the time, 2 s, to wait for receipt of a loopback acknowledge (LPA) message after sending a CCR message.</p> <p>The timer starts when a CCR message is sent and stops on receipt of an LPA message.</p> <p>When the timer expires, the central control (CC), computing module (CM), or message switch (MS) is informed that continuity (COT) failed and a COT message indicating "continuity check failed" is sent to the far end. After timer SRETEST expires, another continuity test is performed.</p> <p>The default value is 2 (2 s).</p>

## C7UPTMR signaling protocol Q764 (continued)

### Field descriptions for conditional datafill (Sheet 6 of 7)

Field	Subfield or refinement	Entry	Explanation and action
	EXM	30 to 40	<p><i>Exit message timer</i> This is an ISUP equal access timer. Enter the time, in seconds, to wait for an exit message (EXM) after sending an IAM.</p> <p>The timer starts when the IAM is sent and stops on receipt of an EXM.</p> <p>When the timer expires, the call is routed to reorder tone.</p> <p>The default value is 32 (32 s).</p>
	CRM	3 to 4	<p><i>Circuit reservation message timer</i> This is an ISUP equal access timer. Enter the time, in seconds, to wait for a circuit reservation acknowledge (CRA) message after sending a circuit reservation message (CRM).</p> <p>The timer starts when a CRM is sent and stops on receipt of a CRA.</p> <p>When the timer expires, a failure message is sent to the CC, the timer is reset, and another attempt is made.</p> <p>The default value is 3 (3 s).</p>
OPTIONS (BCS36-)		See subfields	<p><i>Timer options list</i> Enter OPTION and datafill its subfields.</p>

**C7UPTMR signaling protocol Q764** (end)**Field descriptions for conditional datafill (Sheet 7 of 7)**

Field	Subfield or refinement	Entry	Explanation and action
	OPTION	MCD	<p><i>Option</i></p> <p>Enter MCD for Minimum Call Duration and datafill subfield MCD_TIMER.</p> <p>Enter \$ if no refinements have been defined.</p>
	MCD_TIMER	0 to 700	<p>Enter the time, in 10 ms units, between receiving an answer (ANS) message and sending a release message (REL).</p> <p>The MCD timer starts after an ANM message is received and stops after a REL message is sent.</p> <p>If a suspend (SUS) message is received while the MCD timer is active, a disconnect time is set and a REL message is sent when the timer expires.</p> <p>If a resume (RES) message is received before the MCD timer expires, the timer will be cleared and a REL message will not be sent.</p> <p>A value other than 0 must be entered in order to activate the timer.</p> <p>The default value is 0.</p>

**Datafill example**

The following example shows sample datafill for table C7UPTMR signaling protocol Q764.

**MAP display example for table C7UPTMR signaling protocol Q764**

```

TMRKEY   C7UPDIR  TMRS
OPTIONS

-----

2WANSITM 2W      Q764
13  2  25  6  60  10  180  20  200  13  60  2  32  3  600  (MCD 600)  $

```

## C7UPTMR signaling protocol Q767

---

### CCITT ISUP

Signaling protocol Q767 is used for CCITT ISUP.

*Note:* Although you can provision two-way (2W), incoming (IC), and outgoing (OG) trunks, only 2W trunks are supported—except for use with SSUTR2, also known as FTUP.

### Datafill

The following table lists the datafill for table C7UPTMR signaling protocol Q767.

#### Field descriptions

Field	Subfield or refinement	Entry	Explanation and action
PROT		see subfields	<i>Protocol</i>  If the entry in field C7UPDIR is 2W, this subfield consists of subfield BWPROT described in the following section “C7UPDIR = 2W”.  If the entry in field C7UPDIR is IC, this subfield consists of subfield ICPROT described in section “C7UPDIR = IC”.  If the entry in field C7UPDIR is OG, this subfield consists of subfield OGPROT described in section “C7UPDIR = OG”.

---

**C7UPTMR signaling protocol Q767** (continued)

---

**C7UPDIR = 2W**

If the entry subfield C7UPDIR is 2W, datafill subfield BWPROT and refinements as described below, then datafill field OPTIONS at the end of the following table..

**Field descriptions for conditional datafill (Sheet 1 of 12)**

Field	Subfield or refinement	Entry	Explanation and action
	BWPROT	Q767	<p><i>Two-way protocol</i></p> <p>Enter Q767 to indicate that the timers are CCITT7 ISUP timers</p>
	NQ764T1	1 to 60	<p><i>Release complete message timer</i></p> <p>Enter the time, in seconds, during which the release complete message (RCM) must be received after the release (RLS) message is sent.</p> <p>The timer starts when the RLS message is sent and stops when the RCM is received.</p> <p>When the timer expires, the RLS message is repeated and the timer is reinitialized.</p> <p>The default value is 15 (15 s).</p>
	NQ764T2	1 to 240	<p><i>User suspend message timer</i></p> <p>Enter the time, in seconds, that a call can be resumed after the user suspend message is sent.</p> <p>The timer starts when the controlling switch receives the suspend (user) message and stops on receipt of the resume (user) message at the controlling switch.</p> <p>When the timer expires, the call is released.</p> <p>The default value is 180 (180 s).</p>



## C7UPTMR signaling protocol Q767 (continued)

### Field descriptions for conditional datafill (Sheet 2 of 12)

Field	Subfield or refinement	Entry	Explanation and action
	NQ764T4	1 to 326	<p><i>Modification complete timer</i></p> <p>Enter the time allowed, in seconds, to modify the characteristics of a call if requested by the calling or called party to specialize in the transfer of speech or data.</p> <p>The timer starts when the local switch sends the call modification message and stops when the modification complete message is received.</p> <p>The default value is 326 (326 s).</p>
	NQ764T5	1 to 180	<p><i>Release complete message timer</i></p> <p>Enter the time, in seconds, between sending the RLS message and the receipt of the RCM message.</p> <p>When the timer expires, send a reset circuit (RSC) message, alert maintenance personnel, and remove the circuit from service.</p> <p>The timer starts when the initial RLS message is sent and stops when an RCM is received.</p> <p>The default value is 60 (60 s).</p>
	NQ764T6	1 to 240	<p><i>Call resume timer</i></p> <p>Enter the time, in seconds, in which a call can be resumed after a network suspend message is sent.</p> <p>The timer starts when the controlling switch receives a suspend (network) message and stops when a resume (network) message is received at the controlling switch.</p> <p>When the timer expires, the circuit is released.</p> <p>The default value is 90 (90 s).</p>

---

**C7UPTMR signaling protocol Q767** (continued)

---

**Field descriptions for conditional datafill (Sheet 3 of 12)**

Field	Subfield or refinement	Entry	Explanation and action
	NQ764T7	1 to 60	<p><i>Address complete message timer</i></p> <p>Enter the time, in seconds, between the sending of the address message and the receipt of an address complete message (ACM). This ensures the conditions for normal release of address and routing information are met.</p> <p>The timer starts when the latest address message is sent and stops when an ACM is received.</p> <p>When the timer expires, all equipment and connections are released.</p> <p>The default value is 20 (20 s).</p>
	NQ764T8	1 to 60	<p><i>Continuity message timer</i></p> <p>Enter the time, in seconds, between a transit or an international switch receiving an initial address message (IAM) and the receipt of a continuity (COT) message.</p> <p>The timer starts when a transit or incoming international switch receives an IAM and stops when a COT message is received.</p> <p>When the timer expires, all equipment and connections to the national network are released.</p> <p>The default value is 15 (15 s).</p>

## C7UPTMR signaling protocol Q767 (continued)

### Field descriptions for conditional datafill (Sheet 4 of 12)

Field	Subfield or refinement	Entry	Explanation and action
	NQ764T9	1 to 300	<p><i>Answer message timer</i></p> <p>Enter the time allowed, in seconds, to receive an answer (ANS) message after the controlling or outgoing international switch has received an ACM.</p> <p>The timer starts when either a controlling or outgoing international switch receives an ACM and stops on receipt of an ANS message.</p> <p>When the timer expires, all connections are released.</p> <p>The default value is 180 (180 s).</p>
	NQ764T10	1 to 30	<p><i>Interdigit timer</i></p> <p>Enter the time allowed, in seconds, between the last digit received and the receipt of additional information.</p> <p>The timer starts when the last digit is received in the interworking situation and stops when fresh information is received.</p> <p>When the timer expires, send an ACM.</p> <p>The default value is 5 (5 s).</p>
	NQ764T11	1 to 60	<p><i>Address complete message timer</i></p> <p>Enter the time allowed, in seconds, between the receipt of the latest address message in the interworking situation and the receipt of an ACM.</p> <p>The timer starts when the latest address message is received in an interworking situation and stops when an ACM is received.</p> <p>When the timer expires, send an ACM.</p> <p>The default value is 15 (15 s).</p>

## C7UPTMR signaling protocol Q767 (continued)

### Field descriptions for conditional datafill (Sheet 5 of 12)

Field	Subfield or refinement	Entry	Explanation and action
	NQ764T12	1 to 60	<p><i>Blocking acknowledgement message timer (first attempt)</i></p> <p>Enter the time allowed, in seconds, between the sending of the first blocking (BLO) message and the receipt of blocking acknowledgement (BLA) message.</p> <p>The timer starts when a BLO message is sent and stops on receipt of a BLA message.</p> <p>When the timer expires, the BLO message is repeated and the timer is reinitialized.</p> <p>The default value is 10 (10 s).</p>
	NQ764T13	1 to 180	<p><i>Blocking acknowledgement message timer (second attempt)</i></p> <p>Enter the time allowed, in seconds, between the second or repeated sending of a BLO message and the receipt of a BLA message.</p> <p>The timer starts when the initial BLO message is sent and stops when the BLA message is received.</p> <p>When the timer expires, alert maintenance personnel of the non-receipt of the BLA message and repeat the BLO message at 1-min intervals.</p> <p>The default value is 60 (60 s).</p>
	NQ764T14	1 to 60	<p><i>Unblocking acknowledgement message timer (first attempt)</i></p> <p>Enter the time allowed, in seconds, between the sending of the first unblocking (UBL) message and the receipt of the unblocking acknowledgement (UBA) message.</p> <p>The timer starts when the UBL message is sent and stops on receipt of the UBA message.</p> <p>When the timer expires, the UBL message is repeated and the timer is reinitialized.</p> <p>The default value is 10 (10 s).</p>

## C7UPTMR signaling protocol Q767 (continued)

### Field descriptions for conditional datafill (Sheet 6 of 12)

Field	Subfield or refinement	Entry	Explanation and action
	NQ764T15	1 to 180	<p><i>Unblocking acknowledgement message timer (second attempt)</i></p> <p>Enter the time allowed, in seconds, between the second or repeated sending of a UBL message and the receipt of a UBA message.</p> <p>The timer starts when the initial UBL message is sent and stops when the UBA message is received.</p> <p>When the timer expires, alert maintenance personnel of the non-receipt of the UBA message and repeat the UBL message at 1-min intervals.</p> <p>The default value is 60 (60 s).</p>
	NQ764T16	1 to 60	<p><i>Release complete message timer (first attempt)</i></p> <p>Enter the time allowed, in seconds, between the sending of an RSC message and the receipt of an RCM.</p> <p>The timer starts when RSC is sent and stops when an RCM is received.</p> <p>When the timer expires, repeat the RSC message.</p> <p>The default value is 10 (10 s).</p>
	NQ764T17	1 to 180	<p><i>Release complete message timer (second attempt)</i></p> <p>Enter the time allowed, in seconds, between the second or repeated sending of an RSC message and the receipt of an RCM.</p> <p>The timer starts when the initial RSC message is sent and stops when the RCM is received.</p> <p>When the timer expires, alert maintenance personnel of the non-receipt of the RCM and repeat the RSC message at 1-min intervals.</p> <p>The default value is 60 (60 s).</p>

---

**C7UPTMR signaling protocol Q767** (continued)

---

**Field descriptions for conditional datafill (Sheet 7 of 12)**

Field	Subfield or refinement	Entry	Explanation and action
	NQ764T18	1 to 60	<p><i>Group blocking acknowledgement message timer (first attempt)</i></p> <p>Enter the time allowed, in seconds, between the sending of the first group BLO message and the receipt of the group BLA message.</p> <p>The timer starts when a group BLO message is sent and stops when a group BLA message is received.</p> <p>When the timer expires, the group BLO message is repeated and the timer is reinitialized.</p> <p>The default value is 10 (10 s).</p>
	NQ764T19	1 to 180	<p><i>Group blocking acknowledgement message timer (second attempt)</i></p> <p>Enter the time allowed, in seconds, between the second or repeated sending of a group BLO message and the receipt of a group BLA message.</p> <p>The timer starts when the initial group BLO message is sent and stops when the group BLA message is received.</p> <p>When the timer expires, alert maintenance personnel of the non-receipt of group BLA and repeat the group BLO message at 1-min intervals.</p> <p>The default value is 60 (60 s).</p>

## C7UPTMR signaling protocol Q767 (continued)

### Field descriptions for conditional datafill (Sheet 8 of 12)

Field	Subfield or refinement	Entry	Explanation and action
	NQ764T20	1 to 60	<p><i>Group unblocking acknowledge message timer (first attempt)</i></p> <p>Enter the time allowed, in seconds, between the sending of the first group UBL message and the receipt of a group UBA message.</p> <p>The timer starts when a group UBL message is sent and stops when a group UBA message is received.</p> <p>When the timer expires, the group UBL message is repeated and timer is reinitialized.</p> <p>The default value is 10 (10 s).</p>
	NQ764T21	1 to 180	<p><i>Group unblocking acknowledgement message timer (first attempt)</i></p> <p>Enter the time allowed, in seconds, between the second or repeated sending of a group UBL message and the receipt of a group UBA message.</p> <p>The timer starts when the initial group UBL message is sent and stops when the group UBA acknowledgement message is received.</p> <p>When the timer expires, alert maintenance personnel of the non-receipt of a group UBA message and repeat the group UBL message at 1-min intervals.</p> <p>The default value is 60 (60 s).</p>
	NQ764T22	1 to 60	<p><i>Group release complete message timer (first attempt)</i></p> <p>Enter the time allowed, in seconds, between the sending of a group RSC message and the receipt of a group RCM.</p> <p>The timer starts when an RSC message is sent and stops when the RCM is received.</p> <p>When the timer expires, repeat the group RSC message.</p> <p>The default value is 10 (10 s).</p>

---

**C7UPTMR signaling protocol Q767** (continued)

---

**Field descriptions for conditional datafill (Sheet 9 of 12)**

Field	Subfield or refinement	Entry	Explanation and action
	NQ764T23	1 to 180	<p><i>Group release complete message timer (second attempt)</i></p> <p>Enter the time allowed, in seconds, between the second or repeated sending of a group RSC message and the receipt of a group RSC message.</p> <p>The timer starts when the initial group RSC message is sent and stops when the group RSC message is received.</p> <p>When the timer expires, alert maintenance personnel of the non-receipt of the group RSC message and repeat the group RSC message at 1-min intervals.</p> <p>The default value is 60 (60 s).</p>
	NQ764T24	100 to 2000	<p><i>Backward check tone timer</i></p> <p>Enter the time allowed, in milliseconds, to receive the backward check tone after the check tone is sent.</p> <p>The timer starts when the check tone is sent and stops when the backward check tone is received.</p> <p>When the timer expires, report the failure.</p> <p>The default value is 1000 (1 s).</p>
	NQ764T25	1 to 30	<p><i>Continuity check request message timer</i></p> <p>Enter the time allowed, in seconds, after a continuity check failure is detected and the continuity check request message is sent.</p> <p>The timer starts when a continuity check failure is detected and stops when information is not given.</p> <p>When the timer expires, the continuity check request message is sent.</p> <p>The default value is 10 (10 s).</p>



## C7UPTMR signaling protocol Q767 (continued)

### Field descriptions for conditional datafill (Sheet 10 of 12)

Field	Subfield or refinement	Entry	Explanation and action
	NQ764T26	1 to 240	<p><i>Second continuity check request message timer</i></p> <p>Enter the time allowed, in seconds, after the second continuity check failure is detected and the continuity check request message is sent.</p> <p>The timer starts when the second continuity check failure is detected and stops when information is not given.</p> <p>When the timer expires, a continuity check request message is sent.</p> <p>The default value is 120 (120 s).</p>
	NQ764T27	1 to 300	<p><i>Continuity check request message timer</i></p> <p>Enter the time allowed, in seconds, to receive a continuity check request message after a continuity recheck is requested.</p> <p>The timer starts when continuity recheck is requested and stops when a continuity check request message is received.</p> <p>When the timer expires, return the circuit to idle.</p> <p>The default value is 240 (240 s).</p>
	NQ764T28	1 to 30	<p><i>Circuit group query reception message timer</i></p> <p>Enter the time allowed, in seconds, to receive a circuit group query reception message after sending a circuit group query message.</p> <p>The timer starts when the circuit group query message is sent and stops when a circuit group query reception message is received.</p> <p>When the timer expires, alert maintenance personnel.</p> <p>The default value is 10 (10 s).</p>

---

**C7UPTMR signaling protocol Q767** (continued)

---

**Field descriptions for conditional datafill (Sheet 11 of 12)**

Field	Subfield or refinement	Entry	Explanation and action
	NQ764T35 (-BCS35)	1 to 60	<p><i>Minimum number of digits to commence overlap outpulsing timer</i></p> <p>Enter the time allowed, in seconds, to receive the minimum number of address digits required to commence overlap outpulsing.</p> <p>The timer starts on receipt of an IAM containing less than the minimum number of digits required to commence outpulsing.</p> <p>The timer does not start if the IAM contains an ST signal.</p> <p>The timer is reset each a subsequent address message (SAM) that fails to increment the total number of digits to equal or exceed the minimum required is received.</p> <p>The timer is terminated if an outgoing trunk is seized.</p> <p>When the timer expires, the call is taken down. The treatment of the incoming trunk depends on the datafill in table TMTMAP.</p> <p>The default value is 20 (20 s).</p>

## C7UPTMR signaling protocol Q767 (continued)

### Field descriptions for conditional datafill (Sheet 12 of 12)

Field	Subfield or refinement	Entry	Explanation and action
	NQ764T37 (-BCS35)	1 to 30	<p><i>Completion of address digit collection timer</i></p> <p>Enter the time allowed, in seconds, to receive the remaining address digits.</p> <p>The timer starts on seizure of an outgoing trunk if there is no indication that all digits are received (ST digit or 18 digits).</p> <p>The timer is reset each time a SAM that does not contain an ST digit is received.</p> <p>The timer is terminated on receipt of an ST signal, or on the receipt of an ACM or CON message that indicates the completion of overlap outpulsing.</p> <p>The expiry of this timer indicates that all address digit related to this call are were received and call processing can proceed.</p> <p>The default value is 4 (4 s).</p> <p><b>Note:</b> Outpulsing enbloc cannot commence until after this timer expires.</p>
OPTIONS (BCS36-)		Q33 or \$	<p><i>Timer options list</i></p> <p>Enter Q33 for the Q33 option and datafill refinement Q33_TIMER. Otherwise, enter \$.</p>
	Q33_TIMER	10 to 30	<p><i>Q33 timer</i></p> <p>Enter the time, in seconds, for the Q33 timer.</p>

---

**C7UPTMR signaling protocol Q767** (continued)

---

**C7UPDIR = IC**

If the entry in subfield C7UPDIR is IC, datafill subfield ICPROT and refinements as described below, then datafill field OPTIONS as described at the end of the following table..

**Field descriptions for conditional datafill (Sheet 1 of 11)**

Field	Subfield or refinement	Entry	Explanation and action
	ICPROT	Q767	<i>Incoming protocol</i>  Enter Q767 to indicate that the timers are CCITT7 ISUP timers.
	NQ764T1	1 to 60	<i>Release complete message timer</i>  Enter the time, in seconds, to wait for a release complete message (RCM) after the release (RLS) message is sent.  The timer starts when the RLS message is sent and stops when the RCM is received.  When the timer expires, the RLS message is sent and the timer is reinitialized.  The default value is 15 (15 s).
	NQ764T2	1 to 240	<i>User suspend message timer</i>  Enter the time, in seconds, to wait for a call to be resumed after the user suspend (SUS) message is sent.  The timer starts when the controlling switch receives the SUS message and stops when the resume (RES) (user) message is received at the controlling switch.  When the timer expires, the call is released.  The default value is 180 (180 s).

## C7UPTMR signaling protocol Q767 (continued)

### Field descriptions for conditional datafill (Sheet 2 of 11)

Field	Subfield or refinement	Entry	Explanation and action
	NQ764T4	1 to 326	<p><i>Modification complete timer</i></p> <p>Enter the time allowed, in seconds, to modify the characteristics of a call, if requested by the calling or called party, to specialize in the transfer of speech or data.</p> <p>The timer starts when the local switch sends the call modification message and stops when the modification complete message is received.</p> <p>The default value is 326 (326 s).</p>
	NQ764T5	1 to 180	<p><i>Release complete message timer</i></p> <p>Enter the time, in seconds, between sending the RLS message and receiving the RCM.</p> <p>When the timer expires, send a reset circuit (RSC) signal, alert maintenance personnel, and remove the circuit from service.</p> <p>The timer starts when the initial RLS message is sent and stops when an RCM is received.</p> <p>The default value is 60 (60 s).</p>
	NQ764T6	1 to 240	<p><i>Call resume timer</i></p> <p>Enter the time, in seconds, to wait for a call to be resumed after a network suspend message is sent.</p> <p>The timer starts when the controlling switch receives an SUS (network) message and stops when an RES (network) message is received at the controlling switch.</p> <p>When the timer expires, the circuit is released.</p> <p>The default value is 90 (90 s).</p>

---

**C7UPTMR signaling protocol Q767** (continued)

---

**Field descriptions for conditional datafill (Sheet 3 of 11)**

Field	Subfield or refinement	Entry	Explanation and action
	NQ764T8	1 to 60	<p><i>Continuity message timer</i></p> <p>Enter the time, in seconds, between a transit switch or an international switch receiving an initial address message (IAM) and receiving a continuity (COT) message.</p> <p>The timer starts when a transit or incoming international switch receives an IAM and stops when a COT message is received.</p> <p>When the timer expires, all equipment and connections to the national network are released.</p> <p>The default value is 15 (15 s).</p>
	NQ764T10	1 to 30	<p><i>Interdigit timer</i></p> <p>Enter the time allowed, in seconds, between the last digit and receiving additional information.</p> <p>The timer starts when the last digit is received in the interworking situation and stops when additional information is received.</p> <p>When the timer expires, send an address complete message (ACM).</p> <p>The default value is 5 (5 s).</p>
	NQ764T11	1 to 60	<p><i>Address complete message timer</i></p> <p>Enter the time allowed, in seconds, between receiving the latest address message in the interworking situation and receiving an ACM.</p> <p>The timer starts when the latest address message is received in an interworking situation and stops when an ACM is received.</p> <p>When the timer expires, send an ACM.</p> <p>The default value is 15 (15 s).</p>

## C7UPTMR signaling protocol Q767 (continued)

### Field descriptions for conditional datafill (Sheet 4 of 11)

Field	Subfield or refinement	Entry	Explanation and action
	NQ764T12	1 to 60	<p><i>Blocking acknowledgement message timer (first attempt)</i></p> <p>Enter the time allowed, in seconds, between sending the first blocking (BLO) message and receiving the blocking acknowledgement (BLA) message.</p> <p>The timer starts when BLO message is sent and stops when a BLA message is received.</p> <p>When the timer expires, a BLO message is sent and the timer is reinitialized.</p> <p>The default value is 10 (10 s).</p>
	NQ764T13	1 to 180	<p><i>Blocking acknowledgement message timer (second attempt)</i></p> <p>Enter the time allowed, in seconds, between sending a second or repeated BLO message and receiving a BLA message.</p> <p>The timer starts when the initial BLO message is sent and stops when the BLA message is received.</p> <p>When the timer expires, alert maintenance personnel that a BLA message was not received and send a BLO message at 1-min intervals.</p> <p>The default value is 60 (60 s).</p>
	NQ764T14	1 to 60	<p><i>Unblocking acknowledgement message timer (first attempt)</i></p> <p>Enter the time allowed, in seconds, between sending the first unblocking (UBL) message and receiving the unblocking acknowledgement (UBA) message.</p> <p>The timer starts when a UBL message is sent and stops when a UBA message is received.</p> <p>When the timer expires, a UBL message is sent and the timer is reinitialized.</p> <p>The default value is 10 (10 s).</p>

## C7UPTMR signaling protocol Q767 (continued)

### Field descriptions for conditional datafill (Sheet 5 of 11)

Field	Subfield or refinement	Entry	Explanation and action
	NQ764T15	1 to 180	<p><i>Unblocking acknowledgement message timer (second attempt)</i></p> <p>Enter the time allowed, in seconds, between the second or repeated UBL message and receiving a UBA message.</p> <p>The timer starts when the initial UBL message is sent and stops when the UBA message is received.</p> <p>When the timer expires, alert maintenance personnel that a UBA message was not received and send a UBL message at 1-min intervals.</p> <p>The default value is 60 (60 s).</p>
	NQ764T16	1 to 60	<p><i>Release complete message timer (first attempt)</i></p> <p>Enter the time allowed, in seconds, between sending an RSC message and receiving an RCM.</p> <p>The timer starts when an RSC message is sent and stops when an RCM is received.</p> <p>When the timer expires, send the RSC message again.</p> <p>The default value is 10 (10 s).</p>
	NQ764T17	1 to 180	<p><i>Release complete message timer (second attempt)</i></p> <p>Enter the time allowed, in seconds, between the second or repeated RSC message and receiving an RCM.</p> <p>The timer starts when the initial RSC message is sent and stops when the RCM is received.</p> <p>When the timer expires, alert maintenance personnel that an RCM was not received and send RSC messages at 1-min intervals.</p> <p>The default value is 60 (60 s).</p>



## C7UPTMR signaling protocol Q767 (continued)

### Field descriptions for conditional datafill (Sheet 6 of 11)

Field	Subfield or refinement	Entry	Explanation and action
	NQ764T18	1 to 60	<p><i>Group blocking acknowledgement message timer (first attempt)</i></p> <p>Enter the time allowed, in seconds, between sending the first group BLO message and receiving the group BLA message.</p> <p>The timer starts when a group BLO message is sent and stops when a group BLA message is received.</p> <p>When the timer expires, the group BLO message is sent and the timer is reinitialized.</p> <p>The default value is 10 (10 s).</p>
	NQ764T19	1 to 180	<p><i>Group blocking acknowledgement message timer (second attempt)</i></p> <p>Enter the time allowed, in seconds, between the second or repeated group BLO message and receiving a group BLA message.</p> <p>The timer starts when the initial group BLO message is sent and stops when the group BLA message is received.</p> <p>When the timer expires, alert maintenance personnel that a group BLA was not received and send the group BLO message at 1-min intervals.</p> <p>The default value is 60 (60 s).</p>
	NQ764T20	1 to 60	<p><i>Group unblocking acknowledge message timer (first attempt)</i></p> <p>Enter the time allowed, in seconds, between sending the first group UBL message and receiving a group UBA message.</p> <p>The timer starts when a group UBL message is sent and stops when a group UBA message is received.</p> <p>When the timer expires, the group UBL message is repeated and timer is reinitialized.</p> <p>The default value is 10 (10 s).</p>

---

**C7UPTMR signaling protocol Q767** (continued)
 

---

**Field descriptions for conditional datafill (Sheet 7 of 11)**

Field	Subfield or refinement	Entry	Explanation and action
	NQ764T21	1 to 180	<p><i>Group unblocking acknowledgement message timer (second attempt)</i></p> <p>Enter the time allowed, in seconds, between sending the second or repeated group UBL message and receiving of a group UBA message.</p> <p>The timer starts when the initial group UBL message is sent and stops when the group UBA message is received.</p> <p>When the timer expires, alert maintenance personnel that a group UBA message was not received and send the group UBL message at 1-min intervals.</p> <p>The default value is 60 (60 s).</p>
	NQ764T22	1 to 60	<p><i>Group release complete message timer (first attempt)</i></p> <p>Enter the time allowed, in seconds, between sending a group RES message and receiving a group RLC message.</p> <p>The timer starts when an RSC message is sent and stops when an RCM is received.</p> <p>When the timer expires, send the group RSC message again.</p> <p>The default value is 10 (10 s).</p>

**C7UPTMR signaling protocol Q767** (continued)

## Field descriptions for conditional datafill (Sheet 8 of 11)

Field	Subfield or refinement	Entry	Explanation and action
	NQ764T23	1 to 180	<p><i>Group release complete message timer (second attempt)</i></p> <p>Enter the time allowed, in seconds, between sending the second or repeated group RSC message and receiving a group RCM.</p> <p>The timer starts when the initial group RSC message is sent and stops when the group RCM is received.</p> <p>When the timer expires, alert maintenance personnel that the group RCM was not received and repeat the group RSC message at 1-min intervals.</p> <p>The default value is 60 (60 s).</p>
	NQ764T25	1 to 30	<p><i>Continuity check request message timer</i></p> <p>Enter the time allowed, in seconds, between detecting a continuity check failure and sending a continuity check request (CCR) message.</p> <p>The timer starts when continuity check failure is detected and stops when information is not given.</p> <p>When the timer expires, the CCR message is sent.</p> <p>The default value is 10 (10 s).</p>
	NQ764T26	1 to 240	<p><i>Second continuity check request message timer</i></p> <p>Enter the time allowed, in seconds, between detecting a second continuity check failure and sending a CCR message.</p> <p>The timer starts when the second continuity check failure is detected and stops when information is not given.</p> <p>When the timer expires, a CCR message is sent.</p> <p>The default value is 120 (120 s).</p>

---

**C7UPTMR signaling protocol Q767** (continued)

---

**Field descriptions for conditional datafill (Sheet 9 of 11)**

<b>Field</b>	<b>Subfield or refinement</b>	<b>Entry</b>	<b>Explanation and action</b>
	NQ764T27	1 to 300	<p><i>Continuity check request message timer</i></p> <p>Enter the time allowed, in seconds, to receive a CCR message after a continuity recheck is requested.</p> <p>The timer starts when continuity recheck is requested and stops when a CCR message is received.</p> <p>When the timer expires, return the circuit to idle.</p> <p>The default value is 240 (240 s).</p>
	NQ764T28	1 to 30	<p><i>Circuit group query reception message timer</i></p> <p>Enter the time allowed, in seconds, to receive a circuit group query reception message after sending a circuit group query message.</p> <p>The timer starts when the circuit group query message is sent and stops when a circuit group query reception message is received.</p> <p>When the timer expires, alert maintenance personnel.</p> <p>The default value is 10 (10 s).</p>

## C7UPTMR signaling protocol Q767 (continued)

### Field descriptions for conditional datafill (Sheet 10 of 11)

Field	Subfield or refinement	Entry	Explanation and action
	NQ764T35 (-BCS35)	1 to 60	<p><i>Minimum number of digits to commence overlap outpulsing timer</i></p> <p>Enter the time allowed, in seconds, to receive the minimum number of address digits required to commence overlap outpulsing.</p> <p>The timer starts on receipt of an IAM containing less than the minimum number of digits required to commence outpulsing.</p> <p>The timer does not start if the IAM contains an ST signal.</p> <p>The timer is reset each a subsequent address message (SAM) that fails to increment the total number of digits to equal or exceed the minimum required is received.</p> <p>The timer is terminated if an outgoing trunk is seized.</p> <p>When the timer expires, the call is taken down. The treatment of the incoming trunk depends on the datafill in table TMTMAP.</p> <p>The default value is 20 (20 s).</p>

---

**C7UPTMR signaling protocol Q767** (continued)

---

**Field descriptions for conditional datafill (Sheet 11 of 11)**

Field	Subfield or refinement	Entry	Explanation and action
	NQ764T37 (-BCS35)	1 to 30	<p><i>Completion of address digit collection timer</i></p> <p>Enter the time allowed, in seconds, to receive the remaining address digits.</p> <p>The timer starts on seizure of an outgoing trunk if there is no indication that all digits are received (ST digit or 18 digits).</p> <p>The timer is reset each time a SAM that does not contain an ST digit is received.</p> <p>The timer is terminated on receipt of an ST signal, or on the receipt of an ACM or CON message that indicates the completion of overlap outpulsing.</p> <p>The expiry of this timer indicates that all address digit related to this call are were received and call processing can proceed.</p> <p>The default value is 4 (4 s).</p> <p><b>Note:</b> Outpulsing enbloc cannot commence until after this timer expires.</p>
OPTIONS (BCS36-)		Q33 or \$	<p><i>Timer options list</i></p> <p>Enter Q33 for the Q33 option and datafill refinement Q33_TIMER. Otherwise, enter \$.</p>
	Q33_TIMER	10 to 30	<p><i>Q33 timer</i></p> <p>Enter the time, in seconds, for the Q33 timer.</p>

**C7UPTMR signaling protocol Q767** (continued)**C7UPDIR = OG**

If the entry subfield C7UPDIR is OG, datafill subfield OGPROT and refinements as described below, then datafill field OPTIONS as described at the end of the following table..

**Field descriptions for conditional datafill (Sheet 1 of 6)**

Field	Subfield or refinement	Entry	Explanation and action
	OGPROT	Q767	<i>Outgoing protocol</i> Enter Q767 to indicate that the timers are CCITT7 ISUP timers
	NQ764T1	1 to 60	<i>Release complete message timer</i> Enter the time, in seconds, during which the release complete message (RCM) must be received after the release (RLS) message is sent.  The timer starts when the RLS message is sent and stops when the RCM is received.  When the timer expires, the RLS message is repeated and the timer is reinitialized.  The default value is 15 (15 s).
	NQ764T2	1 to 240	<i>User suspend message timer</i> Enter the time, in seconds, during which a call can be resumed after the user suspend message is sent.  The timer starts when the controlling switch receives the suspend (user) message and stops when the resume (user) message is received at the controlling switch.  When the timer expires, the call is released.  The default value is 180 (180 s).

---

**C7UPTMR signaling protocol Q767** (continued)

---

**Field descriptions for conditional datafill (Sheet 2 of 6)**

Field	Subfield or refinement	Entry	Explanation and action
	NQ764T4	1 to 326	<p><i>Modification complete timer</i></p> <p>Enter the time allowed, in seconds, to modify the characteristics of a call if requested by the calling or called party to specialize in the transfer of speech or data.</p> <p>The timer starts when the local switch sends the call modification message and stops when the modification complete message is received.</p> <p>The default value is 326 (326 s).</p>
	NQ764T5	1 to 180	<p><i>Release complete message timer</i></p> <p>Enter the time allowed, in seconds, between sending of the RLS message and the receipt of the RCM.</p> <p>When the timer expires, send a reset circuit (RSC) message, alert maintenance personnel, and remove the circuit from service.</p> <p>The timer starts when the initial RLS message is sent and stops when an RCM is received.</p> <p>The default value is 60 (60 s).</p>
	NQ764T6	1 to 240	<p><i>Call resume timer</i></p> <p>Enter the time, in seconds, in which a call can be resumed after a network suspend message is sent.</p> <p>The timer starts when the controlling switch receives suspend (network) message and stops when a resume (network) message is received at the controlling switch.</p> <p>When the timer expires, the circuit is released.</p> <p>The default value is 90 (90 s).</p>



**C7UPTMR signaling protocol Q767** (continued)

## Field descriptions for conditional datafill (Sheet 3 of 6)

Field	Subfield or refinement	Entry	Explanation and action
	NQ764T7	1 to 60	<p><i>Address complete message timer</i></p> <p>Enter the time allowed, in seconds, between the sending of the address message and the receipt of an address complete message (ACM). This ensures that the conditions for normal release of address and routing information are met.</p> <p>The timer starts when the latest address message is sent and stops when an ACM is received.</p> <p>When the timer expires, all equipment and connections are released.</p> <p>The default value is 20 (20 s).</p>
	NQ764T9	1 to 300	<p><i>Answer message timer</i></p> <p>Enter the time allowed, in seconds, to receive an answer message after the controlling or outgoing international switch received an ACM.</p> <p>The timer starts when either a controlling or outgoing international switch receives an ACM and stops on receipt of an answer message.</p> <p>When the timer expires, all connections are released.</p> <p>The default value is 180 (180 s).</p>
	NQ764T16	1 to 60	<p><i>Release complete message timer (first attempt)</i></p> <p>Enter the time allowed, in seconds, between the sending of a RSC message and the receipt of an RCM.</p> <p>The timer starts when an RSC message is sent and stops when an RCM is received.</p> <p>When the timer expires, repeat the RSC message.</p> <p>The default value is 10 (10 s).</p>

---

**C7UPTMR signaling protocol Q767** (continued)
 

---

**Field descriptions for conditional datafill (Sheet 4 of 6)**

Field	Subfield or refinement	Entry	Explanation and action
	NQ764T17	1 to 180	<p><i>Release complete message timer (second attempt)</i></p> <p>Enter the time allowed, in seconds, between the second or repeated sending of an RSC message and the receipt of a RCM.</p> <p>The timer starts when the initial RSC message is sent and stops when the RCM is received.</p> <p>When the timer expires, alert maintenance personnel of the non-receipt of the RCM and repeat the RSC message at 1-min intervals.</p> <p>The default value is 60 (60 s).</p>
	NQ764T22	1 to 60	<p><i>Group release complete message timer (first attempt)</i></p> <p>Enter the time allowed, in seconds, between the sending of a group reset circuit message and the receipt of a group release complete message.</p> <p>The timer starts when an RSC message is sent and stops when RCM is received.</p> <p>When the timer expires, repeat the group reset circuit message.</p> <p>The default value is 10 (10 s).</p>

**C7UPTMR signaling protocol Q767** (continued)

## Field descriptions for conditional datafill (Sheet 5 of 6)

Field	Subfield or refinement	Entry	Explanation and action
	NQ764T23	1 to 180	<p><i>Group release complete message timer (second attempt)</i></p> <p>Enter the time allowed, in seconds, between the second or repeated sending of a group reset circuit message and the receipt of a group release circuit message.</p> <p>The timer starts when the initial group reset circuit message is sent and stops when the group release circuit message is received.</p> <p>When the timer expires, alert maintenance personnel of the non-receipt of the group release circuit message and repeat the group reset circuit at 1-min intervals.</p> <p>The default value is 60 (60 s).</p>
	NQ764T24	100 to 2000	<p><i>Backward check tone timer</i></p> <p>Enter the time allowed, in milliseconds, to receive the backward check tone after the check tone is sent.</p> <p>The timer starts when the check tone is sent and stops when the backward check tone is received.</p> <p>When the timer expires, report the failure.</p> <p>The default value is 1000 (1 s).</p>
	NQ764T25	1 to 30	<p><i>Continuity check request message timer</i></p> <p>Enter the time allowed, in seconds, after continuity check failure is detected and the continuity check request (CCR) message is sent.</p> <p>The timer starts when continuity check failure is detected and stops when information is not given.</p> <p>When the timer expires, the CCR message is sent.</p> <p>The default value is 10 (10 s).</p>

**C7UPTMR signaling protocol Q767** (continued)

## Field descriptions for conditional datafill (Sheet 6 of 6)

Field	Subfield or refinement	Entry	Explanation and action
	NQ764T26	1 to 240	<p><i>Second continuity check request message timer</i></p> <p>Enter the time allowed, in seconds, after the second continuity check failure is detected and the CCR message is sent.</p> <p>The timer starts when the second continuity check failure is detected and stops when information is not given.</p> <p>When the timer expires, a CCR message is sent.</p> <p>The default value is 120 (120 s).</p>
	NQ764T27	1 to 300	<p><i>Continuity check request message timer</i></p> <p>Enter the time allowed, in seconds, to receive a CCR message after a continuity recheck is requested.</p> <p>The timer starts when continuity recheck is requested and stops when a CCR message is received.</p> <p>When the timer expires, return the circuit to idle.</p> <p>The default value is 240 (240 s).</p>
	NQ764T28	1 to 30	<p><i>Circuit group query reception message timer</i></p> <p>Enter the time allowed, in seconds, to receive a circuit group query reception message after sending a circuit group query message.</p> <p>The timer starts when the circuit group query message is sent and stops when a circuit group query reception message is received.</p> <p>When the timer expires, alert maintenance personnel.</p> <p>The default value is 10 (10 s).</p>
OPTIONS (BCS36-)		\$	<p><i>Timer options list</i></p> <p>No refinements defined. Enter \$.</p>

---

## C7UPTMR signaling protocol Q767 (end)

---

### Datafill example

The following example shows sample datafill for table C7UPTMR signaling protocol Q767.

### MAP display example for table C7UPTMR signaling protocol Q767

TMRKEY C7UPDIR		TMRS												
OPTIONS														
<hr/>														
OGQ767		OG	Q767	15	10	90	10	90	60	90	60	60	60	60
100	30	200	100	30	\$									

---

## C7UPTMR signaling protocol TUP\_BLUE

---

### Signaling 7 protocols BTUP & TUPPLUS DMS-300 internetworking

Signaling protocol TUP\_BLUE is used by the DMS-300 switch for interworking with signaling 7 protocols BTUP and TUPPLUS (TUP+).

#### Datafill

The following table lists the datafill for table C7UPTMR signaling protocol TUP\_BLUE.

#### Field descriptions

Field	Subfield or refinement	Entry	Explanation and action
	PROT	see subfields	<p><i>Protocol</i></p> <p>If the entry in field C7UPDIR is 2W, this subfield consists of subfield BWPROT described in Section "C7UPDIR = 2W".</p> <p>If the entry in field C7UPDIR is IC, this subfield consists of subfield ICPROT described in Section "C7UPDIR = IC".</p> <p>If the entry in field C7UPDIR is OG, this subfield consists of subfield OGPROT described in Section "C7UPDIR = OG".</p>

---

**C7UPTMR signaling protocol TUP\_BLUE** (continued)
 

---

**C7UPDIR = 2W**

If the entry subfield C7UPDIR is 2W, datafill subfield BWPROT and refinements as described below.

**Field descriptions for conditional datafill (Sheet 1 of 9)**

Field	Subfield or refinement	Entry	Explanation and action
	BWPROT	TUP_BLUE	<p><i>Two-way protocol</i> Enter TUP_BLUE to indicate that the timers are used for signaling between the DMS-300 and a United Kingdom digital international switching center.</p>
	TUPT01	10 to 15	<p><i>Continuity or continuity failure signal timer</i> Enter the time, in seconds, to wait for a continuity or continuity-failure signal after receiving an initial address message (IAM).  The timer starts when the IAM is received and stops when a continuity or continuity-failure signal is received.  When the timer expires, all equipment is released, a clear-forward and a call-failure signal are sent.  The default value is 13 (13 s).</p>
	TUPT02	20 to 30	<p><i>Address complete signal timer</i> Enter the time, in seconds, to wait for an address complete signal after sending the latest address message.  This timer starts when an address message is sent and stops when an address complete signal is received.  When the timer expires, all equipment is released and the connection is cleared forward.  The default value is 25 (25 s).</p>

---

**C7UPTMR signaling protocol TUP\_BLUE** (continued)
 

---

**Field descriptions for conditional datafill (Sheet 2 of 9)**

Field	Subfield or refinement	Entry	Explanation and action
	TUPT03	4 to 15	<p><i>Clear-forward signal timer</i> Enter the time, in seconds, to wait for a clear-forward signal after sending an unsuccessful backward setup information message.</p> <p>This timer starts when an unsuccessful backward setup information message is sent and stops when a clear-forward signal is received.</p> <p>When the timer expires, a call-failure signal is sent.</p> <p>The default value is 10 (10 s).</p>
	TUPT04	4 to 15	<p><i>Clear-forward signal timer</i> Enter the time, in seconds, to wait for a clear-forward signal after sending a call-failure signal.</p> <p>This timer starts when a call-failure signal is sent and stops when a clear-forward signal is received.</p> <p>When the timer expires, a call-failure signal is sent.</p> <p>The default value is 10 (10 s).</p>
	TUPT06	4 to 15	<p><i>Release guard signal timer</i> Enter the time, in seconds, to wait for a release guard signal after sending a clear forward signal.</p> <p>This timer starts when a clear forward signal is sent and stops when a release guard signal is received.</p> <p>When the timer expires, a clear forward signal is sent.</p> <p>The default value is 10 (10 s).</p>



## C7UPTMR signaling protocol TUP\_BLUE (continued)

### Field descriptions for conditional datafill (Sheet 3 of 9)

Field	Subfield or refinement	Entry	Explanation and action
	TUPT08	1 to 2	<p><i>Backward check tone timer</i> Enter the time, in seconds, to wait for a backward check tone after sending a forward check tone.</p> <p>This timer starts when a forward check tone is sent and stops when a backward check tone is received.</p> <p>When the timer expires, a forward check tone is sent.</p> <p>The default value is 2 (2 s).</p>
	TUPT09	1 to 10	<p><i>First time continuity recheck timer</i> Enter the time, in seconds, to wait before the first repeat attempt of the continuity check after detecting the initial continuity check failure.</p> <p>This timer starts when a continuity check failure is detected and stops when the first repeat continuity check is made.</p> <p>When the timer expires, a repeat continuity check is sent.</p> <p>The default value is 5 (5 s).</p>
	TUPT10	60 to 180	<p><i>Multiple continuity recheck timer</i> Enter the time, in seconds, to wait before making a second (or greater) attempt of the continuity check after detecting a continuity check failure on the first (or subsequent) repeat continuity check.</p> <p>This timer starts when the first (or greater) repeat continuity check failure is detected and stops when continuity is detected.</p> <p>When the timer expires, another repeat continuity check is sent.</p> <p>The default value is 870 (870 s).</p>

---

**C7UPTMR signaling protocol TUP\_BLUE** (continued)
 

---

**Field descriptions for conditional datafill (Sheet 4 of 9)**

Field	Subfield or refinement	Entry	Explanation and action
	TUPT12	4 to 15	<p><i>Blocking acknowledgement signal timer</i> Enter the time, in seconds, to wait for a blocking acknowledgement (BLA) signal after sending a blocking (BLO) signal.</p> <p>This timer starts when a BLO signal is sent and stops when a BLA signal is received.</p> <p>When the timer expires, a BLO signal is sent.</p> <p>The default value is 10 (10 s).</p>
	TUPT15	4 to 15	<p><i>Unblocking acknowledgement signal timer</i> Enter the time, in seconds, to wait for an unblocking acknowledgement (UBA) signal after sending an unblocking (UBL) signal.</p> <p>This timer starts when a UBL signal is sent and stops when a UBA signal is received.</p> <p>When the timer expires, a UBL signal is sent.</p> <p>The default value is 10 (10 s).</p>
	TUPT18	4 to 15	<p><i>Unblocking acknowledgement signal timer</i> Enter the time, in seconds, to wait for a release complete (RLC) signal after sending a reset circuit (RSC) signal.</p> <p>This timer starts when an RSC signal is sent and stops when a release complete signal is received.</p> <p>When the timer expires, an RSC signal is sent.</p> <p>The default value is 10 (10 s).</p>

---

**C7UPTMR signaling protocol TUP\_BLUE** (continued)
 

---

**Field descriptions for conditional datafill (Sheet 5 of 9)**

Field	Subfield or refinement	Entry	Explanation and action
	TUPT21	4 to 15	<p><i>Circuit group reset acknowledgement message timer</i>            Enter the time, in seconds, to wait for a circuit group reset acknowledgement message after sending a circuit group reset message.</p> <p>This timer starts when a circuit group reset message is sent and stops when a circuit group reset acknowledgement message is received.</p> <p>When the timer expires, a circuit group reset message is sent.</p> <p>The default value is 10 (10 s).</p>
	TUPT26	4 to 15	<p><i>Maintenance-oriented group blocking acknowledgement message timer</i>            Enter the time, in seconds, to wait for a maintenance-oriented group BLA message after sending a maintenance-oriented group BLO message.</p> <p>This timer starts when a maintenance-oriented group BLO message is sent and stops when a maintenance-oriented group BLA message is received.</p> <p>When the timer expires, a maintenance-oriented group BLO message is sent.</p> <p>The default value is 10 (10 s).</p>

---

**C7UPTMR signaling protocol TUP\_BLUE** (continued)
 

---

**Field descriptions for conditional datafill (Sheet 6 of 9)**

Field	Subfield or refinement	Entry	Explanation and action
	TUPT28	4 to 15	<p><i>Maintenance-oriented group unblocking acknowledgement message timer</i> Enter the time, in seconds, to wait for a maintenance-oriented group UBA message after sending a maintenance-oriented group UBL message.</p> <p>This timer starts when a maintenance-oriented group UBL message is sent and stops when a maintenance-oriented group UBA message is received.</p> <p>When the timer expires, a maintenance-oriented group UBL message is sent.</p> <p>The default value is 10 (10 s).</p>
	TUPT32	4 to 15	<p><i>Hardware-failure-oriented group blocking acknowledgement message timer</i> Enter the time, in seconds, to wait for a hardware-failure-oriented group BLA message, after sending a hardware-failure-oriented group BLO message.</p> <p>This timer starts when a hardware-failure-oriented group BLO message is sent and stops when a hardware-failure-oriented group BLA message is received.</p> <p>When the timer expires, a hardware-failure-oriented group BLO message is sent.</p> <p>The default value is 10 (10 s).</p>

---

**C7UPTMR signaling protocol TUP\_BLUE** (continued)
 

---

**Field descriptions for conditional datafill (Sheet 7 of 9)**

Field	Subfield or refinement	Entry	Explanation and action
	TUPT34	4 to 15	<p><i>Hardware-failure-oriented group unblocking acknowledgement message timer</i></p> <p>Enter the time, in seconds, to wait for a hardware-failure-oriented group UBA message after sending a hardware-failure-oriented group UBL message.</p> <p>This timer starts when a hardware-failure-oriented group UBL message is sent and stops when a hardware-failure-oriented group UBA message is received.</p> <p>When the timer expires, a hardware-failure-oriented group UBL message is sent.</p> <p>The default value is 10 (10 s).</p>
	GSMGRQ	12 to 15	<p><i>General forward setup information message timer</i></p> <p>Enter the time, in seconds, to wait for a general forward setup information message, after sending a general request message.</p> <p>This timer starts when a general request message is sent and stops when a general forward setup information message is received.</p> <p>The default value is 14 (14 s).</p>

---

**C7UPTMR signaling protocol TUP\_BLUE** (continued)

---

**Field descriptions for conditional datafill (Sheet 8 of 9)**

Field	Subfield or refinement	Entry	Explanation and action
	TUPT44	1 to 60	<p><i>Minimum number of digits to commence overlap outpulsing timer</i></p> <p>Enter the time allowed, in seconds, to receive the minimum number of address digits required to commence overlap outpulsing.</p> <p>The timer starts on receipt of an IAM containing less than the minimum number of digits required to commence outpulsing.</p> <p>The timer does not start if the IAM contains an ST signal. The timer is reset each time a subsequent address message (SAM) that fails to increment the total number of digits to equal or exceed the minimum required is received.</p> <p>This timer is terminated if an outgoing trunk is seized.</p> <p>On expiry, the call is taken down. The treatment of the incoming trunk depends on the datafill in table TMTMAP.</p> <p>The default value is 20 (20 s).</p>

---

**C7UPTMR signaling protocol TUP\_BLUE** (continued)
 

---

**Field descriptions for conditional datafill (Sheet 9 of 9)**

Field	Subfield or refinement	Entry	Explanation and action
	TUPT45	1 to 30	<p><i>Completion of address digit collection timer</i> Enter the time allowed, in seconds, to receive the remaining address digits.</p> <p>The timer starts on seizure of an outgoing trunk if there is no indication that all digits have been received (ST digit or 18 digits).</p> <p>The timer is reset each time a SAM that does not contain an ST digit is received.</p> <p>This timer is terminated on receipt of an ST signal, or on the receipt of an address complete message (ACM) or a connection (CON) message that indicates the completion of overlap outpulsing.</p> <p>The expiry of this timer indicates that all address digits related to this call were received, and call processing can proceed.</p> <p>The default value is 4 (4 s).</p> <p><b>Note:</b> Outpulsing enbloc cannot commence until after this timer expires.</p>
OPTIONS (BCS36-)		Q33 or \$	<p><i>Timer options list</i> Enter Q33 for the Q33 option and datafill refinement Q33_TIMER. Otherwise, enter \$.</p>
	Q33_TIMER	10 to 30	<p><i>Q33 timer</i> Enter the time, in seconds, for the Q33 timer.</p>

---

**C7UPTMR signaling protocol TUP\_BLUE** (continued)

---

**C7UPDIR = IC**

If the entry in subfield C7UPDIR is IC, datafill subfield ICPROT and refinements as described below.

**Field descriptions for conditional datafill (Sheet 1 of 7)**

Field	Subfield or refinement	Entry	Explanation and action
	ICPROT	TUP_BLUE	<i>Incoming protocol</i> Enter TUP_BLUE to indicate that the timers are used for signaling between the DMS-300 and a United Kingdom digital international switching center.
	TUPT01	10 to 15	<i>Continuity or continuity failure signal timer</i> Enter the time, in seconds, to wait for a continuity or continuity-failure signal after receiving an initial address message (IAM).  The timer starts when the IAM is received and stops when a continuity or continuity-failure signal is received.  When the timer expires, all equipment is released, a clear-forward and a call-failure signal are sent.  The default value is 13 (13 s).
	TUPT03	4 to 15	<i>Clear-forward signal timer</i> Enter the time, in seconds, to wait for a clear-forward signal after sending an unsuccessful backward setup information message.  This timer starts when an unsuccessful backward setup information message is sent and stops when a clear-forward signal is received.  When the timer expires, a call-failure signal is sent.  The default value is 10 (10 s).



---

**C7UPTMR signaling protocol TUP\_BLUE** (continued)
 

---

**Field descriptions for conditional datafill (Sheet 2 of 7)**

Field	Subfield or refinement	Entry	Explanation and action
	TUPT04	4 to 15	<p><i>Clear-forward signal timer</i> Enter the time, in seconds, to wait for a clear-forward signal after sending a call-failure signal.</p> <p>This timer starts when a call-failure signal is sent and stops when a clear-forward signal is received.</p> <p>When the timer expires, a call-failure signal is sent.</p> <p>The default value is 10 (10 s).</p>
	GSMGRQ	12 to 15	<p><i>General forward setup information message timer</i> Enter the time, in seconds, to wait for a general forward setup information message after sending a general request message.</p> <p>This timer starts when a general request message is sent and stops when a general forward setup information message is received.</p> <p>The default value is 14 (14 s).</p>
	TUPT12	4 to 15	<p><i>Blocking acknowledgement signal timer</i> Enter the time, in seconds, to wait for a blocking acknowledgement (BLA) signal after sending a BLO signal.</p> <p>This timer starts when a BLO signal is sent and stops when a BLA signal is received.</p> <p>When the timer expires, a BLO signal is sent.</p> <p>The default value is 10 (10 s).</p>

---

**C7UPTMR signaling protocol TUP\_BLUE** (continued)

---

**Field descriptions for conditional datafill (Sheet 3 of 7)**

Field	Subfield or refinement	Entry	Explanation and action
	TUPT15	4 to 15	<p><i>Unblocking acknowledgement signal timer</i> Enter the time, in seconds, to wait for an unblocking acknowledgement (UBA) signal after sending an unblocking (UBL) signal.</p> <p>This timer starts when a UBL signal is sent and stops when a UBA signal is received.</p> <p>When the timer expires, a UBL signal is sent.</p> <p>The default value is 10 (10 s).</p>
	TUPT18	4 to 15	<p><i>Unblocking acknowledgement signal timer</i> Enter the time, in seconds, to wait for a release complete (RLC) signal after sending a reset circuit (RSC) signal.</p> <p>This timer starts when an RSC signal is sent and stops when an RLC signal is received.</p> <p>When the timer expires, an RSC signal is sent.</p> <p>The default value is 10 (10 s).</p>
	TUPT21	4 to 15	<p><i>Circuit group reset acknowledgement message timer</i> Enter the time, in seconds, to wait for a circuit group reset acknowledgement message after sending a circuit group reset message.</p> <p>This timer starts when a circuit group reset message is sent and stops when a circuit group reset acknowledgement message is received.</p> <p>When the timer expires, a circuit group reset message is sent.</p> <p>The default value is 10 (10 s).</p>

---

**C7UPTMR signaling protocol TUP\_BLUE** (continued)
 

---

**Field descriptions for conditional datafill (Sheet 4 of 7)**

Field	Subfield or refinement	Entry	Explanation and action
	TUPT26	4 to 15	<p><i>Maintenance-oriented group blocking acknowledgement message timer</i> Enter the time, in seconds, to wait for a maintenance-oriented group BLA after sending a maintenance-oriented group BLO message.</p> <p>This timer starts when a maintenance-oriented group BLO message is sent and stops when a maintenance-oriented group BLA message is received.</p> <p>When the timer expires, a maintenance-oriented group BLO message is sent.</p> <p>The default value is 10 (10 s).</p>
	TUPT28	4 to 15	<p><i>Maintenance-oriented group unblocking acknowledgement message timer</i> Enter the time, in seconds, to wait for a maintenance-oriented group UBA message after sending a maintenance-oriented group UBL message.</p> <p>This timer starts when a maintenance-oriented group UBL message is sent and stops when a maintenance-oriented group UBA message is received.</p> <p>When the timer expires, a maintenance-oriented group UBL message is sent.</p> <p>The default value is 10 (10 s).</p>

---

**C7UPTMR signaling protocol TUP\_BLUE** (continued)

---

**Field descriptions for conditional datafill (Sheet 5 of 7)**

<b>Field</b>	<b>Subfield or refinement</b>	<b>Entry</b>	<b>Explanation and action</b>
	TUPT32	4 to 15	<p><i>Hardware-failure-oriented group blocking acknowledgement message timer</i> Enter the time, in seconds, to wait for a hardware-failure-oriented group BLA message after sending a hardware-failure-oriented group BLO message.</p> <p>This timer starts when a hardware-failure-oriented group BLO message is sent and stops when a hardware-failure-oriented group BLA message is received.</p> <p>When the timer expires, a hardware-failure-oriented group BLO message is sent.</p> <p>The default value is 10 (10 s).</p>
	TUPT34	4 to 15	<p><i>Hardware-failure-oriented group unblocking acknowledgement message timer</i> Enter the time, in seconds, to wait for a hardware-failure-oriented group UBA message after sending a hardware-failure-oriented group UBL message.</p> <p>This timer starts when a hardware-failure-oriented group UBL message is sent and stops when a hardware-failure-oriented group UBA message is received.</p> <p>When the timer expires, a hardware-failure-oriented group UBL message is sent.</p> <p>The default value is 10 (10 s).</p>

---

**C7UPTMR signaling protocol TUP\_BLUE** (continued)
 

---

**Field descriptions for conditional datafill (Sheet 6 of 7)**

Field	Subfield or refinement	Entry	Explanation and action
	TUPT44	1 to 60	<p><i>Minimum number of digits to commence overlap outpulsing timer</i></p> <p>Enter the time allowed, in seconds, to receive the minimum number of address digits required to commence overlap outpulsing.</p> <p>The timer starts on receipt of an IAM containing less than the minimum number of digits required to commence outpulsing.</p> <p>The timer does not start if the IAM contains an ST signal.</p> <p>The timer is reset upon receipt of a subsequent address message (SAM) that fails to increment the total number of digits to equal or exceed the minimum required.</p> <p>The timer is terminated if an outgoing trunk is seized.</p> <p>On expiry, the call is taken down. The treatment of the incoming trunk depends on the datafill in table TMTMAP.</p> <p>The default value is 20 (20 s).</p>

---

**C7UPTMR signaling protocol TUP\_BLUE** (continued)

---

**Field descriptions for conditional datafill (Sheet 7 of 7)**

Field	Subfield or refinement	Entry	Explanation and action
	TUPT45	1 to 30	<p><i>Completion of address digit collection timer</i> Enter the time allowed, in seconds, to receive the remaining address digits.</p> <p>The timer starts on seizure of an outgoing trunk if there is no indication that all digits were received (ST digit or 18 digits).</p> <p>The timer is reset each time a SAM that does not contain an ST digit is received.</p> <p>The timer stops when an ST signal, or an ACM or continuity test (COT) message that indicates that completion of overlap outpulsing, is received.</p> <p>If this timer expires, all address digits related to this call were received and call processing can proceed.</p> <p>The default value is 4 (4 s).</p> <p><b>Note:</b> Outpulsing enbloc cannot commence until after this timer expires.</p>
OPTIONS (BCS36-)		Q33 or \$	<p><i>Timer options list</i> Enter Q33 for the Q33 option and datafill refinement Q33_TIMER. Otherwise, enter \$.</p>
	Q33_TIMER	10 to 30	<p><i>Q33 timer</i> Enter the time, in seconds, for the Q33 timer.</p>

---

**C7UPTMR signaling protocol TUP\_BLUE** (continued)
 

---

**C7UPDIR = OG**

If the entry subfield C7UPDIR is OG, datafill subfield OGPROT and refinements as described below.

**Field descriptions for conditional datafill (Sheet 1 of 6)**

Field	Subfield or refinement	Entry	Explanation and action
	OGPROT	TUP_BLUE	<i>Outgoing protocol</i> Enter TUP_BLUE to indicate that the timers are used for signaling between the DMS-300 and a United Kingdom digital international switching center.
	TUPT02	20 to 30	<i>Address complete signal timer</i> Enter the time, in seconds, to wait for an address complete signal after sending the latest address message.  This timer starts when an address message is sent and stops when an address complete signal is received.  When the timer expires, all equipment is released and the connection is cleared forward.  The default value is 25 (25 s).
	TUPT06	4 to 15	<i>Release guard signal timer</i> Enter the time, in seconds, to wait for a release guard signal after sending a clear forward signal.  This timer starts when a clear forward signal is sent and stops when a release guard signal is received.  When the timer expires, a clear forward signal is sent.  The default value is 10 (10 s).

---

**C7UPTMR signaling protocol TUP\_BLUE** (continued)
 

---

**Field descriptions for conditional datafill (Sheet 2 of 6)**

Field	Subfield or refinement	Entry	Explanation and action
	TUPT08	1 to 2	<p><i>Backward check tone timer</i> Enter the time, in seconds, to wait for a backward check tone after sending a forward check tone.</p> <p>This timer starts when a forward check tone is sent and stops when a backward check tone is received.</p> <p>When the timer expires, a forward check tone is sent.</p> <p>The default value is 2 (2 s).</p>
	TUPT09	1 to 10	<p><i>First time continuity recheck timer</i> Enter the time, in seconds, to wait before the first repeat attempt of the continuity check after detecting the initial continuity check failure.</p> <p>This timer starts when a continuity check failure is detected and stops when the first repeat continuity check is made.</p> <p>When the timer expires, a repeat continuity check is sent.</p> <p>The default value is 5 (5 s).</p>
	TUPT10	60 to 180	<p><i>Multiple continuity recheck timer</i> Enter the time, in seconds, to wait before making a second (or greater) attempt of the continuity check after detecting a continuity check failure on the first (or greater) repeat continuity check.</p> <p>This timer starts when the first (or greater) repeat continuity check failure is detected and stops when continuity is detected.</p> <p>When the timer expires, another repeat continuity check is sent.</p> <p>The default value is 870 (870 s).</p>



---

**C7UPTMR signaling protocol TUP\_BLUE** (continued)
 

---

**Field descriptions for conditional datafill (Sheet 3 of 6)**

Field	Subfield or refinement	Entry	Explanation and action
	TUPT12	4 to 15	<p><i>Blocking acknowledgement signal timer</i> Enter the time, in seconds, to wait for a blocking acknowledgement (BLA) signal after sending a blocking (BLO) signal.</p> <p>This timer starts when a BLO signal is sent and stops when a BLA signal is received.</p> <p>When the timer expires, a BLO signal is sent.</p> <p>The default value is 10 (10 s).</p>
	TUPT15	4 to 15	<p><i>Unblocking acknowledgement signal timer</i> Enter the time, in seconds, to wait for an unblocking acknowledgement (UBA) signal after sending an unblocking (UBL) signal.</p> <p>This timer starts when a UBL signal is sent and stops when a UBA signal is received.</p> <p>When the timer expires, a UBL signal is sent.</p> <p>The default value is 10 (10 s).</p>
	TUPT18	4 to 15	<p><i>Unblocking acknowledgement signal timer</i> Enter the time, in seconds, to wait for a release complete (RLC) signal after sending a reset circuit (RSC) signal.</p> <p>This timer starts when an RSC signal is sent and stops when an RLC signal is received.</p> <p>When the timer expires, an RSC signal is sent.</p> <p>The default value is 10 (10 s).</p>

---

**C7UPTMR signaling protocol TUP\_BLUE** (continued)
 

---

**Field descriptions for conditional datafill (Sheet 4 of 6)**

Field	Subfield or refinement	Entry	Explanation and action
	TUPT21	4 to 15	<p><i>Circuit group reset acknowledgement message timer</i>            Enter the time, in seconds, to wait for a circuit group reset acknowledgement message after sending a circuit group reset message.</p> <p>This timer starts when a circuit group reset message is sent and stops when a circuit group reset acknowledgement message is received.</p> <p>When the timer expires, a circuit group reset message is sent.</p> <p>The default value is 10 (10 s).</p>
	TUPT26	4 to 15	<p><i>Maintenance-oriented group blocking acknowledgement message timer</i>            Enter the time, in seconds, to wait for a maintenance-oriented group BLA message after sending a maintenance-oriented group BLO message.</p> <p>This timer starts when a maintenance-oriented group BLO message is sent and stops when a maintenance-oriented group BLA message is received.</p> <p>When the timer expires, a maintenance-oriented group BLO message is sent.</p> <p>The default value is 10 (10 s).</p>

---

**C7UPTMR signaling protocol TUP\_BLUE** (continued)
 

---

**Field descriptions for conditional datafill (Sheet 5 of 6)**

Field	Subfield or refinement	Entry	Explanation and action
	TUPT28	4 to 15	<p><i>Maintenance-oriented group unblocking acknowledgement message timer</i> Enter the time, in seconds, to wait for a maintenance-oriented group UBA message after sending a maintenance-oriented group UBL message.</p> <p>This timer starts when a maintenance-oriented group UBL message is sent and stops when a maintenance-oriented group UBA message is received.</p> <p>When the timer expires, a maintenance-oriented group UBL message is sent.</p> <p>The default value is 10 (10 s).</p>
	TUPT32	4 to 15	<p><i>Hardware-failure-oriented group blocking acknowledgement message timer</i> Enter the time, in seconds, to wait for a hardware-failure-oriented group BLA message after sending a hardware-failure-oriented group BLO message.</p> <p>This timer starts when a hardware-failure-oriented group BLO message is sent and stops when a hardware-failure-oriented group BLA message is received.</p> <p>When the timer expires, a hardware-failure-oriented group BLO message is sent.</p> <p>The default value is 10 (10 s).</p>

---

**C7UPTMR signaling protocol TUP\_BLUE** (continued)
 

---

**Field descriptions for conditional datafill (Sheet 6 of 6)**

Field	Subfield or refinement	Entry	Explanation and action
	TUPT34	4 to 15	<p><i>Hardware-failure-oriented group unblocking acknowledgement message timer</i></p> <p>Enter the time, in seconds, to wait for a hardware-failure-oriented group UBA message after sending a hardware-failure-oriented group UBL message.</p> <p>This timer starts when a hardware-failure-oriented group UBL message is sent and stops when a hardware-failure-oriented group UBA message is received.</p> <p>When the timer expires, a hardware-failure-oriented group UBL message is sent.</p> <p>The default value is 10 (10 s).</p>
	GSMGRQ	12 to 15	<p><i>General forward setup information message timer</i></p> <p>Enter the time, in seconds, to wait for a general forward setup information message after sending a general request message.</p> <p>This timer starts when a general request message is sent and stops when a general forward setup information message is received.</p> <p>The default value is 14 (14 s).</p>
OPTIONS (BCS36-)		\$	<p><i>Timer options list</i></p> <p>No refinements defined. Enter \$.</p>

**Datafill example**

The following example shows sample datafill for table C7UPTMR signaling protocol TUP\_BLUE.

---

## C7UPTMR signaling protocol TUP\_BLUE (end)

---

### MAP display example for table C7UPTMR signaling protocol TUP\_BLUE

TMRKEY C7UPDIR		TMRS
OPTIONS		
OGTUP_BLUE	OG	TUP_BLUE 25 10 2 5 870 10 10 10
10 10 10 10 10 14	\$	

---

## C7UPTMR signaling protocol TUPPLUS

---

### BTUP internetworking with TUP+ or other Signaling 7 protocols

Signaling protocol TUPPLUS is used for interworking BTUP with telephone user part plus (TUP+) or any other signaling 7 protocol.

### Datafill

The following table lists the datafill for table C7UPTMR signaling protocol TUPPLUS.

### Field descriptions

Field	Subfield or refinement	Entry	Explanation and action
	PROT	see subfields	<p><i>Protocol</i>If the entry in field C7UPDIR is 2W, this subfield consists of subfield BWPROT described in Section "C7UPDIR = 2W".</p> <p>If the entry in field C7UPDIR is IC, this subfield consists of subfield ICPROT described in Section "C7UPDIR = IC".</p> <p>If the entry in field C7UPDIR is OG, this subfield consists of subfield OGPROT described in Section "C7UPDIR = OG".</p>

## C7UPTMR signaling protocol TUPPLUS (continued)

### C7UPDIR = 2W

If the entry subfield C7UPDIR is 2W, datafill subfield BWPROT and refinements as described below.

#### Field descriptions for conditional datafill (Sheet 1 of 9)

Field	Subfield or refinement	Entry	Explanation and action
	BWPROT	TUPPLUS	<p><i>Two-way protocol</i> Enter TUPPLUS to indicate that the timers are used for telephone user part plus (TUP+) trunks.</p>
	TUPPT01	10 to 15	<p><i>Continuity or continuity failure signal timer</i> Enter the time, in seconds, to wait for a continuity or continuity-failure signal after receiving an initial address message (IAM).  The timer starts when the IAM is received and stops when a continuity or continuity-failure signal is received.  When the timer expires, all equipment is released, a clear forward and a call-failure signal is sent.  The default value is 13 (13 s).</p>
	TUPPT02	20 to 30	<p><i>Address complete signal timer</i> Enter the time, in seconds, to wait for an address complete signal after sending the latest address message.  This timer starts when an address message is sent and stops when an address complete signal is received.  When the timer expires, all equipment is released and the connection is cleared forward.  The default value is 25 (25 s).</p>

---

**C7UPTMR signaling protocol TUPPLUS** (continued)

---

**Field descriptions for conditional datafill (Sheet 2 of 9)**

Field	Subfield or refinement	Entry	Explanation and action
	TUPPT03	4 to 15	<p><i>Clear-forward signal timer</i> Enter the time, in seconds, to wait for a clear-forward signal after sending an unsuccessful backward setup information message.</p> <p>This timer starts when an unsuccessful backward setup information message is sent and stops when a clear-forward signal is received.</p> <p>When the timer expires, a call-failure signal is sent.</p> <p>The default value is 10 (10 s).</p>
	TUPPT04	4 to 15	<p><i>Clear-forward signal timer</i> Enter the time, in seconds, to wait for a clear-forward signal after sending a call-failure signal.</p> <p>This timer starts when a call-failure signal is sent and stops when a clear-forward signal is received.</p> <p>When the timer expires, a call-failure signal is sent.</p> <p>The default value is 10 (10 s).</p>
	TUPPT06	4 to 15	<p><i>Release guard signal timer</i> Enter the time, in seconds, to wait for a release guard signal after sending a clear forward signal.</p> <p>This timer starts when a clear forward signal is sent and stops when a release guard signal is received.</p> <p>When the timer expires, a clear forward signal is sent.</p> <p>The default value is 10 (10 s).</p>



## C7UPTMR signaling protocol TUPPLUS (continued)

### Field descriptions for conditional datafill (Sheet 3 of 9)

Field	Subfield or refinement	Entry	Explanation and action
	TUPPT08	1 to 2	<p><i>Backward check tone timer</i> Enter the time, in seconds, to wait for a backward check tone after sending a forward check tone.</p> <p>This timer starts when a forward check tone is sent and stops when a backward check tone is received.</p> <p>When the timer expires, a forward check tone is sent.</p> <p>The default value is 2 (2 s).</p>
	TUPPT09	1 to 10	<p><i>First time continuity recheck timer</i> Enter the time, in seconds, to wait before the first repeat attempt of the continuity check after detecting the initial continuity check failure.</p> <p>This timer starts when a continuity check failure is detected and stops when the first repeat continuity check is made.</p> <p>When the timer expires, a repeat continuity check is sent.</p> <p>The default value is 5 (5 s).</p>
	TUPPT10	60 to 1800	<p><i>Multiple continuity recheck timer</i> Enter the time, in seconds, to wait before making a second (or greater) attempt of the continuity check after detecting a continuity check failure on the first (or greater) repeat continuity check.</p> <p>This timer starts when the first (or greater) repeat continuity check failure is detected and stops when continuity is detected.</p> <p>When the timer expires, another repeat continuity check is sent.</p> <p>The default value is 870 (870 s).</p>

---

**C7UPTMR signaling protocol TUPPLUS** (continued)

---

**Field descriptions for conditional datafill (Sheet 4 of 9)**

Field	Subfield or refinement	Entry	Explanation and action
	TUPPT12	4 to 15	<p><i>Blocking acknowledgement signal timer</i> Enter the time, in seconds, to wait for a blocking acknowledgement (BLA) signal after sending a blocking (BLO) signal.</p> <p>This timer starts when a BLO signal is sent and stops when a BLA signal is received.</p> <p>When the timer expires, a BLO signal is sent.</p> <p>The default value is 10 (10 s).</p>
	TUPPT15	4 to 15	<p><i>Unblocking acknowledgement signal timer</i> Enter the time, in seconds, to wait for an unblocking acknowledgement (UBA) signal after sending an unblocking (UBL) signal.</p> <p>This timer starts when a UBL signal is sent and stops when an UBA signal is received.</p> <p>When the timer expires, an UBL signal is sent.</p> <p>The default value is 10 (10 s).</p>
	TUPPT18	4 to 15	<p><i>Unblocking acknowledgement signal timer</i> Enter the time, in seconds, to wait for a release complete signal after sending a reset circuit (RSC) signal.</p> <p>This timer starts when an RSC signal is sent and stops when a release complete signal is received.</p> <p>When the timer expires, an RSC signal is sent.</p> <p>The default value is 10 (10 s).</p>

## C7UPTMR signaling protocol TUPPLUS (continued)

### Field descriptions for conditional datafill (Sheet 5 of 9)

Field	Subfield or refinement	Entry	Explanation and action
	TUPPT21	4 to 15	<p><i>Circuit group reset acknowledgement message timer</i> Enter the time, in seconds, to wait for a circuit group reset acknowledgement message after sending a circuit group reset message.</p> <p>This timer starts when a circuit group reset message is sent and stops when a circuit group reset acknowledgement message is received.</p> <p>When the timer expires, a circuit group reset message is sent.</p> <p>The default value is 10 (10 s).</p>
	TUPPT26	4 to 15	<p><i>Maintenance-oriented group blocking acknowledgement message timer</i> Enter the time, in seconds, to wait for a maintenance-oriented group BLA message after sending a maintenance-oriented group BLO message.</p> <p>This timer starts when a maintenance-oriented group BLO message is sent and stops when a maintenance-oriented group BLA message is received.</p> <p>When the timer expires, a maintenance-oriented group BLO message is sent.</p> <p>The default value is 10 (10 s).</p>

---

**C7UPTMR signaling protocol TUPPLUS** (continued)

---

**Field descriptions for conditional datafill (Sheet 6 of 9)**

Field	Subfield or refinement	Entry	Explanation and action
	TUPPT28	4 to 15	<p><i>Maintenance-oriented group unblocking acknowledgement message timer</i> Enter the time, in seconds, to wait for a maintenance-oriented group UBA message after sending a maintenance-oriented group UBL message.</p> <p>This timer starts when a maintenance-oriented group UBL message is sent and stops when a maintenance-oriented group UBA message is received.</p> <p>When the timer expires, a maintenance-oriented group UBL message is sent.</p> <p>The default value is 10 (10 s).</p>
	TUPPT32	4 to 15	<p><i>Hardware-failure-oriented group blocking acknowledgement message timer</i> Enter the time, in seconds, to wait for a hardware-failure-oriented group BLA message after sending a hardware-failure-oriented group BLO message.</p> <p>This timer starts when a hardware-failure-oriented group BLO message is sent and stops when a hardware-failure-oriented group BLA message is received.</p> <p>When the timer expires, a hardware-failure-oriented group BLO message is sent.</p> <p>The default value is 10 (10 s).</p>

## C7UPTMR signaling protocol TUPPLUS (continued)

### Field descriptions for conditional datafill (Sheet 7 of 9)

Field	Subfield or refinement	Entry	Explanation and action
	TUPPT34	4 to 15	<p><i>Hardware-failure-oriented group unblocking acknowledgement message timer</i></p> <p>Enter the time, in seconds, to wait for a hardware-failure-oriented group UBA message after sending a hardware-failure-oriented group UBO message.</p> <p>This timer starts when a hardware-failure-oriented group UBL message is sent and stops when a hardware-failure-oriented group UBA message is received.</p> <p>When the timer expires, a hardware-failure-oriented group UBL message is sent.</p> <p>The default value is 10 (10 s).</p>
	GSMGRQ	12 to 15	<p><i>General forward setup information message timer</i></p> <p>Enter the time, in seconds, to wait for a general forward setup information message after sending a general request message.</p> <p>This timer starts when a general request message is sent and stops when a general forward setup information message is received.</p> <p>The default value is 14 (14 s).</p>

---

**C7UPTMR signaling protocol TUPPLUS** (continued)
 

---

**Field descriptions for conditional datafill (Sheet 8 of 9)**

Field	Subfield or refinement	Entry	Explanation and action
	TUPPT44	1 to 60	<p><i>Minimum number of digits to commence overlap outpulsing timer</i></p> <p>Enter the time allowed, in seconds, to receive the minimum number of address digits required to commence overlap outpulsing.</p> <p>The timer starts on receipt of an IAM containing less than the minimum number of digits required to commence outpulsing.</p> <p>The timer does not start if the IAM contains an ST signal.</p> <p>The timer is reset each time a subsequent address message (SAM) that fails to increment the total number of digits to equal or exceed the minimum required is received.</p> <p>The timer is terminated if an outgoing trunk is seized.</p> <p>On expiry, the call is taken down. The treatment of the incoming trunk depends on the datafill in table TMTMAP.</p> <p>The default value is 20 (20 s).</p>

## C7UPTMR signaling protocol TUPPLUS (continued)

### Field descriptions for conditional datafill (Sheet 9 of 9)

Field	Subfield or refinement	Entry	Explanation and action
	TUPPT45	1 to 30	<p><i>Completion of address digit collection timer</i> Enter the time allowed, in seconds, to receive the remaining address digits.</p> <p>The timer starts on seizure of an outgoing trunk if there is no indication that all digits were received (ST digit or 18 digits).</p> <p>The timer is reset each time a SAM that does not contain an ST digit is received.</p> <p>The timer is terminated on receipt of an ST signal, or on the receipt of an answer complete message (ACM) or a connection (CON) message that indicates that completion of overlap outpulsing.</p> <p>The expiry of this timer indicates all address digits related to this call were received, and call processing can proceed.</p> <p>The default value is 4 (4 s).</p> <p><b>Note:</b> Outpulsing enbloc cannot commence until after this timer expires.</p>
OPTIONS (BCS36-)		Q33 or \$	<p><i>Timer options list</i> Enter Q33 for the Q33 option and datafill refinement Q33_TIMER. Otherwise, enter \$.</p>
	Q33_TIMER	10 to 30	<p><i>Q33 timer</i> Enter the time, in seconds, for the Q33 timer.</p>

---

**C7UPTMR signaling protocol TUPPLUS** (continued)

---

**C7UPDIR = IC**

If the entry in subfield C7UPDIR is IC, datafill subfield ICPROT and refinements as described below.

**Field descriptions for conditional datafill (Sheet 1 of 6)**

Field	Subfield or refinement	Entry	Explanation and action
	ICPROT	TUPPLUS	<i>Incoming protocol</i> Enter TUPPLUS to indicate that the timers are used for telephone user part (TUP+) trunks.
	TUPPT01	10 to 15	<i>Continuity or continuity failure signal timer</i> Enter the time, in seconds, to wait for a continuity or continuity-failure signal after receiving an initial address message (IAM).  The timer starts when the IAM is received and stops when a continuity or continuity-failure signal is received.  When the timer expires, all equipment is released, a clear forward (CLF) and a call-failure (CFL) signal is sent.  The default value is 13 (13 s).
	TUPPT03	4 to 15	<i>Clear-forward signal timer</i> Enter the time, in seconds, to wait for a CLF signal after sending an unsuccessful backward setup information message.  This timer starts when an unsuccessful backward setup information message is sent and stops when a CLF signal is received.  When the timer expires, a CFL signal is sent.  The default value is 10 (10 s).
	TUPPT04	4 to 15	<i>Clear-forward signal timer</i> Enter the time, in seconds, to wait for a CLF signal after sending a CFL signal.  This timer starts when a CFL signal is sent and stops when a CLF signal is received.  When the timer expires, a CFL signal is sent.  The default value is 10 (10 s).



## C7UPTMR signaling protocol TUPPLUS (continued)

### Field descriptions for conditional datafill (Sheet 2 of 6)

Field	Subfield or refinement	Entry	Explanation and action
	GSMGRQ	12 to 15	<p><i>General forward setup information message timer</i> Enter the time, in seconds, to wait for a general forward setup information message after sending a general request message.</p> <p>This timer starts when a general request message is sent and stops when a general forward setup information message is received.</p> <p>The default value is 14 (14 s).</p>
	TUPPT12	4 to 15	<p><i>Blocking acknowledgement signal timer</i> Enter the time, in seconds, to wait for a blocking acknowledgement (BLA) signal after sending a blocking (BLO) signal.</p> <p>This timer starts when a BLO signal is sent and stops when a BLA signal is received.</p> <p>When the timer expires, a BLO signal is sent.</p> <p>The default value is 10 (10 s).</p>
	TUPPT15	4 to 15	<p><i>Unblocking acknowledgement signal timer</i> Enter the time, in seconds, to wait for an unblocking acknowledgement (UBA) signal after sending an unblocking (UBL) signal.</p> <p>This timer starts when a UBL signal is sent and stops when a UBA signal is received.</p> <p>When the timer expires, a UBL signal is sent.</p> <p>The default value is 10 (10 s).</p>
	TUPPT18	4 to 15	<p><i>Unblocking acknowledgement signal timer</i> Enter the time, in seconds, to wait for a release complete (RLC) signal after sending a reset circuit (RSC) signal.</p> <p>This timer starts when an RSC signal is sent and stops when an RLC signal is received.</p> <p>When the timer expires, an RSC signal is sent.</p> <p>The default value is 10 (10 s).</p>

---

**C7UPTMR signaling protocol TUPPLUS** (continued)

---

**Field descriptions for conditional datafill (Sheet 3 of 6)**

Field	Subfield or refinement	Entry	Explanation and action
	TUPPT21	4 to 15	<p><i>Circuit group reset acknowledgement message timer</i>  Enter the time, in seconds, to wait for a circuit group reset acknowledgement message after sending a circuit group reset message.</p> <p>This timer starts when a circuit group reset message is sent and stops when a circuit group reset acknowledgement message is received.</p> <p>When the timer expires, a circuit group reset message is sent.</p> <p>The default value is 10 (10 s).</p>
	TUPPT26	4 to 15	<p><i>Maintenance-oriented group blocking acknowledgement message timer</i>  Enter the time, in seconds, to wait for a maintenance-oriented group blocking acknowledgement (BLA) message after sending a maintenance-oriented group blocking (BLO) message.</p> <p>This timer starts when a maintenance-oriented group BLO message is sent and stops when a maintenance-oriented group BLA message is received.</p> <p>When the timer expires, a maintenance-oriented group BLO message is sent.</p> <p>The default value is 10 (10 s).</p>

## C7UPTMR signaling protocol TUPPLUS (continued)

### Field descriptions for conditional datafill (Sheet 4 of 6)

Field	Subfield or refinement	Entry	Explanation and action
	TUPPT28	4 to 15	<p><i>Maintenance-oriented group unblocking acknowledgement message timer</i> Enter the time, in seconds, to wait for a maintenance-oriented group (UBA) message after sending a maintenance-oriented group (UBL) message.</p> <p>This timer starts when a maintenance-oriented group (UBL) message is sent and stops when a maintenance-oriented group UBA message is received.</p> <p>When the timer expires, a maintenance-oriented group UBL message is sent.</p> <p>The default value is 10 (10 s).</p>
	TUPPT32	4 to 15	<p><i>Hardware-failure-oriented group blocking acknowledgement message timer</i> Enter the time, in seconds, to wait for a hardware-failure-oriented group BLA message after sending a hardware-failure-oriented group BLO message.</p> <p>This timer starts when a hardware-failure-oriented group BLO message is sent and stops when a hardware-failure-oriented group BLA message is received.</p> <p>When the timer expires, a hardware-failure-oriented group BLO message is sent.</p> <p>The default value is 10 (10 s).</p>

## C7UPTMR signaling protocol TUPPLUS (continued)

### Field descriptions for conditional datafill (Sheet 5 of 6)

Field	Subfield or refinement	Entry	Explanation and action
	TUPPT34	4 to 15	<p><i>Hardware-failure-oriented group unblocking acknowledgement message timer</i> Enter the time, in seconds, to wait for a hardware-failure-oriented group UBA message after sending a hardware-failure-oriented group UBL message.</p> <p>This timer starts when a hardware-failure-oriented group UBL message is sent and stops when a hardware-failure-oriented group UBA message is received.</p> <p>When the timer expires, a hardware-failure-oriented group UBL message is sent.</p> <p>The default value is 10 (10 s).</p>
	TUPPT44	1 to 60	<p><i>Minimum number of digits to commence overlap outpulsing timer</i> Enter the time allowed, in seconds, to receive the minimum number of address digits required to commence overlap outpulsing.</p> <p>The timer starts on receipt of an IAM containing less than the minimum number of digits required to commence outpulsing.</p> <p>The timer does not start if the IAM contains an ST signal.</p> <p>The timer is reset each time a subsequent address message (SAM) that fails to increment the total number of digits to equal or exceed the minimum required is received.</p> <p>The timer is terminated if an outgoing trunk is seized.</p> <p>On expiry, the call is taken down. The treatment of the incoming trunk depends on the datafill in table TMTMAP.</p> <p>The default value is 20 (20 s).</p>

## C7UPTMR signaling protocol TUPPLUS (continued)

### Field descriptions for conditional datafill (Sheet 6 of 6)

Field	Subfield or refinement	Entry	Explanation and action
	TUPPT45	1 to 30	<p><i>Completion of address digit collection timer</i> Enter the time allowed, in seconds, to receive the remaining address digits.</p> <p>The timer starts on seizure of an outgoing trunk if there is no indication that all digits were received (ST digit or 18 digits).</p> <p>The timer is reset each time a SAM that does not contain an ST digit is received.</p> <p>The timer is terminated on receipt of an ST signal, or on the receipt of an address complete message (ACM) or connection (CON) message that indicates that completion of overlap outpulsing.</p> <p>The expiry of this timer indicates that all address digits related to this call were received, and call processing can proceed.</p> <p>The default value is 4 (4 s).</p> <p><b>Note:</b> Outpulsing enbloc cannot commence until after this timer expires.</p>
OPTIONS (BCS36-)		Q33 or \$	<p><i>Timer options list</i> Enter Q33 for the Q33 option and datafill refinement Q33_TIMER. Otherwise, enter \$.</p>
	Q33_TIMER	10 to 30	<p><i>Q33 timer</i> Enter the time, in seconds, for the Q33 timer.</p>

---

**C7UPTMR signaling protocol TUPPLUS** (continued)

---

**C7UPDIR = OG**

If the entry subfield C7UPDIR is OG, datafill subfield OGPROT and refinements as described below.

**Field descriptions for conditional datafill (Sheet 1 of 6)**

Field	Subfield or refinement	Entry	Explanation and action
	OGPROT	TUPPLUS	<i>Outgoing protocol</i> Enter TUPPLUS to indicate that the timers are used for telephone user part plus (TUP+) trunks.
	TUPPT02	20 to 30	<i>Address complete signal timer</i> Enter the time, in seconds, to wait for an address complete signal after sending the latest address message.  This timer starts when an address message is sent and stops when an address complete signal is received.  When the timer expires, all equipment is released and the connection is cleared forward.  The default value is 25 (25 s).
	TUPPT06	4 to 15	<i>Release guard signal timer</i> Enter the time, in seconds, to wait for a release guard signal after sending a clear forward signal.  This timer starts when a clear forward signal is sent and stops when a release guard signal is received.  When the timer expires, a clear forward signal is sent.  The default value is 10 (10 s).

## C7UPTMR signaling protocol TUPPLUS (continued)

### Field descriptions for conditional datafill (Sheet 2 of 6)

Field	Subfield or refinement	Entry	Explanation and action
	TUPPT08	1 to 2	<p><i>Backward check tone timer</i> Enter the time, in seconds, to wait for a backward check tone after sending a forward check tone.</p> <p>This timer starts when a forward check tone is sent and stops when a backward check tone is received.</p> <p>When the timer expires, a forward check tone is sent.</p> <p>The default value is 2 (2 s).</p>
	TUPPT09	1 to 10	<p><i>First time continuity recheck timer</i> Enter the time, in seconds, to wait before the first repeat attempt of the continuity check after detecting the initial continuity check failure.</p> <p>This timer starts when a continuity check failure is detected and stops when the first repeat continuity check is made.</p> <p>When the timer expires, a repeat continuity check message is sent.</p> <p>The default value is 5 (5 s).</p>
	TUPPT10	60 to 1800	<p><i>Multiple continuity recheck timer</i> Enter the time, in seconds, to wait before making a second (or greater) attempt of the continuity check after detecting a continuity check failure on the first (or greater) repeat continuity check.</p> <p>This timer starts when the first (or greater) repeat continuity check failure is detected and stops when continuity is detected.</p> <p>When the timer expires, another repeat continuity check message is sent.</p> <p>The default value is 870 (870 s).</p>

---

**C7UPTMR signaling protocol TUPPLUS** (continued)

---

**Field descriptions for conditional datafill (Sheet 3 of 6)**

Field	Subfield or refinement	Entry	Explanation and action
	TUPPT12	4 to 15	<p><i>Blocking acknowledgement signal timer</i> Enter the time, in seconds, to wait for a blocking acknowledgement (BLA) signal after sending a blocking (BLO) signal.</p> <p>This timer starts when a BLO signal is sent and stops when a BLA signal is received.</p> <p>When the timer expires, a BLO signal is sent.</p> <p>The default value is 10 (10 s).</p>
	TUPPT15	4 to 15	<p><i>Unblocking acknowledgement signal timer</i> Enter the time, in seconds, to wait for an unblocking acknowledgement (UBA) signal after sending an unblocking (UBL) signal.</p> <p>This timer starts when a UBL signal is sent and stops when a UBA signal is received.</p> <p>When the timer expires, a UBL signal is sent.</p> <p>The default value is 10 (10 s).</p>
	TUPPT18	4 to 15	<p><i>Unblocking acknowledgement signal timer</i> Enter the time, in seconds, to wait for a release complete (RLC) signal after sending a reset circuit (RSC) signal.</p> <p>This timer starts when a RSC signal is sent and stops when an RLC signal is received.</p> <p>When the timer expires, a RSC signal is sent.</p> <p>The default value is 10 (10 s).</p>



## C7UPTMR signaling protocol TUPPLUS (continued)

### Field descriptions for conditional datafill (Sheet 4 of 6)

Field	Subfield or refinement	Entry	Explanation and action
	TUPPT21	4 to 15	<p><i>Circuit group reset acknowledgement message timer</i> Enter the time, in seconds, to wait for a circuit group reset acknowledgement message after sending a circuit group reset message.</p> <p>This timer starts when a circuit group reset message is sent and stops when a circuit group reset acknowledgement message is received.</p> <p>When the timer expires, a circuit group reset message is sent.</p> <p>The default value is 10 (10 s).</p>
	TUPPT26	4 to 15	<p><i>Maintenance-oriented group blocking acknowledgement message timer</i> Enter the time, in seconds, to wait for a maintenance-oriented group BLA message after sending a maintenance-oriented group BLO message.</p> <p>This timer starts when a maintenance-oriented group BLO message is sent and stops when a maintenance-oriented group BLA message is received.</p> <p>When the timer expires, a maintenance-oriented group BLO message is sent.</p> <p>The default value is 10 (10 s).</p>

---

**C7UPTMR signaling protocol TUPPLUS** (continued)
 

---

**Field descriptions for conditional datafill (Sheet 5 of 6)**

Field	Subfield or refinement	Entry	Explanation and action
	TUPPT28	4 to 15	<p><i>Maintenance-oriented group unblocking acknowledgement message timer</i> Enter the time, in seconds, to wait for a maintenance-oriented group UBA message after sending a maintenance-oriented group UBL message.</p> <p>This timer starts when a maintenance-oriented group UBL message is sent and stops when a maintenance-oriented group UBA message is received.</p> <p>When the timer expires, a maintenance-oriented group UBL message is sent.</p> <p>The default value is 10 (10 s).</p>
	TUPPT32	4 to 15	<p><i>Hardware-failure-oriented group blocking acknowledgement message timer</i> Enter the time, in seconds, to wait for a hardware-failure-oriented group BLA message after sending a hardware-failure-oriented group BLO message.</p> <p>This timer starts when a hardware-failure-oriented group BLO message is sent and stops when a hardware-failure-oriented group BLA message is received.</p> <p>When the timer expires, a hardware-failure-oriented group BLO message is sent.</p> <p>The default value is 10 (10 s).</p>

**C7UPTMR signaling protocol TUPPLUS** (continued)

## Field descriptions for conditional datafill (Sheet 6 of 6)

Field	Subfield or refinement	Entry	Explanation and action
	TUPPT34	4 to 15	<p><i>Hardware-failure-oriented group unblocking acknowledgement message timer</i></p> <p>Enter the time, in seconds, to wait for a hardware-failure-oriented group UBA message after sending a hardware-failure-oriented group UBL message.</p> <p>This timer starts when a hardware-failure-oriented group UBL message is sent and stops when a hardware-failure-oriented group UBA message is received. When the timer expires, a hardware-failure-oriented group UBL message is sent.</p> <p>The default value is 10 (10 s).</p>
	GSMGRQ	12 to 15	<p><i>General forward setup information message timer</i></p> <p>Enter the time, in seconds, to wait for a general forward setup information message after sending a general request message.</p> <p>This timer starts when a general request message is sent and stops when a general forward setup information message is received.</p> <p>The default value is 14 (14 s).</p>
OPTIONS (BCS36-)		\$	<p><i>Timer options list</i></p> <p>No refinements defined. Enter \$.</p>

**Datafill example**

The following example shows sample datafill for table C7UPTMR signaling protocol TUPPLUS.



## CALLCHR

---

### Table name

Call Characteristic Table

### Functional description

Table CALLCHR allows the operating company to assign names or meanings to call characteristics. An example is Satellite (SAT).

The following call characteristics are available:

- Digital data (DIGDATA) is only necessary if the incoming trunk group is a tandem type digital trunk. The trunk connects to an electronic tandem network (ETN) switching unit.
- The SAT specifies if a satellite trunk is in the connection.

Tables DIGMAN, IBNRTE, PACMAN, or TRKGRP (trunk group types IBNTI and IBNT2) assign the call characteristics.

### Datafill sequence and meaning

You do not need to enter data in other tables before you enter data in table CALLCHR.

### Table size

0 to 256 tuples

### Datafill

Datafill for table CALLCHR appears in the following table.

#### Field descriptions

Field	Subfield or refinement	Entry	Explanation and action
CHRNAME		DIGDATA or SAT	<i>Characteristic name</i> Enter DIGDATA for digital data or SAT for satellite.

### Datafill example

Sample datafill for table CALLCHR appears in the following example.

---

**CALLCHR** (end)

---

**MAP display example for table CALLCHR**

CHRNAME
DIGDATA
SAT

## CAMACSW

---

### Table name

CAMA Call Waiting Lamp Threshold Table

### Overview

The following table lists the CAMA position tables.

#### CAMA position tables

Table	Table name
CAMACSW	CAMA Call Waiting Lamp Threshold Table
CAMACSWs	CAMA Call Waiting and Suspension Circuit Table
CPOS	CAMA Position Trunk Circuit Table
CPOSTIME	CAMA Position Timing Table

### Functional description

Table CAMACSW indicates the various lamp threshold settings and the maximum number of calls that can queue for CAMA positions.

### Datafill sequence and implications

The following tables must be datafilled before table CAMACSW.

- CLLI
- CPOS
- DATASIZE

### Table size

Setting field SIZE in table DATASIZE for table CPOS and doing a cold restart automatically allocates memory for this table. Memory allocation is equal to the number of CAMA positions plus one.

Field TRKGRSIZ for code CPOS in table CLLI must be increased before additional entries can be made to this table.

**CAMACSW** (continued)**Datafill**

The following table lists datafill for table CAMACSW.

**Field descriptions**

Field	Subfield or refinement	Entry	Explanation and action
POSOCCUP		0 to 128	<i>CAMA positions occupied</i> Enter the number of centralized automatic message accounting (CAMA) positions occupied for thresholds.
GREEN		1 to 255	<i>Green lamp call waiting threshold</i> Enter number of calls waiting before the green lamp is illuminated.  Entries outside this range are invalid.
WHITE		1 to 255	<i>White lamp call waiting threshold</i> Enter the number of calls waiting before the white lamp is illuminated. This value must be greater than the value in field GREEN.  Entries outside this range are invalid.
RED		1 to 255	<i>Red lamp call waiting threshold</i> Enter the number of calls waiting before the red lamp is illuminated. This value must be greater than the value in field WHITE.  Entries outside this range are invalid.
DEFLECT		1 to 255	<i>Maximum in queue</i> Enter the number of calls waiting in the queue with audible ringing before subsequent calls are routed to CAMA queue overflow treatment. This value must be equal to or greater than the value in field RED.  Entries outside this range are invalid.

**Datafill example**

The following example shows sample datafill for table CAMACSW.



**CAMACSW** (end)

---

**MAP display example for table CAMACSW**

POSSOCCUP	GREEN	WHITE	RED	DEFLECT
0	1	2	3	4

**CAMACSW****Table name**

CAMA Call Waiting and Suspension Circuit Table

**Functional description**

Table CAMACSW stores the location of card NT2X66AA. The maximum number of circuits is one.

Table CAMACSW is represented in table CLLI by a fixed pseudo code CAPOX.

For related information, refer to table CAMACSW.

**Datafill sequence and implications**

There is no requirement to datafill other tables prior to table CAMACSW.

**Datafill**

The following table lists datafill for table CAMACSW.

**Field descriptions**

Field	Subfield or refinement	Entry	Explanation and action
CLLI		CAPOX	<i>Common language location identifier</i> Enter the code (CAPOX) assigned to the centralized automatic message accounting (CAMA) call waiting and suspension circuit.
TMTYPE		alphanumeric (3 characters)	<i>Trunk module type</i> Enter the acronym (TM8, for example) for the trunk module type on which the trunk card is located.
TMNO		0 to 2047	<i>Trunk module numbers</i> Enter the trunk module number on which the trunk card is located.
TMCKTNO		0 to 29 (even numbers only)	<i>Trunk module circuit number</i> Enter the trunk module circuit number of the CAMA call waiting and suspension circuit.
SIGOPT		EM or LP	<i>Signaling option</i> Identifies the signaling option associated with the NT2X66AA circuit, enter EM or LP (Loop).

## CAMACSWs (end)

---

### Datafill example

The following example shows sample datafill for table CAMACSWs.

The circuit is located on TM8 3 2 and the positions are arranged for loop signaling.

The table editor CHANGE command is not permitted on this table. The user must delete, then add. This ensures that the user is aware of the result if the new datafill is not accepted by the table editor.

### MAP display example for table CAMACSWs

CLLI	TMTYPE	TMNO	TMCKTNO	SIGOPT
CAPOX	TM8	3	2	LP

---

**CAPS**

---

**Table name**

Call Appearance Sequence

**Functional description**

The CAPS table is a dump-restore-only table. It is restored after table MDNGRP during a software upgrade. The dump and restore of table MDNGRP writes the call appearance (CA) tuples in the protected data structures in their default (sequential on CA number) search order. The dump and restore of table CAPS reorders them into the datafill order that was provisioned on the dump side (if any) through the SERVORD CAPSORD command.

Any existing CACH data on the dump side remains valid on the restore side after the CACH feature SOC has been set to off.

The CAPS table can only be modified by the CAPSORD command. Default values (0 0) for the CAPS table are created when SERVORD NEW or ADO commands are used to create the CAs of a CACH DN. Table CAPS specifies the sequence of call appearances in which calls to the directory number or call type (DN/CT) are directed. The first field in each compound value represents the number in the sequence. The second value is the call appearance number. A value in the first field cannot be repeated in a particular sequence list. Value zero, which represents an unassigned CA, can be repeated in field 2. The value ( 0 0 ) indicates that no CAPS order is defined for the DN.

**Datafill sequence and implications**

Table MDNGRP must be datafilled before table CAPS.

**Table size**

The CAPS table does not allocate store. There is one CAPS tuple for each CACH DN (not each CACH CA) datafilled in the office.

## CAPS (end)

---

### Datafill

The following table lists datafill for table CAPS.

#### Field descriptions

Field	Subfield or refinement	Entry	Explanation and action
DNKEY		10 digits	Directory number key
CADATA		0-16 and 0-16	Call appearance dataEnter the sequence order number for each call appearance and the sequence order number.

### Datafill example

The following example shows sample datafill for table CAPS.

#### MAP display example for table CAPS

DNKEY	CADATA
919 867 5309	(1 3) (2 2) (3 1) (4 5) (5 4) \$
919 867 5310	(0 0)

### Table history

#### NA008

Table CAPS introduced.

### Supplementary information

None

**CARDBRND****Table name**

Card Brand Table

**Functional description**

Table CARDBRND associates a name (card brand) with a given digit string. The card brand is associated with certain leading digits via datafill in table INTCCFMT, field SYMBOL. The CARDBRND is then used in Operational Measurement (OM) group TOPSINCC, where registers are pegged on a card brand basis.

**Datafill sequence and implications**

Each card brand (CARDBRND) must be datafilled here before it can be used in table INTCCFMT.

**Table size**

Table CARDBRND is a small, fixed-size table with 1 to 63 tuples.

Tuple 0 is the default and cannot be deleted or changed.

**Datafill**

The following table lists datafill for table CARDBRND.

**Datafilling table CARDBRND**

Field	Subfield or refinement	Entry	Explanation and action
VALUE		0-62	Value. An arbitrarily assigned number with the restrictions that no two card brands can be associated with the same VALUE number and no two VALUE numbers can be associated with the same (CARDBRND) card brand.
CARDBRND			Card brand. A 32-character string name definition of the card issuer for use in table INTCCFMT. The CARDBRND must be defined in this table before it can be used in table INTCCFMT, field CARDBRND.

**Datafill example**

The following example shows sample datafill for table CARDBRND.

## CARDBRND (end)

---

### MAP display example for table CARDBRND

VALUE	CARDBRND
0	defaultname
1	CCC1
2	CCC2
3	CCITT1

Tuple 0 is the default and cannot be changed.

### Table history

#### TOPS03

Table introduced by feature AN0409 in TOPS Commercial Credit Card, ABS00008.

---

## CARRMTC

---

### Table name

Carrier Maintenance

### Functional description

Table carrier maintenance (CARRMTC) allows the DMS switch administration to datafill maintenance control information in peripheral modules (PM), out-of-service limits for alarms, and system return-to-service occurrences.

Carrier by definition maintains communication on links connecting DMS PMs to channel banks, DMS PMs to remote DMS PMs, remote-to-remote DMS PMs, or DMS PMs to generic access nodes (AN).

Three carrier standards are served by the DMS family of switches; the 24-channel (DS-1) carriers are used for North American switches and the 30-channel (PCM30) carriers are used for international switches.

A third type of carrier, DS-0, (digital signal level 0) card type NT6X55AB (DS-0 interface card) is used in North America with digital trunk controllers (DTC). The DS-0 carrier provides a service switching point (SSP) office with the capability of CCS7 link access to a signaling transfer point (STP) node. The DS-0 interface can also respond to network-initiated maintenance actions, such as loopbacks.

For maintenance purposes, a DS-0 link acts as a DS-1 trunk except that it:

- only contains a single trunk
- supports 64- and 56-kbit/s data rates
- responds to remote loopback requests from the network
- does not transmit or detect remote carrier group alarm (RCGA) and alarm indication signal (AIS)

Table CARRMTC contains PM maintenance data, out-of-service limits for alarms and system return-to-service information. Up to 16 entries are present for each type of PM that is capable of providing carrier links in the switch (one entry for each PM type is allotted as a default entry).

The VOICELAW field used for setting mu-law or A-law for a carrier in table CARRMTC is used to generate the User Service Information (USI) parameter



## CARRMTC (continued)

---

in Initial Address Messages (IAMs) to mu-law or A-law values. Take care when setting this parameter and ensure the following:

- For tuples in table CARRMTC (Carrier Maintenance Control) associated with NCCI#7 trunks on the North American network. These tuples must have the VOICELAW field set to MU\_LAW.
- For tuples in table CARRMTC associated with ANSI7+ trunks on the international network. The VOICELAW field in this tuple must contain A\_LAW. The NATLBIT field must contain INTERNATL.

### Table datafill element descriptions

The following section contains general descriptions of alarms, alarm states, signals, and other elements essential to the understanding the datafill descriptions in table CARRMTC.

#### Alarm descriptions: 24-channel DS-1

Carrier alarms are characterized by steady-state and hit-state properties:

- An alarm reaches its steady state if the switch records a continuous occurrence of signals that do not meet the appropriate specification (for example, local carrier group alarm (LCGA) or remote carrier group alarm [RCGA]).
- An alarm reaches its hit state if the switch records isolated or intermittent occurrence of signals that do not meet the appropriate specification (for example, frame loss and slip alarms).

When frame loss reaches its steady-state, it becomes a local carrier group alarm (LCGA). The maintenance and out-of-service limits for frame loss and slip are datafilled in table OFCENG and table CARRMTC fields FRAMEML, FRAMEOL, SLIPML, and SLIPOL.

*Note:* Table OFCENG records these limits as well.

A carrier link can be put out of service by the system when an alarm is raised, and returned to service when the alarm is dropped. If the alarms occur frequently, the carrier state can bounce between system busy and in service.

In a return to service (RTS) system, a counter controls the number of system returns. The counter keeps track of the number of times the carrier is returned to service within the audit interval. The counter increments when the carrier is returned to service by the system and is reset in the next audit.

If the counter value exceeds the maintenance limit (field RTSML) in table CARRMTC, a warning appears on the MAP terminal. If the counter value exceeds the out-of-service limit (field RTSOL), a criterion for putting the

---

**CARRMTC** (continued)

---

carrier permanently out of service is reached. Once a carrier is permanently out of service, it remains in this state until it is manually returned to service.

For more information on alarm descriptions for DS-1 trunks, refer to the *Trunks Maintenance Guide*, 297-1001-595.

**Alarm descriptions: 30-channel PCM30****Steady-state alarm**

This is an error detected and timed in the PM that persists for a duration equal to the out-of-service time limit (field OST) datafilled in table CARRMTC. A PM report is sent to central control. The report states that a steady-state (SS) alarm is raised.

**Hit-state warning — maintenance limit**

This warning is defined as a detected error that does not persist for a duration of OST. That is, the error is interrupted by correct signals during the out-of-service time. Under these circumstances, one or more hits are encountered. If the number of hits, accumulated over a 1-min interval, exceeds the maintenance limit (ML) datafilled in table CARRMTC, a peripheral module report is sent to central control. The report states that a hit state warning is raised.

**Hit-state alarm — out-of-service**

This alarm is similar to hit state warning ML except that the number of hits is accumulated over a 5-min interval. If the accumulated number of hits exceeds the out-of-service limit (OL) datafilled in table CARRMTC, a hit-state alarm is raised.

The hit alarm is also subject to the SETACTION boolean field in table LTCPSINV. If SETACTION is false, the carrier state is not changed to system-busy even if the out-of-service limit is exceeded.

**Criteria for dropping alarms****Steady-state alarm**

A peripheral module serving 30-channel carriers detects when a carrier with steady-state alarm reverts to its correct signal sequence. The duration of this correct signal reaches the return-to-service time (RST) datafilled in table CARRMTC. Under these circumstances, a peripheral module report is sent to central control. The report states that the steady-state alarm is dropped.

**Hit-state warning — maintenance limit**

Having detected a hit-state warning, the PM resets the appropriate hit counter. If the number of hits, accumulated over the next 1-min interval, is less than the maintenance limit in table CARRMTC, a PM report is sent to central control. The report states that the hit state warning is dropped.

## **CARRMTC** (continued)

---

### **Hit state alarm — out-of-service**

Having detected a hit state alarm, the PM resets the appropriate hit counter. If the number of hits, accumulated over the next 5-min interval, is less than the out-of-service limit in table CARRMTC, a PM report is sent to central control. The report states that the hit-state alarm is dropped.

### **Definition of errors**

For information on the definition of errors, refer to the *Trunks Maintenance Guide*, 297-1001-595.

### **M20 alarm types**

M20 is a Japanese frame structure used to package digital voice and data in a format suitable for telecommunication. The framing is similar to CCITT PCM30 frame structure.

The frame structure of the 2048 kbit/s uses modified dipulse (MD) code. This is a coded mark inversion (CMI) with a code violation to mark the beginning of each frame. There are 8 bits per time slot (bits 1 to 8), 32 time slots per frame (slots 0 to 31) and 256 bits per frame. A multiframe consists of eight consecutive frames (frames 1 to 8). Multiframe length is 1 ms.

A handling group (HG) is composed of 6 of the 30 voice or data channels on a given digital carrier. Each carrier consists of the five handling groups. Signaling for each handling group is contained in time slot 0, bits 4 to 8. Multiframe alignment is independent for each handling group and is defined by an F-bit that alternates once every eight frames. For each HG, a multiframe consists of an F-bit, six sequential signaling bits, and an alarm bit (SP indicating TNR2 alarm).

### **Frame alignment**

This alarm is caused by a loss of the incoming 2048-kbit/s signal or loss of incoming frame alignment. The alarm is detected by the M20 interface if it finds a missing code violation bit or two code violation bits, or two code violation bits that are not separated by 125  $\mu$ s. This alarm operates on the whole frame and is the equivalent of local loss of frame alignment (LLFA) for PCM30 links.

### **Alarm**

This alarm is received by the M20 interface and indicates that the equipment generating the alarm cannot receive the incoming 2048-kbit/s signal. The alarm is detected when a binary 1 is detected in bit 2 of time slot 0. This alarm operates on the whole frame and is the equivalent of remote frame alarm indication (RFAI) in PCM30 links.

---

**CARRMTC** (continued)

---

**TNR1**

This alarm is caused by a loss of proper sequence of framing bits in a handling group, or all bits in a handling group set to 1 (if not equivalent to local loss of multiframe alignment (LLMA) in PCM30 links).

**TNR2**

This alarm is detected using the SP alarm bits on the handling group bit streams. It means that the distant M20 multiplexer cannot receive signaling information on the handling group from the local M20 multiplexor. TNR2 is the handling group equivalent of remote multiframe alarm indication (RMAI) for PCM30 links.

**Alarm indication signal (AIS)**

This alarm occurs when a stream of all ones (1) is detected on the incoming signaling link. It is the same as AIS for PCM30 links and is generated by the M20 interface when a link is manually busied.

**Slip**

This error occurs when a frame of data is repeated or slipped over. It is the same as slip in PCM30 links.

**TTC alarm types**

The TTC interface standard is a Japanese frame structure used to package digital voice and data in a format suitable for telecommunication. The TTC standard is similar to CCITT PCM30 and Japanese M20 standards. The main differences lie in the signaling bits.

A frame in TTC is thirty-two 8-bit time slots, the control and signaling information is in time slot 0, time slot 16 is not used, and code mark inversion marks the beginning of frames. Unlike M20 frames, the signaling for the voice and data channels is not split up into handling groups, and multiframing is instead provided over all of the signaling bits. A frame is 125  $\mu$ s in duration, and a multiframe is 8 frames.

**Frame alignment (FA)**

This alarm is caused by a loss of the incoming 2048-kbit/s signal or loss of incoming frame alignment. It is detected by the TTC interface if it finds two consecutive missing code violation bits, or two code violation bits that are not separated by 125  $\mu$ s. This alarm operates on the whole frame and is the equivalent of local loss of frame alignment (LLFA) for PCM30 links, and FA for M20 links.

**S-bit alarm indication**

This alarm is received by the TTC interface and indicates that the equipment generating the alarm cannot receive the incoming 2048-kbit/s signal. The

## **CARRMTC** (continued)

---

alarm occurs when a binary 1 is detected in bit 2 of time slot 0. It operates on the whole frame and is the equivalent of remote frame alarm indication (RFAI) in PCM30 links and AL in M20 links.

### **Multiframe alignment (MA)**

This alarm indicates a local loss of multiframe alignment. It is raised when the correct multiframe pattern in bit 1 of time slot 0 is broken. This alarm is similar to local loss of multiframe alignment (LLMA) in PCM30 links.

This alarm occurs when a stream of all ones (1) is detected on the incoming signaling link. It is the same as AIS for PCM30 and M20 links and is generated by the TTC interface when a link is manually busied.

### **Slip**

This error occurs when a frame of data is repeated or slipped over. It is the same as slip in PCM30 and M20 links. No steady-state alarm is applicable for slip.

### **Alarm attributes**

The alarm attributes for ISDN digital trunk controllers (DTCI) and PCM30 digital trunk controllers (PDTC) consists of OST, RST, ML, and OL as described below.

OST is the out-of-service time in units of 0.1 s. This is the time for which an erroneous carrier signal must persist before the carrier is put out of service. OST is downloaded into the PM and the timing is made by the PM.

RST is the return-to-service time in units of 0.1 s. This is the time for which a correct carrier signal must persist before the carrier is put back to service. RST is downloaded into the PM and the timing is made by the PM.

ML is the maintenance limit. It is the number of nonpersistent errors that can be accumulated by the PM within a 1-min interval (except slip) before a hit-state warning is raised.

OL is the out-of-service limit. It is the number of nonpersistent errors that can be accumulated by the PM within a 5-min interval (except slip) before a hit-state warning is raised.

### **Datafill sequence and implications**

The following tables must be datafilled after table CARRMTC:

- RCCPSINV
- appropriate C-side inventory table

---

**CARRMTC** (continued)

---

The choice of entries for each carrier is datafilled in the inventory table of the C-side PM (for example, tables DCMINV and LTCINV) and the following verifications are made between table CARRMTC and the inventory tables:

- If a carrier index (CARRIDX) is datafilled in an inventory table (for example, table DCMINV), an entry of that PM type (for example, table DCM) must already exist in table CARRMTC. If not, the index is rejected by the data dictionary.
- If an entry is deleted from table CARRMTC, that entry must not be referenced by any carriers in the inventory tables. If any such reference exist, the deletion command is rejected.
- If an existing entry in table CARRMTC is changed, the associated PM inventory table is checked. If the entry is referenced by in-service carriers, the change command is rejected and the in-service carriers are listed.

A tuple in table CARRMTC must be datafilled before the extended multiprocessor system (XMS)-based peripheral modules (XPM) P-side inventory table RCCPSINV tuple is changed. Before a tuple in table CARRMTC is deleted or changed, no links in the XPMs P-side inventory table can be referenced in field TMPLTNM.

Before changing RCO2 P-side link data in table RCCPSINV from NILTYPE to D30, table CARRMTC must be datafilled.

A tuple in table CARRMTC must be datafilled before the XPMs P-side inventory table (LTCPSINV) tuple is changed.

The table CARRMTC default tuples are added by the system and they cannot be deleted. Only some of the data fields can be changed in the default tuples.

## Table size

1 to 16 tuples (number of XPMs in field CSPMTYPE)

The table sizing mechanism is unchanged. Data store for maximum tuples is allocated at compile time. On initial program load (IPL), one default tuple is datafilled in table CARRMTC for each PM type that exists in the office and in field CSPMTYPE. Other tuples are added manually for different maintenance thresholds.

If any other field is changed, a new tuple must be added to table CARRMTC. This new tuple is then used with the appropriate carriers.

**CARRMTC** (continued)

---

**Datafill**

The following table lists datafill for table CARRMTC.

**CARRMTC** (continued)**Field descriptions**

Field	Subfield or refinement	Entry	Explanation and action
CSPMTYPE		ARCC, DCM, DFI, DTC, DTCl, FRIU, GPP, HLIU, HSI2, IAC, IDTC, ILGC, ILTC, LGC, LGCI, LTC, LTCl, PDTC, PLGC, PLGC, UNIREM, PRCC, RCC, RCC2, RCO2, SMA, SMR, SMS, SMSR, SMU, SRCC, TMS, or NIL	<p data-bbox="855 457 1283 483"><i>C-side node peripheral module type</i></p> <p data-bbox="855 506 1385 562">Enter the PM type of the node on the C-side of the carrier link.</p> <ul data-bbox="855 585 1385 1329" style="list-style-type: none"> <li data-bbox="855 585 1385 642">• ARCC is for Austrian remote cluster controllers.</li> <li data-bbox="855 665 1385 690">• DCM is for digital carrier modules.</li> <li data-bbox="855 714 1385 739">• DFI is for direct fiber interface.</li> <li data-bbox="855 762 1385 787">• DTC is for digital trunk controllers.</li> <li data-bbox="855 810 1385 835">• DTCl is for ISDN DTCs.</li> <li data-bbox="855 858 1385 1024">• FRIU is for frame relay interface units.</li> <li data-bbox="855 1047 1385 1329">• GPP is for Global Peripheral Platform, which is a common peripheral module (CPM)-based host peripheral for generic access nodes (AN).</li> <li data-bbox="855 1050 1385 1329">• HLIU is for high-speed link interface unit, which provides CCS7 signaling terminations for a DS-1 CCS7 link, and processes the asynchronous transfer mode (ATM) signaling ATM adaptation layer (SAAL) and the CCS7 protocol stack up to CCS Layer 3 (and parts of signaling connection control part [SCCP]).</li> </ul>



**CARRMTC** (continued)**Field descriptions**

Field	Subfield or refinement	Entry	Explanation and action
CSPMTYPE (continued)			<p data-bbox="855 457 1283 533"><i>C-side node peripheral module type</i> (continued).</p> <ul data-bbox="855 554 1390 1787" style="list-style-type: none"> <li data-bbox="855 554 1283 585">• LGC is for line group controllers.</li> <li data-bbox="855 600 1187 632">• LGCI is for ISDN LGCs.</li> <li data-bbox="855 646 1275 678">• LTC is for line trunk controllers.</li> <li data-bbox="855 693 1382 852">• LTC+ is for line trunk controllers with peripheral life upgrade strategy (PLUS), an LTC equipped with an NTMX77 [unified processor] card, datafilled as LTC.</li> <li data-bbox="855 867 1177 898">• LTCl is for ISDN LTCs.</li> <li data-bbox="855 913 1321 982">• PDTC is for 30-channel pulse code modulation (PCM30) DTCs.</li> <li data-bbox="855 997 1222 1029">• PLGC is for PCM30 LGCs.</li> <li data-bbox="855 1043 1382 1171">• PLGC UNIREM is a remote LCD based peripheral, designed for the international market. D30 carrier type is used on the host P-side (PLGC).</li> <li data-bbox="855 1186 1321 1255">• PRCC is for PCM30 remote cluster controllers (RCC).</li> <li data-bbox="855 1270 1114 1302">• RCC is for RCCs.</li> <li data-bbox="855 1316 1382 1444">• RCC2 (remote cluster controller #2) sets carrier maintenance limits and alarms for carriers having an RCC2 XPM on their C-side.</li> <li data-bbox="855 1459 1382 1587">• RCO2 (remote switching center offshore #2) sets carrier maintenance limits and alarms for carriers having an RCO2 XPM on their C-side.</li> <li data-bbox="855 1602 1390 1787">• SMA (subscriber carrier module-100 access) is the LTC-based DMS PM that provides cell site controller (CSC) and embedded operations channel (EOC) link management, DS-1 facility management, and the interface to the DMS-core.</li> </ul>

**CARRMTC** (continued)**Field descriptions**

Field	Subfield or refinement	Entry	Explanation and action
CSPMTYPE (continued)			<p data-bbox="855 457 1283 533"><i>C-side node peripheral module type</i> (continued).</p> <ul data-bbox="855 554 1390 1583" style="list-style-type: none"> <li data-bbox="855 554 1390 709">• SMR (subscriber carrier module-100 rural) provides an interface between the remote concentrator terminal of a DMS-1 switch and the central office of a DMS-100 Family switch.</li> <li data-bbox="855 730 1390 886">• SMS (subscriber carrier module-100S) provides an interface between the remote concentrator SLC-96 (RCS) of an SLC-96 system and the central office of a DMS-100 Family switch.</li> <li data-bbox="855 907 1390 995">• SMSR (SMS remote) provides an interface between the RCS and a remote switching center (RSC).</li> <li data-bbox="855 1016 1390 1583">• SRCC (Synchronous Optical Network [SONET] remote cluster controller) is an remote cluster RCC hosted by the direct fiber interface with a SONET interface on its C-side. This RCC sets carrier maintenance limits and alarms for carriers having an SRCC XPM on their C-side. For SRCCs, one tuple is added to provide maintenance thresholds for SRCC carriers (as with RCC2 carriers). SRCC carrier tuples contain various carrier maintenance limits and information for DS-1 carriers that are remote or are trunks. Before changing SRCC P-side link data in table RCCPSINV from NILTYPE to DS1 &lt;string name&gt; or DS1 DEFAULT, table CARRMTC must be datafilled.</li> </ul>

**CARRMTC** (continued)**Field descriptions**

Field	Subfield or refinement	Entry	Explanation and action
CSPMTYPE (continued)			<p><i>C-side node peripheral module type</i> (continued).</p> <ul style="list-style-type: none"> <li>• SMU (subscriber carrier module-100 urban) provides an interface between the remote carrier urban (RCU) of a DMS-1 switch and the central office of a DMS-100 Family switch.</li> <li>• TMS (Traffic Operator Position System [TOPS] message switch) is based on the ISDN line trunk controller (LTCI). TMS eliminates the need for direct data links between TOPS position controllers (TPC) and database systems as well as providing a high speed link for CC_TPC communication. TMS acts as a host to the TPC and provides switched access to external databases such as directory assistance (DA) and operator reference database (ORDB). Service nodes that can subtend the TMS are DA and ORDB.</li> </ul> <p>TMS interfaces to DA and ORDB through DS-1 links. TMS interfaces to the TPC through DS-1 links and channel banks. Each DS-1 link can support up to four TPCs. There are 24 channels for each DS-1 link. Each TPC utilizes four voice channels and up to two data channels. Each DS-1 link can accommodate up to four TPCs.</p> <ul style="list-style-type: none"> <li>• Enter NIL if there is no signaling type.</li> </ul>
TMPLTNM		alphanumeric (1 to 16 characters)	<p><i>Template name</i></p> <p>Enter the template name for the PM. This entry also appears in the inventory tables, field CARRIDX.</p> <p>The default value is DEFAULT.</p> <p><b>Note:</b> For Gateways, the value is GWIP.</p>

**CARRMTC** (continued)**Field descriptions**

<b>Field</b>	<b>Subfield or refinement</b>	<b>Entry</b>	<b>Explanation and action</b>
RTSML		numeric (0 to 255)	<p><i>Return-to-service maintenance limit</i></p> <p>Enter the number of times within the audit interval that a carrier can be returned to service (RTS) by the system before a warning is issued.</p> <p>An entry of 255 disables this feature.</p> <p><b>Note:</b> Gateways use the value 255.</p>
RTSOL		numeric (0 to 255)	<p><i>Return-to-service out-of-service limit</i></p> <p>Enter the number of times within the audit interval that a carrier can be returned to service by the system before it is put permanently out of service.</p> <p>An entry of 255 disables this feature.</p> <p><b>Note:</b> Gateways use the value 255.</p>
ATTR		see subfield	<p><i>Attribute</i></p> <p>This field consists of subfield SELECTOR and refinements.</p>

**CARRMTC** (continued)**Field descriptions**

Field	Subfield or refinement	Entry	Explanation and action
	SELECTOR	DS1 D30 FRT1 M20 NDS0 SONET TTC or NIL	<p><i>Selector</i></p> <p>Enter DS1 if the entry for field CSPMTYPE is DCM, DTC, HLIU, IAC, LTC, RCC, RCC2, SMR, SMS, SMSR, SMU, LGCI, LTCL, DTCL, TTC, LTC, LGC, or TMS. For selector value DS-1 refinement datafill information, refer to section "SELECTOR = DS1".</p> <p>Enter D30 if the entry for field CSPMTYPE is GPP, IDTC, ILGC, ILTC, PDTC, PLGC, RCO2, or TMS. For selector value D30 refinement datafill information, refer to sectionn " SELECTOR = D30".</p> <p>Enter FRT1 for frame relay T1 usage. For selector value FRT1 refinement datafill information, refer to section "SELECTOR = FRT1".</p> <p>Enter M20 for the Japanese market if the entry for field CSPMTYPE is PDTC only. For selector value M20 refinement datafill information, refer to section "SELECTOR = M20".</p>

**CARRMTC** (continued)**Field descriptions**

Field	Subfield or refinement	Entry	Explanation and action
	SELECTOR (continued)		<p>Enter NDS0 as the selector for PCM30 digital trunk controller (PDTC) only. For selector value NDS0 refinement datafill information, refer to section "SELECTOR = NDS0".</p> <p>Enter SONET for the Synchronous Optical Network. For selector value SONET refinement datafill information, refer to section "SELECTOR = SONET".</p> <p>Enter TTC for the Japanese market if the entry for field CSPMTYPE is PDTC only. For selector value TTC refinement datafill information, refer to section "SELECTOR = TTC".</p> <p>Enter NIL if no selector is required.</p> <p>The NT6X27JB card (TTC interface) provides the interface between the PDTC and external telecommunication technical committee (TTC) interface standard pulse code modulation (PCM) equipment. Each interface card contains two TTC ports. Each PDTC can have up to 8 interface cards, making a total of 16 P-side ports. This total is composed of either eight TTC cards or any combination of PCM30, M20, and TTC interface cards.</p> <p>Correct operation of all diagnostics concerned with the TTC card requires the presence of the following cards:</p> <ul style="list-style-type: none"> <li>• NT6X44EA (universal time switch card)</li> <li>• NT6X28AA/AB (signaling interface card)</li> <li>• NT6X69LA (message protocol and downloadable tones)</li> <li>• NT6X27JB (TTC interface card)</li> </ul>

**CARRMTC** (continued)

---

**SELECTOR = DS1**

If the entry in field SELECTOR is DS1, datafill refinement CARD as described below.

**CARRMTC** (continued)**Field descriptions**

<b>Field</b>	<b>Subfield for refinement</b>	<b>Entry</b>	<b>Explanation and action</b>
	CARD	NT2X35AB NT6X50AA NT6X50AB NT6X55AB NT6X55BA NT6X55JA NT6X85AA NT6X85AB NTEX78AA or NTMX81AA	<p><i>Product engineering code of card</i></p> <p>Enter the product engineering code (PEC) of the card used.</p> <p>The NT2X35AB card (DCM interface) is used in digital carrier modules (DCM). If this value is entered, refinements FRAMEML, FRAMEOL, SLIPML, and SLIPOL must be datafilled as described in section "CARD = NT2X35AB".</p> <p>The NT6X50AA card (DS-1 interface) is used in DS-1 service with A/B signaling. The NT6X50AB card (DS-1 EFF) is used in DS1 service with EFF and A/B/C/D bit signaling. If either of these values is entered, additional refinements must be datafilled in accordance with the description in section "CARD = NT6X50AA, NT6X50AB, NT6X85AA, NT6X85AB, or NTMX81AA".</p> <p>The NT6X55AB card (DS-0 interface) is a DS-0A carrier used in DS-0 link types for digital trunk controllers (DTC), and is applicable for BCS33 and subsequent loads. If this value is entered, additional refinements must be datafilled in accordance with the description in section "CARD = NT6X55AB, NT6X55BA, or NT6X55JA".</p>



**CARRMTC** (continued)**Field descriptions**

Field	Subfield for refinement	Entry	Explanation and action
	CARD (continued)		<p>The refinements for NT6X55BA card (64-bit access) are identical to the existing NT6X55AB card except that the only allowed data rate is 64 kbit/s. The NT6X55BA card allows the PCM type DS-1 datafill on PDTC peripheral modules. This card also allows a DS-0 card on PDTC peripheral modules. If this value is entered, additional refinements must be datafilled in accordance with the description in section "CARD = NT6X55AB, or NT6X55JA".</p> <p>The NT6X55JA card (digital trunk controller CII/CMI [Japan]) is for carrier DS-0 and has limited fields. If this value is entered, additional refinements must be datafilled in accordance with the description in section "CARD = NT6X55AB, NT6X55BA, or NT6X55JA".</p> <p>The NT6X85AA card is the DS-1 interface for the SLC-96 card. The NT6X85AB card provides similar functionality to the NT6X85AA, but supports special features and two DS-1 circuits. If either of these values is entered, additional refinements must be datafilled in accordance with the description in section "CARD = NT6X50AA, NT6X50AB, NT6X85AA, NT6X85AB, or NTMX81AA".</p> <p>The NTEX78AA card is a DS-1 paddle board, which supports the HLIU. If this value is entered, additional refinements must be datafilled in accordance with the description in section "CARD = NTEX78AA".</p> <p>The NTMX81AA card (dual DS-1 interface) is a refinement added in BCS33 for dual DS-1 packets for common PM (CPM) carrier tuples. If this value is entered, additional refinements must be datafilled in accordance with the description in section "CARD = NT6X50AA, NT6X85AA, NT6X85AB, or NTMX81AA".</p>

**CARRMTC** (continued)**CARD = NT2X35AB**

If the entry in field CARD is NT2X35AB, datafill refinements FRAMEML, FRAMEOL, SLIPML, and SLIPOL as described below.

**Field descriptions for conditional datafill**

Field	Subfield or refinement	Entry	Explanation and action
	FRAMEML	numeric (0 to 9999)	<i>Frame maintenance limit</i> Enter the maintenance limit for frame loss. The default value is 17.
	FRAMEOL	numeric (0 to 9999)	<i>Frame loss limit</i> Enter the out-of-service limit for frame loss. The default value is 511.  <b>Note:</b> The value of field FRAMEOL must be greater than the value of field FRAMEML. Otherwise, only field FRAMEOL is used.
	SLIPML	numeric (0 to 9999)	<i>Slip maintenance limit</i> Enter the maintenance limit for slip. The default value is 4.
	SLIPOL	numeric (0 to 9999)	<i>Slip out-of-service limit</i> Enter the out-of-service limit for slip. The default value is 255.  <b>Note:</b> The value of field SLIPOL must be greater than the value of field SLIPML. Otherwise, only field SLIPOL is used.

**CARRMTC** (continued)**CARD = NT6X50AA, NT6X50AB, NT6X85AA, NT6X85AB, or NTMX81AA**

If the entry in field CARD is NT6X50AA, NT6X50AB, NT6X85AA, NT6X85AB, or NTMX81AA, datafill the refinements described below.

**Field descriptions for conditional datafill**

Field	Subfield or refinement	Entry	Explanation and action
	VOICELAW	MU_LAW or A_LAW	<i>Voice law</i>  Enter the voice law used in the carrier. A_LAW is mainly used in international switches and MU_LAW is mainly used in North American switches.
	FF	SF or ESF	<i>Frame format</i>  Enter SF for standard format. Enter ESF for extended superframe format.  <b>Note:</b> Only the NT6X50AA/AB card supports extended superframe format (ESF).
	ZLG	ZCS or B8ZS	<i>Zero logic</i>  Enter ZCS for zero code suppression. Enter B8ZS for bipolar 8-bit zero substitution.  <b>Note 1:</b> Enter B8ZS when the high data link controller (HDLC) messaging protocol supported is link access protocol on the D-channel (LAPD).  <b>Note 2:</b> Only the NT6X50AA/AB card supports bipolar 8-bit zero substitution (B8ZS).
	BERB	BPV or CRC	<i>Bit error rate base</i>  Enter BPV for bipolar violation. Enter CRC for cyclic redundancy check.
	DLK	NILDL, FDL1, or FDL2	<i>Data link</i>  Enter NILDL for nil data link. Enter FDL1 for facility data line input from time slot 2. Enter FDL2 for facility data link input from external interrupt.  <b>Note:</b> Currently, only NILDL is supported.

**CARRMTC** (continued)**Field descriptions for conditional datafill**

<b>Field</b>	<b>Subfield or refinement</b>	<b>Entry</b>	<b>Explanation and action</b>
	IAT	Y or N	<p><i>Inhibit alarm transmit</i></p> <p>Enter Y (yes) if alarm transmit is inhibited; otherwise, enter N (no). For all links on RCS modules, including protection links, enter Y, since yellow alarms are unsupported.</p> <p>Datafill links in an SMU-RCU subsystem as Y, since the RCU cannot recognize a yellow alarm.</p>
	LCGAST	numeric (1 to 9999)	<p><i>Local carrier group alarm set threshold</i></p> <p>Enter a value for the threshold in units of 10 ms.</p> <p>Primary links on an SMS have a range of 40 to 250 ms. It is recommended that 80 be datafilled if protection links are present and 250 be datafilled if they are absent. The range for protection links is 100 to 250 ms. It is recommended that 250 be datafilled. The recommended datafill for primary links off an SMU is 2500.</p>
	LCGACL	numeric (1 to 9999)	<p><i>Local carrier group alarm clear threshold</i></p> <p>Enter a value for the threshold in units of 10 ms.</p> <p>Primary links on an SMS have a range of 100 to 1000 ms. It is recommended that 200 be datafilled if protection links are present and 1000 be datafilled if they are absent. The range for protection links is 200 to 400 ms. It is recommended that 300 be datafilled. The recommended datafill for links off an SMU is 9999.</p>
	RCGAST	numeric (1 to 9999)	<p><i>Remote carrier group alarm set threshold</i></p> <p>Enter a value for the threshold in units of 10 ms.</p> <p>RCU modules use a time of 220 ms that overrides any value datafilled.</p>

**CARRMTC** (continued)**Field descriptions for conditional datafill**

<b>Field</b>	<b>Subfield or refinement</b>	<b>Entry</b>	<b>Explanation and action</b>
	RCGACL	numeric (1 to 9999)	<i>Remote carrier group alarm clear threshold</i> Enter a value for the threshold in units of 10 ms. RCU modules use a time of 5 s that overrides any value datafilled.
	AISST	numeric (1 to 9999)	<i>Alarm indication signal set threshold</i> Enter a value for the threshold in units of 10 ms.
	AISCL	numeric (1 to 9999)	<i>Alarm indication signal clear threshold</i> Enter a value for the threshold in 10 ms.
	BEROL	numeric (3 to 6)	<i>Bit error rate out-of-service limit</i> Enter the bit error rate out-of-service limit expressed as the negative of the exponent of 10, for example an entry of 4 corresponds to a bit error rate of 10 <sup>-4</sup> .
	BERML	numeric (4 to 7)	<i>Bit error rate maintenance limit</i> Enter the bit error rate maintenance limit expressed as the negative of the exponent of 10 (10 <sup>-n</sup> ).
	ES	numeric (0 to 9999)	<i>Error second threshold</i> Enter a value for the threshold in units of 10 ms.
	SES	numeric (0 to 9999)	<i>Severe error second threshold</i> Enter a value for the threshold in units of 10 ms.
	FRAMEML	numeric (0 to 9999)	<i>Frame maintenance limit</i> Enter the maintenance limit for frame loss.

**CARRMTC** (continued)**Field descriptions for conditional datafill**

Field	Subfield or refinement	Entry	Explanation and action
	FRAMEOL	numeric (0 to 9999)	<i>Frame loss limit</i> Enter the out-of-service limit for frame loss.  <b>Note:</b> The value of field FRAMEOL must be greater than the value of field FRAMEML. Otherwise, only field FRAMEOL is used.
	SLIPML	numeric (0 to 9999)	<i>Slip maintenance limit</i> Enter the maintenance limit for slip.
	SLIPOL	numeric (0 to 9999)	<i>Slip out-of-service limit</i> Enter the out-of-service limit for slip.  <b>Note:</b> The value of field SLIPOL must be greater than the value of field SLIPML. Otherwise, only field SLIPOL is used.

**CARD = NT6X55AB, NT6X55BA, or NT6X55JA**

If the entry in field CARD is NT6X55AB, NT6X55BA, or NT6X55JA, datafill the refinements described below.

**Field descriptions for conditional datafill**

Field	Subfield or refinement	Entry	Explanation and action
	RATE	48K, 56K, or 64K	<i>Data rate</i> Enter the data rate used: 48 kbit/s, 56 kbit/s, or 64 kbit/s.  <b>Note:</b> Use 56K or 64K with card NT6X55AB. Use 64K only with card NT6X55BA. Use 48K or 64K with card NT6X55JA.
	CLOCK	EXTRNL or INTRNL	<i>Clock</i> Enter the source of the clock: INTRNL for internal, EXTRNL for external.

**CARRMTC** (continued)**Field descriptions for conditional datafill**

<b>Field</b>	<b>Subfield or refinement</b>	<b>Entry</b>	<b>Explanation and action</b>
	LSC	NEI or LINE	<p><i>Loopback select code</i></p> <p>Enter LINE for the loopback select code used if the loopback is applied at the line side. Enter NEI if loopback is applied at the network element interface.</p> <p><b>Note:</b> Field LSC is not used with card NT6X55JA.</p>
	IAT	Y or N	<p><i>Inhibit alarm transmit</i></p> <p>Enter Y (yes) if the alarm transmit is inhibited; otherwise, enter N (no).</p>
	LCGAST	numeric (1 to 9999)	<p><i>Local carrier group alarm set threshold</i></p> <p>Enter a value for the threshold in units of 10 ms.</p>
	LCGACL	numeric (1 to 9999)	<p><i>Local carrier group alarm clear threshold</i></p> <p>Enter a value for the threshold in units of 10 ms.</p>
	BEROL	numeric (3 to 6)	<p><i>Bit error rate out-of-service limit</i></p> <p>Enter the bit error rate out-of-service limit expressed as the negative exponent of 10, for example an entry of 3 corresponds to a bit error rate of <math>10^{-3}</math>.</p>
	BERML	numeric (4 to 7)	<p><i>Bit error rate maintenance limit</i></p> <p>Enter the bit error rate maintenance limit expressed as the negative exponent of 10 (<math>10^{-n}</math>).</p>
	ES	numeric (0 to 9999)	<p><i>Error second threshold</i></p> <p>Enter a value for the threshold in units of 10 ms.</p>
	SES	numeric (0 to 9999)	<p><i>Severe error second threshold</i></p> <p>Enter a value for the threshold in units of 10 ms.</p>

**CARRMTC** (continued)**Field descriptions for conditional datafill**

Field	Subfield or refinement	Entry	Explanation and action
	SLIPML	numeric (0 to 9999)	<i>Slip maintenance limit</i> Enter the maintenance limit for slip. This value is expressed in terms of the number of slips that are accumulated by the PM within a 24-h or 1-min interval before a hit-state alarm for slip is raised.
	SLIPOL	numeric (0 to 9999)	<i>Slip out-of-service limit</i> Enter the out-of-service limit for slip. This value is expressed in terms of the number of slips that are accumulated by the PM within a 24-h or 1-min interval before a hit-state alarm for slip is raised.  <b>Note:</b> The value of field SLIPOL must be greater than the value of field SLIPML. Otherwise, only field SLIPOL is used.
	CIICMI	CII or CMI	<i>CII and CMI selector</i> If the entry in field CARD is NT6X55JA, datafill this refinement. Enter either CII or CMI.

**CARD = NTEX78AA**

If the entry in field CARD is NTEX78AA, datafill the refinements described below.

**Field descriptions for conditional datafill**

Field	Subfield or refinement	Entry	Explanation and action
	FF	ESF	<i>Frame format</i> Enter ESF for extended superframe format.
	LCGAST	numeric (1 to 9999)	<i>Local carrier group alarm set threshold</i> Enter a value for the threshold in units of 10 ms.  The default value is 250 (2.5 s).



**CARRMTC** (continued)**Field descriptions for conditional datafill**

<b>Field</b>	<b>Subfield or refinement</b>	<b>Entry</b>	<b>Explanation and action</b>
	LCGACL	numeric (1 to 9999)	<i>Local carrier group alarm clear threshold</i> Enter a value for the threshold in units of 10 ms. The default value is 2000 (20 s).
	RCGAST	numeric (0 to 9999)	<i>Remote carrier group alarm set threshold</i> Enter a value for the threshold in units of 10 ms. The default value is 0 (0 s).
	RCGACL	numeric (0 to 9999)	<i>Remote carrier group alarm clear threshold</i> Enter a value for the threshold in units of 10 ms. The default value is 0 (0 s).
	AISST	numeric (1 to 9999)	<i>Alarm indication signal set threshold</i> Enter a value for the threshold in units of 10 ms. The default value is 250 (2.5 s).
	AISCL	numeric (1 to 9999)	<i>Alarm indication signal clear threshold</i> Enter a value for the threshold in 10 ms. The default value is 2000 (20 s).
	LCDST	numeric (1 to 9999)	<i>Loss of cell delineation alarm set threshold</i> Enter the limit in units of 10 ms. The default value is 250 (2.5 s).
	LCDCL	numeric (1 to 9999)	<i>Loss of cell delineation alarm clear threshold</i> Enter the limit in units of 10 ms. The default value is 1 000 (10 s).
	ESPDML	numeric (0 to 9999)	<i>Errored seconds-path daily report threshold</i> Enter the limit. The default value is 648.

**CARRMTC** (continued)**Field descriptions for conditional datafill**

<b>Field</b>	<b>Subfield or refinement</b>	<b>Entry</b>	<b>Explanation and action</b>
	ESPQML	numeric (0 to 9999)	<i>Errored seconds-path quarter-hour report threshold</i>  Enter the limit.  The default value is 65.
	SESPDML	numeric (0 to 9999)	<i>Severely errored seconds-path daily report threshold</i>  Enter the limit.  The default value is 100.
	SESPQML	numeric (0 to 9999)	<i>Severely errored seconds-path quarter-hour report threshold</i>  Enter the limit.  The default value is 10.
	UASPDML	numeric (0 to 9999)	<i>Unavailable seconds-path daily report threshold</i>  Enter the limit.  The default value is 10.
	UASPQML	numeric (0 to 9999)	<i>Unavailable seconds-path quarter-hour report threshold</i>  Enter the limit.  The default value is 10.
	SLIPDML	numeric (0 to 9999)	<i>Slips-path daily report threshold</i>  Enter the maintenance limit for slip.  The default value is 4.
	SLIPQML	numeric (0 to 9999)	<i>Slips-path quarter-hour report threshold</i>  Enter the maintenance limit for slip.  The default value is 1.

**CARRMTC** (continued)**SELECTOR = D30**

If the entry in field SELECTOR is D30, datafill refinements described below.

*Note:* The following datafill descriptions include default values. These default values do not apply for all peripheral module types and switch variations.

**Field descriptions for conditional datafill**

Field	Subfield or refinement	Entry	Explanation and action
	CARD	NT6X27AA NT6X27AB NT6X27AC NT6127SA NT6X27BA NT6X27BBNT 6X27BD or NTMX82AA	<p><i>Product engineering code of card</i></p> <p>Enter the product engineering code (PEC) of the card used in the XPM PCM30 carrier for the even bit inversion.</p> <p>The NT6X27AA, NT6X27AB, and NT6X27AC are PCM30 interface cards.</p> <p>The NT6X27BA and NT6X27BB are enhanced PCM30 interface cards.</p> <p><b>Note:</b> The NT6X27BD is for use in a Digital Trunk Controller Offshore with ISDN (DTCOI ) only.</p> <p>The NTMX82AA is a dual PCM30 packet card.</p> <p>The NT6127SA is for Austrian licensee use only.</p> <p>The default value for this field is NT6X27AA.</p>
	VOICELAW	MU_LAW or A_LAW	<p><i>Voice law</i></p> <p>Enter the voice law used in the carrier.</p> <p>The default value for this field is A_LAW.</p>
	NATLBIT	NATL or INTERNATL	<p><i>National bit</i></p> <p>Enter NATL if the national bit used is national. Enter INTERNATL if the national bit is international.</p> <p>The default value for this field is NATL.</p>

**CARRMTC** (continued)**Field descriptions for conditional datafill**

<b>Field</b>	<b>Subfield or refinement</b>	<b>Entry</b>	<b>Explanation and action</b>
	LLFAOST	numeric (0 to 255)	<i>Local loss of frame alignment out-of-service time</i>  Enter the local loss of frame alignment out-of-service time limit. This value is expressed in units of 100 ms.  The default value for this field is 30.
	LLFARST	numeric (0 to 255)	<i>Local loss of frame alignment return-to-service</i>  Enter the local loss of frame alignment return-to-service time limit. This value is expressed in units of 100 ms.  The default value for this field is 30.
	LLFAML	numeric (0 to 255)	<i>Local loss of frame alignment maintenance limit</i>  Enter the local loss of frame alignment maintenance limit. This value is expressed in units of number of hits within a 1-min period.  The default value for this field is 4.
	LLFAOL	numeric (0 to 255)	<i>Local loss of frame alignment out-of-service limit</i>  Enter the local loss of frame alignment out-of-service limit. This value is expressed in units of number of hits within a 5-min period.  The default value for this field is 20.
	LLMAOST	numeric (0 to 255)	<i>Local loss of multiframe alignments out-of-service time</i>  Enter the local loss of multiframe alignments out-of-service time limit. This value is expressed in units of 100 ms.  The default value for this field is 30.

**CARRMTC** (continued)**Field descriptions for conditional datafill**

<b>Field</b>	<b>Subfield or refinement</b>	<b>Entry</b>	<b>Explanation and action</b>
	LLMARST	numeric (0 to 255)	<p><i>Local loss of multiframe alignment return-to-service time</i></p> <p>Enter local loss of multiframe alignment return-to-service time limit. This value is expressed in units of 100 ms.</p> <p>The default value for this field is 30.</p>
	LLMAML	numeric (0 to 255)	<p><i>Local loss of multiframe alignment maintenance limit</i></p> <p>Enter the local loss of multiframe alignment maintenance limit. This value is expressed in units of number of hits within a 1-min period.</p> <p>The default value for this field is 4.</p>
	LLMAOL	numeric (0 to 255)	<p><i>Local loss of multiframe alignment out-of-service limit</i></p> <p>Enter the local loss of multiframe alignment out-of-service limit. This value is expressed in units of number of hits within a 5-min period.</p> <p>The default value for this field is 20.</p>
	RFAIOST	numeric (0 to 255)	<p><i>Remote frame alignment indication out-of-service time</i></p> <p>Enter the remote frame alignment indication out-of-service time. This value is expressed in units of 100 ms.</p> <p>The default value for this field is 30.</p>
	RFAIRST	numeric (0 to 255)	<p><i>Remote frame alignment indication return-to-service time</i></p> <p>Enter the remote frame alignment indication return-to-service time. This value is expressed in units of 100 ms.</p> <p>The default value for this field is 30.</p>

**CARRMTC** (continued)**Field descriptions for conditional datafill**

<b>Field</b>	<b>Subfield or refinement</b>	<b>Entry</b>	<b>Explanation and action</b>
	RFAIML	numeric (0 to 255)	<p><i>Remote frame alignment indication maintenance limit</i></p> <p>Enter the remote frame alignment indication maintenance limit. This value is expressed in units of number of hits within a 1-min period.</p> <p>The default value for this field is 4.</p>
	RFAIOL	numeric (0 to 255)	<p><i>Remote frame alignment indication out-of-service limit</i></p> <p>Enter the remote frame alignment indication out-of-service limit. This value is expressed in units of number of hits within a 5-min period.</p> <p>The default value for this field is 20.</p>
	RMAIOST	numeric (0 to 255)	<p><i>Remote multiframe alignment indication out-of-service time</i></p> <p>Enter the remote multiframe alignment indication out-of-service time. This value is expressed in units of 100 ms.</p> <p>The default value for this field is 30.</p>
	RMAIRST	numeric (0 to 255)	<p><i>Remote multiframe alignment indication return-to-service time</i></p> <p>Enter the remote multiframe alignment indication return-to-service time. This value is expressed in units of 100 ms.</p> <p>The default value for this field is 30.</p>
	RMAIML	numeric (0 to 255)	<p><i>Remote multiframe alignment indication maintenance limit</i></p> <p>Enter the remote multiframe alignment indication maintenance limit. This value is expressed in units of number of hits within a 1-min period.</p> <p>The default value for this field is 4.</p>

**CARRMTC** (continued)**Field descriptions for conditional datafill**

<b>Field</b>	<b>Subfield or refinement</b>	<b>Entry</b>	<b>Explanation and action</b>
	RMAIOL	numeric (0 to 255)	<p><i>Remote multiframe alignment indication out-of-service limit</i></p> <p>Enter the remote multiframe alignment indication out-of-service limit. This value is expressed in units of number of hits within a 5-min period.</p> <p>The default value for this field is 20.</p>
	AISOST	numeric (0 to 255)	<p><i>Alarm indication signal out-of-service time</i></p> <p>Enter the alarm indication signal out-of-service time limit. This value is expressed in units of 100 ms.</p> <p>The default value for this field is 30.</p>
	AISRST	numeric (0 to 255)	<p><i>Alarm indication signal return-to-service time</i></p> <p>Enter the alarm indication signal return-to-service time limit. This value is expressed in units of 100 ms.</p> <p>The default value for this field is 30.</p>
	AISML	numeric (0 to 255)	<p><i>Alarm indication signal maintenance limit</i></p> <p>Enter the alarm indication signal maintenance limit. This value is expressed in units of number of hits within a 1-min period.</p> <p>The default value for this field is 4.</p>
	AISOL	numeric (0 to 255)	<p><i>Alarm indication signal out-of-service limit</i></p> <p>Enter the alarm indication signal out-of-service limit. This value is expressed in units of number of hits within a 5-min period.</p> <p>The default value for this field is 20.</p>
	BERML	numeric (0 to 255)	<p><i>Bit error rate maintenance limit</i></p> <p>Enter the bit error rate maintenance limit. This value is expressed in units of number of hits within a 5-s period.</p> <p>The default value for this field is 130.</p>

**CARRMTC** (continued)**Field descriptions for conditional datafill**

<b>Field</b>	<b>Subfield or refinement</b>	<b>Entry</b>	<b>Explanation and action</b>
	BEROL	numeric (0 to 255)	<p><i>Bit error rate out-of-service limit</i></p> <p>Enter the bit error rate out-of-service limit. This value is expressed in units of number of hits within a 5-s period.</p> <p>The default value for this field is 16.</p>
	SLIPML	numeric (0 to 255)	<p><i>Slip maintenance limit</i></p> <p>Enter the number of slips that are accumulated by the peripheral module, within a 24-h or 1-min interval, before a hit-state warning for slips is raised.</p> <p>The default value for this field is 4.</p>
	SLIPOL	numeric (0 to 255)	<p><i>Slip out-of-service limit</i></p> <p>Enter the number of slips that are accumulated by the peripheral module, within a 24-h or 5-min interval, before a hit-state alarm for slips is raised.</p> <p>The default value for this field is 20.</p>
	SLIPSYNC	Y or N	<p><i>Slip synchronization</i></p> <p>Enter Y (yes) to indicate that the switch operates in a synchronized region and slips are accumulated over 24-h intervals. Enter N (no) to indicate that the switch does not operate in a synchronized region and slips are accumulated over 1-min and 5-min intervals.</p> <p>The default value for this field is N.</p>
	AIS16OST	numeric (0 to 255)	<p><i>Out-of-service time for AIS16 alarm</i></p> <p>Enter the out-of-service time for the AIS16 alarm. This value is expressed in units of 100 ms.</p> <p>The default value for this field is 4.</p>



**CARRMTC** (continued)**Field descriptions for conditional datafill**

<b>Field</b>	<b>Subfield or refinement</b>	<b>Entry</b>	<b>Explanation and action</b>
	AIS16RST	numeric (0 to 255)	<p><i>Return-to-service time for AIS16 alarm</i></p> <p>Enter the return-to-service time for the AIS16 alarm. This value is expressed in units of 100 ms.</p> <p>The default value is for this field is 4.</p>
	AIS16ML	numeric (0 to 255)	<p><i>Maintenance limit for AIS16 alarm</i></p> <p>Enter the maintenance limit for the AIS16 alarm. This value is expressed in units of the number of hits within a 5-min period.</p> <p>The default value for this field is 17.</p>
	AIS16OL	numeric (0 to 255)	<p><i>Out-of-service limit for AIS16 alarm</i></p> <p>Enter the out-of-service limit for the AIS16 alarm. This value is expressed in units of number of hits within a 1-min period.</p> <p>The default value for this field is 255.</p>
	CRC4	Y or N	<p><i>Cyclic redundancy check 4</i></p> <p>Datafill this field to specify whether the cyclic redundancy check 4 (CRC4) must be initiated. Enter Y to initiate the CRC4. Enter N if the CRC4 must not be initiated.</p> <p>The default value for this field is N.</p>
	CRE	Y or N	<p><i>CRC4 remote error reporting</i></p> <p>Datafill this field to specify whether CRC4 remote error (CRE) reporting must be initiated. Enter Y to initiate CRE reporting. Enter N if CRE reporting must not be initiated.</p> <p>The default value for this field is N.</p>
	CRCOST	numeric (0 to 255)	<p><i>Out-of-service time for CRC4 alarm</i></p> <p>Enter the out-of-service time for the CRC4 alarm. This value is expressed in units of 100 ms.</p> <p>The default value for this field is 5.</p>

**CARRMTC** (continued)**Field descriptions for conditional datafill**

<b>Field</b>	<b>Subfield or refinement</b>	<b>Entry</b>	<b>Explanation and action</b>
	CRCRST	numeric (0 to 255)	<i>Return-to-service time for CRC4 alarm</i> Enter the return-to-service time for the CRC4 alarm. This value is expressed in units of 100 ms.  The default value for this field is 5.
	CRCML	numeric (0 to 1023)	<i>Maintenance limit for CRC4 alarm</i> Enter the maintenance limit for the CRC4 alarm. This value is expressed in units of the number of frames within 1000 frames.  The default value for this field is 205.
	CRCOL	numeric (0 to 1023)	<i>Out-of-service limit for CRC4 alarm</i> Enter the out-of-service limit for the CRC4 alarm. This value is expressed in units the number of frames within 1000 frames.  The default value for this field is 914.

**CARRMTC** (continued)**Field descriptions for conditional datafill**

<b>Field</b>	<b>Subfield or refinement</b>	<b>Entry</b>	<b>Explanation and action</b>
	IDLECODE	G714 or Q503	<i>Idle channel bit pattern</i> Enter the CCITT recommended idle-channel bit pattern. The default value for this field is G714.
	SIGNTYPE	CAS CCS CASX CCSIPML or D30RCC	<i>Signaling type</i> This field specifies the signaling type. Enter CAS for channel-associated signaling. Enter CASX for channel-associated signaling used on links from an international line group controller (ILGC) to a remote international line concentrating module (ILCM) or from a PCM30 remote cluster controller (PRCC) to a PCM30 line group controller (PLGC). Enter CCS for common channel signaling. Enter D30RCC if signaling type D30 is being used on the PRCC or if a GPP interface type of V5_2 is datafilled in subfield SELECTOR in table GPPTRNSL. Enter CCSIPML if common channel signaling is used for interperipheral message links.

**CARRMTC** (continued)**SELECTOR = M20**

If the entry in field SELECTOR is M20, datafill the refinements described below.

**Field descriptions for conditional datafill**

Field	Subfield or refinement	Entry	Explanation and action
	CARD	NT6X27JA	<i>Product engineering code of card</i> Enter NT6X27JA (M20 interface card) to specify the product engineering code (PEC) of the card used by the M20 carrier for the Japanese market.
	VOICELAW	MU_LAW or A_LAW	<i>Voice law</i> Enter the voice law used in the carrier.
	FAOST	numeric (0 to 255)	<i>Frame alignment out-of-service time</i> Enter the frame alignment out-of-service time limit. This value is expressed in units of 100 ms.
	FARST	numeric (0 to 255)	<i>Frame alignment return-to-service time</i> Enter the frame alignment return-to-service time limit. This value is expressed in units of 100 ms.
	FAML	numeric (0 to 255)	<i>Frame alignment maintenance limit</i> Enter the frame alignment maintenance limit. This corresponds to the number of hits accumulated over a 1-min period.
	FAOL	numeric (0 to 255)	<i>Frame alignment out-of-service limit</i> Enter the frame alignment out-of-service limit. This corresponds to the number of hits accumulated over a 5-min period.
	ALOST	numeric (0 to 255)	<i>Alarm out-of-service time</i> Enter the alarm out-of-service time limit. This value is expressed in units of 100 ms.
	ALRST	numeric (0 to 255)	<i>Alarm return-to-service time</i> Enter the alarm return-to-service time limit. This value is expressed in units of 100 ms.

**CARRMTC** (continued)**Field descriptions for conditional datafill**

<b>Field</b>	<b>Subfield or refinement</b>	<b>Entry</b>	<b>Explanation and action</b>
	ALML	numeric (0 to 255)	<i>Alarm maintenance limit</i> Enter the alarm maintenance limit. This corresponds to the number of hits accumulated over a 1-min period.
	ALOL	numeric (0 to 255)	<i>Alarm out-of-service limit</i> Enter the alarm out-of-service limit. This corresponds to the number of hits accumulated over a 5-min period.
	AISOST	numeric (0 to 255)	<i>Alarm indication signal out-of-service time</i> Enter the alarm indication signal out-of-service time limit. This value is expressed in units of 100 ms.
	AISRST	numeric (0 to 255)	<i>Alarm indication signal return-to-service time</i> Enter the alarm indication signal return-to-service time limit. This value is expressed in units of 100 ms.
	AISML	numeric (0 to 255)	<i>Alarm indication signal maintenance limit</i> Enter the alarm indication signal maintenance limit. This corresponds to the number of hits accumulated over a 1-min period.
	AISOL	numeric (0 to 255)	<i>Alarm indication signal out-of-service limit</i> Enter the alarm indication signal out-of-service limit. This corresponds to the number of hits accumulated over a 5-min period.
	TNR1OST	numeric (0 to 255)	<i>TNR1 out-of-service time</i> Enter the TNR1 out-of-service time limit. This value is expressed in units of 100 ms.
	TNR1RST	numeric (0 to 255)	<i>TNR1 return-to-service time</i> Enter the TRN1 return-to-service time limit. This value is expressed in units of 100 ms.

**CARRMTC** (continued)**Field descriptions for conditional datafill**

<b>Field</b>	<b>Subfield or refinement</b>	<b>Entry</b>	<b>Explanation and action</b>
	TNR1ML	numeric (0 to 255)	<i>TNR1 maintenance limit</i> Enter the TNR1 maintenance limit. This corresponds to the number of hits accumulated over a 1-min period.
	TNR1OL	numeric (0 to 255)	<i>TNR1 out-of-service limit</i> Enter the TNR1 out-of-service limit. This corresponds to the number of hits accumulated over a 5-min period.
	TNR2OST	numeric (0 to 255)	<i>TNR2 out-of-service time</i> Enter the TNR2 out-of-service time limit. This value is expressed in units of 100 ms.
	TNR2RST	numeric (0 to 255)	<i>TNR2 return-to-service time</i> Enter the TNR2 return-to-service time limit. This value is expressed in units of 100 ms.
	TNR2ML	numeric (0 to 255)	<i>TNR2 maintenance limit</i> Enter the TNR2 maintenance limit. This corresponds to the number of hits accumulated over a 1-min period.
	TNR2OL	numeric (0 to 255)	<i>TNR2 out-of-service limit</i> Enter the TNR2 out-of-service limit. This corresponds to the number of hits accumulated over a 5-min period.
	SLIPML	numeric (0 to 255)	<i>Slip maintenance limit</i> Enter the number of slips that are accumulated by the peripheral module, within a 24-h or 1-min interval, before a hit-state warning for slip is raised.
	SLIPOL	numeric (0 to 255)	<i>Slip out-of-service limit</i> Enter the number of slips that are accumulated by the peripheral module, within a 24-h or 5-min interval, before a hit-state alarm for slip is raised.

**CARRMTC** (continued)**Field descriptions for conditional datafill**

Field	Subfield or refinement	Entry	Explanation and action
	IDLECODE	G714M or Q503M	<i>Idle channel bit pattern</i> Enter the CCITT recommended idle channel bit pattern.
	SIGNTYPE	CAS CASX CCS CCSIPML or D30RCC	<i>Signaling type</i> This field specifies the signaling type. Enter CAS for channel-associated signaling. Enter CASX for channel-associated signaling used on links from an international line group controller (ILGC) to a remote international line concentrating module (ILCM). Enter CCS for common channel signaling. Enter D30RCC if signaling type D30 is being used on the PCM30 remote cluster controller. Enter CCSIPML if common channel signaling is used for interperipheral message links.

**SELECTOR = TTC**

If the entry in field SELECTOR is TTC, datafill the refinements described below.

**Field descriptions for conditional datafill**

Field	Subfield or refinement	Entry	Explanation and action
	CARD	NT6X27JB	<i>Product engineering code of card</i> Enter NT6X27JB (TTC interface card) to specify the product engineering code (PEC) of the card used by the telecommunication technical committee (TTC) carrier for the Japanese market.
	VOICELAW	MU_LAW or A_LAW	<i>Voice law</i> Enter the voice law used in the carrier.

**CARRMTC** (continued)**Field descriptions for conditional datafill**

<b>Field</b>	<b>Subfield or refinement</b>	<b>Entry</b>	<b>Explanation and action</b>
	FAOST	numeric (0 to 255)	<i>Frame alignment out-of-service time</i> Enter the frame alignment out-of-service time limit. This value is expressed in units of 100 ms.
	FARST	numeric (0 to 255)	<i>Frame alignment return-to-service time</i> Enter the frame alignment return-to-service time limit. This value is expressed in units of 100 ms.
	FAML	numeric (0 to 255)	<i>Frame alignment maintenance limit</i> Enter the frame alignment maintenance limit. This corresponds to the number of hits accumulated over a 1-min period.
	FAOL	numeric (0 to 255)	<i>Frame alignment out-of-service limit</i> Enter the frame alignment out-of-service limit. This corresponds to the number of hits accumulated over a 5-min period.
	MAOST	numeric (0 to 255)	<i>Multiframe alignment out-of-service time</i> Enter the multiframe alignment out-of-service time limit. This value is expressed in units of 100 ms.
	MARST	numeric (0 to 255)	<i>Multiframe alignment return-to-service time</i> Enter the multiframe alignment return-to-service time limit. This value is expressed in units of 100 ms.
	MAML	numeric (0 to 255)	<i>Multiframe alignment maintenance limit</i> Enter the multiframe alignment maintenance limit. This corresponds to the number of hits accumulated over a 1-min period.
	MAOL	numeric (0 to 255)	<i>Multiframe alignment out-of-service limit</i> Enter the multiframe alignment out-of-service limit. This corresponds to the number of hits accumulated over a 5-min period.



**CARRMTC** (continued)**Field descriptions for conditional datafill**

<b>Field</b>	<b>Subfield or refinement</b>	<b>Entry</b>	<b>Explanation and action</b>
	SBOST	numeric (0 to 255)	<i>S-bit out-of-service time</i> Enter the S-bit out-of-service time limit. This value is expressed in units of 100 ms.
	SBRST	numeric (0 to 255)	<i>S-bit return-to-service time</i> Enter the S-bit return-to-service time limit. This value is expressed in units of 100 ms.
	SBML	numeric (0 to 255)	<i>S-bit maintenance limit</i> Enter the S-bit maintenance limit. This corresponds to the number of hits accumulated over a 1-min period.
	SBOL	numeric (0 to 255)	<i>S-bit out-of-service limit</i> Enter the S-bit out-of-service limit. This corresponds to the number of hits accumulated over a 5-min period.
	AISOST	numeric (0 to 255)	<i>Alarm indication signal out-of-service time</i> Enter the alarm indication signal out-of-service time limit. This value is expressed in units of 100 ms.
	AISRST	numeric (0 to 255)	<i>Alarm indication signal return-to-service time</i> Enter alarm indication signal return-to-service time limit. This value is expressed in units of 100 ms.
	AISML	numeric (0 to 255)	<i>Alarm indication signal maintenance limit</i> Enter the alarm indication signal maintenance limit. This corresponds to the number of hits accumulated over a 1-min period.
	AISOL	numeric (0 to 255)	<i>Alarm indication signal out-of-service limit</i> Enter the alarm indication signal out-of-service limit. This corresponds to the number of hits accumulated over a 5-min period.

**CARRMTC** (continued)**Field descriptions for conditional datafill**

<b>Field</b>	<b>Subfield or refinement</b>	<b>Entry</b>	<b>Explanation and action</b>
	SLIPML	numeric (0 to 255)	<i>Slip maintenance limit</i> Enter the number of slips that are accumulated by the peripheral module, within a 24-h or 1-min interval, before a hit-state alarm for slip is raised.
	SLIPOL	numeric (0 to 255)	<i>Slip out-of-service limit</i> Enter the number of slips that are accumulated by the peripheral module, within a 24-h or 5-min interval, before a hit-state alarm for slip is raised.
	IDLECODE	G714M or Q503M	<i>Idle channel bit pattern</i> Enter the CCITT recommended idle-channel bit pattern. An entry outside of this range is invalid.
	SIGNTYPE	CAS, CASX, CCS, CCSIPML, or D30RCC	<i>Signaling type</i> This field specifies the signaling type. Enter CAS for channel-associated signaling. Enter CASX for channel-associated signaling used on links from an international line group controller (ILGC) to a remote international line concentrating module (ILCM). Enter CCS for common channel signaling. Enter D30RCC if signaling type D30 is being used on the PCM30 remote cluster controller. Enter CCSIPML if common channel signaling is used for interperipheral message links.

**CARRMTC** (continued)**SELECTOR = FRT1**

If the entry in field SELECTOR is FRT1, datafill the refinements described below.

**Field descriptions for conditional datafill**

Field	Subfield or refinement	Entry	Explanation and action
	CARD	NTEX30AA	<i>Product engineering code of card</i> Enter NTEX30AA to specify the product engineering code (PEC) of the T1 analog paddle board used in the FRT-1 carrier.
	FF	SF or ESF	<i>Frame format</i> Enter the value SF for standard format or ESF for extended superframe format.
	BERB	BPV or CRC6	<i>Bit error rate base</i> Enter BPV for bipolar violation. Enter CRC6 for cyclic redundancy check #6. CRC6 enables an extended superframe relay (ESF) carrier to be used by a frame relay interface unit (FRIU).
	IAT	Y or N	<i>Inhibit alarm transmit</i> Enter Y (yes) to inhibit alarm transmissions. Enter N (no) to specify that the alarm transmissions are not to be inhibited.  The default value is N.
	LCGAST	numeric (1 to 9 999)	<i>Local carrier group alarm set threshold</i> Enter a number from 1 to 9 999.  The default value is 250, where 100 is equivalent to 1 s.
	LCGACL	numeric (1 to 9 999)	<i>Local carrier group alarm clear threshold</i> Enter a number from 1 to 9 999.  The default value is 1500, where 100 is equivalent to 1 s.

**CARRMTC** (continued)**Field descriptions for conditional datafill**

<b>Field</b>	<b>Subfield or refinement</b>	<b>Entry</b>	<b>Explanation and action</b>
	RCGAST	numeric (1 to 9 999)	<i>Remote carrier group alarm set threshold</i> Enter a number from 1 to 9 999. The default value is 50, where 100 is equivalent to 1 s.
	RCGACL	numeric (1 to 9 999)	<i>Remote carrier group alarm clear threshold</i> Enter a number from 1 to 9 999. The default value is 50, where 100 is equivalent to 1 s.
	AISST	numeric (1 to 9 999)	<i>Alarm indication signal set threshold</i> Enter a number from 1 to 9 999. The default value is 50, where 100 is equivalent to 1 s.
	AISCL	numeric (1 to 9 999)	<i>Alarm indication signal clear threshold</i> Enter a number from 1 to 9 999. The default value is 1500, where 100 is equivalent to 1 s.
	BEROS	numeric (0 to 15)	<i>Bit error rate out-of-service limit</i> Enter a number from 3 to 9. Entries outside this range are not valid. The BEROS value cannot be greater than the value submitted for BERML (Any other values are rejected by the table control system). The default value is 6, where BER = 10 <sup>-6</sup> represents 1 error in 1 s.
	BERML	numeric (0 to 15)	<i>Bit error rate maintenance limit</i> Enter a number from 3 to 9. Entries outside this range are not valid and are rejected by the table control system. The default value is 8.

**CARRMTC** (continued)**Field descriptions for conditional datafill**

<b>Field</b>	<b>Subfield or refinement</b>	<b>Entry</b>	<b>Explanation and action</b>
	ES	numeric (0 to 9 999)	<i>Errored seconds threshold</i> Enter a number from 0 to 9 999. The default value is 864.
	SES	numeric (0 to 9 999)	<i>Severe errored seconds</i> Enter a number from 0 to 9 999. The default value is 100.
	SESCALC	BEROS CRC6 or STD	<i>Severe errored seconds threshold</i> Datafill this field to specify the severe errored seconds (SES) threshold. Enter BEROS (bit error rate out-of-service limit) to specify that the SES calculation is to be based on the current BEROS limit. Enter CRC6 (cyclic redundancy check #6) to define an extended superframe relay (ESF) carrier for the frame relay interface unit (FRIU). Enter STD (standard) to specify that the SES calculation is to be based on a BER value of 10 <sup>-3</sup> . The default value for this field is BEROS.
	FRAMEML	numeric (0 to 9 999)	<i>Frame bit error maintenance limit</i> Enter a number from 0 to 9 999. The default value is 17.
	FRAMEOS	numeric (0 to 9 999)	<i>Frame bit error out-of-service limit</i> Enter a number from 0 to 9 999. The default value is 511.

**CARRMTC** (continued)**SELECTOR = NDS0**

If the entry in field SELECTOR is NDS0, datafill the refinements described below.

**Field descriptions for conditional datafill**

Field	Subfield or refinement	Entry	Explanation and action
	CARD	NT6X55CA	<p><i>Product engineering code of card</i></p> <p>Enter NT6X55CA to specify the product engineering code (PEC) for the 8-port 64-kbit interface card that is used as the NDS0 carrier interface card.</p>
	DATARATE	64K	<p><i>Data rate</i></p> <p>Enter the bit rate at which the carrier operates.</p>
	CLOCKOPT	BELLDS0 BELLTST CCITTCEN CCITTCMD CCITTCTL or CCITTSUB	<p><i>Clock options</i></p> <p>Enter one of the six options used to select the type of clocking used for this carrier. These six options include</p> <ul style="list-style-type: none"> <li>• BELLDS0Bellcore DS-0 64K</li> <li>• BELLTSTBellcore testing</li> <li>• CCITTCENCCITT centralized</li> <li>• CCITTCMDCCITT centralized (modified)</li> <li>• CCITTCTLCCITT contradirectional controlling</li> <li>• CCITTSUBCCITT contradirectional subordinate</li> </ul> <p>If the card option is NT6X55BA (64-kbit access card) or NT6X55AB (DS-0 interface card), a warning is produced that the operating company personnel have no permission to datafill the other clock options.</p>
	LOSOST	numeric (0 to 255)	<p><i>Out-of-service time for LOS</i></p> <p>Enter a number between 0 and 255 to represent the out-of-service time for loss of signal (LOS). This value is expressed in units of 100 ms.</p>

**CARRMTC** (continued)**Field descriptions for conditional datafill**

<b>Field</b>	<b>Subfield or refinement</b>	<b>Entry</b>	<b>Explanation and action</b>
	LOSRST	numeric (0 to 255)	<i>Return-to-service time for LOS</i> Enter a number between 0 and 255 to represent the return-to-service time for LOS. This value is expressed in units of 100 ms.
	LOSML	numeric (0 to 255)	<i>Maintenance time for LOS</i> Enter a number between 0 and 255 to represent the maintenance time for LOS. This corresponds to the number of hits accumulated over a 1-min period.
	LOSOL	numeric (0 to 255)	<i>Out-of-service limit for LOS</i> Enter a number between 0 and 255 to represent the out-of-service limit for LOS. This corresponds to the number of hits accumulated over a 5-min period.
	AISOST	numeric (0 to 255)	<i>Out-of-service time for AIS</i> Enter a number between 0 and 255 to represent the out-of-service time for alarm indication signal (AIS). This value is expressed in units of 100 ms.
	AISRST	numeri (0 to 255)	<i>Return-to-service for AIS</i> Enter a number between 0 and 255 to represent the return-to-service time for AIS. This value is expressed in units of 100 ms.
	AISML	numeric (0 to 255)	<i>Maintenance time for AIS</i> Enter a number between 0 and 255 to represent the maintenance time for AIS. This corresponds to the number of hits accumulated over a 1-min period.
	AISOL	numeric (0 to 255)	<i>Out-of-service limit for AIS</i> Enter a number between 0 and 255 to represent the out-of-service limit for AIS. This corresponds to the number of hits accumulated over a 5-min period.

**CARRMTC** (continued)**Field descriptions for conditional datafill**

<b>Field</b>	<b>Subfield or refinement</b>	<b>Entry</b>	<b>Explanation and action</b>
	CLKLOST	numeric (0 to 255)	<i>Out-of-service for CLKL</i> Enter a number between 0 and 255 to represent out-of-service time for transmit or receive clock loss (CLKL). This value is expressed in units of 100 ms.
	CLKLRST	numeric (0 to 255)	<i>Return-to-service for CLKL</i> Enter a number between 0 and 255 to represent return-to-service for CLKL. This value is expressed in units of 100 ms.
	CLKLML	numeric (0 to 255)	<i>Maintenance time for CLKL</i> Enter a number between 0 and 255 to represent the maintenance time for CLKL. This corresponds to the number of hits accumulated over a 1-min period.
	CLKLOL	numeric (0 to 255)	<i>Out-of-service for CLKL</i> Enter a number between 0 and 255 to represent the out-of-service limit for CLKL. This corresponds to the number of hits accumulated over a 5-min period.
	BPVLOST	numeric (0 to 255)	<i>Out-of-service for BPVL</i> Enter a number between 0 and 255 to represent the out-of-service time for bipolar violation loss (BPVL) on transmit or receive. This value is expressed in units of 100 ms.
	BPVLRST	numeric (0 to 255)	<i>Return-to-service for BPVL</i> Enter a number between 0 and 255 to represent the return-to-service for BPVL. This value is expressed in units of 100 ms.
	BPVLML	numeric (0 to 255)	<i>Maintenance for BPVL</i> Enter a number between 0 and 255 to represent the maintenance time for BPVL. This corresponds to the number of hits accumulated over a 1-min period.



**CARRMTC** (continued)**Field descriptions for conditional datafill**

<b>Field</b>	<b>Subfield or refinement</b>	<b>Entry</b>	<b>Explanation and action</b>
	BPVLOL	numeric (0 to 255)	<i>Out-of-service for BPVL</i> Enter a number between 0 and 255 to represent out-of-service limit for BPVL. This corresponds to the number of hits accumulated over a 5-min period.
	SLIPOST	numeric (0 to 255)	<i>Out-of-service for slip</i> Enter a number between 0 and 255 to represent out-of-service time for slip. This value is expressed in units of 100 ms.
	SLIPRST	numeric (0 to 255)	<i>Return-to-service for slip</i> Enter a number between 0 and 255 to represent return-to-service time for slip. This value is expressed in units of 100 ms.
	SLIPML	numeric (0 to 255)	<i>Maintenance for slip</i> Enter a number between 0 and 255 to represent the maintenance time for slip. This corresponds to the number of hits accumulated over a 1-min period.
	SLIPOL	numeric (0 to 255)	<i>Out-of-service for slip</i> Enter a number between 0 and 255 to represent the out-of-service limit for slip. This corresponds to the number of hits accumulated over a 5-min period.

**CARRMTC** (continued)**SELECTOR = SONET**

If the entry in field SELECTOR is SONET, datafill the refinements described below.

**Field descriptions for conditional datafill**

Field	Subfield or refinement	Entry	Explanation and action
	CARD (BCS36-)	NTMX68AA	<i>Product engineering code of card</i> Enter NTMX68AA to specify the product engineering code (PEC) of the Synchronous Optical Network (SONET) direct fiber interface (DFI) card. The default value is NTMX68AA.
	VOICELAW (BCS36-)	MU_LAW or A_LAW	<i>Voice law</i> Enter the voice law used in the carrier. The default value is MU_LAW.
	SLIPML (BCS36-)	numeric (0 to 9 999)	<i>Slip maintenance limit</i> Enter the number of slips that are accumulated within a 1-min interval, before a hit-state alarm for slip is raised. The default value is 4.
	SLIPOL (BCS36-)	numeric (0 to 9 999)	<i>Slip out-of-service limit</i> Enter the number of slips that are accumulated within a 5-min interval, before a hit-state alarm for slip is raised. The default value is 255.
	REDST (BCS36-)	numeric (0 to 100)	<i>Red alarm set time</i> Enter the time interval, in units of 0.1 s, for the detection and reporting of a continuous fault. The default value is 25 (2.5 s).
	REDCL (BCS36-)	numeric (0 to 200)	<i>Red alarm clear time</i> Enter the time interval, in units of 0.1 s, that a SONET carrier must remain sane before a red alarm state can be cleared. The default value is 150 (15 s).

**CARRMTC** (continued)**Field descriptions for conditional datafill**

<b>Field</b>	<b>Subfield or refinement</b>	<b>Entry</b>	<b>Explanation and action</b>
	REDSLPE (BCS36-)	numeric (4 to 15)	<p><i>Red alarm set limit parameter entry</i></p> <p>Enter the red alarm parameter defining the count-up to count-down ratio for the accumulation of red alarm time. Field REDSLPE is used to accumulate repeat occurrences of short intermittent faults. Field REDSLPE defines the ratio between increase and decrease counter law.</p> <p>The default value is 4.</p>
	AISST (BCS36-)	numeric (0 to 100)	<p><i>Alarm indication signal alarm set time</i></p> <p>Enter the alarm indication signal (AIS) alarm set time in units of 0.1 s. If a continuous fault is detected during this interval, an alarm hit is reported.</p> <p>The default value is 25 (2.5 s).</p>
	AISCL (BCS36-)	numeric (0 to 200)	<p><i>AIS alarm clear time</i></p> <p>Enter the time interval, in units of 0.1 s, that a SONET carrier must remain sane before an AIS alarm state can be cleared.</p> <p>The default value is 150 (15 s).</p>
	AISLPE (BCS36-)	numeric (4 to 15)	<p><i>AIS set limit parameter entry</i></p> <p>Enter the AIS alarm parameter defining the count-up to count-down ratio for the accumulation of AIS alarm time. Field REDSLPE is used to accumulate repeat occurrences of short intermittent faults. Field REDSLPE defines the ratio between increase and decrease counter law.</p> <p>The default value is 4.</p>
	LFRST (BCS36-)	numeric (0 to 100)	<p><i>Line far-end-receive-failure alarm set time</i></p> <p>Enter the line far-end-receive-failure (LFRF) alarm set time in units of 0.1 s. If a continuous fault is detected during this interval, an alarm hit is reported.</p> <p>The default value is 25 (2.5 s).</p>

**CARRMTC** (continued)**Field descriptions for conditional datafill**

<b>Field</b>	<b>Subfield or refinement</b>	<b>Entry</b>	<b>Explanation and action</b>
	LFERCL (BCS36-)	numeric (0 to 200)	<i>LFERF alarm clear time</i> Enter the time interval, in units of 0.1 s, that a SONENT carrier must remain sane before an LFERF alarm state can be cleared. The default value is 150 (15 s).
	PTRML (BCS36-)	numeric (0 to 9 999)	<i>Loss of pointer maintenance limit</i> Enter the number of hits that are accumulated within a 1-min interval, before a hit-state alarm for slip is raised. The default value is 20.
	PTROL (BCS36-)	numeric (0 to 9 999)	<i>Loss of pointer out-of-service limit</i> Enter the number of hits that are accumulated within a 5-min interval, before a hit-state alarm for slip is raised. The default value is 250.
	FRAMEML (BCS36-)	numeric (0 to 9 999)	<i>Loss of frame maintenance limit</i> Enter the number of hits that are accumulated within a 1-min interval, before a hit-state alarm for slip is raised. The default value is 20.
	FRAMEOL (BCS36-)	numeric (0 to 9 999)	<i>Loss of frame out-of-service limit</i> Enter the number of hits that are accumulated within a 5-min interval, before a hit-state alarm for slip is raised. The default value is 250.
	SIGML (BCS36-)	numeric (0 to 9 999)	<i>Loss of signal maintenance limit</i> Enter the number of hits that are accumulated within a 1-min interval, before a hit-state alarm for slip is raised. The default value is 20.

**CARRMTC** (continued)**Field descriptions for conditional datafill**

<b>Field</b>	<b>Subfield or refinement</b>	<b>Entry</b>	<b>Explanation and action</b>
	SIGOL (BCS36-)	numeric (0 to 9 999)	<p><i>Loss of signal out-of-service limit</i></p> <p>Enter the number of hits that are accumulated within a 5-min interval, before a hit-state alarm for slip is raised.</p> <p>The default value is 250.</p>
	SBERML (BCS36-)	numeric (3 to 9)	<p><i>STS-1 bit error rate maintenance limit</i></p> <p>Enter the number of hits that are accumulated within a 1-min interval, before a hit-state alarm for slip is raised. Entries outside this range are invalid.</p> <p>The default value is 7.</p>
	SBEROL (BCS36-)	numeric (3 to 9)	<p><i>STS-1 bit error rate out-of-service limit</i></p> <p>Enter the number of hits that are accumulated within a 5-min interval, before a hit-state alarm for slip is raised. Entries outside this range are invalid.</p> <p>The default value is 4.</p>
	VBERML (BCS36-)	numeric (3 to 9)	<p><i>VT1.5 bit error rate maintenance limit</i></p> <p>Enter the number of slips that are accumulated by the peripheral module, within a 1-min interval, before a hit-state alarm for slip is raised. Entries outside this range are invalid.</p> <p>The default value is 7.</p>
	VBEROL (BCS36-)	numeric (3 to 9)	<p><i>VT1.5 bit error rate out-of-service limit</i></p> <p>Enter the number of slips that are accumulated by the peripheral module, within a 5-min interval, before a hit-state alarm for slip is raised. Entries outside this range are invalid.</p> <p>The default value is 4.</p>

**CARRMTC** (continued)**Datafill examples**

Examples of datafill for table CARRMTC with field CSPMTYPE set to DCM or DTC.

**Note:** The DEFAULT templates are added by the system and they cannot be deleted. The operating company is allowed to change them. The default for IAC, LGC, LTC, RCC, SMR, SMS, and SMU is identical to that of DTC.

**MAP display example for table CARRMTC**

CSPMTYPE	TMPLTNM	RTSML	RTSOL	ATTR
DCM	DEFAULT	255	255	DS1 NT2X35AB 17 511 4 255
DTC	DEFAULT	255	255	DS1 NT6X50AA MU_LAW SF BPV NILDL N 250 1000 50 50 100 1000 3 6 864 100 17 511 4 255

An example of datafill for table CARRMTC with field CSPMTYPE set to RCO2 is shown below.

**MAP display example for table CARRMTC**

CSPMTYPE	TMPLTNM	RTSML	RTSOL	ATTR
RCO2	DEFAULT	255	255	D30 NTMX82AA A_LAW NATL 4 4 17 20 30 30 4 20 30 30 4 20 30 30 4 20 30 30 5 20 20 4 4 20 Y 254 253 17 255 N N 5 5 205 42 G714 D30RCC

An example of datafill for table CARRMTC with field CSPMTYPE set to SMA is shown below.

**CARRMTC** (continued)

**MAP display example for table CARRMTC**

CSPMTYPE	TMPLTNM	RTSML	RTSOL	ATTR
SMA	DEFAULT	255	255	DS1 NT6X50AA MU_LAW SF B8ZS BPV NILDL N 250 1000 50 50 150 1000 3 6 864 100 17 511 4 255

An example of datafill for table CARRMTC with field CSPMTYPE set to LTC and TMPLTNM set to ESFB8ZS is shown below.

**MAP display example for table CARRMTC**

CSPMTYPE	TMPLTNM	RTSML	RTSOL	ATTR
LTC	ESFB8ZS	255	255	DS1 NT6X50AB MU_LAW ESF B8ZS BPV NILDL N 250 1000 50 50 150 1000 3 6 864 100 17 511 4 255

An example of datafill for table CARRMTC with field CSPMTYPE set to LTC and TMPLTNM set to GWIP is shown below.

**MAP display example for table CARRMTC**

CSPMTYPE	TMPLTNM	RTSML	RTSOL	ATTR
LTC	GWIP	255	255	DS1 NT7X07AA MU_LAW SF ZCS BPV NILDL N 250 1000 50 50 150 1000 3 6 864 100 17 511 4 255

An example of datafill for table CARRMTC of an SMS in mode 1 or mode 2 is shown below.

**CARRMTC** (continued)**MAP display example for table CARRMTC**

CSPMTYPE	TMPLTNM	RTSML	RTSOL	ATTR
SMS	MODE1OR2	255	255	DS1 NTEX85AA MU_LAW SF ZCS BPV NILDL Y 40 200 50 50 150 1000 3 6 864 100 17 511 4 255

Examples of datafill for table CARRMTC with field SELECTOR set to FRT1 are shown below.

**MAP display example for table CARRMTC**

CSPMTYPE	TMPLTNM	RTSML	RTSOL	ATTR
FRIU	DEFAULT	255	255	FRT1 NTEX30AA SF BPV N 250 1500 50 50 50 1500 8 6 864 100 BEROS 17 17
FRIU	BELL02	10	25	FRT1 NTEX30AA SF BPV N 15 30 30 30 30 100 3 6 864 100 STD 17 511

Examples of datafill for table CARRMTC with field SELECTOR set to HLIU are shown below.

**MAP display example for table CARRMTC**

CSPMTYPE	TMPLTNM	RTSML	RTSOL	ATTR
HLIU	DEFAULT	255	255	DS1 NTEX78AA ESF 250 2000 0 0 250 2000 250 1000 648 65 100 10 10 10 4 1

An example of datafill for table CARRMTC with field CSPMTYPE set to PDTC and field SELECTOR equal to NDS0 is shown below.



**CARRMTC** (continued)**MAP display example for table CARRMTC**

CSPMTYPE	TMPLTNM	RTSML	RTSOL	ATTR
PDTC	NDS0DEF	255	255	NDS0 NT6X55CA 64K CCITTSUB 5 5 100 100 5 5 100 100 5 5 100 100 5 5 100 100 5 5 100 100

An example of datafill for table CARRMTC with field CSPMTYPE set to DTCOI and field SELECTOR equal to D30 is shown below.

**MAP display example for table CARRMTC**

CSPMTYPE	TMPLTNM	RTSML	RTSOL	ATTR
PDTC	NDS0DEF	255	255	D30 NT6X27BD 64K CCITTSUB 5 5 100 100 5 5 100 100 5 5 100 100 5 5 100 100 5 5 100 100

**Table history****SN06 (DMS)**

Added information on the impact to IAMs of setting the VOICELAW parameter for Q00671190.

**MMP15**

Added PLGC UNIREM value to field CSPMTYPE for feature AF6856.

**CCM13**

Added MAP display example for GWIP. Added Gateway information to fields TMPLTNM, RTSML, and RTSOL.

**CSP11**

Removed HLIU datafill restrictions.

**EUR09**

Added NT6X27BD card field and provided conditional datafill.

---

**CARRMTC** (end)

---

**STP04.0**

Removed HLIU datafill restrictions. Added an HLIU MAP display example.

**CSP07**

Added HLIU to fields CSPMTYPE. Added NTEX78AA to CARD field and provided conditional datafill.

**APC06**

Added clear channel (64kb/s) signaling and frame format B8ZS for the HDLC protocol, required for the LAPD messaging for the LTC+. Provisioned for Japan only, for the RLCM-EDC.

**APC05.1**

Added GPP V5.2 signalling type of D30RCC in field SIGNTYPE when CSPMTYPE is datafilled GPP and interface type is V5.2. Added GPP V5.2 datafill example.

**CSP03**

Added GPP to fields CSPMTYPE and SELECTOR. Added GPP CAS datafill example.

**BCS36**

Selector SONET was added.



**CARRTRF** (end)**Field descriptions (Sheet 2 of 2)**

Field	Subfield or refinement	Entry	Explanation and action
	CLGNXX	200 to 999	Calling NXX. Enter the NXX (station code) of the paying party.
TARIFF		alphanumeric (1 to 16 characters)	Tariff. Enter a tariff name as previously datafilled in table TARIFF.

**Datafill example**

The following example shows sample datafill for table CARRTRF.

**MAP display example for table CARRTRF**

KEY	TARIFF
CARR1 212 220	CARR1TRF1

**Table history****BCS36**

Tables TARIFF and PICNAME were added to the datafill sequence. Field KEY was added, and fields CARNAME, CLGNPA, and CLGNXX became subfields of field KEY.

## CATCLASS

---

### Table name

R2 Protocol Category Classification Table

### Functional description

Regional signaling systems number 2 (R2) use register signaling to transfer information about a call between two ends of a trunk. The R2 systems are multifrequency compelled (MFC) systems. The R2 systems send signals in one direction. The R2 systems receive acknowledgment tones. A protocol specification describes the information the R2 system transfers.

The R2 signaling applies to the DMS-100, DMS-200, and DMS-100/200 switches.

Table CATCLASS identifies the following categories in an R2 protocol:

- calling categories
- billing categories
- billing and calling categories

Calling categories are activities that indicate the category of the calling subscriber in response to the REQ\_CAT activity. Billing categories are activities that indicate the automatic number identification (ANI) phase category of the calling subscriber in response to the REQ\_DN\_CAT activity. This table makes sure that the categories outgoing from the DMS are correct. This table does not make sure that the categories the DMS receives are correct.

A group of a user-defined string of a maximum of eight characters and an R2 category activity indexes each CATCLASS tuple.

Refer to table SIGACT for additional information on R2 activities.

### Datafill sequence and meaning

You must enter data in the following tables before you enter data in table CATCLASS:

- table ACTSIG
- table ACTCTL

### Table size

0 to 3840 tuples

**CATCLASS** (continued)**Datafill**

Datafill for table CATCLASS appears in the following table.

**Field descriptions (Sheet 1 of 2)**

Field	Subfield or refinement	Entry	Explanation and action
IDX		see subfields	<i>Catclass index.</i> This field contains subfields CATNAME and CATEGORY. These subfields represent the index in table CATCLASS.
	CATNAME	alphanumeric (to a maximum of 8 characters)	<i>Catclass name.</i> Enter the category name.
	CATEGORY	ANI_FAILURE ATME COIN DATA FREE_CALL LOCAL_COIN MTC_EQ OPER OPER_INTL PBX PRIORITY REGULAR REGULAR_INTL SHARED_1 SHARED_2 SHARED_3 SPARE_CAT1 SPARE_CAT2 TIME_AND_CHG TOLL_COIN or UNIT_FEE_COIN TOLL_AUTO	<p><i>Category.</i> Enter the category assigned to a class. For additional descriptions, refer to table SIGACT or table TOPS.</p> <p>ANI_FAILURE (automatic number identification failure)</p> <p>ATME (call originated by automatic test and measurement equipment)</p> <p>COIN (coin)</p> <p>DATA (data call)</p> <p><b>Note:</b> The DATA category prevents double connections to the call for the duration of the call. The system transmits data. Break-in tones or multiple voice connections cause transmission errors.</p> <p>FREE_CALL (free call-handled the same as a REGULAR call. The mark of the call is NOAMA)</p> <p>LOCAL_COIN (call originated from local public telephone)</p> <p>MTC_EQ (maintenance equipment)</p> <p><b>Note:</b> The MTC_EQ calls originate from the MAP or test equipment.</p>

## CATCLASS (continued)

### Field descriptions (Sheet 2 of 2)

Field	Subfield or refinement	Entry	Explanation and action
	CATEGORY( continued)		OPER (operator) OPER_INTL (international operator originated call) PBX (call from a private branch exchange) PRIORITY (priority subscriber) REGULAR (regular subscriber or category of subscriber is not known) REGULAR_INTL (international direct dial call) SHARED_1, SHARED_2, SHARED_3 (first, second, or third subscriber on a party line) SPARE_CAT1, SPARE_CAT2 (spare categories) TIME_AND_CHG (subscriber requests time and charge) TOLL_COIN (call that originates from a long distance public telephone) UNIT_FEE_COIN (unit fee coinbox call) TOLL_AUTO (automatic toll call)
	CATDATA	BILLING BOTH or CALLING	<i>Class of category.</i> Enter the class of the category that appears in the CATEGORY field.

### Datavill example

Sample datavill for table CATCLASS appears in the following example.

### MAP display example for table CATCLASS

IDX CATDATA			
CATIDX	REGULAR	BOTH	
CATIDX	OPER	BOTH	

**CATCLASS** (end)

---

**Table history**

**BCS36**

Add entries LOCAL\_COIN and TOLL\_COIN to subfield CATEGORY in BCS36.

**BCS34**

Table CATCLASS was introduced in BCS34.



## CATCODES

### Table name

AMR5 Category Code Table

### Functional description

Table CATCODES is required in local switching units that interface with a North Electric TSD for handling of Automatic Message Accounting (AMA) and operator assisted calls.

The following table lists the multifrequency (MF) start signal and category code associated with each of the following call identifiers.

#### Ca II identifiers

Call identifier	Value
Automatic Time and Charges0-0+1+	ATCZMATCZPATCP
Coin0-0+1+	CNZMCNZPCNP
Denied Toll0-0+1+	DTZMDTZPDTP
Hotel or Motel 0-0+1+	HTLZMHTLZPHTLP
Marine or Mobile Telephone0-0+1+	IMTSZM IMTSZP IMTSP
Non-Coin0-0-, ONI0-, ANI Failure0+0+, ONI0+, ANI Failure1+1+, ONI1+, ANI Failure	NCZMNCZMONINCZMFLNCZPNCZP ONINCZPFLNCPNCPONINCPFL
<b>Note 1:</b> ANI (automatic number identification)	
<b>Note 2:</b> ONI (operator number identification)	
Special0-0+1+	SPZMSPZPSPP
WATS0-0+1+	WATZMWATZPWATSP
<b>Note:</b> WATS (wide area telephone service)	

For each of the call identifiers, specify one of the following MF start signals: NO, KP, ST, STP, ST2P, or ST3P.

Specify the category code associated with the call identifier.

**CATCODES** (continued)**Datafill sequence and implications**

There is no requirement to datafill other tables prior to table CATCODES.

**Table size**

0 to 35 tuples

**Datafill**

The following table lists datafill for table CATCODES.

**Field descriptions (Sheet 1 of 2)**

Field	Subfield or refinement	Entry	Explanation and action
CATKEYS		ATCZM, ATCZP, ATCP, CNZM, CNZP, CNP, DTZM, DTZP, DTP, HTLZM, HTLZP, HTLP, IMTSZM, IMTSZP, IMTSP, NCZM, NCZMONI, NCZMFL, NCZP, NCZPONI, NCZPFL, NCP, NCPONI, NCPFL, SPZM, SPZP, SPP, TS, WATSZM, WATSZP,orW ATSP	<i>Category key</i> Enter the call type identifier that is assigned to the entry. See table Table , "Ca ll identifiers" on page -878 for a brief explanation of the entries.

**CATCODES** (end)

**Field descriptions (Sheet 2 of 2)**

Field	Subfield or refinement	Entry	Explanation and action
STDIGS		NO, KP, ST, STP, ST2, or ST3P	<i>Start digits</i> Enter the multifrequency start signal associated with the call type identifier.
DR		00 to 999	<i>Digit register</i> Enter the two- or three-digit category code associated with the call type identifier.  Entries outside this range are invalid.

**Datafill example**

The following example shows sample datafill for table CATCODES.

**MAP display example for table CATCODES**

CATKEYS	STDIG	DR
NCZM	ST	050
ATCZM	ST	051
NCZPONI	STP	256
NCZPFL	ST2P	256

---

**CCANFMT**

---

**Table name**

Calling Card Account Format Table

**Functional description**

Table CCANFMT defines correct calling card number strings and correct card number lengths. Table CCANFMT is a digilator table. Enter the most important digits on the calling card number in this table. The default for this table is to allow 12-digit card numbers.

The calling card format is MXXXXXXXXPPPP.

*where:*

**M**

is the state identifier, values 2 to 7

**X**

is the account number digits, values 0 to 9

**P**

is the personal identification number (PIN) digits, values 0 to 9

The earlier group provides a 12-digit calling card number.

For calling card accounts (CCAN) that table CCANFMT does not contain, the minimum and maximum number of digits defaults to 12.

Deletion of tuples from table CCANFMT deletes the range of tuples that field KEY specifies.

**Datafill sequence and meaning**

You do not need to enter data in other tables before you enter data in table CCANFMT.

**Table size**

0 to 32 767 tuples

The maximum table size depends on the number of digits required to specify the key for each entry in the table. A total of 32 767 digilator blocks are available to this table. Each digit in each part of the key requires one digilator block.

**CCANFMT** (continued)**Datafill**

The datafill for table CCANFMT appears in the following table.

**Field descriptions**

<b>Field</b>	<b>Subfield or refinement</b>	<b>Entry</b>	<b>Description</b>
KEY		see subfields	<p><i>Key.</i> This field is the key to the table. This field contains subfields FROMCCAN and TOCCAN.</p> <p><b>Note:</b> The CCANs that begin with 0 to 233, or 236 to 9, must be 9 to 18 digits in length. These CCANS include the personal identification number (PIN). The CCANs that begin with 234 or 235 must be 12 digits in length. These CCANS include the PIN.</p>
	FROMCCAN	0 to 9 (1 to 18 digits)	<i>From calling card account.</i> Enter the important digits for the lower limit of the permitted calling card account numbers (CCAN).
	TOCCAN	0 to 9 (1 to 18 digits)	<i>To calling card account.</i> Enter the important digits for the upper limit of the permitted calling card account numbers.
	MINDIG	0 to 9 (5 to 23 digits)	<i>Minimum digits.</i> Enter the minimum number of digits required for a correct CCAN/PIN entry. The system requires a minimum of five CCAN digits to access the information in table CCANFMT.
	MAXDIG	0 to 9 (5 to 23 digits)	<i>Maximum digits.</i> Enter the maximum number of digits that you can enter for a CCAN/PIN. The value that you enter for MAXDIG must be greater than or equal to the MINDIG value. The system requires a minimum of five CCAN digits to access the information in table CCANFMT.

**Datafill example**

Sample datafill for table CCANFMT appears in the following example.

---

**CCANFMT** (end)

---

**MAP example for table CCANFMT**

	KEY	MINDIG	MAXDIG
	0	233	9 18

**Table history****BCS36**

Field KEY was added in BCS36. Fields FROMCCAN and TOCCANN became subfields of field KEY.

# CCC

## Table name

Central Control Complex Assignment Table

## Functional description

The following assignment data for the central control complex (CCC) appear in table CCC:

- floor, row on floor, and frame position in row of each plane of the CCC
- frame type and number on which the CCC complex is physically mounted
- central message controller (CMC) or central message and input/output device controller (MDC) and CPU or central processing and memory shelf positions and product engineering code (PEC)
- type of data store bus (balanced or unbalanced)

For a cabinetized Meridian SL-100, the meridian cabinet core module (MCCM) is the frame type.

Descriptions of the CMC and CPU PEC, with the correct references from the *DMS-100 Provisioning Manual*, 297-1001-450, appear in the following table.

### CCC CMC and CPU PECs (Sheet 1 of 2)

PEC	Description	Reference
2X76AA	Central MSG & I/O DEV controller	EMR4-05-000
2X76AB	Central MSG & I/O DEV controller	EMR4-07-000
2X7606	CM & I/O Device CTL SH ASSY	EMR4-10-000
1X32AA	Central MSG controller	EMR4-01-000
1X32AB	Central MSG controller	EMR4-03-000
1X41AA	Central processing unit	EMR4-01-000
1X41AB	Central processing unit	EMR4-03-000
3X41AA	Central proc & MEM module	EMR4-05-000
3X41BA	Central proc & MEM module	EMR4-07-000
3X41DA	Central proc & MEM module	EMR4-09-000
3X4106	Central proc & MEM shelf assy	EMR4-10-000

**CCC** (continued)**CCC CMC and CPU PECs (Sheet 2 of 2)**

PEC	Description	Reference
7X28AA	Special DMS-100 project	Not available
7X31AA	Special DMS-100 project	Not available
7X3102	Special DMS-100 project	Not available
MX4501	DS memory/MCM/clock assy	EMA10-18-000

**Datafill sequence and meaning**

You do not need to enter data in other tables before you enter data in table CCC.

**Table size**

The system allocates memory for planes 0 and 1 of the CCC.

**Datafill**

The datafill for table CCC appears in the following table.

**Field descriptions (Sheet 1 of 2)**

Field	Subfield or refinement	Entry	Description
PLANE		0 to 1	<i>Plane.</i> Enter the plane number of the central control complex (CCC).
FRTYPE		CCC, MCCM, or MCOR	<i>Frame type.</i> Enter one of the following frame types on which equipment is mounted. <ul style="list-style-type: none"> <li>• CCC (central control complex)</li> <li>• MCCM (Meridian cabinet core module)</li> <li>• MCOR (Meridian core module)</li> </ul>
FRNO		0	<i>Frame number.</i> Enter the frame number of the CCC frame on which the equipment is mounted.  An entry out of this range is not correct.



**CCC** (continued)**Field descriptions (Sheet 2 of 2)**

<b>Field</b>	<b>Subfield or refinement</b>	<b>Entry</b>	<b>Description</b>
CMCSHPOS		65	<i>CMC or MDC shelf position.</i> Enter the shelf position of the central message controller (CMC) or the central message and I/O device controller (MDC) on the CCC frame.  An entry that is not in this range is not correct.
CPUSHPOS		51	<i>CPU or CPM shelf position.</i> Enter the shelf position of the CPU or the central processor and memory unit (CPM) on the CCC frame.  An entry that is not in this range is not correct.
FLOOR		0 to 99	<i>Floor.</i> Enter the floor or the remote location number - the location of the equipment.
ROW		A to Z AA to ZZ, except I, II, O, OO	<i>Row.</i> Enter the row on the floor that contains the CCC frame.
FRPOS		0 to 99	<i>Frame position.</i> Enter the bay position number in the row that contains the frame.
CMCPEC		1X32AA 1X32AB 2X76AA 2X76BA 7X28AA 2X7606 MX4501	<i>CMC or MDC product engineering code.</i> Enter the PEC of the CMC, MDC, the combined data store (DS)/CMC/IOC shelf, or the MCOR.
CPUPEC		1X41AA 1X41AB 3X41AA 3X41BA 3X41DA 3X41EA 7X31AA 3X4106 7X3102	<i>CMC or CPM product engineering code.</i> Enter the PEC of the CPU, the CPM or the combined program store (PS)/CPU shelf.
DSBUS		BALANCED or UNBAL- ANCED	<i>Data store.</i> Enter the type of data store bus, balanced or unbalanced.

## Datafill example

Sample datafill for table CCC appears in the following example.

The assignments that associate with CCC 0, plane 0 and 1 appear in the following example. One record is available for each plane of the CCC.

## MAP example for table CCC

PLANE	FRTYPE	FRNO	CMCSHPOS	CPUSHPOS	FLOOR	ROW	FRPOS	CMCPEC	CPUPEC	DSBU
0	CCC	0	65	51	0	A	2	1X32AB	1X41AB	BALANCED
1	CCC	1	65	51	0	A	3	1X32AB	1X41AB	BALANCED

# CCCSOPTS

## Table name

Calling card carrier select options

## Functional description

Table CCCSOPTS specifies outpulsing for calling card (CC) calls when selecting a carrier. This table is accessed with the TERMZONE (from table TERDIGS) and CC issuer ID.

## Datafill sequence and implications

There is no requirement to datafill other tables prior to table CCCSOPTS.

## Table size

0 to 10,000 tuples

## Datafill

The following table lists datafill for table CCCSOPTS.

### Field descriptions (Sheet 1 of 3)

Field	Subfield or refinement	Entry	Explanation and action
TERMZONE		name from table TOPSZONE	Terminating zone. This field is part of the key to the table. Enter a terminating zone name defined in table TOPSZONE. The name in table TOPSZONE must be associated with an INDEX in the range 0 to 256. A name with an index outside this range results in an error message..
ISSUERID		4 to 7 digits	CC issuer identification number. This field is part of the key to the table. Table CCGRPING may be used to map a range of IDs to a group ID, but is not necessary. If table CCGRPING is not used, the operator entered CC issuer ID is used to index this field.
CCCSOPTS		see subfield	Calling Card Carrier Select Options. This field consists of subfield CCCSOPTS

**CCCSOPTS** (continued)

## Field descriptions (Sheet 2 of 3)

Field	Subfield or refinement	Entry	Explanation and action
	CCCSOPTS	ALLOW, BLOCK, or SUBST (1-8 digits, 1-100 weighted distribution value)	<p>Country direct carrier select options. This field indicates handling of the call. The values are:</p> <ul style="list-style-type: none"> <li>• ALLOW - Outpulse the existing translations: network prefix + country code + national number. Note that there is no carrier code, so the following network (international gateway) needs to perform translations to select the carrier.</li> </ul> <p>Note: If a call is outpulsed from the TOPS switch with digits which are invalid for a carrier to the next network, that is DMS-300, then the next network must apply its own translations to select the outgoing carrier. This applies to calls which are treated with the ALLOW option and treated with the SUBST option with an invalid digit string.</p> <ul style="list-style-type: none"> <li>• BLOCK - Disallow outpulsing. A display is presented on the operator screen.</li> <li>• SUBST - Replace the network prefix and country code as determined by translation tables CCTR and CTCODE. Datafill refinement VECTOR.</li> </ul> <p>The note under the ALLOW option is also applicable to this SUBST option.</p>
	VECTOR	see subfields	<p>Vector. This refinement is valid only when field CCCSOPTS = SUBST. This refinement consists of subfields DIGITS and WEIGHT. Up to 16 iterations of this refinement can be entered.</p>

**CCCSOPTS** (continued)

## Field descriptions (Sheet 3 of 3)

Field	Subfield or refinement	Entry	Explanation and action
	DIGITS	1 to 8 digits	Digits for substitution - This user defined value replaces the network prefix and country code. This value may contain a routing prefix, carrier code, service code, and so forth. The national number remains intact at all times. Thus, the substitution string and called national number are outpulsed. The substitution string plus national number must be 18 digits or less; otherwise, the national number is truncated and the call does not complete.
	WEIGHT	1 to 100	Weighted distribution value - The SUBST option randomly selects the substitution string (field DIGITS) based upon this weighted value. The higher the weight, the more often the substitution string is used. All iterations of this weighted value in this tuple must add up to 100.

**Datafill example**

The following example shows sample datafill for table CCCSOPTS.

**MAP display example for table CCCSOPTS**

TERMZONE	ISSUERID	CCCSOPTS
CARIBBEAN	5417	ALLOW
CARIBBEAN	891444	BLOCK
BARBADOS	8911	SUBST (092611 100)\$

**Table history**  
**TOPS12**

Restriction added to field TERMZONE about the range in table TOPSZONE. This change is made by feature A59006827 in functionality Table LATANAME Expansion, OSB00001.

Even though design activities related to the feature LATA Screening Alternative modified CCCSOPTS, this feature does not use this table to function.

**CCCSOPTS** (end)

---

**TOPS08.1**

This table was created by feature AF7021 in functionality Carrier Selection, ENSV0001.

## CCDGTAN

---

### Table name

Country Code Digit Analyzer Table

### Functional description

Table CCDGTAN provides extended multiprocessor system (XMS)-based peripheral module (XPM) digit analysis for the multifrequency compelled (MFC) CCITT signaling system R2 (MFC-R2) protocol. The entry of data in this table can improve the quality of register signaling through digit analysis in the XPM. Digit analysis saves protocol time and reduces central control (CC) to XPM messages. The DMS-300, and international DMS-100/200 switches that support R2 signaling, contain this table.

To support end-to-end protocol, the system must support some digits before in-pulsing ends. The system must send some digits in this first-digits message to the XPM. Table CCDGTAN defines this digit analysis for country codes and functions as a look-up table for the information.

### Datafill sequence and meaning

You must enter data in other tables before you enter data in table CCDGTAN.

### Table size

0 to 60 tuples

### Datafill

The datafill for table CCDGTAN appears in the following table.

#### Field descriptions (Sheet 1 of 2)

Field	Subfield or refinement	Entry	Description
INDEX		0 to 63	<i>Table index.</i> Enter the table index value.
CODE		0 to 9 and B to F (a maximum of 4 digits)	<i>Country code.</i> Enter the country code. You can enter false country codes.

**CCDGTAN** (continued)**Field descriptions (Sheet 2 of 2)**

Field	Subfield or refinement	Entry	Description
MINDIGS		0 to 24	<i>Minimum digits.</i> Enter the number of non-optional digits where the system requires every digit for the first message. The system uses a shorter inter-digit time-out when the minimum digits value is met.
MAXDIGS		0 to 24	<i>Maximum digits.</i> Enter the maximum number of digits that the system requires for the first message. If the system requires every digit, enter the maximum expected number. If you include the optional digits in the maximum number, you can improve the MFC protocol. You save the protocol through the preservation of the end-of-digit signal and the removal of time-outs.

**Datafill example**

Sample datafill for table CCDGTAN appears in the following example.

This example contains three tuples. The first tuple reports the country code. The second and third tuple report the digits that the system requires to end in-pulsing. The third tuple reports 2 optional digits. Entry of optional digits shortens time-outs.

**MAP example for table CCDGTAN**

INDEX	CODE	MINDIGS	MAXDIGS
1	44	2	2
2	1	11	11
3	972	9	11

**Table history****BCS34**

Table CCDGTAN was introduced in BCS34.

**Additional information**

The system downloads datafill in table CCDGTAN to XPMs during a system or manual return to service (RTS). The system downloads the datafill as part



**CCDGTAN** (end)

---

of the static data. Changes to the datafill in table CCDGTAN do not occur in the XPM until the RTS is complete.

**Table name**

Central Control Inventory Table

**Functional description**

Feature Remote Maintenance and Control provides Central Control Maintenance support for the remote maintenance and control hardware. This hardware is part of the NT1X48CA (DAct, reset and thumbwheel) card on the central processing unit (CPU). This hardware becomes available when operating company personnel configure the office for this feature.

The hardware contains a microprocessor, registers and relays, and a serial interface. The hardware provides remote access to the face plate controls that are on the NT1X48CA card. The hardware also monitors alarms and NT1X48CA card status lights (offline, hex, and activity).

To allow the Remote Maintenance and Control (RMC) function of the NT1X48CA card, enter NT1X42AA (E2ATelemetry Serial Interface CP card) in this table.

The tuple for the NT1X48CA card in table CCIN identifies the CC maintenance software and the RMC feature on the DMS switch. The tuple identifies the CC maintenance software and the RMC feature under two conditions. Operating company personnel must fit the ESI CP card (NT1X42AA) in slot 13. Operating company personnel must also fit the NT1X48CA card in a slot between 0 to 27 (except 13). If you do not enter NT1X48CA in this table, the system assumes that the switch does not have the hardware for RMC.

**Datafill sequence and meaning**

You do not need to enter data in other tables before you enter data in table CCIN.

**Table size**

27 tuples

---

## CCIN (end)

---

### Datafill

The datafill for table CCIN appears in the following table.

#### Field descriptions

Field	Subfield or refinement	Entry	Description
SLOTNO		0 to 27	<i>Slot number.</i> Enter the slot number of the specified CARDPEC.
CARDPEC		alphanumeric	<i>Card product engineering code (PEC).</i> Enter a correctcard PEC that corresponds to a NT1X48 card. The system rejects other PECs.

### Datafill example

Sample datafill for table CCIN appears in the following example.

To allow the RMC feature of the NT1X48CA card, card NT1X42AA must fit in slot 13 and be entered in field CARDPEC.

*Note:* The entry of the 1X48CA tuple can occur in a slot between 0 to 27, except 13.

#### MAP display example for table CCIN

SLOTNO	CARDPEC
13	1X42AA
1	1X48AC

---

**CCLIST**

---

**Table name**

Country Code List Table

**Functional description**

The system uses table CCLIST to determine the number of digits in a given country code or pseudo country code. The DMS-300 switching unit receives the digits in the digit stream. The DMS-300 switching unit uses the digits for signaling systems CCITT # 5, ATUP (Austrian telephone user part), and T3MFC (multifrequency compelled).

If a language or discrimination digit is present in the digit stream, the system accesses table CCLIST. The system uses the incoming digit stream that starts with the country code to access the table. The system accesses the table to determine the number of country code digits. If the signaling system is ATUP or T3MFC, call processing uses the length of the country code to remove digits. Call processing removes the language or discrimination digit from the digit stream. Call processing stores the length of the country code for later use.

For signaling CCITT # 5, the system records the language or discrimination digit. The system does not remove the digit from the digit stream. The language or discrimination digit can be present in the digit stream for signaling systems ATUP or T3MFC. The system removes the language or discrimination digit before the system accesses table INPRTRNS. The two signaling systems can receive a language or discrimination digit that has a value from 0 to F. The system must use values of 0 to 9, B, and C to access table INPRTRNS.

*Note:* The DMS-300 customers must enter data in table CCLIST. The DMS-300 customers must enter every country code and pseudo country code that the DMS-300 switching unit can receive.

**Datafill sequence and meaning**

You do not need to enter data in other tables before you enter data in table CCLIST.

**Table size**

The number of country codes in use determines the size of table CCLIST.

---

## CCLIST (end)

---

### Datafill

The datafill for table CCLIST appears in the following table.

#### Field descriptions

Field	Subfield or refinement	Entry	Description
COUNTRY		0 to 9 (1 to 18 digits)	<i>Country code.</i> Enter each country code that the DMS-300 switching unit can receive in a digit stream. The country code can be a true or pseudo country code.
CTRYNAME		alphanumeric (a maximum of 8 characters)	<i>Country name.</i> Enter the country name of the country code. If the country name is longer than 8 characters, use an abbreviated country name.  This field is for information purposes.

### Datafill example

Sample datafill for table CCLIST appears in the following example.

#### MAP display example for table CCLIST

COUNTRY	CTRYNAME
1	USA

### Table history

#### BCS36

The entry in field COUNTRY expanded from 1 to 4 digits to 1 to 18 digits in BCS36.

---

**CCNAMES**

---

**Table name**

Country Code Translation Names Table

**Functional description**

Table CCNAMES maps country code translation names to table CCTRNSL.

**Limits**

Observe the following limits when you enter data in table CCNAMES:

- Reserve entry 0 (zero) in field VALUE for the nil translator. Reserve the entry for the value NCTR (no country code translator) in field SYMBOL.
- You can use entries 1 to 31 in field VALUE in table CCTRNSL for tuples that the Gateway Network Management Code Control (INTCCTRL) feature can control.
- You can use entries greater than 31 in field VALUE in table CCTRNSL for translations not subject to INTCCTRL.
- You can enter a maximum of four character in field SYMBOL to match the entries in field CCTRNM in table CCTRNSL.

**Datafill sequence and meaning**

You do not need to enter data in other tables before you enter data in table CCNAMES.

**Table size**

0 to 255 tuples

**CCNAMES** (continued)

---

**Datafill**

Datafill for table CCNAMES appears in the following table.

**Field descriptions**

Field	Subfield or refinement	Entry	Explanation and action
VALUE		0 to 32 767	<p><i>Value.</i> Enter an unsigned integer for each entry in field SYMBOL.</p> <p>Enter 0 (zero) if the entry in field SYMBOL is NCTR.</p> <p>You can use entries from 1 to 31 in table CCTRNSL for tuples that feature INTCCTRL can control.</p> <p>You can use entries greater than 31 in table CCTRNSL for translations not subject to feature INTCCTRL.</p>
SYMBOL		alphanumeric (a maximum of 4 characters)	<p><i>Country code translation name.</i> Enter the country code translation name that the operating company defines. Entries out of the range specified for this field are not correct.</p>

**Datafill example**

Sample datafill for table CCNAMES appears in the following example.

---

**CCNAMES** (end)

---

**MAP display example for table CCNAMES**

VALUE	SYMBOL
0	NCTR
1	CC00
2	CC01
3	CC02
4	CC03
5	CC04
6	CC05
8	CC06
9	CC07
10	CC08
11	CC10
12	CC20
13	CC54



## CCS7PPLN

---

### Table name

The CCS7 Preplan Control Table

### Functional description

Dynamic overload control is a network management system. The dynamic overload control handles heavy traffic during overload conditions. The congested switch alerts connecting switches of the different levels of congestion. The congested switch transmits congestion level signals through CCS7 to alert the connecting switches.

Table CCS7PPLN contains the far-end routeset of the point code that triggers dynamic overload control (DOC) levels 1, 2, and 3. Each entry in table CCS7PPLN contains a preplan number for the three DOC levels.

The preplan number indexes into table PREPLANS to get the correct overload controls to apply.

### Datafill sequence and meaning

You must enter data in table C7RTESET before you enter data in table CCS7PPLN.

### Table size

0 to 63 tuples

The tuple size is 5 bytes.

### Datafill

Datafill for table CCS7PPLN appears in the following table.

### Field descriptions

Field	Subfield or refinement	Entry	Explanation and action
PCNAME		alphanumeric (1 to 16 characters)	<i>Point code name.</i> Enter the name of a point code routeset entered earlier in table C7RTESET.
PPLNNO		3 entries, each with a value from 0 to 255	<i>Preplan number.</i> Specifies the machine congestion preplan number. Enter the preplan number for congestion number 1, 2 and 3.

---

**CCS7PPLN** (end)

---

**Datafill example**

Sample datafill for table CCS7PPLN appears in the following example.

**MAP example for table CCS7PPLN**

PCNAME		PPLNNO	
C7RTESET1	1	2	4
C7RTESET2	1	3	4

## **CCSALARM**

---

### **Table name**

Common Channel Signaling Alarm Table

### **Functional description**

Table CCSALARM allows operating company personnel to modify the order of common channel signaling (CCS) alarms for each severity level. Operating company personnel modify an entry in this table to modify the order of CCS alarms. The first entry in the table becomes the top level alarm display at the MAP terminal. This event occurs if a difference in the alarm type occurs when more than one CCS system is present on the switch.

This table does not allow operating company personnel to modify the order of alarms associated with Auto Imaging. The Auto Imaging Critical Alarm (IMGC) is the lowest priority CCS7 critical alarm. The Auto Imaging Major Alarm (IMGMA) is the lowest priority CCS7 major alarm.

### **Datfill sequence and meaning**

You do not need to enter data in other tables before you enter data in table CCSALARM.

### **Table size**

24 tuples (fixed)

**CCSALARM** (continued)**Datafill**

Datafill for table CCSALARM appears in the following table.

**Field descriptions (Sheet 1 of 2)**

<b>Field</b>	<b>Subfield or refinement</b>	<b>Entry</b>	<b>Explanation and action</b>
ALARMKEY		0 to 23	<p><i>Alarm key</i></p> <p>This field is the key to the table. Enter numbers in this field in increasing order. For example, use an entry of 0 before an entry of 1. When numbering gaps in the table appear because of the deletion of entries, use the lowest available number. The lowest value in field ALARMKEY determines which alarms have priority. The lowest value determines which alarms have the lowest priority when a conflict in the top-level alarm display is present.</p>
ALARMS		see subfields	<p><i>Alarm information area</i></p> <p>This field contains subfields CCSTYPE and SEVERITY.</p>

**CCSALARM** (continued)

Field descriptions (Sheet 2 of 2)

Field	Subfield or refinement	Entry	Explanation and action
	CCSTYPE	alphanumeric CCS7, CCIS6, CCITT6, DPNSS, or V5	<p><i>Common channel signaling type</i></p> <p>Enter the type of common channel signaling (CCS) to which this alarm ordering applies. Only enter data when if you must change the current ordering. You can enter a maximum of three entries for each CCS type. Enter one data entry for each alarm severity.</p> <p>Enter the CCS type as follows:</p> <ul style="list-style-type: none"> <li>• Enter CCS7 for Common Channel Signaling 7 and enter data in refinement ALARMSET on page Section , "CCSTYPE = CCS7" on page -907.</li> <li>• Enter CCIS6 for Common Channel Interoffice Signaling No. 6 and enter data in refinement ALARMSET in section "CCSTYPE = CCIS6, CCITT6 or DPNSS".</li> <li>• Enter CCITT6 for CCITT No. 6 Signaling and enter data in refinement ALARMSET in section "CCSTYPE = CCIS6, CCITT6, or DPNSS".</li> <li>• Enter DPNSS for Digital Private Network Signaling System and enter data in refinement ALARMSET in section "CCSTYPE = CCIS6, CCITT6, or DPNSS".</li> <li>• Enter V5 for V5.2 and enter data in refinement ALARMSET.</li> </ul>
	SEVERITY	CRITICAL MAJOR or MINOR	<p><i>Alarm severity</i></p> <p>Enter the alarm severity to order. Two table entries cannot have the same combination of CCS type and alarm severity.</p>

**CCSALARM** (continued)**CCSTYPE = CCS7**

The following table describes datafilling refinement ALARNSET when the entry in subfield CCSTYPE is CCS7.

**Field descriptions for conditional datafill (Sheet 1 of 2)**

Field	Subfield or refinement	Entry	Explanation and action
	ALARMSET	(vector of a maximum of 5) LKSET, LM, LSS, PC, RSS, RTESET, or SEAS	<p><i>CCS top level alarm set order</i></p> <p>If the entry in subfield SEVERITY is CRITICAL, enter a vector of four elements. This vector must contain local subsystem (LSS), point code (PC), remote subsystem (RSS) and routeset (RTESET). Enter the vector in the order in which the operating company requires the CCS critical alarms to appear. Separate entries with a space.</p> <p>If the entry in subfield SEVERITY is MAJOR, enter a vector of three elements that contains linkset (LKSET), LSS and RTESET. Enter the vector in the order in which the operating company requires the CCS major alarms to appear. Separate entries with a space.</p>

## CCSALARM (continued)

### Field descriptions for conditional datafill (Sheet 2 of 2)

Field	Subfield or refinement	Entry	Explanation and action
			<p>If the entry in subfield SEVERITY is MINOR, enter a vector of five elements. This vector must contain LKSET, link minor (LM), PC, RTESET, and Signaling, Engineering, and Administration System (SEAS). Enter the vector in the order in which the operating company requires the CCS minor alarms to appear. You can only enter the SEAS or LM alarms if SEAS or signaling link marginal performance report (SLMPR) is on the switch. Separate entries with a space.</p> <p><b>Note 1:</b> Enter the correct number of alarms. Base this number on the CCS system and the optional packages present on the node. The system notifies operating company personnel if you enter the wrong number of alarms. The system notifies operating company personnel if the alarm entered cannot be entered.</p> <p><b>Note 2:</b> This table does not allow operating company personnel to modify the order of alarms associated with Auto Imaging. The Auto Imaging Critical Alarm (IMGC) is the lowest priority CCS7 critical alarm. The Auto Imaging Major Alarm (IMGM) is the lowest priority CCS7 major alarm.</p>

### CCSTYPE = CCIS6, CCITT6, or DPNSS

If the entry in subfield CCSTYPE is CCIS6, CCITT6, or DPNSS enter data in refinement ALARMSET. The following table describes datafilling refinement

**CCSALARM** (continued)

ALARMSET when the entry in subfield CCSTYPE is CCIS6, CCITT6 or DPNSS.

**Field descriptions for conditional datafill**

Field	Subfield or refinement	Entry	Explanation and action
	ALARMSET	(vector of a maximum of 2) LKSET or RTESET	<p><i>CCS top level alarm set order</i></p> <p>If the entry in subfield SEVERITY is CRITICAL, enter a vector of two elements that contain linkset (LKSET) and routeset (RTESET). Enter the vector in the order that the operating company requires the CCS critical alarms to appear. Separate each entry with a blank space.</p> <p>If the entry in subfield SEVERITY is MAJOR, enter a vector of two elements that contain LKSET and RTESET. Enter the vector in the order that the operating company requires the CCS major alarms to appear. Separate each entry with a blank space.</p> <p>If the entry in subfield SEVERITY is MINOR, enter a vector of two elements that contain LKSET and RTESET. Enter the vector in the order that the operating company requires the CCS minor alarms to appear. Separate each entry with a blank space.</p> <p><b>Note:</b> Enter the correct number of alarms. Base this number on the CCS system and the optional packages on the node. The system notifies you if you enter the wrong number of alarms. The system notifies you if the alarm you enter cannot be datafilled.</p>



**CCSALARM** (continued)**CCSTYPE = V5**

If the entry in subfield CCSTYPE is V5, enter data in refinement ALARMSET. The following table describes datafilling refinement ALARMSET when the entry in subfield CCSTYPE is V5.

**Field descriptions for conditional datafill**

Field	Subfield or refinement	Entry	Explanation and action
	ALARMSET	(vector of a maximum of 6) CCHNL, ISDD, PSTN, V5I, V5LK, or V5LKM	<p><i>CCS top level alarm set order</i></p> <p>If the entry in the SEVERITY subfield is CRITICAL, enter a vector of three elements that contain V5 interface (V5I), public switched telephone network (PSTN), and ISDN D (ISDD). Enter the vector in the order that the operating company requires the CCS critical alarms to appear. Separate each entry with a blank space.</p> <p>If the entry in subfield SEVERITY is MAJOR, enter a vector of two elements that contains V5 link major (V5LKM) and C-Channel carrying control channel (CCHNL). Enter the vector in the order that the operating company requires the CCS major alarms to appear. Separate each entry with a blank space.</p> <p>If the entry in subfield SEVERITY is MINOR, enter a vector of one element that contains V5 link (V5LK). Enter the vector in the order that the operating company requires the CCS minor alarms to appear. Separate each entry with a blank space.</p> <p><b>Note:</b> Enter the correct number of alarms. Base this number on the CCS system and the optional packages on the node. The system notifies you if you enter the wrong number of alarms. The system notifies you if the alarm you enter cannot be datafilled.</p>

**Datafill example**

Sample datafill for table CCSALARM appears in the following example.

The following example contains a switching unit with one Common Channel Signaling 7 (CCS7) system.

**CCSALARM** (end)

The order of critical alarms is local subsystem, routeset, point code, and remote subsystem.

The order of major alarms is linkset, routeset, and local subsystem.

The order of minor alarms is point code, link minor, SEAS, linkset, and routeset.

**MAP display example for table CCSALARM**

ALARMKEY	ALARMS		
0	CCS7	CRITICAL	LSS RTESET PC RSS
1	CCS7	MAJOR	LKSET RTESET LSS
2	CCS7	MINOR	PC LM SEAS LKSET RTESET

# CCSDOC

## Table name

The CCS Selective Dynamic Overload Control table

## Functional description

Table CCSDOC contains control for the trunk groups that receive CCS dynamic overload control (DOC) signals. Table CCSDOC entries contain three references to controls. Table PREPLANS stores these controls. Table CCSDOC entries contain one reference each for DOC levels 1, 2 and 3.

Each reference contains a preplan number and a control number in the specified preplan.

The short CLLI entry in table CCSDOC must match the short CLLI of the preplan control in table PREPLANS.

## Datafill sequence and meaning

You must enter data in table NWPPLN before you enter data in table CCSDOC.

*Note:* You can only enter data in table CCSDOC when the value of CCS field in table NWPPLN is Y (yes).

## Datafill

Datafill for table CCSDOC appears in the following table.

### Field descriptions (Sheet 1 of 2)

Field	Subfield or refinement	Entry	Explanation and action
SCLLI		alphanumeric (a maximum of 6 characters)	<i>Short common language location identifier.</i> Enter the short CLLI of the trunk group to which the SDOC controls apply.
CONTROL1		see subfields	<i>Control one.</i> This field contains subfields PPLNO and PPLNCTRL.
	PPLNO	0 to 255	<i>Preplan number.</i> Enter the preplan number of the preplan that contains the related control.

## Field descriptions (Sheet 2 of 2)

Field	Subfield or refinement	Entry	Explanation and action
CONTROL2	PPLNCTRL	0 to 31	<i>Preplan control number.</i> Enter the preplan control number of the related control.
		see subfields	<i>Control two.</i> This field contains subfields PPLNO and PPLNCTRL.
CONTROL3	PPLNO	0 to 255	<i>Preplan number.</i> Enter the preplan number of the preplan that contains the related control.
	PPLNCTRL	0 to 31	<i>Preplan control number.</i> Enter the preplan control number of the related control.
		see subfields	<i>Control three.</i> This field contains subfields PPLNO and PPLNCTRL.
	PPLNO	0 to 255	<i>Preplan number.</i> Enter the preplan number of the preplan that contains the related control.
	PPLNCTRL	0 to 31	<i>Preplan control number.</i> Enter the preplan control number of the related control.

## Datafill example

Datafill for table CCSDOC appears in the following example. The preplan assignments for three CCIS outgoing trunks appear in this example.

## MAP display example for table CCSDOC

SCLLI	CONTROL1		CONTROL2		CONTROL3	
CCS3A	1	0	1	1	1	2
CCS4A	2	3	2	4	2	5
CCS5A	1	3	1	4	1	5

## CCTR

---

### Table name

Country Code table

### Functional description

Local, toll or combined local/toll switching units for direct dial overseas routing require table CCTR.

The system automatically provides memory for all country codes. The system routes all country codes not specified to vacant code treatment.

Translation enters table CCTR if the standard pretranslator specifies international for the prefix digits that the user dials. The standard pretranslator specifies international when the translation system is equal to IN. An example of a prefix digit is 011.

### Datafill sequence and meaning

You do not need to enter data in other tables before you enter data in table CCTR.

### Datafill

Datafill for table CCTR appears in the following table.

The following warning applies to field MAXDIGSR:



#### **WARNING**

**If number of digits exceeds the maximum, a serious consequence can occur**

The maximum number of country code plus national important digits is 15. If you set the field MAXDIGSR greater than 15, serious consequences can occur.

**CCTR** (continued)**Field descriptions (Sheet 1 of 2)**

<b>Field</b>	<b>Subfield or refinement</b>	<b>Entry</b>	<b>Explanation and action</b>
CCNAME		alphanumeric (a maximum of 18 digits)	<i>Country code</i> Enter a country code.
GIVENCC		see subfields	<i>Given country code.</i> This field contains subfield CCSEL and refinement PCC.
	CCSEL	T or P	<i>Country code selector.</i> Enter T if the code is a true country code and enter data in refinement PCC.  If the code is not a true country code, enter P for a pseudo country code. No refinements require datafill. Go to field MINDIGSR.
	PCC	alphanumeric (a maximum of 18 digits)	<i>Pseudo country code.</i> If field CCSEL is set to T and the switching unit is toll or combined local/toll, enter a pseudo country code.  If the switching unit is local, enter N.
MINDIGSR		0 to 18	<i>Minimum digits required.</i> Enter the minimum number of digits required. These digits must include the country code.
MAXDIGSR		0 to 25	<i>Maximum digits required.</i> Enter the maximum number of digits required. These digits must include the country code.  Entries out of this range are not correct.
TMTORRTE		see subfields	<i>Treatment or route reference.</i> This field contains subfield TRSEL.
	TRSEL	T or D	<i>Treatment or route selector.</i> Enter D if translation routes to a treatment and enter data in refinement TREAT.  Enter T if translation routes to office route table and enter data in refinement TUPID.

**CCTR** (continued)**Field descriptions (Sheet 2 of 2)**

Field	Subfield or refinement	Entry	Explanation and action
	TREAT	alphabetic (a maximum of 4 characters)	<i>Treatment.</i> If the entry in subfield TRSEL is D, enter the treatment to which translation routes.
	TUPID	see subfields	<i>Treatment or route reference.</i> If the entry in subfield TRSEL is T, enter data in this refinement. This field contains subfields TABID and KEY.
	TABID	OFRT	<i>Table name.</i> Enter OFRT for office route table.  Entries out of this value are not correct.
	KEY	1 to 1023	<i>Index.</i> Enter the index into the office route table to which translation routes.  Entries out of this range are not correct.
CUSTDIAL		N or Y	<i>Customer dialed.</i> Enter Y (yes) if the customer can dial the code. If the customer must not dial the code, enter N (no).  If the call originates from a local source and field CUSTDIAL is N, the system routes the originator to reorder treatment RODR. Examples of local sources are line, incoming CAMA trunk, or local trunk with local source of origination.

**Datafill example**

Sample datafill for table CCTR appears in the following example.

The example contains one assigned true country code (44) and one vacant pseudo country code (057).

**CCTR** (end)**MAP display example for table CCTR**

CCNAME	GIVENC	MINDIGSR	MAXDIGSR	TMTORRTE
44 T	044	6	12	T OFRT 6 Y
057 P		6	12	D VACT

### Table history

#### NA004

Entry portion of field MAXDIGSR changed from 0 to 24 to 0 to 25 in NA004. This change accommodates 15-digit international dialing.

The system issues a warning for field MAXDIGSR when the field contains a number larger than 15, not 13. The text of the warning reflects this change.



## CCTRNSL

---

### Table name

Country Code Translation Table

*Note:* This table is active on DMS-300 Gateway switches only.

### Functional description

The switch uses the data in table CCTRNSL to perform the following functions:

- translate the received country code to determine the route the call takes
- replace the pseudo country code with the true country code on outpulsing
- insert the discrimination digit on outpulsing, if the trunk group does not receive a discrimination digit
- update the discrimination digit on outpulsing, if the trunk does receive a discrimination digit

If feature package NTXK08AA (Service Screening—Enhanced) is in the switch, table CCTRNSI can screen the call. Table CCTRNSI uses the datafill in table SERVPROF to screen the call.

### T101 to Gateway calls

A T101 to Gateway call is a call that is incoming to the DMS-300. This call is incoming to the DMS-300 on a T101 trunk and outgoing on any Gateway (GW) trunk. An example of the affect of this type of call on language digits and common calling party categories (CCPC) appears in the following description. The description describes how language and digits and CCPCs on this type of call. This type of call affects the following GW trunks:

- CCITT No.5
- CCITT No.6
- CCITT No.7, this condition excludes telephone user part [TUP] plus [TUP+]
- Austrian TUP (ATUP)
- T3MFC (multifrequency compelled)

The R1 is a GW trunk. The R1 does not carry language digit information in the signaling information or digit stream.

---

**CCTRNSL** (continued)

---

On the incoming side of the call, the stat of the CCPC is test. The type of signaling the outgoing side of the call uses does not affect this condition. The CCPC remains set to test. The system uses this value through translations unless an update of the value in table IDIGCTL occurs

The call detail recording (CDR) record is on the outgoing side. The CDR record applies to CDR format 08 only. On the outgoing side, the system outpulses or sends the language digit or CPCI in the signaling information.

In the following T101 to Gateway call description an update of the CCPC in table IDIGCTL does not occur. On the outgoing side, different results occur when an update to the language digit in table CCTRNSL occurs for one call and not for another call.

**Non-update of the language digit**

The state of the CCPC, set on the incoming side, is test. The T101 does not receive a language digit. The state of the language digit is subscriber. The CCPC functions on the outgoing side to map to an outgoing language or CPCI digit. This selection depends on the involved signaling system.

The system updates the CDR record with the CCPC of test and a language digit of subscriber.

**Update of the language digit**

The results depend on the outgoing signaling system. The CCPC is set to test at the start of the call. Table CCTRNSL can set the language digit to a digit that is not the subscriber. If this condition occurs different results occur for different outgoing signaling system. The following results occur for each outgoing signaling systems:

**CCITT No.5**

The language digit can be 1, 2, 3, 4, 5, or 7 (operator or test) in CCTRNSL. When this event occurs the system outpulses that language digit in the CCITT No.5 digit stream. The system updates the CDR record with a CCPC of test and the language digit set in CCTRNSL.

When the language digit is not one of the above values, the CCPC of test calls the mappings that table 1 describes. The CCPC of test calls the mappings to determine a language digit to outpulse. The system updates CDR record with a CCPC of test and the language digit set in CCTRNSL.

**CCITT No.6 and No.7**

The language digit can be 1, 2, 3, 4, 5, or 13 (operator or test) in CCTRNSL. If this condition occurs the CPCI is set in the signaling information. The

**CCTRNSL** (continued)

system updates CDR record with a CCPC of test and the language digit set in CCTRNSL.

If the language digit is not one of the above values, the CCPC of test calls the mappings that table 1 describes. The CCPC of test calls the mappings to determine a CPCI to set in the signaling information. The CDR record updates with a CCPC of test and the language the digit set in CCTRNSL.

**ATUP/T3MFC**

The CCPC is set to test at the start of a call. If the language digit is set in CCTRNSL the language digit sets the value in the CDR record only. A CCPC of test calls the mappings in table 1. The updated state of the language digit does not affect this condition. The value that results from the mappings sets the A party category on the outgoing side.

**R1**

The R1 does not have a language digit in the digit stream. The R1 does not have a language digit in the signaling information. The CCPC is set to test at the start of the call. If the language digit is set in CCTRNSL, the CDR record reflects the language digit. The CDR record reflects a CCPC of test. The system does not send the values on the outgoing side.

**CCPC mapping to outgoing information digit (Sheet 1 of 2)**

Values	Definition	T3MFC	ATUP	CCITT No.5	CCITT No.6, No.7
0	Unknown source	2/7	10	10	10
1	National subscriber	2/2	21	10	10
2	National subscriber with priority	2/2	21	10	11
3	Test equipment	2/4	13	7	13
4	Spare	2/7	10	10	10
5	National operator	2/1	9	2	2
6	Data equipment	2/7	12	9	12
7	Overseas subscriber	2/7	10	10	10
8	Overseas operator	2/8	2	2	2
9	Alternate voice or data equipment	2/7	10	10	10

**CCTRNSL** (continued)**CCPC mapping to outgoing information digit (Sheet 2 of 2)**

Values	Definition	T3MFC	ATUP	CCITT No.5	CCITT No.6, No.7
10	Subscriber with CLI	2/7	10	10	10
11	Coin box	2/7	10	10	10
12	Overseas subscriber with priority	2/7	11	10	11
13	Spare	2/7	10	10	10
14	Spare	2/7	10	10	10
15	Spare	2/7	10	10	10

**Datafill**

Datafill for table CCTRNSL appears in the following table.

**Field descriptions (Sheet 1 of 5)**

Field	Subfield or refinement	Entry	Explanation and action
CCNAME		see subfields	<i>Country code and country code translation name.</i> This field contains subfields CCTRNM and CC.
	CCTRNM	alphanumeric (4 characters)	<i>Country code translation name.</i> Enter the country code translation name that the operating company defines.
	CC	0 to 9 (a maximum of 18 digits)	<i>Country code.</i> Enter the country code that the Gateway office receives. The country code the Gateway office receives can be a true or pseudo country code.

**CCTRNSL** (continued)

## Field descriptions (Sheet 2 of 5)

Field	Subfield or refinement	Entry	Explanation and action
DISD		alphanumeric (0 to 9, B to F, N)	<p><i>Discrimination digit or calling-party category indicator (CPCI)</i>.. When trunk group does not receive a discrimination digit, enter the value of the discrimination digit. The system must insert this digit as a suffix to the country code. When the trunk group does not receive a calling party category indicator (CPCI), enter the value of the CPCI to insert in the initial address message (IAM) header. This header is CCITT No.6 signaling. The relationship between the entry and the decimal value appears below.</p> <p>Entry</p> <p>1 to 9</p> <p>0</p> <p>B</p> <p>C</p> <p>D</p> <p>E</p> <p>F</p> <p>If the trunk group does receive a discrimination digit or CPCI, enter 0 (zero).</p>
UPDISD		1 to 9, 0, B, C, D, E, or F	<p><i>Update discrimination digit or calling-party category indicator</i>. The trunk group can receive a discrimination digit or a CPCI that is not 0 (zero) or not equal to the value in field UPDISD. If the value in field UPDISD is not equal to 0 (zero), the system replaces the discrimination digit or CPCI. The system replaces the discrimination digit or CPCI with the value in field UPDISD.</p> <p>The relationship between the entry and the decimal value appears below.</p>

**CCTRNSL** (continued)**Field descriptions (Sheet 3 of 5)**

Field	Subfield or refinement	Entry	Explanation and action
			Entry 1 to 9 0 B C D E F  If an update is not a requirement, enter 0 (zero).  If the trunk group does not receive discrimination digit (or CPCI), enter 0 (zero).
TCC		0 to 9 (a maximum of 18 digits)	<i>True country code.</i> Enter the true country code of the country.
TMTORRTE		see subfield	<i>Treatment or route.</i> This field contains subfield TRCD.

**CCTRNSL** (continued)

## Field descriptions (Sheet 4 of 5)

Field	Subfield or refinement	Entry	Explanation and action
	TRCD	D, N, or T	<p><i>Table route call treatment selector.</i> Enter one of the following:</p> <p>If the call routes with office treatment, enter D and enter data into refinement TREAT.</p> <p>If the call requires additional translation in the overseas number translator (OVNTRNSL), enter N. Refinements do not require datafill. Go to field LONGHAUL.</p> <p>If the call routes through table and index, enter T and enter data in refinements TABID and SCRNCTL.</p> <p>Refinements SCRNCTL and SERVPROF are present when package NTXK08AA (Service Screening—Enhanced) is in the switch.</p> <p><b>Note:</b> If a call routes to tables OVR0 to OVR9, or table IDIGCTL, the call must have routed from table INPRTRNS. The call must have routed from table INPRTRNS to have the minimum and maximum digit count set. If the call do not route from table INPRTRNS, the call routes to treatment. If the call does not route from the table INPRTRNS, the call must route to tables MMA0 to MMA9. Tables MMA0 and MMA9 set the minimum and maximum digit count.</p>
	TABID	IBNRT2, IBNRT3, IBNRT4, IBNRTE, IDIGCTL, MMA0 to MMA9, OFR2, OFR3, OFR4, OFRT, OVR0 to OVR9, RRTE, or TTL4	<p><i>Table identifier.</i> If the entry in field TRCD is T, enter data into this refinement. Enter the table that the call routes to and enter data in refinements KEY and DEST.</p> <p>Entries out of the range specified for this field are not correct.</p>

**CCTRNSL** (continued)**Field descriptions (Sheet 5 of 5)**

Field	Subfield or refinement	Entry	Explanation and action
	KEY	1 to 4095	<p><i>Key.</i> Enter the index in the table specified in field TABID.</p> <p>The entry in field TABID can be OVR0 to OVR9, or MMA0 to MMA9. If this event occurs, the entries range from 1 to 1023.</p> <p>If the entry in field TABID is IDIGCTL, the entries range from 1 to 4095.</p>
	DEST	alphanumeric (a maximum of 16 characters)	<p><i>Traffic destination name.</i> Enter the destination names that table DESTNM defines.</p>
	SCRNCTL	Y or N	<p><i>Screening control.</i> If the entry in field TRCD is T, and the switch contains package NTXK08AA, enter data into this refinement. Enter Y (yes) for service screening by destination. Enter data in refinement SERVPROF. If you do not require service screening by destination, enter N (no).</p>
	SERVPROF	alphanumeric (a maximum of 16 characters)	<p><i>ISDN service profile.</i> If the entry in field SCRNCTL is Y, enter data in this refinement. Enter a service profile name that table SERVPROF defines.</p> <p>If the destination does not allow services, enter NULL.</p>
	TREAT	alphabetic (4 characters)	<p><i>Treatment.</i> If the entry in field TRCD is D, enter data in this refinement. Enter the office treatment that the call routes to.</p>
LONGHAUL		Y or N	<p><i>Long haul.</i> This entry identifies if the classification of the destination is long haul for echo suppression switching purposes. The classification of the destination is long haul if the distance to the destination is greater than 2500 km. Enter Y if the classification of the destination is long haul. If the classification of the destination is not long haul, enter N.</p>



## CCTRNSL (end)

---

### Datafill example

Datafill for table CCTRNSL appears in the following example.

Feature package NTXK08AA is in the switch.

### MAP example for table CCTRNSL

	CCNAME	DISD	UPDDISD		TCC
				TMTORRTE	LONGHAUL
	CC00	992	2	0	599
T	OVR0	14	HOL10	Y	EUROPTT
					Y

**CCVAGRMT****Table name**

Calling Card Validation Agreement Table

**Functional description**

Each service provider can have different billing agreements with a given service provider based on the billing method. New table CCVAGRMT provides tracking of billing agreements separately based on Calling Card Validation. Table CCVAGRMT lists the billing agreements between an originator's billing agreement group and a billed-to AO or BSP SPID for calling card validation.

**Datafill sequence and meaning**

Tables SPID and BAGNAME must be datafilled before table CCVAGRMT.

**Table size**

0 to 32765 tuples.

**Datafill**

The table that follows lists datafill for table CCVAGRMT.

**Field descriptions (Sheet 1 of 2)**

Field	Subfield	Entry	Explanation and action
CCVKEY		see subfields	Calling card validation key. This field is the key to the table and consists of subfields ORIGGRP and BILLSPID. The presence of a tuple in this table indicates an agreement exists between the billing agreement group of the originator and the billed-to SPID.

**CCVAGRMT** (end)

**Field descriptions (Sheet 2 of 2)**

Field	Subfield	Entry	Explanation and action
	ORIGGRP	name from table BAGNAME	Originating group. This field is the billing agreement group name associated with the originating party. For an LEC call, this group name is associated with a SPID in table SPIDDB. For a carrier call, this group name is associated with a CIC in table TOPEACAR. The name must be defined in table BAGNAME.
	BILLSPID	value from table SPID	Billed-to SPID. Enter the AO or BSP SPID of the billed-to party/entity. The SPID must be defined in table SIPD. The SPID returned from the LIDB query is compare to this field to screen for billing agreements.

**Datafill example**

The figure that follows shows sample datafill for table CCVAGRMT.

**MAP display example for table CCVAGRMT**

CCVKEY	
OPRCCVGRP	LECA
OPRCCVGRP	LECB
OPRCCVGRP	C111
OPRCCVGRP	C222
LECCCVGRP	LECC
LECCCVGRP	LECD
LECCCVGRP	C333
LECCCVGRP	C444

**Table history**  
**TOPS13**

This table is added by feature 59011929 in functionality Screening for Billing Agreement, UNBN0007.

---

**CCVINFO**

---

**Table name**

Calling Card Verification Information Table

**Functional description**

Table CCVINFO is used for calling card verification (CCV) queries. This table is indexed with both domestic 14-digit (NPA-NXX or RAO-0/1XX) and International Telephone and Telegraph Consultative Committee (CCITT) calling card numbers and contains an index into table CCVPARMS. This enables both card types to index the same tuple in table CCVPARMS. Table CCVPARMS contains datafillable fields relating to EABS CCV queries and responses. If a given calling card has no match in this table, then tuple 0 (the default tuple) in table CCVPARMS is used.

The key field is CCVDIGS.

**Datafill sequence and implications**

Tables CCVPARMS and CARRSCRN must be datafilled before table CCVINFO. The value used in field PARMSIDX of this table must first exist as the value of field IDX in table CCVPARMS.

This table must be datafilled before table INTCCFMT. For CCITT calling cards, field CCDIGS must be datafilled here prior to being datafilled in table INTCCFMT.

**Table size**

0 to (see note)

*Note:* This table uses digilators and therefore the maximum number of tuples depends on how the table is datafilled, and this varies with each application.

## CCVINFO (continued)

### Datavfill

The following table lists the datavfill for table CCVINFO.

#### Field descriptions

Field	Subfield or refinement	Entry	Explanation and action
CCVDIGS		1 to 18 digits (each digit ranges in value from 0 to 9)	Calling Card Digits. Key to the table. This field is a digilator. For CCITT cards the ID must be datavfilled here prior to being datavfilled in table INTCCFMT, field ISSUERID. For domestic cards, enter the 14-digit calling card number, or a portion of the digits covering a range of cards (NPA-Nxx or RAO-O/1xx digilator). This is the key field to table CCVINFO.
PARMSIDX		0-300	Table CCVPARMS index. An index into table CCVPARMS. Entries must exist in field IDX in table CCVPARMS. This field allows more than one CCDIGS to index the same tuple in table CCVPARMS, thus reducing the number of tuples required in table CCVPARMS.
CARRIDX		0-62	Carrier index.

Subsequent dump and restore should copy existing table values from this table.

### Datavfill example

The following example shows sample datavfill for table CCVINFO.

#### MAP display example for table CCVINFO

CCDIGS	PARMSIDX
2	254
891222	3
891333	0
8915555	0
919	1

### Table history

#### BCS34

Table CCVINFO was introduced. Then modified by feature NC0342 in package NTX825AB, TOPS EABS.

## Supplementary information

This section provides information on datafilling table CCVINFO for specific applications, and product descriptive information related to table CCVINFO.

Initially, if optional package NTXE72AA is present (and therefore table INTCCFMT), field CCDIGS is copied here from table INTCCFMT, field ISSUERID. Field PARMSIDX is determined by the value of fields GTTNAME, CLDNUM (CLDREQ), TIMEOUT, SEQQRY, and QRYBLK (of table INTCCFMT). If the value of the those fields match an existing tuple in table CCVPARMS, the index for that tuple should be used in table CCVINFO. Otherwise, a new tuple must be added to table CCVPARMS and its index should be used in table CCVINFO. Subsequent dump and restore actions copy existing table values.

## CCVPARMS

---

### Table name

Calling Card Verification Parameters Table

### Functional description

Table CCVPARMS is used for LIDB queries. It provides an index into table ACCSERR for calling card validation (CCV) information for both public and private phones. This allows different handling (for the same error codes) for public and private phones.

*Note:* A telephone is considered a private phone if the call is classed as "station." For any other class (i.e., hotel, restricted, coin), the phone is considered to be a public phone.

The datafill in table CCVPARMS determines how the Traffic Operator Position System (TOPS) reacts to abnormal line information database (LIDB) queries including time-outs, signaling connection control port (SCCP) errors, and transaction capabilities application part (TCAP) errors in Common Channel Signaling 7 (CCS7) protocol.

Table CCVINFO uses table CCVPARMS to provide a single index into table ACCSERR for multiple tuples entered in table CCVINFO. Tuple 0 is a default and is used by EABS when a tuple cannot be found in table CCVINFO (and, as a result, table CCVPARMS) for a given calling card or billed number.

Fields GTTNAME, CLDREQ, TIMEOUT, and SEQQRY are moved here from table INTCCFMT. All functions provided by these fields are now available for both CCITT and 14-digit (NPA-NXX or RAO-0/1XX) calling cards, since table CCVINFO is the index into table CCVPARMS.

Table CCVPARMS uses table C7GTTYPE for global translation of billed numbers (BN).

The key field is IDX.

### Datafill sequence and implications

The following tables must be datafilled before table CCVPARMS:

- C7GTTYPE
- ACCSERR

Table CCVPARMS must be datafilled before tables CCVINFO.

**CCVPARMS** (continued)**Table size**

1 to 255 tuples

**Datafill**

The following table lists the datafill for table CCVPARMS.

**Field descriptions (Sheet 1 of 3)**

Field	Subfield or refinement	Entry	Explanation and action
IDX		0-300	Index. Table key. This field is the key to the table and is indexed from table CCVINFO, field PARMSIDX.  The default value is 0. The default value is used by the exchange alternate billing service (EABS) if a tuple for a given calling card or BN cannot be found in tables CCVINFO and CCVPARMS.
VALAREA		see subfield VALTYPE	Validation area. This field is composed of selector field VALTYPE and a set of other subfields based on the value of VALTYPE.
	VALTYPE	MANUAL, BLK, SDB, or LIDB, BVC	Validation type. Selector VALTYPE determines the method of validating the collect or third number. Only when VALTYPE=LIDB do the remaining fields (GTTNAME, CLDREQ, TIMEOUT, SEQQRY, PUBCCV, and PRIVCCV) appear. The default is LIDB. The entries are defined as follows: <ul style="list-style-type: none"> <li>MANUAL - Inward validation is required by an operator.</li> <li>BLK - Table BNSPARMS is indexed by an alternate billing number, then alternate billing to this number is blocked.</li> <li>SDB - Validation by network services database.</li> <li>LIDB - Validation by line information database.</li> <li>BVC - Billing validation center</li> </ul>

Note: The following fields (GTTNAME, CLDREQ, TIMEOUT, SEQQRY, PUBCCV, and PRIVCCV) only appear if field VALTYPE=LIDB.



**CCVPARMS** (continued)

## Field descriptions (Sheet 2 of 3)

Field	Subfield or refinement	Entry	Explanation and action
	GTTNAME	string of up to 16 characters	<p>Global Title Translation Name. Enter a value from field GTTNAME in table C7GTTYPE. Table C7GTTYPE must be datafilled prior to datafilling a string (other than the empty string) in field GTTNAME of this table.</p> <p>The default value is ACCSGT.</p>
	CLDREQ	Y or N	<p>Called Number Required. Enter Y (yes) to require the inclusion of the called number in the LIDB query; otherwise, enter N (no).</p> <p>This value indicates if the card issuer requires the called number to be included in the query. If this field is set to Y(es), we will wait to send the validation query until the operator has obtained a forward number. Instances in which the called number cannot be obtained are:</p> <ul style="list-style-type: none"> <li>• operator-handled directory assistance calls</li> <li>• inwards validation calls.</li> </ul> <p>In these instances, the query is sent with the called number having the value of all zeroes and the verification is left to the card issuer.</p> <p>The called number required parameter only applies to subscriber originated TA calls. For all other call types, a query is sent as soon as possible (i.e., when a calling card number is present and the call is properly class charged).</p> <p>The default value is N.</p>

**CCVPARMS** (continued)**Field descriptions (Sheet 3 of 3)**

Field	Subfield or refinement	Entry	Explanation and action
	TIMEOUT	0-255	<p>Timeout. Enter the time in seconds that the operator services system (OSS) waits for a response from a LIDB query on a card issuer basis. If the response is not received within this time, the OSS terminates its wait for the response.</p> <p>This field is useful because the time between the launch of a LIDB query and the receipt of the response message in the OSS may vary for different card issuers (which may use different LIDBs).</p> <p>The default value is 2.</p>
	SEQQRY	Y or N	<p>Sequence Query. When set to Y(es), a query is sent on every sequence call for the given card issuer.</p> <p>The default value is N.</p>
	PUBCCV	0-254	<p>Public Index (for CCV queries). An index into table ACCSERR for a calling number that is a public telephone.</p> <p>The default value is 0.</p>
	PRIVCCV	0-254	<p>Private Index (for CCV queries). An index into table ACCSERR for a calling number that is a private telephone.</p> <p>The default value is 0.</p>

**Datafill example**

The following example shows sample datafill for table CCVPARMS.

**CCVPARMS** (continued)**MAP display example for table CCVPARMS**

IDX	VALAREA				
0	LIDB	\$ N	2 N	0	0
10	LIDB	\$ N	2 N	0	10
297					BVC
298					SDB
299					BLK
300					MANUAL

The above example shows default tuple 0.

**Table history****TOPS03**

Added field VALAREA and subfield VALTYPE, from feature AN0409 in TOPS Commercial Credit Card, ABS00008.

**BCS35**

Updates were added to support global Automatic Calling Card Service (ACCS).

**BCS34**

Table CCVPARMS was introduced. And modified by feature AN0342 in NTX825AB, TOPS EABS.

**Supplementary information**

This section provides information on datafilling table CCVPARMS for specific applications, and product descriptive information related to table CCVPARMS.

One default tuple (tuple 0) is present when the table is introduced.

If table INTCCFMT is present, dump and restore action copies the values from fields GTTNAME, TIMEOUT, and SEQQRY in table INTCCFMT to the fields of the same name in table CCVPARMS. The value from field CLDNUM in table INTCCFMT is copied into field CLDREQ in table CCVPARMS.

Tuple 0 fields TIMEOUT and SEQQRY replace office parameters ACCS\_QUERY\_TIMEOUT in table OFCENG and ACCS\_SEQ\_QUERY in table OFCVAR. Office parameter dump and restore from BCS34 to BCS35 modifies tuple 0 to the parameter values.

**CCVPARMS** (end)

---

Subsequent dump and restore actions copy the existing table values.

Table C7GTTYPE must be datafilled prior to datafilling a string (other than the empty string) in field GTTNAME.

---

## CCVPROV

---

### Table name

Calling Card Validation by Provider

### Functional description

This table is used to obtain the index into table CCVPARMS for calls billed to a domestic calling card. Table CCVPROV is used instead of table CCVINFO when the UNBN0104 SOC and LIDBYCIC fields are active, and the UNBUNDLING\_LIDB\_QUERY\_ROUTING parameter in table TOPSFTR is set to yes.

This table is created as a result of the LIDB Query Routing Based on CIC feature. The capability of determining which LIDB to query based on the Carrier Identification Code (CIC) and billing number associated with the call is provided by this feature. This functionality is activated on a per-CIC basis through table TOPEACAR, and only applies to calls originated from a carrier. Enhancements are also made to the release line trunk (RLT) protocol to signal the International organization for standardization (ISO) card information back to the DMS-250 in the facility request message (FAR).

### Datafill sequence and meaning

Table CCVPROV (Calling Card Validation by Provider) is used to obtain the index into table CCVPARMS for calls billed to a domestic calling card. Table CCVPROV is used instead of table CCVINFO when the UNBN0104 SOC and the LIDBYCIC field are active. The PARMSIDX datafilled in table

## CCVPROV (end)

CCVPROV must first be defined in table CCVPARMS. The datafill sequence is as follows.

- CCVPARMS
- LDBIDXNM
- TOPEACAR
- CCVPROV

### Datafill

The next table lists the datafill for table CCVPROV.

#### Description of table CCVPROV

Field Name	Subfield	Entry	Explanation
CCVKEY			Two part key consisting of the index from table TOPEACAR and the calling card digits.
	LIDBIDX	Up to eight alphanumeric characters.	Index from table TOPEACAR.
	BILLDIGS	Digits.	Enter the calling card digits.
PARMSIDX	Digits		Provides the index into table CCVPARMS.

### Datafill example

The next figure shows sample datafill for table CCVPROV.

#### MAP display example for table CCVPROV

	CCVKEY	PARMSIDX
CAR111	20	0
CAR111	212	0
CAR111	3	0
CAR222	3	1
CAR222	4	1

### Table release history

Table CCVPROV is a new table for the TOPS16 release.







DMS-100 Family  
**North American DMS-100**  
Customer Data Schema Reference Manual  
Volume 2 of 12  
Data Schema AUDALARM-CCVPARMS

Product Documentation - Dept. 3423  
Nortel Networks  
P.O. Box 13010  
RTP, NC 27709-3010  
Telephone: 1-877-662-5669  
email: [cits@nortelnetworks.com](mailto:cits@nortelnetworks.com)

Copyright © 1996-2001 Nortel Networks,  
All Rights Reserved

**NORTEL NETWORKS CONFIDENTIAL:** The information contained herein is the property of Nortel Networks and is strictly confidential. Except as expressly authorized in writing by Nortel Networks, the holder shall keep all information contained herein confidential, shall disclose the information only to its employees with a need to know, and shall protect the information, in whole or in part, from disclosure and dissemination to third parties with the same degree of care it uses to protect its own confidential information, but with no less than reasonable care. Except as expressly authorized in writing by Nortel Networks, the holder is granted no rights to use the information contained herein.

Information is subject to change without notice. Nortel Networks reserves the right to make changes in design or components as progress in engineering and manufacturing may warrant. Changes or modification to the DMS-100 without the express consent of Nortel Networks may void its warranty and void the user's authority to operate the equipment.

Nortel Networks, the Nortel Networks logo, the Globemark, How the World Shares Ideas, Unified Networks, DMS, DMS-100, Helmsman, MAP, Meridian, Nortel, Northern Telecom, NT, Supernode, and TOPS are trademarks of Nortel Networks.

Publication number: 297-8021-351  
Product release: LET0015 and up  
Document release: Standard 05.02  
Date: May 2001  
Printed in the United States of America

